

Recommended Prices

Ex. VAT - EUR - July 2026

Version - 2026.3



Fredericia







Content

Visual index	04
Material information	10
Fredericia Standard Fabrics	12
Textile supplier overview	13
Fredericia Leather	14
Leather supplier overview	15
Customer Care & C.O.M. upholstery	16
Table size seating overview	17
Terms & Conditions of Sale and Delivery	19
Pricelist	
Chairs & stools	23
Lounge chairs	125
Sofas	178
Tables	273
Coffee & Side Tables	322
Storage	362
Complements	367
Material Samples & Care Kits	387











Chairs & Stools

COLLECTION	PAGE
BM61 & BM62 Borge Mogensen	24
Eyes Johannes Foersom & Peter Hiort-Lorenzen	28
Flamingo Johannes Foersom & Peter Hiort-Lorenzen	33
Gomo Armchair Hugo Passos	34
J39 Mogensen Chair Borge Mogensen	39
Klint Chair Kaare Klint	43
Lynderup Chair Borge Mogensen	45
Mogensen Bench & Chair Borge Mogensen	50
Pato 4 Leg Welling/Ludvik	53
Pato Sledge Welling/Ludvik	57
Pato Swivel & Office Welling/Ludvik	64
Pato Executive Welling/Ludvik	68
Pato Paper Welling/Ludvik	69
Pioneer Maria Bruun	84
Plan Armchair Edward Barber & Jay Osgerby	87
Plan Chair Edward Barber & Jay Osgerby	89
Plan Wood Chair Edward Barber & Jay Osgerby	95
Post Cecilie Manz	97













Chairs & Stools

COLLECTION		PAGE
The Spanish Dining Chair Borge Mogensen		99
Søborg Borge Mogensen		102
Spine Wood Base Space Copenhagen		109
Swoon Dining Space Copenhagen		111
Trinidad Nanna Ditzel		113
Trisse Stool Nanna Ditzel		123

Lounge Chairs

COLLECTION		PAGE
A-Chair Jens Risom		126
Bench for Two Nanna Ditzel		128
Canvas 21 Chair Borge Mogensen		130
The Canvas Chair Borge Mogensen		132
Corona Chair Poul M. Volther		136
Ditzel Lounge Nanna Ditzel		138
Eyes Lounge Johannes Foersom & Peter Hiort-Lorenzen		140
Gomo Lounge Hugo Passos		144
The Hunting Chair Borge Mogensen		146
Jota Lounge Chair Jasper Morrison		148

Lounge Chairs

COLLECTION		PAGE
Mogensen 22 Collection Børge Mogensen		150
Mono Birgitte Due Madsen & Jonas Trampedach		153
Pato Lounge Welling/Ludvik		155
Post Lounge Cecilie Manz		156
Savannah Monica Förster		158
The Spanish Chair Børge Mogensen		160
Spine Lounge Space Copenhagen		162
Swoon Lounge Space Copenhagen		164
Wegner 1788 Lounge Chair Hans J. Wegner		168
Wegner J16 Rocking Chair Hans J. Wegner		170
Wegner Ox Chair Hans J. Wegner		174
Wegner Queen Chair Hans J. Wegner		176





Sofas

COLLECTION		PAGE
Calmo Hugo Passos		179
Delphi Hannes Wettstein		194
EJ220 Erik Jørgensen	 ERIKJØRGENSEN	218
EJ280 Erik Jørgensen Studio	 ERIKJØRGENSEN	222



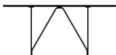

Sofas

COLLECTION		PAGE
EJ315 Erik Ole Jørgensen		235
Gomo Sofa Hugo Passos		238
Jota Sofa Jasper Morrison		240
Konami Damian Williamson		245
Mogensen 22 Collection Børge Mogensen		249
Mogensen 23 Collection Børge Mogensen		255
Nami Damian Williamson		257
No.1 Børge Mogensen		264
Savannah Monica Förster		266
Spine Space Copenhagen		268
The Spoke-Back Sofa Børge Mogensen		269







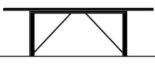

Tables

COLLECTION		PAGE
BM71 Library Table Børge Mogensen		274
BM80 Mogensen Shaker Table Børge Mogensen		275
Mogensen Dining Tables Børge Mogensen		277
Islets Maria Bruun		287
JG Table Jørgen Gammelgaard		288

Tables

COLLECTION		PAGE
Plan Table Edward Barber & Jay Osgerby		290
Plan Wood Table Edward Barber & Jay Osgerby		308
Plan Table, Column Edward Barber & Jay Osgerby		310
Post Cecilie Manz		315
Trisse Table Nanna Ditzel		318

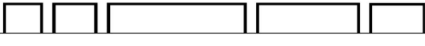
Coffee & Side Tables

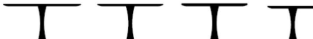
COLLECTION		PAGE
BM67 Coffee Table Borge Mogensen		323
BM80 Mogensen Coffee Table Borge Mogensen		324
Insula Anne-Mette Bartholin Jensen & Morten Ernst		326
Islets Maria Bruun		330
JG Coffee Table Jorgen Gammelgaard		332
Niveau Cecilie Manz		333
Pal Keiji Takeuchi		336
Piloti Hugo Passos		338
Pon Jasper Morrison		347
Tableau Space Copenhagen		351
Trisse Coffee Table Nanna Ditzel		354











Coffee & Side Tables

COLLECTION		PAGE
Wegner Ox Table Hans J. Wegner		358

Storage

COLLECTION		PAGE
BM29 Shelf Borge Mogensen		363

Complements

COLLECTION		PAGE
BM Nesting Tables Borge Mogensen		368
Gallery Hans Sandgren Jakobsen		369
JG Folding Stool Jorgen Gammelgaard		370
Magazine Table Jens Risom		371
ND09 Coat Stand Nanna Ditzel		372
Pioneer Maria Bruun		373
Seto Stool Keiji Takeuchi		374
Sequoia Space Copenhagen		375
Silhouette OEO Studio		376
Tadaima x Fredericia Collection Tadaima		380
Trisse Stool Nanna Ditzel		385

Wood surfaces

Material and surface may refer to both solid wood and outer layer on plywood or veneered table tops. Oak, ash and beech are sourced from sustainably managed European forests. Walnut is American walnut. Not all products are available in all materials.



WOOD	FINISH	DESCRIPTION
Oak	Oak soap	Treated with natural soap flakes. Light colour gets patina and darkens over time
	Oak lacquered	Clear lacquer, slightly white pigmented
	Oak oil	Clear natural oil with darkening effect on the natural colour tone of oak
	Oak light oil	Clear natural oil slightly pigmented, preserving the natural light colour tone of oak.
	Smoked oak, oiled	Fumed oak with clear natural oil treatment. Brown colour tone where large colour differences occur between wooden parts. The dark colour lightens with sunlight.
	Smoked oak stained, lacquered	Stained in smoked oak colour and finished with matt lacquer. The natural surface of the wood is visible through the stain.
	Oak black lacquered	Finished with black lacquer preserving wooden grain structure.
Ash	Ash oil	Clear natural oil with darkening effect on the natural colour tone of oak.
	Ash brown stained	Stained in dark colour. The natural surface of the wood is visible through the stain.
	Black ash	Finished with black lacquer preserving wooden grain structure
Beech	Beech soap	Treated with natural soap flakes, light colour gets patina and darkens over time.
	Beech lacquered	Clear lacquer
	Beech oil	Clear natural oil
	Beech vintage lacquered	Finished with a slightly brown pigmented lacquer, darkening the surface of the wood.
	Beech dark brown lacquer	Finished with a dark brown pigmented lacquer.
	Beech standard lacquered colours	Finished with a coloured lacquer which limits the visibility of the wooden grain structure. Only available for Trinidad and J39. The specific colours can be seen under each product.
Walnut	Walnut lacquered	Clear lacquer
	Walnut oiled	Clear natural oil
Oregon Pine	Oregon Pine lacquered	Finished with a slightly brown pigmented lacquer, darkening the surface of the wood.

Metal Surfaces

Not all models are available in all colours. Customised finishes are available, subject to quotation.

NAME	DESCRIPTION
Brushed stainless steel	Stainless steel, brushed finish. Appearance match other brushed finishes.
Brushed chrome	Brushed, then chromed steel. Appearance match other brushed finishes.
Brushed aluminium	Aluminium with brushed finish. Appearance match other brushed finishes.
Chrome	Chrome plated (chrom III), occasionally in combination with polished aluminium.
Polished aluminium	Shiny polished aluminium. Appearance match chrome finish.
Matt chrome	Chrome plated (Chrom III), satin chromed.
Black	Powder coated RAL 9005.
Flint	Powder coating with metallic effect, gunmetal colour.

Material information

Standard Colours

The Standard Colours are applied to coloured-through recycled polypropylene (PP) and certain woods, as well as powder coats. Customised colours are available for an extra charge. Customer approval of the test is required before production start-up.

COLOUR NAME	COLOUR CODE	J39 MOGENSEN CHAIR	TRINIDAD	PLAN CHAIR & TABLE	PATO	PIONEER
Black	RAL 9005	•	•	•	•	
White	RAL 9016	•			•	
Dark grey	NCS S 8000 N				•	
Stone	NCS S 3502 B				•	
Sand	NCS S 2005 Y30R				•	
Quartz grey	RAL 7039				•	
Storm	NCS S 5020 R90B				•	
Ancient green	NCS S 8010 B50G				•	
Ocean	NCS S 3010 B90G				•	
Dark red	NCS S 5540 Y90R				•	
Modernist green	NCS S 5020-G30Y			•		
Bordeaux, metal	NCS S 7020-R10B			•		
Bordeaux, wood	NCS S7020-R					•
Chalk	NCS S 1505-Y			•		
Signal blue	NCS S 4050B			•		
Heritage red	NCS S 4550-Y60R	•				
Indigo blue	RAL 5011	•				
Khaki green	NCS S 7010-G70Y	•	•			
Pebble grey	NCS S 3005-Y50R	•				
Nordic blue	NCS S 8010-R90B		•			

Laminate & linoleum

Not all models are available in all colours. Customised finishes are available, subject to quotation.

MATERIAL	COLOUR CODE	JG TABLE	PLAN TABLE
Fenix NTM laminate, black	Fenix 0720		•
Linoleum, black		•	•
Linoleum, grey		•	
Really, Cotton Cream			•

Stone

Marble and limestone are natural materials where two surfaces are never alike. The stones can contain sediments from fossils, sand holes, glass veins and porosity and all are indicators of genuine stone while attributing to the natural character of the surface. Not all models are available in all surfaces. Marble is not flexible and won't respond well to heavy loading. Never sit or stand on your marble tabletop and avoid placing particularly heavy items on it. Max load is 20 kgs.

NAME	DESCRIPTION
Black Marquina Marble	Black Marquina is an elegant marble with a matt, black surface with natural strong white veins. The intense marble takes its name from the quarries around the town of Marquina from which it is extracted. The irregular white veins can vary considerably from batch to batch. Black Marquina is sourced from Spain.
White Carrara Marble	White Carrara is a classic white marble with a matt surface, characterised by the occurrence of natural and irregular grey veins. White Carrara has been used for centuries by architects, designers and artists alike. The white surface can vary in tone and the occurrence of grey to almost black veins can likewise vary in quantity and strength. White Carrara is sourced from Italy.
Dark Atlantico Limestone	Dark Atlantico is a limestone with a beautiful natural surface and warm colour tones in umbra grey shades. Possible aspects of fossils and sediments. Large colour differences to be expected. Extremely sensitive to acids, which can leave non-removable marks. Dark Atlantico is sourced from Portugal.
Ivory Quartzite	Ivory Quartzite is a light and elegant stone with a matt ivory surface. The nuances can vary including the possibility of both light and darker veining. Resistant to acids and scratching. Ivory Quartzite is sourced from Brazil.
Tundra Grey Marble	Tundra Grey Marble is an exquisite natural stone with a unique blend of cloud-like grey hues and pearl tones. Its intricate veining patterns create a mesmerizing visual effect with a fine-grained surface which is smooth to the touch. Tundra grey is sourced from Turkey.

Fredericia Standard Fabrics

The Fredericia Standard Fabrics are a range of state-of-the-art upholstery fabrics recommended for the Fredericia product range. Textiles can be supplied in flame-retardant qualities that meet the requirements of the British Standard (BS) and California Technical Bulletin (CAL 117) fire safety law. For extended range of textiles, please see our Textile supplier overview.

*ATTENTION: Velour can have press marks (where pile naps have tendency to lay down) either from transport or in use. This is a typical property of velour and it is not to be seen as a defect.

NAME	COMPOSITION	MARTINDALE	ENVIRONMENTAL	FABRIC GROUP	BRAND
Connect	48% WO / 41% recycled PL / 9% PA / 2% virgin PL	90.000	EU Ecolabel	0	Gabriel
Bardal	70% WO / 30% VI	62.000	EU Ecolabel	1	Gudbrandsdalens Uldvarefabrik
Capture	85% WO / 15% PA	+100.000	EU Ecolabel	1	Gabriel
Grand Linen	100% LI	30.0000	Oeko-Tex 100	1	Fredericia / Libeco
Linara	63% CO / 37% LI	36.000	Oeko-Tex 100	1	Romo
Natural linen	91% / LI / 9% PA	28.000	Oeko-Tex 100	1	Fredericia / Libeco
Remix	90% WO / 10% PA	+100.000	EU Ecolabel	1	Kvadrat
Re-wool	45% WO (45% recycled WO) / 10% PA	100.000	EU Ecolabel	1	Kvadrat
Barnum	45% CO /19% VI / 15% WO / 13% PC / 8% PA	60.000	Oeko-Tex 100	2	Nevotex
Fiord	92% WO / 8% PA	60.000	EU Ecolabel	2	Kvadrat
Hallingdal	70% WO / 30 % VI	+100.000	EU Ecolabel	2	Kvadrat
Loop	46% PAN / 23% WO / 15% CO / 12% PA / 4% PL	60.000		2	Kirkby Design (Romo)
Ruskin	70% VI / 15% LI /10% WO / 5% PA	60.000		2	Romo
Savoy*	100% Trevira CS	+100.000	EU Ecolabel	2	Gabriel
Steelcut trio	90% WO / 10% PA	+100.000	EU Ecolabel	2	Kvadrat
Steelcut Quartet	90% WO / 10% PA	+100.000	EU Ecolabel	2	Kvadrat
Asator	100% CO	80.000	Greenguard Gold	3	Kvadrat
Clay	76% LI / 21% CO / 3% PL	45.000	Greenguard Gold	3	Sahco (Kvadrat)
Divina Melange	100% WO	45.000	EU Ecolabel	3	Kvadrat
Sunniva	58% WO / 25% VI / 8% LI / 5% PA / 4% PL	50.000	Greenguard Gold	3	Kvadrat
Zero	65% CO / 20% PA / 15% PL	70.000	Greenguard Gold	3	Sahco (Kvadrat)
Vidar	94% WO / 6% PA	+100.000	EU Ecolabel	3	Kvadrat
Tonus	90% WO / 10% PA	100.000	EU Ecolabel	3	Kvadrat
Cotil 863	54% WO / 44% CO	30.000		4	Cotil
Elle	25% CO / 20% VI / 20% WO / 20% PC / 15% PA	70.000	Greenguard	4	Sahco (Kvadrat)
Safire	43% VI / 17% PAN / 15% WO / 9% CO / 8% PL / 8% LI	+100.000	Greenguard	4	Kvadrat Raf Simons
Sisu	99% WO / 1% PL	70.000	Greenguard Gold	4	Kvadrat
Gentle	60% WO / 20% PA / 20%PL	90.000	Greenguard Gold	5	Kvadrat Febrik
Grand mohair*	100% Mohair (cotton base)	+100.000	Oeko-Tex 100	5	Danish Art Weaving

Textile supplier overview

Textile supplier overview

Shows numerous fabric options graded into the Fredericia price group structure and therefore surpass C.O.M procedure. Not all fabrics shown are suitable for all products, and Fredericia reserves the right to reject certain combinations of fabric and furniture.

For sample swatches please refer to the suppliers.

KVADRAT/SAHCO/FEBRIK	FABRIC GROUP		FABRIC GROUP		FABRIC GROUP
Floyd	0	Encircle	2	Beda	4
Guest	0	Ecriture	2	Moss	4
Ame	1	Keiga	2	Byram	5
Diade	1	Haku	3	Helia	5
Sport	1	Kumo	3	Ria	5
Technicolour	1	Nalia	3		
Canvas	2	Saxion	3		

GABRIEL	FABRIC GROUP		FABRIC GROUP	NEVOTEX	FABRIC GROUP
Mood	1	Crisp	2	Erik	1
Passion	1	Focus / Focus Melange	2	Megan	1
Parcel loop	1	Twill wool	2	Njord	1
Select	1	Savak / EJ Savak col. 51	3	Illusion	2
Breeze Fusion	2	Umi	3		

ROMO GROUP	FABRIC GROUP		FABRIC GROUP	GUDBRANDSDALENS ULDFABRIK	FABRIC GROUP
Elio	1	Soho	2	Amdal	2
Smooth	1	Tosca	4	Hemsedal	4
Fleck Eco	2				

DEDAR	FABRIC GROUP	JAB	FABRIC GROUP	VESCOM	FABRIC GROUP
Adamo & Eva	4	City Velvet	2	Acton	1
Karakorum	5			Auckland	2
Voulez Vous	5			Foster	2
				Moore	2

CAMIRA	FABRIC GROUP
Blazer	1
Main Line Flax	1
Yoredale	2

Fredericia Leather

From surface finish to colour range, the leathers in the Fredericia Leather Collection are fine-tuned to complement the product range, both visually and in material tactility. The tanning processes are kept in enclosed systems to minimise local water pollution and environmental impact. All leathers are tanned in Italy or Sweden. Each partner tannery is monitored and supervised to secure Fredericia's ethical and quality standards.

NAME	COLOURS	TYPE	ENVIRONMENTAL	DESCRIPTION	LEATHER GROUP
Vice	11 Black	Pigmented Corrected grain 1,2-1,4 mm	European hides Chrome III tanned in Italy Blau e Engel Ecolabel	The leather surface is corrected with an even grain pattern embossment. Vice is an extremely durable leather. Reduced breathability.	0
Omni	112 Warm grey 293 Burnt sienna 301 Black 307 Cognac 320 Dark clay 377 Dark brown	Semi-aniline, Full grain 1,2-1,4 mm	European hides Chrome III tanned in Italy Blau e Engel Ecolabel	Elegant leather with harmonuous and regular full grain structure and a comfortable touch. User friendly with good protection against dirt and light, while being durable. All Omni colours are available as CRIB5 with pricing in Leather group 2	1 (w/ CRIB5: 2)
Primo	74 Umbra grey 75 Cognac 86-1 Dark brown 88 Black	Semi-aniline Full grain 1,5-1,7 mm	European hides Chrome III tanned in Italy Blau e Engel Ecolabel	Classic full-grain semi-aniline leather made from the best bull hides. A precise protective layer gives a comfortable touch with good breathability, while adding resitance to dirt.	2
Trace	8146 Olive 8175 Black 8680 Heritage brown 8870 Light tan	Semi-aniline Full grain 1,2-1,4 mm	Danish & Swedish hides Processed in Denmark, tanned in Germany. Chrome free Biodegradable & compostable	Trace is a semi-aniline leather developed specifically for Fredericia in Collaboration with Spoor, where the hides are traceable down to the specific animal. The leather is elegant with a rich depth in colour. Comes from the finest sorting of hides limited to Denmark and Sweden.	2
Max	91 Nutshell 92 Tan 93 Indian red 95 Cognac 96 Dark brown 98 Black	Aniline Full grain 1,2-1,4 mm	European hides Chrome III + vegetable tanned in Italy Blau e Engel Ecolabel	Luxurious aniline leather with a natural open-pored texture, made from the absolute top selection bull hides. The leather is highly breathable and comfortable with a smooth surface and tight structure.	3
Cera	905 Russet brown	Aniline Full grain 1,1-1,3 mm	European hides Chrome III tanned in Italy Blau e Engel Ecolabel	A luxurious full-grain aniline leather which has been finished with a light wax resulting in a smooth surface with a silky feel. An open-pored leather that is highly breathable with a tight and elegant structure. Cera is made from the absolute top selection bull hides primarily from Norway and Switzerland.	4
Vegeta	90 Natural	Aniline (uncoloured) Full grain 1,2-1,4 mm	European hides Vegetable tanned in Italy Blau e Engel Ecolabel	Produced from the absolute top selection of hides. Vegeta has a natural open-pored texture, making the leather highly breathable. The leather acquires a unique patina and darkens over time.	4
Organic	906 Mocca	Semi-aniline Full grain 1,1-1,3 mm	Scandinavian hides Vegetable tanned in Sweden Organic content certified	Visible marks and variation in the surface coming from a free-ranging animal life is to be expected. Raw hides are traceable to certified organic cattle.	4
Nubuck	501 Light sand 502 Warm grey 506 Anthracite 512 Olive	Nubuck Sanded full grain 1,2-1,5 mm	European hides Chrome III tanned in Italy Blau e Engel Ecolabel	A full-grain aniline hide has been lightly sanded to obtain an exclusive matte effect. Tanning includes Scotchguard protection.	4

Leather supplier overview

Shows numerous leather options graded into the Fredericia price group structure. Not all leathers shown are suitable for all products, and Fredericia reserves the right to reject certain combinations of leather and furniture. Minimum order quantity required from external leather suppliers is a consumption of at least 5m2.

For sample swatches please refer to the suppliers.

	LEATHER GROUP 1	LEATHER GROUP 2	LEATHER GROUP 3	LEATHER GROUP 4	LEATHER GROUP 5
Stolz (minimum pcs = 5 m2)		Select	Cervo	Velvet	
		Atlas		Vegetal	
Sorensen (minimum pcs = 5 m2)	Ultra crib 5	Triumph Crib 5	Dunes		Excellence
	Nuance	Terra			
		Spectrum			
SPOOR (minimum pcs = 5 m2)	Zea	Fauna	Nohr	Origin	

A leather card of selected Sorensen Leathers can be ordered through Fredericia Customer Care.

We are here to help you

Customer Care & Aftersales

Mon–Thu: 08.00–16.00
Fri: 08.00–15.30

customerservice@fredericia.com
+45 7592 3344

Essential Assortment

Our Essential Assortment is a curated selection of our products which has been pre-configured from our general pricelist. The entire assortment will be available with all required metadata, making it suitable for e-commerce. Our Essential Assortment will be supported thoroughly by image material and have a consistent delivery time.

Important notice:

The Essential Assortment has been pre-configured in all aspects including foam, upholstery, gliders etc. Changes in the configuration is not possible. If this is needed we refer to our general pricelist-matrix.

For upholstered furniture the standard foam will always be HR foam. If CMHR foam (UK approved) is needed this is considered a special variant, and must be configured in the general pricelist-matrix.

Customers Own Materials

Fredericia offers to upholster in custom-specific fabric and leather (C.O.M), after approval from Fredericia's quality department. For fabric and leather not included in Fredericia's standard Fabrics and Graded-in programmes we require a sample of at least 30x30cm. The physical sample and materials should be sent to Fredericia.

The sample must include following information:

- Customer name & contact details
- Manufacturer of material/fabric
- Article name and colour reference
- Applicable Fredericia product

Please be aware that if Fredericia receives materials and samples with insufficient information, delivery times will be affected.

Address:
Fredericia Furniture A/S
Treldevej 183
Gate 2
DK-7000 Fredericia

Table size seating overview













MODEL	PRODUCT	SIZE (CM)	TABLE HEIGHTS AVAILABLE	SEATS (PATO)
6624	Plan Table	70 x 60	Dining, counter and bar height	
6627	Plan Table	Ø72	Dining, counter and bar height	
6629	Plan Table	Ø90	Dining, counter and bar height	
6622 6625	Plan Table Plan Table	Ø120 Ø150		 
6630	Plan Table Fixed	160 x 90	Dining, counter and bar height	
6631 6632	Plan Table Fixed & Extendable	200 x 100 200/260 x 100	Dining*, counter and bar height * Extendable table is only available in dining height	
6633	Plan Table Extendable	200/260 x 100	Dining height	
6645	Plan Table Fixed	Ø150	Dining, counter and bar height	
667B	Plan Table, Configuration B	120 x 260	Dining, counter and bar height	
667D	Plan Table, Configuration D	120 x 320	Dining, counter and bar height	
667F	Plan Table, Configuration F	120 x 380	Dining, counter and bar height	
667H	Plan Table, Configuration H	120 x 440	Dining, counter and bar height	

Table size seating overview

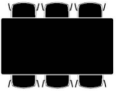
MODEL	PRODUCT	SIZE (CM)		SEATS (J39)
6280 6282	Mogensen BM80 Shaker Table	90 x 90 Ø120		
6292	Mogensen C18 Table	160 x 80	Shaker-style frame allows for any chair width	
6290	Mogensen C18 Table	180 x 90	Shaker-style frame allows for any chair width	
6293	Mogensen C18 Table	220 x 90	Shaker-style frame allows for any chair width	
6284	Mogensen 6284 Table	180 x 90		
6286	Mogensen 6286 Table	195 x 97,5	Shaker-style frame allows for any chair width	
6386	Mogensen 6386 Table	245 x 97,5	Shaker-style frame allows for any chair width	
6438	Post Table	225 x 100		
6441	Post Table	270 x 100		
6442	Post Table	320 x 100		

Terms and conditions of sale and delivery for Fredericia Furniture A/S

Sale and claim process

Our Customer Care team is ready to assist you with the ordering and claim process.

Offer

You can request an offer by sending an e-mail to our Customer Care team at the following e-mail address: quote@fredericia.com

Any offer is made subject to errors, omissions and other inconsistencies, including misspellings. The stated dates of delivery are indicative only, as Fredericia reserves the right to change the dates of delivery in the final order confirmation.

Offers are binding for Fredericia for 60 days from the date of the offer, unless the price list is updated with new prices within 60 days from the date of the offer, or unless another deadline is expressly stated in the offer.

How to place an order

You can place an order by emailing our Customer Care team via the following email address: salesorder@fredericia.com

Please make sure your order is correct and includes all the information needed to process it, such as quantity/size/colour/legs/glders etc. Please also use the correct product name as stated in our pricelist.

Receiving the order confirmation

You will receive the order confirmation as soon as the order has been entered into our system. You can usually expect to receive this confirmation within 48 hours from sending the order.

Please always check the order confirmation as soon as possible after receiving it and contact us immediately if you find any discrepancies. It is the customer's responsibility to review the order confirmation upon receipt.

Changes or cancellations of orders

In general, we advise to keep cancellations to a minimum, but if changes or cancellations are needed, following rules apply.

- Changes to orders later than three working days after receipt of the order confirmation may affect both delivery and price, and a surcharge of EUR 40 / DKK 300 / SEK 420 / NOK 445 / GBP 41 will be charged.
- If an order is canceled later than three days after the order confirmation, a fee of at least 10 % of the order amount will be charged. In addition, if customer-specific materials have been ordered and confirmed, an amount corresponding to the cost of this will be charged.

Returns

Returns are generally not accepted.

If you wish to return products, this can only be done with prior written agreement with Fredericia.

Terms of delivery

Please find the expected week of dispatch in your order confirmation.

If your order is delayed for various reasons, we will inform you of the new expected delivery week whenever possible.

If the delay exceeds 3 months and is not due to force majeure, you have the right to cancel the order. If a confirmed shipment is postponed at the customer's request, Fredericia reserves the right to invoice the total order amount on the originally agreed shipment date.

Fredericia cannot be held responsible for delivery issues or delays due to force majeure.

If delivery is postponed by the customer for more than 7 days, we reserve the right to charge a storage fee for the subsequent period until delivery takes place.

Requests for non-standard fabric 'Graded-in, COM and COL'

Graded-in fabric

We offer a large selection of fabrics and leathers in our standard fabric program which are listed in the pricelist. These have been carefully selected by the Fredericia design team.

In addition, we offer a wider range of graded-in fabrics for upholstery. If graded-in fabrics are requested, we will inform you whether a specific fabric is suitable for the requested design and cost. Please contact our Customer Care.

COM fabrics and COL leather

Fredericia offers upholstery in customer-specific fabric and leather (COM and COL), after approval by Fredericia quality department. For textiles and leather that do not appear in Fredericia's standard or Graded-in program, we require a sample of at least 30 x 30 cm for testing, to determine whether the fabric is suitable for the design.

To proceed with COM fabric or leather, please send your request to our Customer Care team via customerservice@fredericia.com

Materials sent to Fredericia are delivered as "DDP - delivered duty paid". Fredericia reserves the right to change the delivery time and charge a fee if the material is not delivered as described above. Please note that customs and other expenses in connection with sending material samples are for the customer's own account.

Product range

Fredericia has the right to cease production of certain products without notice.

Dimensions and tolerances

The stated dimensions are indicative and may vary, and deviations from a product's stated dimensions may occur. Any colour or wood samples must be considered indicative. Fredericia cannot be held responsible for any differences between samples and the delivered products, and small variations in colours or wood materials may occur in large orders, as the products change naturally over time. Such variations are not considered manufacturing defects.

Reservation of ownership

Fredericia reserves, with the limitations resulting from inalienable legal rules, ownership of the sold item until the entire purchase price plus accrued costs has been paid to Fredericia.

Claims

We are dedicated to processing your claim efficiently, and we strive to respond as soon as possible. We kindly ask you to register your claim as soon as you find a defect in your product.

Please send your claim to service@fredericia.com including information as, pictures, item description, order number, dimensions, defect description, pictures of any visible stamps on the product etc. It is possible to fill in a claim form via below link, to secure all necessary information included in the inquiry.

<https://fredericia.com/da-DK/professionals#/gallery/Claims>

If the claim is accepted, Customer Care places an order for a new product or remedy the defect, by ordering a spare part or securing a repair.

Replacement orders or spare parts are only delivered to the same

delivery address as the original order. Costs in connection with delivery or installation at the end customer are not covered by Fredericia. Cost for delivering a replacement or sparepart to the original address is covered by Fredericia. We will inform you whether you should return the defective product.

Product liability

Fredericia is liable if a delivered product causes personal injury or causes damage to property, if the object in question is, by its nature, usually intended for commercial use and is mainly used by the injured party accordingly.

Fredericia is not responsible for damage to commercial property, unless it is documented that the damage is due to errors on Fredericia's part that should not have been prevented by the Buyer's examination of the delivered products.

If a third party makes a claim for compensation for product liability against the Buyer, the Buyer must immediately notify Fredericia in writing.

Limitation of liability

Fredericia's liability is in all respects limited to the following.

Fredericia assumes no liability for losses caused by delay, defects or other non-compliance, unless the loss is caused by gross negligence on Fredericia's part.

Fredericia assumes no responsibility for indirect losses, including loss of goodwill, lost profits (e.g. loss of profit), operating losses, running costs or loss of clientele.

Fredericia's liability for damages in relation to a single order is in all cases limited to the value of the order in question calculated as the total purchase price excluding VAT.

- COM – customer leather, customer fabrics or material ordered separately.
- In cases of consequential or incidental damage.
- If the product has been stored, assembled, or maintained wrongly.
- In the attempt of a failed repair or modification of the product without Fredericia's consent.
- If the product has been abused, misused, or cleaned using wrong cleaning methods.
- Damage due to normal wear and tear
- If products intended for indoor use have been placed outdoors or in a humid environment.
- If products intended for indoor use have been exposed to prolonged strong sunlight or heat.
- If a product deviates from a sample of wood or fabric. As the material matures naturally over a period, samples can only be considered as a guiding.
- Cane wicker is excepted from the extended warranty, and a two-year warranty is provided.

Products manufactured according to customer specifications are not covered by Fredericia's test certificates regarding strength, durability and stability, and Fredericia therefore gives no warranty in this regard.

The original purchase invoice is mandatory when a claim is made under the extended warranty.

Replaced products or replaced product parts shall become the property of Fredericia. Delivery of a replacement product or repair of a product does not result in a renewal or extension of the applicable warranty period.

Any inquiries or questions related to this warranty should be directed to our Customer Care department.

Warranty

Extended product warranty

Fredericia offers an extended warranty against production and construction defects. The warranty covers faults which were present at the time of purchase, or which have arisen due to faults which were present at the time of purchase. The warranty period is calculated from the date of the original invoice. During the applicable warranty period, Fredericia will, at its sole obligation and its sole discretion, either repair, replace or issue a credit note regarding the defective product, the defective part or the defective components.

Extended product warranty applies from products purchased after 1st of January 2023.

25-year warranty

A 25-year warranty is provided on selected models:

- The Spanish Chair (2226)
- OX og Queen Chair (1000/1010)
- Corona Chair (5000)
- BM 22 collection by Børge Mogensen

10-year warranty

A 10-year warranty is provided on sofas.

7-year warranty

A 7-year warranty is provided on armchairs, chairs, tables, coffee tables and smaller pieces of furniture under our Complements collection (e.g. side tables) for furniture for indoor use.

2-year warranty

A 2-year warranty is provided on lamps and accessories, including vases and loose spare parts including furniture for outdoor use.

The warranty does not apply in the following situations (the list is non-exhaustive):

Transport

Standard delivery

Delivery of goods from Fredericia is deemed to have occurred when the customer has received the goods. Standard delivery will be made to the same country as the invoicing address. All orders are shipped with the best suitable carrier and week of dispatch is indicated on your order confirmation. The stated delivery date is indicative and may therefore be waived. Standard delivery addresses cannot be located in a country different from the country of the invoicing address.

Non-standard delivery address

For orders above a high minimum order value, we are able to deliver to a non-standard delivery address. If a non-standard delivery address is requested, your Customer Care representative will send you a form to be filled out with details. Any changes to the sales order or delivery booking cannot be made before the form has been returned.

Any request for delivery to a non-standard delivery address, may be charged with a special delivery surcharge calculated on a case by case basis.

Any special requirements on delivery, ex. use of lorry with a tail lift etc. may be charged with a special delivery surcharge calculated on a case by case basis.

Please check the delivery surcharges with our Customer Care.

Change of delivery address

- Changes to delivery address can be made up until two weeks before confirmed dispatch week, however changes will be charged a fee of EUR 40 / DKK 300 / SEK 420 / NOK 445 / GBP 41.
- Changes to delivery address less than two weeks before confirmed dispatch week, will be charged a fee of EUR 100 / DKK 750 / SEK 1.050 / NOK 1.100 / GBP 103.
- Changes to delivery address after the order has left our warehouse, an extra fee will be added depending on the status of the delivery.

Please contact your Customer Care representative in all cases.

Fix delivery / delivery of low amount orders

Please inform your Customer Care representative if you need a fixed date or time for your order, so that we can include this in your order confirmation.

Fixed delivery on a specific date, will be charged an extra fee of EUR 100 EUR / DKK 750 / SEK 1.050 / NOK 1.100 / GBP 103

Fixed delivery on a specific timeslot, will be charged an extra fee of EUR 100 EUR / DKK 750 / SEK 1.050 / NOK 1.100 / GBP 103
We reserve the right to change confirmed date and time of delivery due to force majeure.

For the delivery of smaller orders with a value below EUR 700 / DKK 5,200 / SEK 7.750 / NOK 8.000 / GBP 712 a separate shipping surcharge of EUR 60 / DKK 450 / SEK 870 / NOK 900 / GBP 62 will be applied.

For the delivery of spare parts unrelated to a claim with a value below EUR 700 / DKK 5,200 / SEK 7.750 / NOK 8.000 / GBP 712 a separate shipping surcharge of EUR 20 / DKK 75 / SEK 225 / NOK 250 / GBP 10 will be applied.

An inaccessibility surcharge may apply in densely built-up areas (minimum DKK 350).

For deliveries to private addresses, an additional delivery fee will be charged.

Standard delivery conditions

Standard delivery conditions to addresses located within Europe is either "DAP – Delivered At Place" or "DDP – Delivered Duty Paid", unless stated otherwise on your order.

Standard delivery conditions to addresses located outside Europe is "EXW – Ex Works", unless stated otherwise on your order.

For specific information about your delivery conditions, please see your order confirmation or contact our Customer Care.

Transport damages and missing products

Upon delivery, it is your responsibility to check the delivery for visible damages. If the delivery does not comply with your expectations, reservations should be made on the delivery note and expressly noted to the carrier immediately on the CMR document. The note must include a clear and detailed description of whether the products are damaged, wet etc. For documentation purposes, please make sure to take pictures of the damaged pallets, packaging or products right after delivery and forward them according to our claim procedure.

Missing products should be noted on the delivery note and CMR document. Please contact our Customer Care immediately after delivery and confirmation of missing products. We will investigate the missing delivery in our supply chain and logistics. If no proper documentation and pictures is provided and the claim is not received within 72 hours of receipt of the goods, Fredericia is not obligated to accept the claim.

Non-visible damage

If there are no visible damages to the exterior of the packaging or the products upon receipt, but visible damages to the products are discovered after the opening of the packaging, it must be reported to us in writing. You are required to take photographs of the product and the packaging and submit them to us along with a written report as soon as they are discovered, and no later than 7 days after receipt.

Payment

Any questions to making payments, our accounting department is always at your service to assist. Our accounting department can be contacted on economy@fredericia.com.

Payment information

All payments must be made using bank transfer to Fredericia's account at the Buyer's expense, unless another payment method is agreed in writing. The payment information for bank transfers, such as the IBAN number and SWIFT code, can be found on your sales order or -invoice.

For sales invoices:

- Please refer to the invoice number in the payment description. It is possible to combine payments for several invoices in one transfer. All invoices paid must be referenced in the payment description.

For sales orders (prepayment / payment-before-production):

- Please refer to the sales order number (SO123456) in the payment description. If missing payment description with proper referencing, Fredericia reserve the right to change the confirmed date and time of delivery on your expense.

Debtor policy

New customers at Fredericia are obliged to make a prepayment on the first three orders. Please note that the prepayment must happen before initiating the production of the submitted order. Credit assessment may be requested for subsequent orders. For customers with a credit limit, this can be disclosed by the sales- or customer service representative. If the credit limit for an account is reached, Fredericia requires previous invoices to be paid in full before new orders can be placed.

Invoices and prepayments of sales orders must be paid on time. If a due date is exceeded, payment reminders will be sent followed by debt collection and temporary closure of the account.

Fredericia has the right to impose interest of 2.0% per month started from the day after the due date and until full payment has been made. Fees for payment reminders are charged in accordance with applicable law.

Failure to make timely payment for an order will be considered a material breach. In the event of non-payment, Fredericia has the right to withhold all further deliveries to the customer. Fredericia assumes no responsibility as a result of withholding deliveries, regardless of whether such deliveries are interconnected.

Payment to Fredericia cannot be withheld on the basis that the product is defective, unless Fredericia has acknowledged the claim.

Reminders

- First reminder: five (5) days after due date
- Second reminder: ten (10) days after the first reminder was sent.
- Third reminder: ten (10) days after second reminder was sent. On third reminder, we inform you that your account has been suspended for further orders and will also include notification of debt collection.

Account suspension and reactivating account

For accounts that has been suspended, Fredericia will not process or deliver orders (confirmed/not confirmed) until the overdue amount has been paid.

Once the overdue amount has been paid, the account suspension will be revoked and confirmed orders will be processed and shipped as indicated on your order.

For accounts that has been suspended and reactivated, the general payment terms will be revoked, and the following three order must again be prepaid according to the debtor policy. Fredericia will decide if the general payment terms can be changed depending on your payment history.

Bank account information

Fredericia can receive payments using the following currency accounts depending on invoice/order currency. If payment is made to a below account that differs from its main currency, Fredericia reserve the right to add surcharges depending on the bank fees.

Always use the bank information provided on your sales invoice or -order.

CURRENCY	IBAN	SWIFT/BIC
DKK	DK8920000440300510	NDEADKKK
EUR	DK0320005005892335	NDEADKKK
NOK	NO7460210722087	NDEANOKK
SEK	SE3695000099601819659515	NDEASESS

CONTACT

Fredericia Furniture A/S
Treldevej 183
7000 Fredericia
customerservice@fredericia.com
www.fredericia.com

Chairs & Stools

Model 3261

BM61 Chair Cane wicker



Designed by Børge Mogensen, 1958

Chair in solid wood with seat and back in cane webbing. Mounted with interchangeable plastic glides. Separate felt glides included.

Modeldetails

0,25 m³ Packaging dimensions:
6 kg / 4,3 kg L: 55 cm W: 55 cm H: 83 cm

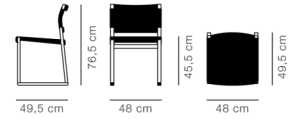

Essential Assortment

Pre-configured

Item number	Wood	Seat and back	Price
32611054000	Oak oil	Cane wicker, natural	2.720

Order configuration

	Oak oiled	Oak lacquered
Natural cane wicker	2.720	2.720

Frame in Oak lacquered, available while stocks last.

Model 3361



BM61 Chair Linen webbing

Designed by Børge Mogensen, 1958

Chair in solid wood. Seat and back in linen webbing. Mounted with interchangeable plastic glides. Separate felt glides included.

Modeldetails

0,25 m³ Packaging dimensions:
5,4 kg / 4,4 kg L: 55 cm W: 55 cm H: 83 cm

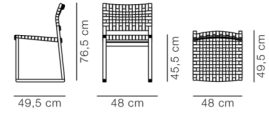

Essential Assortment

Pre-configured

Item number	Wood	Seat and back	Price
33610063100	Oak black lacquered	Linen webbing black	1.270
33611053000	Oak oil	Linen webbing natural	1.270

Order configuration

	Oak black lacquered	Oak oiled	Oak lacquered
Natural webbing	1.270	1.270	1.270
Black webbing	1.270		

Frame in Oak lacquered, available while stocks last.

Certifications

EN 1022:2005, EN 16139:2013 (L2)

Model 3262

BM62 Armchair Cane wicker



Designed by Børge Mogensen, 1958

Armchair in solid wood with seat and back in cane webbing. Mounted with interchangeable plastic glides. Separate felt glides included.

Modeldetails

0,32 m³ Packaging dimensions:
7,3 kg / L: 55 cm W: 67 cm H: 83 cm
5,1 kg

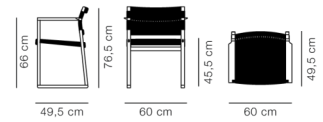

Essential Assortment

Pre-configured

Item number	Wood	Seat and back	Price
32621054000	Oak oil	Cane wicker, natural	3.190

Order configuration

	Oak oiled	Oak lacquered
Natural cane wicker	3.190	3.190

Frame in Oak lacquered, available while stocks last.

Model 3362

BM62 Armchair Linen webbing



Designed by Børge Mogensen, 1958

Chair in solid wood. Seat and back in linen webbing. Mounted with interchangeable plastic glides. Separate felt glides included.

Modeldetails

0,3 m³ Packaging dimensions:
6,2 kg / 5,2 kg L: 55 cm W: 67 cm H: 83 cm

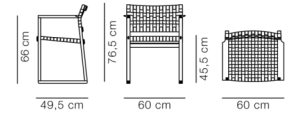

Essential Assortment

Pre-configured

Item number	Wood	Seat and back	Price
33620063100	Oak black lacquered	Linen webbing black	1.470
33621053000	Oak oil	Linen webbing natural	1.470

Order configuration

	Oak black lacquered	Oak oiled	Oak lacquered
Natural webbing	1.470	1.470	1.470
Black webbing	1.470		

Frame in Oak lacquered, available while stocks last.

Certifications

EN 1022:2005, EN 16139:2013 (L2)

Model 4810

Eyes 4 Leg Chair Tube base



Designed by Foersom & Hiort-Lorenzen, 2007

Chair with shell in moulded cold cured foam in HR or CMHR foam, reinforced with steel, fully upholstered in fabric or leather. Base of steel tube mounted with plastic glides. Felt glides available.

Modeldetails

0,47 m³ Packaging dimensions:
13 kg / 10 kg L: 66 cm W: 74 cm H: 96 cm

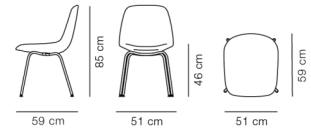

Essential Assortment

Pre-configured

Item number	Upholstery	Frame	Price
4810193000006000503	Re-Wool 198	Black	795
48101931100006000503	Re-Wool 128	Black	795
48104452400006000603	Gentle 873	Brushed stainless steel	1.240

Essential variants are delivered with plastic glides and HR foam

Order configuration

	Black	Brushed stainless steel
Fabric group 0	740	740
Fabric group 1	795	795
Fabric group 2	880	880
Fabric group 3	915	915
Fabric group 4	1.035	1.035
Fabric group 5	1.240	1.240
C.O.M. fabric	795	795
Leather group 0	1.195	1.195
Leather group 1	1.285	1.285
Leather group 2	1.430	1.430
Leather group 3	1.660	1.660
Leather group 4	1.775	1.775
Leather group 5	2.040	2.040
C.O.M. leather	1.285	1.285

Fabric consumption: 1,2 m. Leather consumption: 2,5 m²

As standard delivered without decoration buttons.

Available while stocks last.

Extra charge for

Buttons in the same upholstery as the chair or in selected leather: +103

Certifications

EN 1022:2005, EN 16139:2013 (L2)

Recommended upholstery

Fabric group 0	Connect
Fabric group 1	Remix, Bardal, Re-wool, Capture, Linara, Natural Linen, Erik
Fabric group 2	Hallingdal, Barnum, Fiord, Steelcut Trio, Loop, Ruskin
Fabric group 3	Sunniva, Vidar, Divina Melange, Clay
Fabric group 4	Safire, Sisu, Elle, Cotil
Fabric group 5	Gentle
Leather group 0	Vice
Leather group 1	Omni
Leather group 2	Primo, Trace
Leather group 3	Max
Leather group 4	Vegeta, Organic, Nubuck

Model 4830

Eyes 4 Leg Barstool



Designed by Foersom & Hiort-Lorenzen, 2007

Barstool with shell in moulded cold cured foam in HR or CMHR foam, reinforced with steel, fully upholstered in fabric or leather. Base of steel tube mounted with plastic glides. Felt glides available. Available in bar height.

Modeldetails

0,55 m³ Packaging dimensions:
15 kg / 12 kg L: 65 cm W: 66 cm H: 129 cm

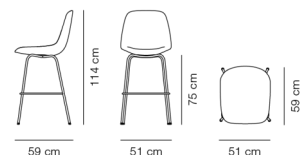

Essential Assortment

Pre-configured

Item number	Upholstery	Frame	Price
4830193000006000523	Re-Wool 198	Black, 75 cm	1.130
48301931100006000523	Re-Wool 128	Black, 75 cm	1.130
48304452400006000623	Gentle 873	Brushed stainless steel, 75 cm	1.640

Essential variants are delivered with plastic glides and HR foam

Order configuration

Barheight.

	Black	Brushed stainless steel
Fabric group 0	1.050	1.050
Fabric group 1	1.130	1.130
Fabric group 2	1.210	1.210
Fabric group 3	1.250	1.250
Fabric group 4	1.365	1.365
Fabric group 5	1.640	1.640
C.O.M. fabric	1.130	1.130
Leather group 0	1.505	1.505
Leather group 1	1.620	1.620
Leather group 2	1.770	1.770
Leather group 3	2.000	2.000
Leather group 4	2.115	2.115
Leather group 5	2.435	2.435
C.O.M. leather	1.620	1.620

Fabric consumption: 1,2 m. Leather consumption: 2,5 m²

As standard delivered without decoration buttons.

Counter height (seat height 65 cm) in brushed stainless steel available upon request.

Available while stocks last.

Extra charge for

Buttons in the same upholstery as the chair or in selected leather: +103

Certifications

EN 1022:2005, EN 16139:2013 (L1)

Recommended upholstery

Fabric group 0	Connect
Fabric group 1	Capture, Bardal, Linara, Remix, Re-wool, Natural Linen, Erik
Fabric group 2	Hallingdal, Steelcut Trio, Fiord, Ruskin, Barnum, Loop
Fabric group 3	Sunniva, Divina Melange, Clay, Vidar
Fabric group 4	Safire, Sisu, Elle, Cotil
Fabric group 5	Gentle
Leather group 0	Vice
Leather group 1	Omni
Leather group 2	Primo, Trace
Leather group 3	Max
Leather group 4	Vegeta, Organic, Nubuck

Model 4808

Eyes Cantilever Armchair



Designed by Foersom & Hiort-Lorenzen, 2007

Chair with shell in moulded cold cured foam in HR or CMHR foam, reinforced with steel, fully upholstered in fabric or leather. Cantilever base in steel with leather armrests. Mounted with plastic glides.

Modeldetails

0,47 m³ Packaging dimensions:
13 kg / L: 66 cm W: 74 cm H: 96 cm
10 kg

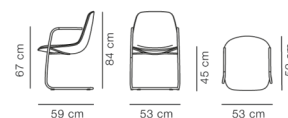

Essential Assortment

Pre-configured

Item number	Upholstery	Frame	Price
4808193000006000550	Re-Wool 198	Black, arm with leather 98, black	1.275
48081931100006000550	Re-Wool 128	Black, arm with leather 98, black	1.275
48084452400006000640	Gentle 873	Mat chrome, arm leather 95 cognac	1.870

Essential variants are delivered with plastic glides and HR foam

Order configuration

Arm: Leather (90 natural, 95 cognac or 98 black).

	Black	Mat chrome
Fabric group 0	1.185	1.185
Fabric group 1	1.275	1.275
Fabric group 2	1.370	1.370
Fabric group 3	1.420	1.420
Fabric group 4	1.560	1.560
Fabric group 5	1.870	1.870
C.O.M. fabric	1.275	1.275
Leather group 0	1.730	1.730
Leather group 1	1.860	1.860
Leather group 2	2.040	2.040
Leather group 3	2.315	2.315
Leather group 4	2.455	2.455
Leather group 5	2.820	2.820
C.O.M. leather	1.860	1.860

Fabric consumption: 1,2 m. Leather consumption: 2,5 m²

As standard delivered without decoration buttons.

Available while stocks last.

Extra charge for

Buttons in the same upholstery as the chair or in selected leather: +103

Recommended upholstery

Fabric group 0	Connect
Fabric group 1	Remix, Bardal, Re-wool, Capture, Linara, Natural Linen, Erik
Fabric group 2	Hallingdal, Barnum, Fiord, Steelcut Trio, Loop, Ruskin
Fabric group 3	Sunniva, Vidar, Divina Melange, Clay
Fabric group 4	Safire, Sisu, Elle, Cotil
Fabric group 5	Gentle
Leather group 0	Vice
Leather group 1	Omni
Leather group 2	Primo, Trace
Leather group 3	Max
Leather group 4	Vegeta, Organic, Nubuck

Model 4818

Eyes Swivel Chair Swivel base



Designed by Foersom & Hiort-Lorenzen, 2007

Chair with shell in moulded cold cured foam in HR or CMHR foam, reinforced with steel, fully upholstered in fabric or leather. 4-point swivel base in aluminum. Mounted with plastic glides. Felt glides and castors available. The base is not height adjustable.

Modeldetails

0,47 m³ Packaging dimensions:
16 kg / L: 66 cm W: 74 cm H: 96 cm
13 kg



Order configuration

	Black	Polished aluminium
Fabric group 0	1.035	1.035
Fabric group 1	1.115	1.115
Fabric group 2	1.200	1.200
Fabric group 3	1.240	1.240
Fabric group 4	1.365	1.365
Fabric group 5	1.640	1.640
C.O.M. fabric	1.115	1.115
Leather group 0	1.515	1.515
Leather group 1	1.630	1.630
Leather group 2	1.790	1.790
Leather group 3	2.035	2.035
Leather group 4	2.155	2.155
Leather group 5	2.480	2.480
C.O.M. leather	1.630	1.630

Fabric consumption: 1,2 m. Leather consumption: 2,5 m²

As standard delivered without decoration buttons.

Available while stocks last.

Extra charge for

Buttons in the same upholstery as the chair or in selected leather: +103
Castors: +24

Certifications

EN 1022:2005, EN 16139:2013 (L1)

Recommended upholstery

Fabric group 0	Connect
Fabric group 1	Remix, Bardal, Linara, Re-wool, Capture, Natural Linen, Erik
Fabric group 2	Steelcut Trio, Ruskin, Barnum, Fiord, Hallingdal, Loop
Fabric group 3	Sunniva, Clay, Vidar, Divina Melange
Fabric group 4	Sisu, Safire, Elle, Cotil
Fabric group 5	Gentle
Leather group 0	Vice
Leather group 1	Omni
Leather group 2	Primo, Trace
Leather group 3	Max
Leather group 4	Vegeta, Organic, Nubuck

Model 4820

Eyes Swivel Armchair Swivel base



Designed by Foersom & Hiort-Lorenzen, 2007

Chair with shell in moulded cold cured foam in HR or CMHR foam, reinforced with steel, fully upholstered in fabric or leather. Armrests in stainless steel and leather. 4-point swivel base in aluminum. Mounted with reversible plastic glides which can be changed to felt when reversed. Castors available. The base is not height adjustable.

Modeldetails

0,47 m³ Packaging dimensions:
17 kg / 14 kg L: 66 cm W: 74 cm H: 96 cm

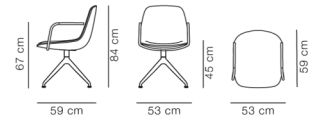

Order configuration

Arm: **Leather (90 natural, 95 cognac or 98 black).**

	Black	Polished aluminium
Fabric group 0	1.300	1.300
Fabric group 1	1.395	1.395
Fabric group 2	1.485	1.485
Fabric group 3	1.525	1.525
Fabric group 4	1.650	1.650
Fabric group 5	1.980	1.980
C.O.M. fabric	1.395	1.395
Leather group 0	1.780	1.780
Leather group 1	1.915	1.915
Leather group 2	2.075	2.075
Leather group 3	2.320	2.320
Leather group 4	2.440	2.440
Leather group 5	2.805	2.805
C.O.M. leather	1.915	1.915

Fabric consumption: 1,2 m. Leather consumption: 2,5 m²
As standard delivered without decoration buttons.

Available while stocks last.

Extra charge for

Buttons in the same upholstery as the chair or in selected leather: +103
Castors: +24

Certifications

EN 1022:2005, EN 16139:2013 (L1)

Recommended upholstery

Fabric group 0	Connect
Fabric group 1	Remix, Bardal, Linara, Re-wool, Capture, Natural Linen, Erik
Fabric group 2	Steelcut Trio, Ruskin, Barnum, Fiord, Hallingdal, Loop
Fabric group 3	Sunniva, Clay, Vidar, Divina Melange
Fabric group 4	Sisu, Safire, Elle, Cotil
Fabric group 5	Gentle
Leather group 0	Vice
Leather group 1	Omni
Leather group 2	Primo, Trace
Leather group 3	Max
Leather group 4	Vegeta, Organic, Nubuck

Model 3381

Flamingo Chair Swivel base



Designed by Foersom & Hiort-Lorenzen, 2003

Swivel chair with shell in moulded cold cured foam, either HR or CMHR foam, reinforced with steel, fully upholstered in fabric or leather. Cover is non-removable. Swivel base of stainless steel tube, mounted with plastic glides. Felt glides are available.

Modeldetails

0,47 m³ Packaging dimensions:
18 kg / 15 kg L: 66 cm W: 74 cm H: 96 cm



Essential Assortment

Pre-configured

Item number	Upholstery	Frame	Price
338100219060140	Hallingdal 130	Brushed stainless steel	1.860
338150093060140	Leather Max 93, Indian red	Brushed stainless steel	3.055
338150095060140	Leather Max 95, Cognac	Brushed stainless steel	3.055
338150098060140	Leather Max 98, Black	Brushed stainless steel	3.055

Essential variants are delivered with plastic glides and HR foam

Order configuration

	Black	Brushed stainless steel
Fabric group 1	1.740	1.740
Fabric group 2	1.860	1.860
Fabric group 3	1.915	1.915
Fabric group 4	2.080	2.080
Fabric group 5	2.495	2.495
C.O.M. fabric	1.740	1.740
Leather group 0	2.270	2.270
Leather group 1	2.445	2.445
Leather group 2	2.680	2.680
Leather group 3	3.055	3.055
Leather group 4	3.240	3.240
Leather group 5	3.725	3.725
C.O.M. leather	2.445	2.445

Fabric consumption: 1,5 m. Leather consumption: 2,5 m²

Extra charge for

Glides with felt: +24

Certifications

EN 1022:2005, EN 16139:2013 (L1)

Recommended upholstery

Fabric group 1	Remix, Capture, Bardal, Re-wool
Fabric group 2	Loop, Steelcut Trio, Fiord, Ruskin, Hallingdal, Barnum
Fabric group 3	Vidar, Clay, Divina Melange
Fabric group 4	Elle, Sisu, Safire
Fabric group 5	Gentle
Leather group 0	Vice
Leather group 1	Omni
Leather group 2	Primo, Trace
Leather group 3	Max
Leather group 4	Nubuck, Vegeta, Organic

Model 5810

Gomo Armchair Tube base



Designed by Hugo Passos, 2025

Fully upholstered chair with a core of moulded recycled polypropylene. The seat has a core of plywood. Covered in removable HR or CMHR foam and upholstered in removable textile or leather cover fixed with Velcro. Steel tube base in brushed stainless steel or powder coat. Metal screws and fittings. Mounted with interchangeable plastic glides. Felt glides are available.

Modeldetails

0,32 m³ Packaging dimensions:
13,5 kg / L: 64 cm W: 61 cm H: 83 cm
10 kg

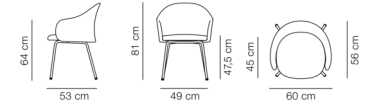

Essential Assortment

Pre-configured

Item number	Upholstery	Frame	Price
58104494800000501101	Blazer CUZ4D Dunalk	Black	660
58104495100000601101	Blazer CUZ47 Fairfield	Brushed stainless steel	730
58104494500000501101	Myr 362	Black	845
58104494600000491101	Mylla 221	Flint	845
58104494700000601101	Mylla 811	Brushed stainless steel	920

Essential variants are delivered with plastic glides and HR foam

Order configuration

	Black / Flint	Brushed stainless steel
Fabric group 0	620	690
Fabric group 1	660	730
Fabric group 2	745	820
Fabric group 3	845	920
Fabric group 4	940	1.010
Fabric group 5	1.155	1.225
C.O.M. fabric	660	730
Leather group 0	935	1.005
Leather group 1	1.050	1.120
Leather group 2	1.230	1.300
Leather group 3	1.385	1.450
Leather group 4	1.665	1.730
Leather group 5	2.145	2.215
C.O.M. leather	1.050	1.120

Fabric consumption: 1,5 m. Leather consumption: 3,4 m²

Certifications

FSC® certified

EN 1022:2005, EN 16139:2013 (L2), ANSI/BIFMA X7.1/M7.1 VOC test (tested with HR foam and EU Ecolabel fabric)

Recommended upholstery

Fabric group 0	Connect
Fabric group 1	Remix, Capture, Bardal, Re-wool, Erik
Fabric group 2	Hallingdal, Loop, Steelcut Trio, Steelcut Quartet, Fiord, Ruskin, Savoy
Fabric group 3	Tonus, Divina Melange, Zero, Vidar, Sunniva, Clay
Fabric group 4	Elle, Sisu, Safire
Leather group 0	Vice
Leather group 1	Omni
Leather group 2	Primo, Trace
Leather group 3	Max
Leather group 4	Nubuck, Vegeta, Cera, Organic

Model 5812

Gomo Armchair Wood base



Designed by Hugo Passos, 2025

Fully upholstered chair with a core of moulded recycled polypropylene. The seat has a core of plywood.

Covered in removable HR or CMHR foam and upholstered in removable textile or leather cover fixed with Velcro. Solid wooden base. Metal screws and fittings. Available with plastic or felt glides.

Modeldetails

0,32 m³ Packaging dimensions:
13,5 kg / 10 kg L: 64 cm W: 61 cm H: 83 cm

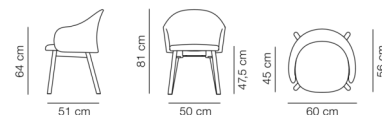

Essential Assortment

Pre-configured

Item number	Upholstery	Frame	Price
5812449480000853000	Blazer CUZ4D Dunalk	Oak black lacquer, FSC Mix 70%	795
5812449510000854000	Blazer CUZ47 Fairfield	Oak lacquer, FSC Mix 70%	795
5812449450000853000	Myr 362	Oak black lacquer, FSC Mix 70%	980
5812449460000855000	Mylla 221	Smoked oak stained lacquer, FSC Mix 70%	980
5812449470000854000	Mylla 811	Oak lacquer, FSC Mix 70%	980

Essential variants only delivered with HR foam

Order configuration

Frame: Oak lacquered, oak black lacquered or smoked oak stained, lacquered.

Fabric group 0	750
Fabric group 1	795
Fabric group 2	880
Fabric group 3	980
Fabric group 4	1.070
Fabric group 5	1.290
C.O.M. fabric	795
Leather group 0	1.065
Leather group 1	1.180
Leather group 2	1.360
Leather group 3	1.530
Leather group 4	1.830
Leather group 5	2.335
C.O.M. leather	1.180

Fabric consumption: 1,5 m. Leather consumption: 3,4 m²

Certifications

FSC® certified

EN 1022:2005, EN 16139:2013 (L1), ANSI/BIFMA X7.1/M7.1 VOC test - frames oak lacquered, oak black lacquered (tested with HR foam and EU Ecolabel fabric)

Recommended upholstery

Fabric group 0	Connect
Fabric group 1	Remix, Capture, Bardal, Re-wool, Erik
Fabric group 2	Hallingdal, Loop, Steelcut Trio, Steelcut Quartet, Fiord, Ruskin, Savoy
Fabric group 3	Tonus, Divina Melange, Zero, Vidar, Sunniva, Clay
Fabric group 4	Elle, Sisu, Safire
Leather group 0	Vice
Leather group 1	Omni
Leather group 2	Primo, Trace
Leather group 3	Max
Leather group 4	Nubuck, Vegeta, Organic

Model 5811

Gomo Armchair Swivel base 4-star



Designed by Hugo Passos, 2025

Fully upholstered chair with a core of moulded recycled polypropylene. The seat has a core of plywood. Covered in removable HR or CMHR foam. Upholstered in removable textile or leather cover fixed with Velcro. 4-star swivel base in casted aluminium mounted with interchangeable plastic or felt glides. Swivel base and castors in either polished or powder coated aluminium. Metal screws and fittings. Castors, return function or tilt available at upcharge.

Modeldetails

0,32 m³ Packaging dimensions:
16 kg / L: 64 cm W: 61 cm H: 83 cm
12,5 kg



Essential Assortment

Pre-configured

Item number	Upholstery	Frame	Price
58114494800000501101	Blazer CUZ4D Dunalk	Black	700
58114495100000401101	Blazer CUZ47 Fairfield	Polished aluminium	700
58114494500000501101	Myr 362	Black	875
58114494600000491101	Mylla 221	Flint	875
58114494700000401101	Mylla 811	Polished aluminium	875

Essential variants are delivered with plastic glides and HR foam

Order configuration

Frame: Polished aluminium, black or flint.

Fabric group 0	665
Fabric group 1	700
Fabric group 2	785
Fabric group 3	875
Fabric group 4	975
Fabric group 5	1.185
C.O.M. fabric	700
Leather group 0	965
Leather group 1	1.085
Leather group 2	1.260
Leather group 3	1.415
Leather group 4	1.695
Leather group 5	2.180
C.O.M. leather	1.085

Fabric consumption: 1,5 m. Leather consumption: 3,4 m²

Extra charge for

Tilt:	+40
Wheels:	+40
Return function base:	+40

Certifications

FSC® certified

EN 1022:2005, EN 16139:2013 (L1), ANSI/BIFMA X7.1/M7.1 VOC test (tested with HR foam and EU Ecolabel fabric)

Recommended upholstery

Fabric group 0	Connect
Fabric group 1	Remix, Capture, Bardal, Re-wool, Erik
Fabric group 2	Hallingdal, Loop, Steelcut Trio, Steelcut Quartet, Fiord, Ruskin, Savoy
Fabric group 3	Tonus, Divina Melange, Zero, Vidar, Sunniva, Clay
Fabric group 4	Elle, Sisu, Safire
Leather group 0	Vice
Leather group 1	Omni
Leather group 2	Primo, Trace
Leather group 3	Max
Leather group 4	Nubuck, Vegeta, Organic

Model 5813

Gomo Armchair Swivel base 5-star



Designed by Hugo Passos, 2025

Fully upholstered chair with a core of moulded recycled polypropylene. The seat has a core of plywood.

Covered in removable HR or CMHR foam and upholstered in removable textile or leather cover fixed with Velcro. 5-star swivel base with gas lift in casted aluminium mounted with castors. Swivel base and castors in polished or powder coated aluminium. Metal screws and fittings. Tilt available at upcharge.

Modeldetails

0,32 m³ Packaging dimensions:
16,5 kg / 13 kg L: 64 cm W: 61 cm H: 83 cm

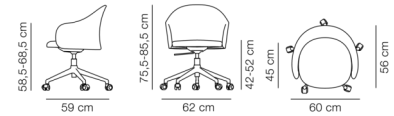

Essential Assortment

Pre-configured

Item number	Upholstery	Frame	Price
58134494800000502501	Blazer CUZ4D Dunalk	Black	795
58134495100000402501	Blazer CUZ47 Fairfield	Polished aluminium	795
58134494500000502501	Myr 362	Black	980
58134494600000492501	Mylla 221	Flint	980
58134494700000402501	Mylla 811	Polished aluminium	980

Essential variants are delivered with castors and HR foam

Order configuration

Frame: Polished aluminium, black or flint.

Fabric group 0	750
Fabric group 1	795
Fabric group 2	880
Fabric group 3	980
Fabric group 4	1.070
Fabric group 5	1.290
C.O.M. fabric	795
Leather group 0	1.065
Leather group 1	1.180
Leather group 2	1.360
Leather group 3	1.530
Leather group 4	1.830
Leather group 5	2.335
C.O.M. leather	1.180

Fabric consumption: 1,5 m. Leather consumption: 3,4 m²

Extra charge for

Tilt: +40

Certifications

FSC® certified

EN 1022:2005, EN 16139:2013 (L1), ANSI/BIFMA X7.1/M7.1 VOC test (tested with HR foam and EU Ecolabel fabric)

Recommended upholstery

Fabric group 0	Connect
Fabric group 1	Remix, Capture, Bardal, Re-wool, Erik
Fabric group 2	Hallingdal, Loop, Steelcut Trio, Steelcut Quartet, Fiord, Ruskin, Savoy
Fabric group 3	Tonus, Divina Melange, Zero, Vidar, Sunniva, Clay
Fabric group 4	Elle, Sisu, Safire
Leather group 0	Vice
Leather group 1	Omni
Leather group 2	Primo, Trace
Leather group 3	Max
Leather group 4	Nubuck, Vegeta, Organic

Model P5811

Gomo Armchair Accessories Loose cover

Designed by Hugo Passos, 2025

Loose cover for re-upholstery of Gomo Armchair. Professional assistance is recommended.

Order configuration

Fabric group 0	220
Fabric group 1	260
Fabric group 2	295
Fabric group 3	340
Fabric group 4	380
Fabric group 5	515
C.O.M. fabric	260
Leather group 0	330
Leather group 1	435
Leather group 2	535
Leather group 3	685
Leather group 4	900
Leather group 5	1.130
C.O.M. leather	435

Fabric consumption: 1,5 m. Leather consumption: 3,4 m²

Recommended upholstery

Fabric group 0	Connect
Fabric group 1	Remix, Capture, Bardal, Re-wool, Erik
Fabric group 2	Hallingdal, Loop, Steelcut Trio, Steelcut Quartet, Fiord, Ruskin, Savoy
Fabric group 3	Tonus, Divina Melange, Zero, Vidar, Sunniva, Clay
Fabric group 4	Elle, Sisu, Safire
Leather group 0	Vice
Leather group 1	Omni
Leather group 2	Primo, Trace
Leather group 3	Max
Leather group 4	Nubuck, Vegeta, Organic

Model 3239

J39 Mogensen Chair Paper cord



Designed by Børge Mogensen, 1947

Chair in solid wood with woven paper cord seat. Molded veneer back with core in the same wood as top veneer.

Modeldetails

0,3 m³ Packaging dimensions:
6,2 kg / 4,8 kg L: 53 cm W: 55 cm H: 101 cm

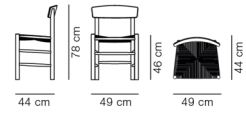

Essential Assortment

Pre-configured

Item number	Seat	Wood	Price
32392172510	Natural paper cord	Beech black lacquer, FSC Mix 70%	460
32392202510	Natural paper cord	Beech vintage lacquer, FSC Mix 70%	460
32392802510	Natural paper cord	Beech khaki green, FSC Mix 70%	460
32392812510	Natural paper cord	Beech indigo blue, FSC Mix 70%	460
32392822510	Natural paper cord	Beech Heritage red, FSC Mix 70%	460
32392832510	Natural paper cord	Beech pebble grey, FSC Mix 70%	460
32392032510	Natural paper cord	Oak soap, FSC Mix 70%	705
32392052510	Natural paper cord	Oak oil, FSC Mix 70%	705
32392062510	Natural paper cord	Oak light oil, FSC Mix 70%	705
32392242610	Black paper cord	Oak black lacquer, FSC Mix 70%	755

Order configuration

	Oak black lacquered	Beech coloured lacquer	Beech soap	Oak soap	Oak oiled	Oak light oil	Walnut oiled
Seat natural paper cord	705	460	460	705	705	705	850
Seat black paper cord	755						

Beech coloured lacquer: Black, White, Indigo blue, Khaki green, Heritage red, Pebble grey, Vintage lacquered.

Price per unit.
Sold in packs of 2pcs in same colour.

Extra charge for

QuickClick glides with or without felt (R3239): +24

Certifications

Oak is FSC® certified
Beech is FSC® certified
Oak and Beech are Nordic Swan Ecolabel
ANSI/BIFMA X5.4-2020

Model P3239



J39 Mogensen Chair Seat pad

Designed by Fredericia Furniture, 2022

Seat cushion for J39 Mogensen chair. HR Foam with cover in black semi-aniline or Russet brown (cognac) aniline leather and backing in canvas. Produced from excess and scrap leather from own production in Denmark.

Modeldetails

0,14 m³ Packaging dimensions:
10 kg / L: 53 cm W: 52 cm H: 50 cm
7,2 kg



Order configuration

	Leather Cera Russet brown Unit price	Leather Cera Russet brown Total	Leather Primo Black Unit price	Leather Primo Black Total
1 pcs	135	135	135	135
12 pcs	129	1.540	129	1.540
24 pcs	123	2.935	123	2.935

Recommended upholstery

Leather group 2 Primo
Leather group 4 Cera

Model 3339

J39 Mogensen Chair Seat upholstered



Designed by Børge Mogensen, 1969

Chair in solid wood mounted with structural webbing and a removable canvas or leather cover done with zippers and a thin layer of polyester padding. Molded veneer back with core in the same wood as top veneer.

Modeldetails

0,3 m³ Packaging dimensions:
5,2 kg / 3,8 kg L: 53 cm W: 55 cm H: 101 cm

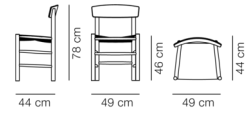

Essential Assortment

Pre-configured

Item number	Upholstery	Wood	Price
3339217499990000	Black canvas	Beech black lacquer, FSC Mix 70%	460
3339220499980000	Natural canvas	Beech vintage lacquer, FSC Mix 70%	460
3339217513010000	Leather Omni 301, Black	Beech black lacquer, FSC Mix 70%	480
3339205499990000	Black canvas	Oak oil, FSC Mix 70%	705
3339206499980000	Natural canvas	Oak light oil, FSC Mix 70%	705
3339205513070000	Leather Omni 307, Cognac	Oak oil, FSC Mix 70%	745
3339164513770000	Leather Omni 377, Dark brown	Walnut oiled	885

Order configuration

Selected leathers: Omni in black 301, cognac 307 or dark brown 377.

Hallingdal: All Colours

	Oak black lacquered	Beech coloured lacquer	Beech soap	Oak soap	Oak oiled	Oak light oil	Walnut oiled
Canvas black or natural	705	460	460	705	705	705	850
Selected leathers	745	480	480	745	745	745	885
Hallingdal	740	490	490	740	740	740	890

Fabric consumption: 0,54 m. Leather consumption: 0,47 m²

Beech coloured lacquer: Black, White, Indigo blue, Khaki green, Heritage red, Pebble grey, Vintage lacquered.

Other fabrics or leathers on request at MOQ 50 pcs.

Extra charge for

QuickClick glides with or without felt (R3239): +24

Certifications

Oak is FSC® certified

Beech is FSC® certified

EN 1022:2005, EN 16139:2013 (L1)

Recommended upholstery

Fabric group 2 Hallingdal
Leather group 1 Omni

Model
P3339

J39 Accessories

Cover for J39 Seat upholstered

Designed by Børge Mogensen

Loose cover for the J39 Mogensen chair with seat upholstery. Please note all chairs must be pre-mounted with structural webbing before mounting the loose cover.

Order configuration

Selected leathers: Omni in black 301, cognac 307 or dark brown 377.

Hallingdal: All Colours

Canvas black or natural	205
Selected leathers	235
Hallingdal	245

Fabric consumption: 0,54 m. Leather consumption: 0,47 m²

Recommended upholstery

Fabric group 2 Hallingdal
Leather group 1 Omni

Model 3207



Klint Chair

Designed by Kaare Klint, 1936

Chair with solid wood frame and a woven paper cord seat. Molded veneer back with core in the same wood as top veneer.

Modeldetails

0,52 m³ Packaging dimensions:
6,5 kg / 4,5 kg L: 58 cm W: 51 cm H: 89 cm

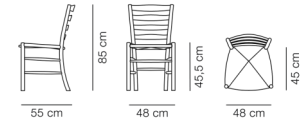

Essential Assortment

Pre-configured

Item number	Seat	Wood	Price
32072242500	Natural paper cord	Oak black lacquer, FSC Mix 70%	720
32072032500	Natural paper cord	Oak soap, FSC Mix 70%	960
32072052500	Natural paper cord	Oak oil, FSC Mix 70%	960

Extra charge for

QuickClick glides with or without felt (R3207G): +24

Certifications

FSC® certified
Nordic Swan Ecolabel
EN 1022:2005, EN 16139:2013 (L1)

Model 3208



Klint Armchair

Designed by Kaare Klint, 1936

Armchair with solid wood frame and a woven paper cord seat. Molded veneer back with core in the same wood as top veneer.

Modeldetails

0,3 m³ Packaging dimensions:
8 kg / 5,5 kg L: 57 cm W: 61 cm H: 87 cm

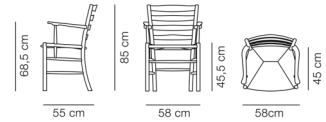

Essential Assortment

Pre-configured

Item number	Seat	Wood	Price
32082242500	Natural paper cord	Oak black lacquer, FSC Mix 70%	840
32082032500	Natural paper cord	Oak soap, FSC Mix 70%	1.085
32082052500	Natural paper cord	Oak oil, FSC Mix 70%	1.085

Extra charge for

QuickClick glides with or without felt (R3207G): +24

Certifications

FSC® certified
Nordic Swan Ecolabel
EN 1022:2005, EN 16139:2013 (L1)

Model 3080

Lynderup Chair Wooden seat



Designed by Børge Mogensen, 1954

Stacking chair with steel tube frame. Interchangeable back and seat of plywood finished with water-based lacquer. Frame of powder coated or chromed tubular steel. Mounted with interchangeable plastic glides. Separate felt glides included.

Modeldetails

0,4 m³ Packaging dimensions:
6,5 kg / 5,5 kg L: 60 cm W: 71 cm H: 96 cm

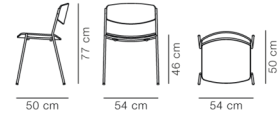

Essential Assortment

Pre-configured

Item number	Wood	Frame	Price
30802021791075001	Oak lacquer, FSC Mix 70%	Black lacquer	485
30802231791075001	Black ash, FSC Mix 70%	Black lacquer	485
30802261791075001	Walnut lacquer, FSC Mix 70%	Black lacquer	485

Order configuration

	Oak lacquered	Black ash	Walnut lacquered
Black	485	485	485
Chrome	485	485	485

Stackable: 20 pcs. on trolley, 12 pcs. on floor.

Certifications

EU Ecolabel
FSC® certified
EN 1022:2005, EN 16139:2013 (L1)

Model 3081

Lynderup Chair Seat upholstered



Designed by Børge Mogensen, 1954

Stacking chair with steel tube frame and upholstered seat. Interchangeable back finished with water-based lacquer. Plywood has beech core with ash, oak or walnut top veneer. Interchangeable seat pad upholstered in HR or CMHR foam with fixed cover in fabric or leather. Frame of powder coated or chromed tubular steel. Mounted with interchangeable plastic glides. Separate felt glides included.

Modeldetails

0,41 m³ Packaging dimensions:
7,5 kg / 6,5 kg L: 60 cm W: 71 cm H: 96 cm

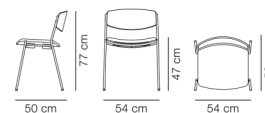

Essential Assortment

Pre-configured

Item number	Upholstery	Wood	Frame	Price
30810130102021791075	Connect 60147	Oak lacquer, FSC Mix 70%	Black lacquer	620
30810130302231791075	Connect 60999	Black ash, FSC Mix 70%	Black lacquer	620
30810130302261791075	Connect 60999	Walnut lacquer, FSC Mix 70%	Black lacquer	620
30811930002231791075	Re-Wool 198	Black ash, FSC Mix 70%	Black lacquer	635
30811930002261791075	Re-Wool 198	Walnut lacquer, FSC Mix 70%	Black lacquer	635
30811931102021791075	Re-Wool 128	Oak lacquer, FSC Mix 70%	Black lacquer	635
30815130102021791075	Leather Omni 301, Black	Oak lacquer, FSC Mix 70%	Black lacquer	650
30815130102231791075	Leather Omni 301, Black	Black ash, FSC Mix 70%	Black lacquer	650
30815130102261791075	Leather Omni 301, Black	Walnut lacquer, FSC Mix 70%	Black lacquer	650

Essential variants only delivered with HR foam

Order configuration

Frame: Chrome or black.

	Oak lacquered	Black ash	Walnut lacquered
Fabric group 0	620	620	620
Fabric group 1	635	635	635
Fabric group 2	670	670	670
Fabric group 3	700	700	700
Fabric group 4	755	755	755
Fabric group 5	830	830	830
C.O.M. fabric	635	635	635
Leather group 0	630	630	630
Leather group 1	650	650	650
Leather group 2	685	685	685
Leather group 3	695	695	695
Leather group 4	725	725	725
Leather group 5	835	835	835
C.O.M. leather	650	650	650

Fabric consumption: 0,6 m. Leather consumption: 0,54 m²

Stackable: 15 pcs. on trolley, 8 pcs. on floor.

Certifications

EU Ecolabel variants: Chrome or black powder-coated frame together with black shell, HR foam and upholstery in Omni leather 301 black or Connect, Remix, Re-wool fabric

FSC® certified

EN 1022:2005, EN 16139:2013 (L1)

Recommended upholstery

Fabric group 0	Connect
Fabric group 1	Remix, Capture, Bardal, Re-wool, Linara, Natural Linen, Erik, Gran Linen
Fabric group 2	Loop, Steelcut Trio, Fiord, Ruskin, Savoy, Hallingdal, Barnum
Fabric group 3	Vidar, Sunniva, Clay, Divina Melange, SheWorks Ribbon
Fabric group 4	Sisu, Safire, Elle, Cotil
Fabric group 5	Grand Mohair, Gentle
Leather group 0	Vice
Leather group 1	Omni
Leather group 2	Primo, Trace
Leather group 3	Max
Leather group 4	Nubuck, Vegeta, Organic, Cera

**Model
3078**

Lynderup Accessories Coupling device



Designed by Fredericia Furniture

Black coupling device in plastic for Lynderup Chair. The device is interchangeable and can be added to a standard chair. When not in use, it can be flipped under the seat and remain on the chair until next use and when stacking the chair.

Order configuration

For model 3080
and 3081

15

**Model
3079**

Lynderup Accessories Chair suspensions

Designed by Fredericia Furniture

Chair suspensions in black powder coated steel. Can only be used on tables without an apron at the edge. Only one template is needed for mounting all chair suspensions.

Order configuration

	No template	Template enclosed
Black	70	165

Model 1004

Pato / Lynderup Accessories Transport trolley



Designed by Fredericia Furniture

Transport trolley for the stackable chairs Lynderup, Pato Sledge and Pato 4-Leg.
Black powder coated steel.

Modeldetails

0,77 m³ Packaging dimensions:
24 kg / 18 kg L: 90 cm W: 59 cm H: 102 cm

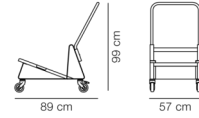

Order configuration

Black	1.060
-------	-------

Model 3236

Mogensen 3236 Chair

Seat upholstered



Designed by Børge Mogensen, 1956

Frame of solid wood and molded veneer back with core in the same wood as top veneer. Plywood core seat upholstered with HR or CMHR foam and covered in fabric or leather.

Modeldetails

0,28 m³ Packaging dimensions:
7,5 kg / 6 kg L: 50 cm W: 54 cm H: 83 cm

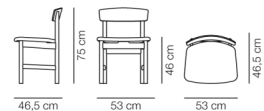

Essential Assortment

Pre-configured

Item number	Upholstery	Wood	Price
323620351301	Leather Omni 301, Black	Oak soap, FSC Mix 70%	925
323622451301	Leather Omni 301, Black	Oak black lacquer, FSC Mix 70%	925

Essential variants only delivered with HR foam

Order configuration

	Oak black lacquered	Oak soap	Oak oiled	Oak light oil
Fabric group 1	915	915	915	915
Fabric group 2	960	960	960	960
Fabric group 3	1.015	1.015	1.015	1.015
Fabric group 4	1.090	1.090	1.090	1.090
Fabric group 5	1.145	1.145	1.145	1.145
C.O.M. fabric	915	915	915	915
Leather group 0	860	860	860	860
Leather group 1	925	925	925	925
Leather group 2	990	990	990	990
Leather group 3	1.080	1.080	1.080	1.080
Leather group 4	1.190	1.190	1.190	1.190
Leather group 5	1.355	1.355	1.355	1.355
C.O.M. leather	925	925	925	925

Fabric consumption: 0,6 m. Leather consumption: 0,67 m²

Extra charge for

QuickClick glides with or without felt (R3236): +24

Certifications

FSC® certified
EN 1022:2023, EN 16139:2025 (L2)

Recommended upholstery

Fabric group 1	Gran Linen, Capture, Bardal, Re-wool, Natural Linen, Linara, Erik, Remix
Fabric group 2	Hallingdal, Barnum, Loop, Fiord, Steelcut Trio, Ruskin, Savoy
Fabric group 3	Divina Melange, Sunniva, Clay, Vidar
Fabric group 4	Cotil, Sisu, Elle, Safire
Fabric group 5	Grand Mohair, Gentle
Leather group 0	Vice
Leather group 1	Omni
Leather group 2	Primo, Trace
Leather group 3	Max
Leather group 4	Vegeta, Nubuck, Organic, Cera

Model 3171

The Mogensen Bench With back



Designed by Børge Mogensen, 1956

Frame of solid wood. Back is made from a single piece of solid wood. Seat of plywood core generously upholstered with HR or CMHR foam and covered in fabric or leather.

Modeldetails

0,82 m³ Packaging dimensions:
23 kg / 21 kg L: 175 cm W: 59 cm H: 79 cm

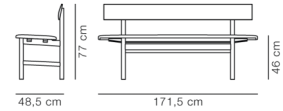

Essential Assortment

Pre-configured

Item number	Upholstery	Wood	Price
317100651301	Leather Omni 301, Black	Oak black lacquered	3.230
317110551301	Leather Omni 301, Black	Oak oil	3.230
317110951301	Leather Omni 301, Black	Smoked oak, oiled	3.410
317110750095	Leather Max 95, Cognac	Oak light oil	3.665
317110350090	Leather Vegeta 90, Natural	Oak soap	3.960

Essential variants only delivered with HR foam

Order configuration

	Oak soap	Oak oiled	Oak light oil	Oak black lacquered	Smoked oak, oiled
Fabric group 1	3.160	3.160	3.160	3.160	3.340
Fabric group 2	3.260	3.260	3.260	3.260	3.440
Fabric group 3	3.360	3.360	3.360	3.360	3.535
Fabric group 4	3.505	3.505	3.505	3.505	3.685
Fabric group 5	3.855	3.855	3.855	3.855	4.035
C.O.M. fabric	3.160	3.160	3.160	3.160	3.340
Leather group 0	2.985	2.985	2.985	2.985	3.160
Leather group 1	3.230	3.230	3.230	3.230	3.410
Leather group 2	3.410	3.410	3.410	3.410	3.590
Leather group 3	3.665	3.665	3.665	3.665	3.840
Leather group 4	3.960	3.960	3.960	3.960	4.135
Leather group 5	4.420	4.420	4.420	4.420	4.600
C.O.M. leather	3.230	3.230	3.230	3.230	3.410

Fabric consumption: 1,8 m. Leather consumption: 2,5 m²

Extra charge for

QuickClick glides with or without felt (R3171): +24

Recommended upholstery

Fabric group 1	Remix, Capture, Bardal, Re-wool, Linara, Erik, Natural Linen, Gran Linen
Fabric group 2	Hallingdal, Barnum, Loop, Steelcut Trio, Fiord, Ruskin, Savoy
Fabric group 3	Divina Melange, Vidar, Sunniva, Clay
Fabric group 4	Cotil, Elle, Sisu, Safire
Fabric group 5	Grand Mohair, Gentle
Leather group 0	Vice
Leather group 1	Omni
Leather group 2	Primo, Trace
Leather group 3	Max
Leather group 4	Nubuck, Vegeta, Cera, Organic

Model 3172

The Mogensen Bench Without back



Designed by Børge Mogensen, 1956 / 2025

Frame of solid wood. Seat of plywood core generously upholstered with HR or CMHR foam and covered in fabric or leather.

Modeldetails

0,37 m³ Packaging dimensions:
15 kg / 13 kg L: 174 cm W: 44 cm H: 48,5 cm

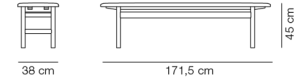

Order configuration

	Oak soap	Oak oiled	Oak light oil	Oak black lacquered	Smoked oak, oiled
Fabric group 1	2.390	2.390	2.390	2.390	2.520
Fabric group 2	2.475	2.475	2.475	2.475	2.605
Fabric group 3	2.555	2.555	2.555	2.555	2.685
Fabric group 4	2.675	2.675	2.675	2.675	2.805
Fabric group 5	2.965	2.965	2.965	2.965	3.095
C.O.M. fabric	2.390	2.390	2.390	2.390	2.520
Leather group 0	2.460	2.460	2.460	2.460	2.590
Leather group 1	2.570	2.570	2.570	2.570	2.700
Leather group 2	2.670	2.670	2.670	2.670	2.800
Leather group 3	2.830	2.830	2.830	2.830	2.960
Leather group 4	3.050	3.050	3.050	3.050	3.180
Leather group 5	3.430	3.430	3.430	3.430	3.560
C.O.M. leather	2.570	2.570	2.570	2.570	2.700

Fabric consumption: 1,8 m. Leather consumption: 2,5 m²

Extra charge for

QuickClick glides with or without felt (R3171): +24

Recommended upholstery

Fabric group 1	Remix, Capture, Bardal, Re-wool, Linara, Erik, Natural Linen, Gran Linen
Fabric group 2	Hallingdal, Barnum, Loop, Steelcut Trio, Fiord, Ruskin, Savoy
Fabric group 3	Divina Melange, Vidar, Sunniva, Clay
Fabric group 4	Cotil, Elle, Sisu, Safire
Fabric group 5	Grand Mohair, Gentle
Leather group 0	Vice
Leather group 1	Omni
Leather group 2	Primo, Trace
Leather group 3	Max
Leather group 4	Nubuck, Vegeta, Cera, Organic

Model 4200

Pato 4 Leg Chair Polypropylene seat



Designed by Welling / Ludvik, 2013

Stacking chair. Shell of 100% recycled coloured-through polypropylene. Frame of steel tube chromed or powder coated. Mounted with plastic glides.

Modeldetails

0,48 m³ Packaging dimensions:
6,6 kg / 5 kg L: 59 cm W: 63 cm H: 95 cm



Essential Assortment

Pre-configured

Item number	Shell	Frame	Price
42000740005	Quartz grey	Black	225
42001140005	White	Black	225
42001240005	Black	Black	225
42001540005	Ocean	Black	265
42001640005	Storm	Black	265
42001940005	Stone	Black	265
42002340005	Ancient green	Black	265
42002440005	Dark red	Black	265
42002540005	Dark grey	Black	265
42002740005	Sand	Black	265

Essential variants are delivered with plastic glides

Order configuration

	Black / White / Quartz grey Polypropylene	Other standard colours Polypropylene
Black	225	265
Chrome	225	270

Stackable: 25 pcs. on trolley, 18 pcs. on floor.

Extra charge for

Glides with felt: +12
Other standard frame colours: +30

Certifications

EU Ecolabel variant: Black powder-coated frame

EN 1021-1:2006 - Smouldering cigarette, EN 1021-2:2006 - Match flame equivalent, EN 1022:2005, EN 16139:2013 (L2)

Model 4202

Pato 4 Leg Chair Fully upholstered



Designed by Welling / Ludvik, 2013

Fully upholstered chair, stackable. Inner shell of 100% recycled polypropylene with HR or CMHR foam, covered in fabric or leather. Cover is non-removable. Frame of steel tube chromed or powder coated. Mounted with plastic glides.

Modeldetails

0,36 m³ Packaging dimensions:
6,6 kg / 5 kg L: 60 cm W: 61 cm H: 94 cm

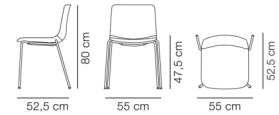

Essential Assortment

Pre-configured

Item number	Upholstery	Frame	Price
42020130340005	Connect 60999	Black	545
42020746540005	Remix 123	Black	570
42021930040005	Re-Wool 198	Black	570
42021931140005	Re-Wool 128	Black	570
42025130140005	Leather Omni 301, Black	Black	645
42025130740005	Leather Omni 307, Cognac	Black	645

Essential variants are delivered with plastic glides and HR foam

Order configuration

Frame: Chrome or black.

Fabric group 0	545
Fabric group 1	570
Fabric group 2	625
Fabric group 3	695
Fabric group 4	780
Fabric group 5	855
C.O.M. fabric	570
Leather group 0	600
Leather group 1	645
Leather group 2	760
Leather group 3	915
Leather group 4	1.005
Leather group 5	1.155
C.O.M. leather	645

Fabric consumption: 0,62 m. Leather consumption: 1,3 m²

Stackable: 15 pcs. on trolley, 10 pcs. on floor.

Extra charge for

Glides with felt:	+12
Other standard frame colours:	+30

Certifications

EU Ecolabel variants: Black powder-coated frame together with HR foam and upholstery in Omni leather 301 black or Connect, Remix, Re-wool fabric
EN 1022:2005, EN 16139:2013 (L2)

Recommended upholstery

Fabric group 0	Connect
Fabric group 1	Bardal, Capture, Remix, Linara, Re-wool, Natural Linen, Erik, Gran Linen
Fabric group 2	Barnum, Savoy, Steelcut Trio, Fiord, Hallingdal, Ruskin, Loop
Fabric group 3	Vidar, Clay, Sunniva, Divina Melange
Fabric group 4	Sisu, Elle, Safire, Cotil
Fabric group 5	Gentle, Grand Mohair
Leather group 0	Vice
Leather group 1	Omni
Leather group 2	Primo, Trace
Leather group 3	Max
Leather group 4	Nubuck, Organic, Cera, Vegeta

Model 4210

Pato 4 Leg Armchair Polypropylene seat



Designed by Welling / Ludvik, 2013

Stacking chair with armrests. Shell of 100% recycled coloured-through polypropylene. Arms of black powder coated aluminum. Frame of steel tube chromed or powder coated. Mounted with plastic glides.

Modeldetails

0,48 m³ Packaging dimensions:
6,6 kg / L: 59 cm W: 63 cm H: 89 cm
5,9 kg



Essential Assortment

Pre-configured

Item number	Shell	Frame	Price
4210121000513	Black	Chrome	410

Essential variants are delivered with plastic glides

Order configuration

	Standard colours Polypropylene
Black	410
Chrome	410

Stackable: 25 pcs. on trolley, 13 pcs. on floor.

Extra charge for

Glides with felt:	+12
Other standard frame colours:	+35

Certifications

EN 1021-1:2006 - Smouldering cigarette, EN 1021-2:2006 - Match flame equivalent, EN 1022:2005, EN 16139:2013 (L2)

Model 4212

Pato 4 Leg Armchair Fully upholstered



Designed by Welling / Ludvik, 2013

Fully upholstered chair with armrests, stackable. Inner shell of 100% recycled polypropylene with HR or CMHR foam, covered in fabric or leather. Cover is non-removable. Arms of black powder coated aluminum. Frame of steel tube chromed or powder coated. Mounted with plastic glides.

Modeldetails

0,36 m³ Packaging dimensions:
8,1 kg / 6,6 kg L: 59 cm W: 61 cm H: 94 cm

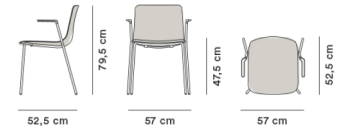

Essential Assortment

Pre-configured

Item number	Upholstery	Frame	Price
4212013034000513	Connect 60999	Black	680
4212074654000513	Remix 123	Black	710
4212193004000513	Re-Wool 198	Black	710
4212193114000513	Re-Wool 128	Black	710
4212513014000513	Leather Omni 301, Black	Black	790
4212513074000513	Leather Omni 307, Cognac	Black	790

Essential variants are delivered with plastic glides and HR foam

Order configuration

Frame: Chrome or black.

Fabric group 0	680
Fabric group 1	710
Fabric group 2	770
Fabric group 3	840
Fabric group 4	925
Fabric group 5	1.020
C.O.M. fabric	710
Leather group 0	735
Leather group 1	790
Leather group 2	905
Leather group 3	1.065
Leather group 4	1.170
Leather group 5	1.345
C.O.M. leather	790

Fabric consumption: 0,62 m. Leather consumption: 1,3 m²

Stackable: 15 pcs. on trolley, 10 pcs. on floor.

Extra charge for

Glides with felt:	+12
Other standard frame colours:	+35

Certifications

EN 1022:2005, EN 16139:2013 (L2)

Recommended upholstery

Fabric group 0	Connect
Fabric group 1	Gran Linen, Linara, Bardal, Capture, Remix, Re-wool, Natural Linen, Erik
Fabric group 2	Barnum, Savoy, Steelcut Trio, Fiord, Hallingdal, Loop, Ruskin
Fabric group 3	Clay, Sunniva, Divina Melange, Vidar
Fabric group 4	Sisu, Elle, Safire, Cotil
Fabric group 5	Gentle, Grand Mohair
Leather group 0	Vice
Leather group 1	Omni
Leather group 2	Primo, Trace
Leather group 3	Max
Leather group 4	Nubuck, Organic, Vegeta, Cera

Model 4100

Pato Sledge Chair Polypropylene seat



Designed by Welling / Ludvik, 2013

Stacking chair. Shell of 100% recycled coloured-through polypropylene. Frame of solid steel, chromed or powder coated. Mounted with plastic glides.

Modeldetails

0,36 m³ Packaging dimensions:
7,5 kg / 6,2 kg L: 58 cm W: 64 cm H: 95 cm



Essential Assortment

Pre-configured

Item number	Shell	Frame	Price
41000740040	Quartz grey	Black	225
41001140040	White	Black	225
41001240040	Black	Black	225
41001540040	Ocean	Black	265
41001640040	Storm	Black	265
41001940040	Stone	Black	265
41002340040	Ancient green	Black	265
41002440040	Dark red	Black	265
41002540040	Dark grey	Black	265
41002740040	Sand	Black	265

Essential variants are delivered with plastic glides

Order configuration

	Black / White / Quartz grey Polypropylene	Other standard colours Polypropylene
Black	225	265
Chrome	225	270

Stackable: 25 pcs. on trolley, 18 pcs. on floor.
Suitable for outdoor use when frame is powder coated.

Extra charge for

Glides with felt: +12
Other standard frame colours: +30

Certifications

EU Ecolabel variant: Black powder-coated frame
EN 1021-1:2006 - Smouldering cigarette, EN 1021-2:2006 - Match flame equivalent, EN 1022:2005, EN 16139:2013 (L1)

Model 4102

Pato Sledge Chair Fully upholstered



Designed by Welling / Ludvik, 2013

Fully upholstered chair, stackable. Inner shell of 100% recycled polypropylene with HR or CMHR foam, covered in fabric or leather. Cover is non-removable. Frame of solid steel, chromed or powder coated. Mounted with plastic glides.

Modeldetails

0,36 m³ Packaging dimensions:
8,5 kg / 7 kg L: 59 cm W: 61 cm H: 94 cm

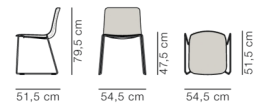

Essential Assortment

Pre-configured

Item number	Upholstery	Frame	Price
41020130340040	Connect 60999	Black	545
41020746540040	Remix 123	Black	570
41021930040040	Re-Wool 198	Black	570
41021931140040	Re-Wool 128	Black	570
41025130140040	Leather Omni 301, Black	Black	645
41025130740040	Leather Omni 307, Cognac	Black	645

Essential variants are delivered with plastic glides and HR foam

Order configuration

Frame: Chrome or black.

Fabric group 0	545
Fabric group 1	570
Fabric group 2	625
Fabric group 3	695
Fabric group 4	780
Fabric group 5	855
C.O.M. fabric	570
Leather group 0	600
Leather group 1	645
Leather group 2	760
Leather group 3	915
Leather group 4	1.005
Leather group 5	1.155
C.O.M. leather	645

Fabric consumption: 0,62 m. Leather consumption: 1,3 m²

Stackable: 15 pcs. on trolley, 10 pcs. on floor.

Extra charge for

Glides with felt:	+12
Other standard frame colours:	+30

Certifications

EU Ecolabel variants: Black powder-coated frame together with HR foam and upholstery in Omni leather 301 black or Connect, Remix, Re-wool fabric
EN 1022:2005, EN 16139:2013 (L1)

Recommended upholstery

Fabric group 0	Connect
Fabric group 1	Remix, Capture, Bardal, Linara, Re-wool, Natural Linen, Erik, Gran Linen
Fabric group 2	Barnum, Savoy, Steelcut Trio, Fiord, Hallingdal, Ruskin, Loop
Fabric group 3	Vidar, Clay, Sunniva, Divina Melange
Fabric group 4	Sisu, Elle, Safire, Cotil
Fabric group 5	Gentle, Grand Mohair
Leather group 0	Vice
Leather group 1	Omni
Leather group 2	Primo, Trace
Leather group 3	Max
Leather group 4	Nubuck, Cera, Organic, Vegeta

Model 4110

Pato Sledge Armchair Polypropylene seat



Designed by Welling / Ludvik, 2013

Stacking chair with armrests. Shell of 100% recycled coloured-through polypropylene. Frame of solid steel, chromed or powder coated. Mounted with plastic glides.

Modeldetails

0,36 m³ Packaging dimensions:
8,3 kg / 6,8 kg L: 59 cm W: 61 cm H: 94 cm



Essential Assortment

Pre-configured

Item number	Shell	Frame	Price
4110121004012	Black	Chrome	400

Essential variants are delivered with plastic glides

Order configuration

	Standard colours Polypropylene
Black	400
Chrome	400

Stackable: 25 pcs. on trolley, 13 pcs. on floor.

Extra charge for

Glides with felt:	+12
Other standard frame colours:	+35

Certifications

EN 1021-1:2006 - Smouldering cigarette, EN 1021-2:2006 - Match flame equivalent, EN 1022:2005, EN 16139:2013 (L1)

Model 4112

Pato Sledge Armchair Fully upholstered



Designed by Welling / Ludvik, 2013

Fully upholstered chair with armrests, stackable. Inner shell of 100% recycled polypropylene with HR or CMHR foam, covered in fabric or leather. Cover is non-removable. Frame of solid steel, chromed or powder coated. Mounted with plastic glides.

Modeldetails

0,36 m³ Packaging dimensions:
9,3 kg / L: 59 cm W: 61 cm H: 94 cm
7,8 kg

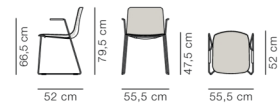

Essential Assortment

Pre-configured

Item number	Upholstery	Frame	Price
4112013034004012	Connect 60999	Black	675
4112074654004012	Remix 123	Black	710
4112193004004012	Re-Wool 198	Black	710
4112193114004012	Re-Wool 128	Black	710
4112513014004012	Leather Omni 301, Black	Black	785
4112513074004012	Leather Omni 307, Cognac	Black	785

Essential variants are delivered with plastic glides and HR foam

Order configuration

Frame: Chrome or black.

Fabric group 0	675
Fabric group 1	710
Fabric group 2	765
Fabric group 3	835
Fabric group 4	925
Fabric group 5	1.015
C.O.M. fabric	710
Leather group 0	730
Leather group 1	785
Leather group 2	905
Leather group 3	1.060
Leather group 4	1.170
Leather group 5	1.345
C.O.M. leather	785

Fabric consumption: 0,62 m. Leather consumption: 1,3 m²

Stackable: 15 pcs. on trolley, 10 pcs. on floor.

Extra charge for

Glides with felt:	+12
Other standard frame colours:	+35

Certifications

EN 1022:2005, EN 16139:2013 (L1)

Recommended upholstery

Fabric group 0	Connect
Fabric group 1	Remix, Natural Linen, Capture, Erik, Bardal, Linara, Gran Linen, Re-wool
Fabric group 2	Savoy, Steelcut Trio, Fiord, Loop, Barnum, Hallingdal, Ruskin
Fabric group 3	Sunniva, Divina Melange, Vidar, Clay
Fabric group 4	Elle, Safire, Sisu, Cotil
Fabric group 5	Gentle, Grand Mohair
Leather group 0	Vice
Leather group 1	Omni
Leather group 2	Primo, Trace
Leather group 3	Max
Leather group 4	Cera, Nubuck, Organic, Vegeta

Model 4300



Pato Sledge Barstool Polypropylene seat

Designed by Welling / Ludvik, 2013

Barstool. Shell of 100% recycled coloured-through polypropylene. Frame of solid steel, chromed or powder coated. Mounted with plastic glides. Please specify bar or counter height.

Modeldetails

0,34 m³ Packaging dimensions:
8 kg / 7,5 kg L: 57 cm W: 52 cm H: 115 cm

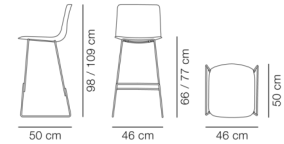

Essential Assortment

Pre-configured

Item number	Shell	Frame	Height	Price
4300124004077	Black	Black	Sh 77 cm	350

Essential variants are delivered with plastic glides

Order configuration

Bar or counter height.

	Standard colours Polypropylene	
Black	350	
Chrome	350	

Extra charge for

Glides with felt:	+12
Other standard frame colours:	+45

Certifications

EN 1021-1:2006 - Smouldering cigarette, EN 1021-2:2006 - Match flame equivalent, EN 1022:2005, EN 16139:2013 (L2)

Model 4302



Pato Sledge Barstool Fully upholstered

Designed by Welling / Ludvik, 2013

Fully upholstered barstool. Inner shell of 100% recycled polypropylene with HR or CMHR foam, covered in fabric or leather. Cover is non-removable. Frame of solid steel, chromed or powder coated. Mounted with plastic glides. Please specify bar or counter height.

Modeldetails

0,34 m³ Packaging dimensions:
9 kg / 8 kg L: 57 cm W: 53 cm H: 107 cm

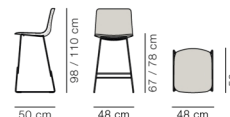

Essential Assortment

Pre-configured

Item number	Upholstery	Frame	Price
4302002194004077	Hallingdal 130	Black	725

Essential variants are delivered with plastic glides and HR foam

Order configuration

Frame: Chrome or black.
Bar or counter height.

Fabric group 0	635
Fabric group 1	665
Fabric group 2	725
Fabric group 3	790
Fabric group 4	880
Fabric group 5	970
C.O.M. fabric	665
Leather group 0	690
Leather group 1	745
Leather group 2	860
Leather group 3	1.020
Leather group 4	1.120
Leather group 5	1.290
C.O.M. leather	745

Fabric consumption: 0,62 m. Leather consumption: 1,3 m²

Extra charge for

Glides with felt:	+12
Other standard frame colours:	+45

Certifications

EN 1022:2005, EN 16139:2013 (L2)

Recommended upholstery

Fabric group 0	Connect
Fabric group 1	Gran Linen, Linara, Bardal, Capture, Remix, Re-wool, Natural Linen, Erik
Fabric group 2	Barnum, Savoy, Steelcut Trio, Fiord, Hallingdal, Ruskin, Loop
Fabric group 3	Vidar, Clay, Sunniva, Divina Melange
Fabric group 4	Sisu, Elle, Safire, Cotil
Fabric group 5	Gentle, Grand Mohair
Leather group 0	Vice
Leather group 1	Omni
Leather group 2	Primo, Trace
Leather group 3	Max
Leather group 4	Nubuck, Organic, Vegeta, Cera

Model 4312



Pato Sledge Stool Fully upholstered

Designed by Welling / Ludvik, 2016

Fully upholstered barstool, stackable. Inner shell of 100% recycled polypropylene with HR or CMHR foam, covered in fabric or leather. Cover is non-removable. Frame of solid steel, chromed or powder coated. Mounted with plastic glides. Please specify bar or counter height.

Modeldetails

0,32 m³ Packaging dimensions:
8,5 kg / 6,4 kg L: 52 cm W: 56 cm H: 113 cm

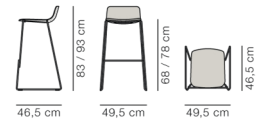

Essential Assortment

Pre-configured

Item number	Upholstery	Frame	Height	Price
43120130340040780	Connect 60999	Black	Sh 78 cm	625
43120746540040780	Remix 123	Black	Sh 78 cm	655
43121930040040780	Re-Wool 198	Black	Sh 78 cm	655
43121931140040780	Re-Wool 128	Black	Sh 78 cm	655
43125130140040780	Leather Omni 301, Black	Black	Sh 78 cm	730
43125130740040780	Leather Omni 307, Cognac	Black	Sh 78 cm	730

Essential variants are delivered with plastic glides and HR foam

Order configuration

Frame: Chrome or black.
Bar or counter height.

Fabric group 0	625
Fabric group 1	655
Fabric group 2	710
Fabric group 3	785
Fabric group 4	870
Fabric group 5	960
C.O.M. fabric	655
Leather group 0	680
Leather group 1	730
Leather group 2	855
Leather group 3	1.010
Leather group 4	1.115
Leather group 5	1.280
C.O.M. leather	730

Fabric consumption: 0,5 m. Leather consumption: 1,12 m²

Stackable: 12 pcs. on floor.

Extra charge for

Glides with felt:	+12
Other standard frame colours:	+45

Certifications

EN 1022:2005, EN 16139:2013 (L2)

Recommended upholstery

Fabric group 0	Connect
Fabric group 1	Gran Linen, Linara, Bardal, Capture, Remix, Re-wool, Natural Linen, Erik
Fabric group 2	Barnum, Savoy, Steelcut Trio, Fiord, Hallingdal, Ruskin, Loop
Fabric group 3	Vidar, Clay, Sunniva, Divina Melange
Fabric group 4	Sisu, Elle, Safire, Cotil
Fabric group 5	Gentle, Grand Mohair
Leather group 0	Vice
Leather group 1	Omni
Leather group 2	Primo, Trace
Leather group 3	Max
Leather group 4	Nubuck, Organic, Vegeta, Cera

Model 4002

Pato Swivel Chair Fully upholstered



Designed by Welling / Ludvik, 2014

Fully upholstered swivel chair. Inner shell of 100% recycled polypropylene with HR or CMHR foam, covered in fabric or leather. Cover is non-removable. 4-star aluminum base, polished or powder coated. Mounted with plastic glides.

Modeldetails

0,25 m³ Packaging dimensions:
12 kg / 8,9 kg L: 51 cm W: 56 cm H: 113 cm

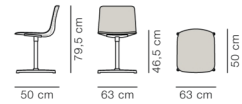

Essential Assortment

Pre-configured

Item number	Upholstery	Frame	Price
40020020140040	Hallingdal 180	Black	625

Essential variants are delivered with plastic glides and HR foam

Order configuration

Frame: Polished aluminium or black.

Fabric group 0	565
Fabric group 1	580
Fabric group 2	625
Fabric group 3	700
Fabric group 4	735
Fabric group 5	815
C.O.M. fabric	580
Leather group 0	690
Leather group 1	735
Leather group 2	780
Leather group 3	845
Leather group 4	945
Leather group 5	1.100
C.O.M. leather	735

Fabric consumption: 0,62 m. Leather consumption: 1,3 m²

Other frame colours by quotation (min. 25 pcs.).

Extra charge for

Glides with felt:	+12
Castors, chrome or black:	+24

Certifications

EN 1022:2005, EN 16139:2013 (L1)

Recommended upholstery

Fabric group 0	Connect
Fabric group 1	Gran Linen, Linara, Bardal, Capture, Remix, Natural Linen, Re-wool, Erik
Fabric group 2	Savoy, Barnum, Steelcut Trio, Fiord, Hallingdal, Ruskin, Loop
Fabric group 3	Vidar, Clay, Sunniva, Divina Melange
Fabric group 4	Sisu, Elle, Safire, Cotil
Fabric group 5	Gentle, Grand Mohair
Leather group 0	Vice
Leather group 1	Omni
Leather group 2	Primo, Trace
Leather group 3	Max
Leather group 4	Nubuck, Vegeta, Organic, Cera

Model 4012

Pato Swivel Armchair Fully upholstered



Designed by Welling / Ludvik, 2014

Fully upholstered swivel chair with armrests. Inner shell of 100% recycled polypropylene with HR or CMHR foam, covered in fabric or leather. Cover is non-removable. 4-star aluminum base, polished or powder coated. Mounted with plastic glides.

Modeldetails

0,48 m³ Packaging dimensions:
13 kg / L: 65 cm W: 72 cm H: 104 cm
10,6 kg

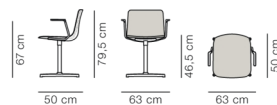

Essential Assortment

Pre-configured

Item number	Upholstery	Frame	Price
4012500904004013	Leather Vegeta 90, Natural	Black	1.075

Essential variants are delivered with plastic glides and HR foam

Order configuration

Frame: Polished aluminium or black.

Fabric group 0	690
Fabric group 1	710
Fabric group 2	755
Fabric group 3	830
Fabric group 4	865
Fabric group 5	950
C.O.M. fabric	710
Leather group 0	820
Leather group 1	865
Leather group 2	910
Leather group 3	980
Leather group 4	1.075
Leather group 5	1.235
C.O.M. leather	865

Fabric consumption: 0,62 m. Leather consumption: 1,3 m²

Other frame colours by quotation (min. 25 pcs.).

Extra charge for

Glides with felt:	+12
Castors, chrome or black:	+24

Recommended upholstery

Fabric group 0	Connect
Fabric group 1	Gran Linen, Linara, Capture, Remix, Natural Linen, Re-wool, Erik, Bardal
Fabric group 2	Savoy, Barnum, Steelcut Trio, Fiord, Hallingdal, Ruskin, Loop
Fabric group 3	Vidar, Clay, Sunniva, Divina Melange
Fabric group 4	Sisu, Elle, Safire, Cotil
Fabric group 5	Gentle, Grand Mohair
Leather group 0	Vice
Leather group 1	Omni
Leather group 2	Primo, Trace
Leather group 3	Max
Leather group 4	Nubuck, Vegeta, Organic, Cera

Model 4022

Pato Office Chair Fully upholstered



Designed by Welling / Ludvik, 2014

Fully upholstered height-adjustable swivel chair. Inner shell of 100% recycled polypropylene with HR or CMHR foam, covered in fabric or leather. Cover is non-removable. 5-star base with castors, aluminum polished or powder coated.

Modeldetails

0,42 m³ Packaging dimensions:
13 kg / 10,3 kg L: 69 cm W: 69 cm H: 88 cm

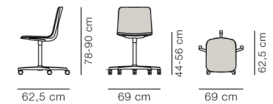

Essential Assortment

Pre-configured

Item number	Upholstery	Frame	Price
40220169240062	Loop 29	Black	685
40220549844261	Vidar 743	Polished aluminium	760

Essential variants are delivered with plastic glides and HR foam

Order configuration

Frame: Polished aluminum or black.

Fabric group 0	620
Fabric group 1	635
Fabric group 2	685
Fabric group 3	760
Fabric group 4	795
Fabric group 5	885
C.O.M. fabric	635
Leather group 0	755
Leather group 1	800
Leather group 2	845
Leather group 3	920
Leather group 4	1.020
Leather group 5	1.190
C.O.M. leather	800

Fabric consumption: 0,62 m. Leather consumption: 1,3 m²

Other frame colours by quotation (min. 25 pcs.).

Certifications

EN 1022:2005, EN 16139:2013 (L1)

Recommended upholstery

Fabric group 0	Connect
Fabric group 1	Gran Linen, Linara, Bardal, Capture, Remix, Re-wool, Natural Linen, Erik
Fabric group 2	Barnum, Savoy, Steelcut Trio, Fiord, Hallingdal, Ruskin, Loop
Fabric group 3	Vidar, Clay, Sunniva, Divina Melange
Fabric group 4	Sisu, Elle, Safire, Cotil
Fabric group 5	Gentle, Grand Mohair
Leather group 0	Vice
Leather group 1	Omni
Leather group 2	Primo, Trace
Leather group 3	Max
Leather group 4	Nubuck, Organic, Vegeta, Cera

Model 4032

Pato Office Armchair Fully upholstered



Designed by Welling / Ludvik, 2014

Fully upholstered height-adjustable swivel chair with armrests. Inner shell of 100% recycled polypropylene with HR or CMHR foam, covered in fabric or leather. Cover is non-removable. 5-star aluminum base with castors, polished or powder coated.

Modeldetails

0,42 m³ Packaging dimensions:
13 kg / L: 69 cm W: 69 cm H: 88 cm
10,3 kg

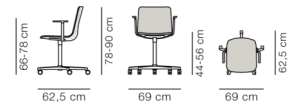

Essential Assortment

Pre-configured

Item number	Upholstery	Frame	Price
4032002014006213	Hallingdal 180	Black	800

Essential variants are delivered with plastic glides and HR foam

Order configuration

Frame: Polished aluminium or black.

Fabric group 0	735
Fabric group 1	755
Fabric group 2	800
Fabric group 3	875
Fabric group 4	915
Fabric group 5	1.000
C.O.M. fabric	755
Leather group 0	870
Leather group 1	920
Leather group 2	965
Leather group 3	1.040
Leather group 4	1.140
Leather group 5	1.310
C.O.M. leather	920

Fabric consumption: 0,62 m. Leather consumption: 1,3 m²

Other frame colours by quotation (min. 25 pcs.).

Certifications

EN 16139:2025 (L1), EN 1022:2023

Recommended upholstery

Fabric group 0	Connect
Fabric group 1	Linara, Capture, Remix, Natural Linen, Re-wool, Bardal, Gran Linen, Erik
Fabric group 2	Savoy, Barnum, Steelcut Trio, Fiord, Hallingdal, Ruskin, Loop
Fabric group 3	Clay, Sunniva, Divina Melange, Vidar
Fabric group 4	Sisu, Elle, Safire, Cotil
Fabric group 5	Gentle, Grand Mohair
Leather group 0	Vice
Leather group 1	Omni
Leather group 2	Primo, Trace
Leather group 3	Max
Leather group 4	Nubuck, Vegeta, Organic, Cera

Model 4072

Pato Executive Armchair

Height adjustable swivel base



Designed by Welling / Ludvik, 2015

Fully upholstered height-adjustable swivel chair with armrests. Inner shell of plywood with HR or CMHR foam, covered in fabric or leather. Cover is non-removable. 5-star base with castors, aluminum polished or powder coated. Please note chair cannot be delivered with glides instead of castors due to the gas lift.

Modeldetails

0,4 m³ Packaging dimensions:
14 kg / L: 64 cm W: 71 cm H: 104 cm
11,9 kg

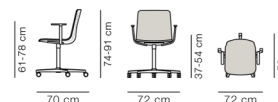

Essential Assortment

Pre-configured

Item number	Upholstery	Frame	Price
4072016714429612	Loop 33	Polished aluminium	980

Essential variants are delivered with plastic glides and HR foam

Order configuration

Frame: Polished aluminium or black.

Fabric group 0	890
Fabric group 1	920
Fabric group 2	980
Fabric group 3	1.075
Fabric group 4	1.135
Fabric group 5	1.275
C.O.M. fabric	920
Leather group 0	1.120
Leather group 1	1.215
Leather group 2	1.305
Leather group 3	1.445
Leather group 4	1.640
Leather group 5	1.980
C.O.M. leather	1.215

Fabric consumption: 0,9 m. Leather consumption: 2,3 m²

Other frame colours by quotation (min. 25 pcs.).

Certifications

FSC® certified

EN 1022:2005, EN 16139:2013 (L1)

Recommended upholstery

Fabric group 0	Connect
Fabric group 1	Natural Linen, Capture, Erik, Gran Linen, Linara, Bardal, Remix, Re-wool
Fabric group 2	Fiord, Barnum, Savoy, Steelcut Trio, Hallingdal, Ruskin, Loop
Fabric group 3	Vidar, Sunniva, Clay, Divina Melange
Fabric group 4	Elle, Cotil, Sisu, Safire
Fabric group 5	Gentle, Grand Mohair
Leather group 0	Vice
Leather group 1	Omni
Leather group 2	Primo, Trace
Leather group 3	Max
Leather group 4	Nubuck, Organic, Cera, Vegeta

Model 4203

Pato Paper 4 Leg Chair Papershell seat



Designed by Welling / Ludvik, 2025

Stacking chair. Shell made of Papershell cellulose composite, a material completely free of fossil carbon and 100% biogenic. Moulded in Sweden. Mounted on a steel tube base, chromed or powder coated, with visible black screws in the seat. Mounted with plastic glides.

Modeldetails

0,48 m³ Packaging dimensions:
6,6 kg / 5 kg L: 59 cm W: 63 cm H: 95 cm



Essential Assortment

Pre-configured

Item number	Shell	Frame	Price
42037740005	Papershell w/black screws, FSC Mix 70%	Black	365
42037710005	Papershell w/black screws, FSC Mix 70%	Chrome	365

Essential variants are delivered with plastic glides

Stackable: 25 pcs. on trolley, 18 pcs. on floor.

Extra charge for

Glides with felt:	+12
Other standard frame colours:	+30

Certifications

FSC® certified
EN 1022:2023, EN 16139:2025 (L2)

Model 4204

Pato Paper 4 Leg Chair Seat upholstered



Designed by Welling / Ludvik, 2025

Stacking chair with upholstered seat. Shell made of Papershell cellulose composite, a material completely free of fossil carbon and 100% biogenic. Moulded in Sweden. With a mounted plywood seat with HR or CMHR foam, covered in fabric or leather. Shell mounted on a steel tube base, chromed or powder coated. Mounted with plastic glides.

Modeldetails

0,48 m³ Packaging dimensions:
6,1 kg / 5,5 kg L: 58,5 cm W: 61 cm H: 94 cm



Order configuration

Frame: Chrome or black.

	Papershell
Fabric group 0	535
Fabric group 1	560
Fabric group 2	595
Fabric group 3	650
Fabric group 4	660
Fabric group 5	705
C.O.M. fabric	560
Leather group 0	575
Leather group 1	580
Leather group 2	650
Leather group 3	700
Leather group 4	725
C.O.M. leather	580

Fabric consumption: 0,5 m. Leather consumption: 0,4 m²

Stackable: 15 pcs. on trolley, 10 pcs. on floor.

Extra charge for

Glides with felt: +12
Other standard frame colours: +30

Certifications

FSC® certified
EN 1022:2023, EN 16139:2025 (L2)

Recommended upholstery

Fabric group 0	Connect
Fabric group 1	Erik, Gran Linen, Linara, Bardal, Capture, Remix, Natural Linen, Re-wool
Fabric group 2	Savoy, Barnum, Steelcut Trio, Fiord, Hallingdal, Ruskin, Loop
Fabric group 3	Vidar, Clay, Sunniva, Divina Melange
Fabric group 4	Sisu, Elle, Safire, Cotil
Fabric group 5	Gentle, Grand Mohair
Leather group 0	Vice
Leather group 1	Omni
Leather group 2	Trace, Primo
Leather group 3	Max
Leather group 4	Nubuck, Vegeta, Organic, Cera

Model 4213

Pato Paper 4 Leg Armchair Papershell seat



Designed by Welling / Ludvik, 2025

Stacking chair with armrests. Shell made of Papershell cellulose composite, a material completely free of fossil carbon and 100% biogenic. Moulded in Sweden. Mounted on a steel tube base, chromed or powder coated, with visible black screws in the seat. Mounted with plastic glides.

Modeldetails

0,48 m³ Packaging dimensions:
6,6 kg / L: 59 cm W: 63 cm H: 89 cm
5,9 kg



Essential Assortment

Pre-configured

Item number	Shell	Frame	Price
4213774000513	Papershell w/black screws, FSC Mix 70%	Black	515
4213771000513	Papershell w/black screws, FSC Mix 70%	Chrome	515

Essential variants are delivered with plastic glides

Stackable: 25 pcs. on trolley, 13 pcs. on floor.

Extra charge for

Glides with felt:	+12
Other standard frame colours:	+35

Certifications

FSC® certified

Model 4214

Pato Paper 4 Leg Armchair Seat upholstered



Designed by Welling / Ludvik, 2025

Stacking chair with armrests and upholstered seat. Stacking chair with upholstered seat. Shell made of Papershell cellulose composite, a material completely free of fossil carbon and 100% biogenic. Moulded in Sweden. With a mounted plywood seat with HR or CMHR foam, covered in fabric or leather. Shell mounted on a steel tube base, chromed or powder coated. Mounted with plastic glides.

Modeldetails

0,48 m³ Packaging dimensions:
7,1 kg / L: 58,5 cm W: 61 cm H: 94 cm
6,3 kg

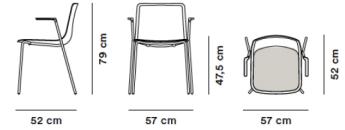

Order configuration

Frame: Chrome or black.

	Papershell
Fabric group 0	665
Fabric group 1	690
Fabric group 2	730
Fabric group 3	795
Fabric group 4	810
Fabric group 5	855
C.O.M. fabric	690
Leather group 0	700
Leather group 1	725
Leather group 2	785
Leather group 3	850
Leather group 4	875
C.O.M. leather	725

Fabric consumption: 0,5 m. Leather consumption: 0,4 m²

Stackable: 15 pcs. on trolley, 10 pcs. on floor.

Extra charge for

Glides with felt: +12
Other standard frame colours: +35

Certifications

FSC® certified

Recommended upholstery

Fabric group 0	Connect
Fabric group 1	Erik, Gran Linen, Linara, Bardal, Capture, Remix, Natural Linen, Re-wool
Fabric group 2	Savoy, Barnum, Steelcut Trio, Fiord, Hallingdal, Ruskin, Loop
Fabric group 3	Vidar, Clay, Sunniva, Divina Melange
Fabric group 4	Sisu, Elle, Safire, Cotil
Fabric group 5	Gentle, Grand Mohair
Leather group 0	Vice
Leather group 1	Omni
Leather group 2	Trace, Primo
Leather group 3	Max
Leather group 4	Nubuck, Vegeta, Organic, Cera

Model 4103

Pato Paper Sledge Chair Papershell seat



Designed by Welling / Ludvik, 2025

Stacking chair. Shell made of Papershell cellulose composite, a material completely free of fossil carbon and 100% biogenic. Moulded in Sweden. Mounted on a base of solid steel, chromed or powder coated, with visible black screws in the seat. Mounted with plastic glides.

Modeldetails

0,36 m³ Packaging dimensions:
7,5 kg / L: 58 cm W: 64 cm H: 95 cm
6,2 kg



Essential Assortment

Pre-configured

Item number	Shell	Frame	Price
41037740040	Papershell w/black screws, FSC Mix 70%	Black	365
41037710040	Papershell w/black screws, FSC Mix 70%	Chrome	365

Essential variants are delivered with plastic glides

Stackable: 25 pcs. on trolley, 18 pcs. on floor.

Extra charge for

Glides with felt:	+12
Other standard frame colours:	+30

Certifications

FSC® certified

Model 4104

Pato Paper Sledge Chair Seat upholstered



Designed by Welling / Ludvik, 2025

Stacking chair with upholstered seat. Shell made of Papershell cellulose composite, a material completely free of fossil carbon and 100% biogenic. Moulded in Sweden. With a mounted plywood seat with HR or CMHR foam, covered in fabric or leather. Shell mounted on a base of solid steel, chromed or powder coated, with visible black screws in the seat. Mounted with plastic glides.

Modeldetails

0,36 m³ Packaging dimensions:
8 kg / L: 58,5 cm W: 61 cm H: 94 cm
6,7 kg



Order configuration

Frame: Chrome or black.

	Papershell
Fabric group 0	535
Fabric group 1	560
Fabric group 2	595
Fabric group 3	650
Fabric group 4	660
Fabric group 5	705
C.O.M. fabric	560
Leather group 0	575
Leather group 1	580
Leather group 2	650
Leather group 3	700
Leather group 4	725
C.O.M. leather	580

Fabric consumption: 0,5 m. Leather consumption: 0,4 m²

Stackable: 15 pcs. on trolley, 10 pcs. on floor.

Extra charge for

Glides with felt: +12
Other standard frame colours: +30

Certifications

FSC® certified

Recommended upholstery

Fabric group 0	Connect
Fabric group 1	Erik, Gran Linen, Linara, Bardal, Capture, Remix, Natural Linen, Re-wool
Fabric group 2	Savoy, Barnum, Steelcut Trio, Fiord, Hallingdal, Ruskin, Loop
Fabric group 3	Vidar, Clay, Sunniva, Divina Melange
Fabric group 4	Sisu, Elle, Safire, Cotil
Fabric group 5	Gentle, Grand Mohair
Leather group 0	Vice
Leather group 1	Omni
Leather group 2	Trace, Primo
Leather group 3	Max
Leather group 4	Nubuck, Vegeta, Organic, Cera

Model 4113

Pato Paper Sledge Armchair Papershell seat



Designed by Welling / Ludvik, 2025

Stacking chair with armrests. Shell made of Papershell cellulose composite, a material completely free of fossil carbon and 100% biogenic. Moulded in Sweden. Mounted on a base of solid steel, chromed or powder coated, with visible black screws in the seat. Mounted with plastic glides.

Modeldetails

0,36 m³ Packaging dimensions:
8,3 kg / L: 59 cm W: 61 cm H: 94 cm
6,8 kg



Essential Assortment

Pre-configured

Item number	Shell	Frame	Price
4113774004012	Papershell w/black screws, FSC Mix 70%	Black	515
4113771004012	Papershell w/black screws, FSC Mix 70%	Chrome	515

Essential variants are delivered with plastic glides

Stackable: 25 pcs. on trolley, 13 pcs. on floor.

Extra charge for

Glides with felt:	+12
Other standard frame colours:	+35

Certifications

FSC® certified

Model 4114

Pato Paper Sledge Armchair

Seat upholstered



Designed by Welling / Ludvik, 2025

Stacking chair with armrests and upholstered seat. Shell made of Papershell cellulose composite, a material completely free of fossil carbon and 100% biogenic. Moulded in Sweden. With a mounted plywood seat with HR or CMHR foam, covered in fabric or leather. Shell mounted on a base of solid steel, chromed or powder coated, with visible black screws in the seat. Mounted with plastic glides.

Modeldetails

0,36 m³ Packaging dimensions:
8,8 kg / L: 58,5 cm W: 61 cm H: 94 cm
7,3 kg



Order configuration

Frame: Chrome or black.

	Papershell
Fabric group 0	665
Fabric group 1	690
Fabric group 2	730
Fabric group 3	795
Fabric group 4	810
Fabric group 5	855
C.O.M. fabric	690
Leather group 0	700
Leather group 1	725
Leather group 2	785
Leather group 3	850
Leather group 4	875
C.O.M. leather	725

Fabric consumption: 0,5 m. Leather consumption: 0,4 m²

Stackable: 15 pcs. on trolley, 10 pcs. on floor.

Extra charge for

Glides with felt: +12
Other standard frame colours: +35

Certifications

FSC® certified

Recommended upholstery

Fabric group 0	Connect
Fabric group 1	Erik, Gran Linen, Linara, Bardal, Capture, Remix, Natural Linen, Re-wool
Fabric group 2	Savoy, Barnum, Steelcut Trio, Fiord, Hallingdal, Ruskin, Loop
Fabric group 3	Vidar, Clay, Sunniva, Divina Melange
Fabric group 4	Sisu, Elle, Safire, Cotil
Fabric group 5	Gentle, Grand Mohair
Leather group 0	Vice
Leather group 1	Omni
Leather group 2	Trace, Primo
Leather group 3	Max
Leather group 4	Nubuck, Vegeta, Organic, Cera

Model 4303



Pato Paper Sledge Barstool Papershell seat

Designed by Welling / Ludvik, 2025

Barstool. Shell made of Papershell cellulose composite, a material completely free of fossil carbon and 100% biogenic. Moulded in Sweden. Mounted on a base of solid steel, chromed or powder coated, with visible black screws in the seat. Mounted with plastic glides. Please specify bar or counter height.

Modeldetails

0,34 m³

8 kg /
7,5 kg

Packaging dimensions:

L: 57 cm W: 52 cm H: 115 cm

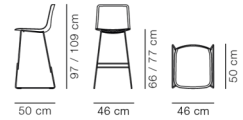

Essential Assortment

Pre-configured

Item number	Shell	Frame	Height	Price
4303774004077	Papershell w/black screws, FSC Mix 70%	Black	Sh 77 cm	470
4303771004077	Papershell w/black screws, FSC Mix 70%	Chrome	Sh 77 cm	470
4303771004066	Papershell w/black screws, FSC Mix 70%	Chrome	Sh 66 cm	470
4303774004066	Papershell w/black screws, FSC Mix 70%	Black	Sh 66 cm	470

Essential variants are delivered with plastic glides

Extra charge for

Glides with felt:	+12
Other standard frame colours:	+45

Certifications

FSC® certified

Model 4304



Pato Paper Sledge Barstool Seat upholstered

Designed by Welling / Ludvik, 2025

Barstool with upholstered seat. Shell made of Papershell cellulose composite, a material completely free of fossil carbon and 100% biogenic. Moulded in Sweden. With a mounted plywood seat with HR or CMHR foam, covered in fabric or leather. Shell mounted on a base of solid steel, chromed or powder coated, with visible black screws in the seat. Mounted with plastic glides. Please specify bar or counter height.

Modeldetails

0,34 m³ Packaging dimensions:
8,5 kg / 8 kg L: 51,5 cm W: 56 cm H: 113 cm

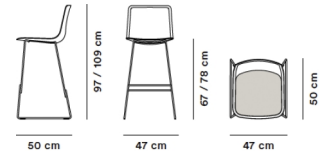

Order configuration

Frame: Chrome or black.
Bar or counter height.

	Papershell
Fabric group 0	640
Fabric group 1	660
Fabric group 2	700
Fabric group 3	750
Fabric group 4	765
Fabric group 5	810
C.O.M. fabric	660
Leather group 0	675
Leather group 1	685
Leather group 2	750
Leather group 3	805
Leather group 4	830
C.O.M. leather	685

Fabric consumption: 0,5 m. Leather consumption: 0,4 m²

Extra charge for

Glides with felt: +12
Other standard frame colours: +45

Certifications

FSC® certified

Recommended upholstery

Fabric group 0	Connect
Fabric group 1	Erik, Gran Linen, Linara, Bardal, Capture, Remix, Natural Linen, Re-wool
Fabric group 2	Savoy, Barnum, Steelcut Trio, Fiord, Hallingdal, Ruskin, Loop
Fabric group 3	Vidar, Clay, Sunniva, Divina Melange
Fabric group 4	Sisu, Elle, Safire, Cotil
Fabric group 5	Gentle, Grand Mohair
Leather group 0	Vice
Leather group 1	Omni
Leather group 2	Trace, Primo
Leather group 3	Max
Leather group 4	Nubuck, Vegeta, Organic, Cera

Model
4188

Pato Accessories

Coupling device

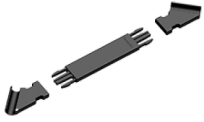

Designed by Fredericia Furniture, 2025

Black coupling device in black plastic for Pato 4-leg chair & armchair and Sledge chair & armchair. The device is removable and can be retrofitted. When not in use, the middle section can be removed. Removing the coupling device is not required for stacking the chairs.

Order configuration

	for Pato 4 leg chair & armchair	for Pato sledge chair & armchair
	10	10

Model 1004

Pato / Lynderup Accessories Transport trolley



Designed by Fredericia Furniture

Transport trolley for the stackable chairs Lynderup, Pato Sledge and Pato 4-Leg.
Black powder coated steel.

Modeldetails

0,77 m³ Packaging dimensions:
24 kg / L: 90 cm W: 59 cm H: 102 cm
18 kg

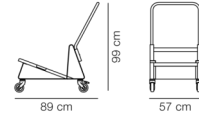

Order configuration

Black	1.060
-------	-------

Model 1068

Pato Accessories Chair suspensions for barstool

Designed by Fredericia Furniture

Chair suspensions in black powder coated steel. Can only be used on tables without an apron at the edge. Only one template is needed for mounting all chair suspensions.

Order configuration

	No template	Template enclosed
Black	90	210

Model 1069

Pato Accessories Chair suspensions for chair

Designed by Fredericia Furniture

Chair suspensions in black powder coated steel. Can only be used on tables without an apron at the edge. Only one template is needed for mounting all chair suspensions.

Order configuration

	No template	Template enclosed
Black	90	210

Pato Trolleys

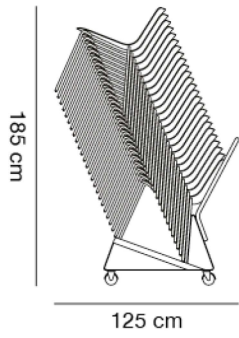

Pato 4 Leg Chair
Unupholstered: 25 Units
Fully upholstered: 15 Units

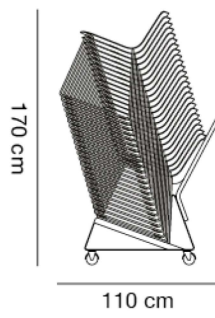

Pato Sledge Chair
Unupholstered: 25 Units
Fully upholstered: 15 Units

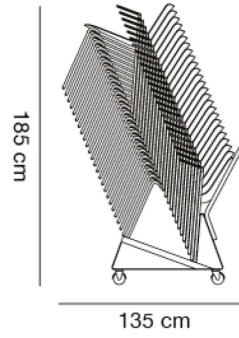

Pato 4 Leg Armchair
Unupholstered: 25 Units
Fully upholstered: 15 Units

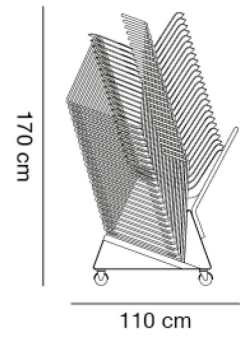

Pato Sledge Armchair
Unupholstered: 25 Units
Fully upholstered: 15 Units

Pato coupling

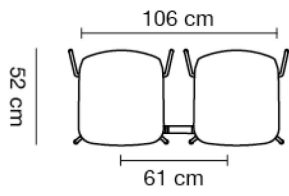

Pato 4 Leg Chair
Seat coupling

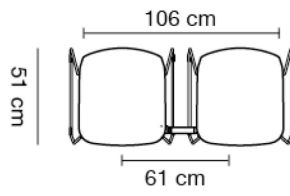

Pato Sledge Chair
Base coupling

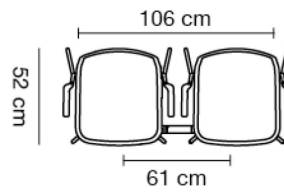

Pato 4 Leg Armchair
Seat coupling

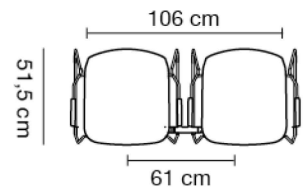

Pato Sledge Armchair
Base coupling

Model 6830

Pioneer Stool, ht 46 cm



Designed by Maria Bruun, 2023

Stackable stool with a base in solid wood. Seat consists of an inner construction of a MDF core with moulded polyurethane foam, either HR or CMHR foam and upholstered with a removable fabric cover with zippers or non-removable cover in leather. Upholstered seat is removable. Metal screws and fittings. Mounted with plastic glides, felt glides are available.

Modeldetails

0,09 m³ Packaging dimensions:
5,5 kg / 3,5 kg L: 42 cm W: 42 cm H: 50 cm

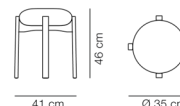

Essential Assortment

Pre-configured

Item number	Upholstery	Frame	Price
6830448550894400	Odino RC41	Beech Dark Brown, FSC Mix 70%	530
6830448560897400	Odino NE22	Beech oiled, FSC Mix 70%	530
6830448580898400	Odino RC43	Beech Bordeaux, FSC Mix 70%	530
6830448540854400	Odino PV82	Oak lacquer, FSC Mix 70%	650
6830002070854400	Hallingdal 200	Oak lacquer, FSC Mix 70%	690
6830508610855400	Leather Primo 86-1, Dark brown	Smoked oak stained lacquer, FSC Mix 70%	795
6830500900854400	Leather Vegeta 90, Natural	Oak lacquer, FSC Mix 70%	800

Essential variants are delivered with plastic glides and HR foam

Order configuration

Fabric group 0: Odino fabric

	Beech: black lacquered, Dark brown lacquered, Bordeaux, Oiled	Oak lacquered	Smoked oak stained, lacquered
Fabric group 0	530	650	705
Fabric group 1	590	650	705
Fabric group 2	630	690	750
Fabric group 3	660	720	775
Fabric group 4	705	770	825
Fabric group 5	800	865	920
C.O.M. fabric	600	660	720
Leather group 1	640	700	755
Leather group 2	675	740	795
Leather group 3	685	745	795
Leather group 4	735	800	850
Leather group 5	830	895	950
C.O.M. leather	650	715	770

Fabric consumption: 0,5 m. Leather consumption: 0,5 m²

Stackable: 6 pcs. on floor.

Certifications

FSC® certified

EN 1022:2005, EN 16139:2013 (L2)

Recommended upholstery

Fabric group 1	Re-wool, Capture, Bardal, Linara, Erik
Fabric group 2	Steelcut Trio, Hallingdal, Barnum, Fiord, Loop, Ruskin
Fabric group 3	Divina Melange, Vidar, Sunniva, Clay, Zero
Fabric group 4	Elle, Safire
Fabric group 5	Gentle
Leather group 1	Omni
Leather group 2	Primo, Trace
Leather group 3	Max
Leather group 4	Nubuck, Vegeta, Organic

Model 6831



Pioneer Stool, ht. 67 or 77 cm

Designed by Maria Bruun, 2023

Stool in two optional heights with a base in solid wood and footrest in plywood. Seat consists of an inner construction of a MDF core with moulded polyurethane foam, either HR or CMHR foam and upholstered with a removable fabric cover with zippers or non-removable cover in leather. Upholstered seat is removable. Metal screws and fittings. Mounted with plastic glides, felt glides are available. Please specify counter- or bar height.

Modeldetails

0,15 m³ Packaging dimensions:
6,5 kg / 4,5 kg L: 42 cm W: 42 cm H: 82 cm

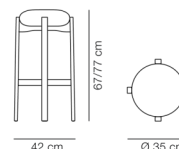

Essential Assortment

Pre-configured

Item number	Upholstery	Frame	Height	Price
68314485508940177400	Odino RC41	Beech Dark Brown, FSC Mix 70%	Sh 77 cm	705
68314485608970177400	Odino NE22	Beech oiled, FSC Mix 70%	Sh 77 cm	705
68314485808980177400	Odino RC43	Beech Bordeaux, FSC Mix 70%	Sh 77 cm	705
68314485408540177400	Odino PV82	Oak lacquer, FSC Mix 70%	Sh 77 cm	885
68310020708540177400	Hallingdal 200	Oak lacquer, FSC Mix 70%	Sh 77 cm	935
68315086108550177400	Leather Primo 86-1, Dark brown	Smoked oak stained lacquer, FSC Mix 70%	Sh 77 cm	1.020
68315009008540177400	Leather Vegeta 90, Natural	Oak lacquer, FSC Mix 70%	Sh 77 cm	1.025

Essential variants are delivered with plastic glides, HR foam and bar height

Order configuration

Bar or counter height.

Fabric group 0: Odino fabric

	Beech: black lacquered, Dark brown lacquered, Bordeaux, Oiled	Oak lacquered	Smoked oak stained, lacquered
Fabric group 0	705	885	945
Fabric group 1	765	885	945
Fabric group 2	810	935	990
Fabric group 3	835	960	1.020
Fabric group 4	880	1.010	1.065
Fabric group 5	970	1.105	1.155
C.O.M. fabric	780	900	960
Leather group 1	815	935	995
Leather group 2	850	970	1.020
Leather group 3	855	980	1.035
Leather group 4	900	1.025	1.075
Leather group 5	990	1.120	1.165
C.O.M. leather	830	955	1.015

Fabric consumption: 0,5 m. Leather consumption: 0,5 m²

Certifications

FSC® certified
EN 1022:2005, EN 16139:2013 (L2)

Recommended upholstery

Fabric group 1	Linara, Capture, Erik, Bardal, Re-wool
Fabric group 2	Steelcut Trio, Fiord, Loop, Barnum, Ruskin, Hallingdal
Fabric group 3	Clay, Sunniva, Divina Melange, Vidar, Zero
Fabric group 4	Elle, Safire
Fabric group 5	Gentle
Leather group 1	Omni
Leather group 2	Primo, Trace
Leather group 3	Max
Leather group 4	Nubuck, Vegeta, Organic

Model P6830

Pioneer Accessories Loose cover or seat



Designed by Maria Bruun, 2024

Seat mounted with a cover or a loose fabric cover for re-upholstery of Pioneer stool.
Professional assistance is recommended for mounting the loose textile cover.

Order configuration

	Seat with cover	Loose cover
Fabric group 1	350	205
Fabric group 2	380	235
Fabric group 3	410	265
Fabric group 4	460	315
Fabric group 5	560	420
C.O.M. fabric	350	205
Leather group 1	465	
Leather group 2	485	
Leather group 3	510	
Leather group 4	550	
Leather group 5	655	
C.O.M. leather	465	

Fabric consumption: 0,5 m. Leather consumption: 0,5 m²

Recommended upholstery

Fabric group 1	Capture, Bardal, Re-wool, Linara, Erik
Fabric group 2	Hallingdal, Barnum, Loop, Steelcut Trio, Fiord, Ruskin
Fabric group 3	Divina Melange, Zero, Vidar, Sunniva, Clay
Fabric group 4	Elle, Safire
Fabric group 5	Gentle
Leather group 1	Omni
Leather group 2	Primo, Trace
Leather group 3	Max
Leather group 4	Nubuck, Vegeta, Organic

Model 3418



Plan Armchair Fully upholstered

Designed by Edward Barber & Jay Osgerby, 2024

Fully upholstered chair with steel tube frame, powder coated or brushed steel. Inner backrest frame in steel with moulded foam and inner seat in plywood with HR or CMHR foam covered in fabric or leather. Mounted with plastic glides. Felt glides available.

Modeldetails

0,185 m³ Packaging dimensions:
9 kg / 7,5 kg L: 65 cm W: 57 cm H: 101 cm

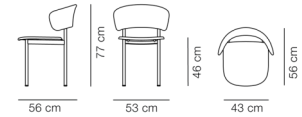

Essential Assortment

Pre-configured

Item number	Upholstery	Frame	Price
3418400193000561	Re-Wool 198	Black	700
3418537041420561	Steelcut Quartet 924	Modernist green	730
3418538041400561	Steelcut Quartet 554	Bordeaux	730
3418500193110561	Re-Wool 128	Brushed steel	770
3418400513010561	Leather Omni 301, Black	Black	780
3418400500950561	Leather Max 95, Cognac	Black	820
3418500513010561	Leather Omni 301, Black	Brushed steel	855
3418500500950561	Leather Max 95, Cognac	Brushed steel	895

Essential variants are delivered with plastic glides and HR foam

Order configuration

Frame: Brushed Steel or standard colours: Black, Modernist green, Bordeaux, Chalk, Signal blue.

	Standard colours	Brushed Steel
Fabric group 0	650	705
Fabric group 1	700	770
Fabric group 2	730	800
Fabric group 3	760	830
Fabric group 4	815	885
Fabric group 5	880	950
C.O.M. fabric	700	770
Leather group 0	755	830
Leather group 1	780	855
Leather group 2	805	890
Leather group 3	820	895
Leather group 4	855	930
Leather group 5	920	1.000
C.O.M. leather	780	855

Fabric consumption: 1,1 m. Leather consumption: 1,1 m²

Spare parts: Glides with or without felt (R3412G)

Extra charge for

Dual colour upholstery on seat and back within the same fabric/leather +70

Certifications

EU Ecolabel variants: Brushed Steel, Modernist green, Bordeaux, Chalk, Signal blue or black powder-coated frame together with HR foam and upholstery in Omni leather or Connect, Remix, Re-wool, Steelcut Quartet fabric

FSC® certified

ANSI/BIFMA X5.4-2020, EN 1022:2005, EN 16139:2013 (L2), ANSI/BIFMA X7.1/M7.1/e3-2019 VOC test (tested with HR foam and EU Ecolabel fabric)

Recommended upholstery

Fabric group 0	Connect
Fabric group 1	Erik, Linara, Bardal, Capture, Remix, Natural Linen, Re-wool
Fabric group 2	Barnum, Steelcut Trio, Fiord, Hallingdal, Ruskin, Loop, Steelcut Quartet
Fabric group 3	Vidar, Clay, Sunniva, Divina Melange
Fabric group 4	Sisu, Elle, Safire
Fabric group 5	Gentle
Leather group 0	Vice
Leather group 1	Omni
Leather group 2	Primo, Trace
Leather group 3	Max
Leather group 4	Nubuck, Vegeta, Organic, Cera

Model 3438



Plan Arm Barstool Fully upholstered

Designed by Edward Barber & Jay Osgerby, 2024

Fully upholstered barstool with steel tube frame, powder coated or brushed steel. Inner backrest frame in steel with moulded foam and inner seat in plywood with HR or CMHR foam covered in fabric or leather. Mounted with plastic glides. Felt glides available. Please specify bar or counter height.

Modeldetails

0,39 m³ Packaging dimensions:
13 kg / L: 58 cm W: 58 cm H: 115 cm
10 kg

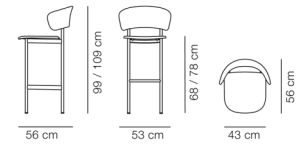

Essential Assortment

Pre-configured

Item number	Upholstery	Frame	Height	Price
343840019300078561	Re-Wool 198	Black	Sh 78 cm	1.020
343840051301078561	Leather Omni 301, Black	Black	Sh 78 cm	1.075
343853704142078561	Steelcut Quartet 924	Modernist green	Sh 78 cm	1.080
343853804140078561	Steelcut Quartet 554	Bordeaux	Sh 78 cm	1.080
343840050095078561	Leather Max 95, Cognac	Black	Sh 78 cm	1.155
343850019311078561	Re-Wool 128	Brushed steel	Sh 78 cm	1.235
343850051301078561	Leather Omni 301, Black	Brushed steel	Sh 78 cm	1.285
343850050095078561	Leather Max 95, Cognac	Brushed steel	Sh 78 cm	1.350

Essential variants are delivered with plastic glides, HR foam and bar height

Order configuration

Frame: Brushed Steel or standard colours: Black, Modernist green, Bordeaux, Chalk, Signal blue.
Bar or counter height.

	Standard colours	Brushed Steel
Fabric group 0	885	1.060
Fabric group 1	1.020	1.235
Fabric group 2	1.080	1.290
Fabric group 3	1.135	1.345
Fabric group 4	1.235	1.445
Fabric group 5	1.420	1.625
C.O.M. fabric	1.020	1.235
Leather group 0	1.020	1.230
Leather group 1	1.075	1.285
Leather group 2	1.125	1.335
Leather group 3	1.155	1.350
Leather group 4	1.265	1.460
Leather group 5	1.455	1.645
C.O.M. leather	1.075	1.285

Fabric consumption: 1,1 m. Leather consumption: 1,1 m²

Spare parts: Glides with or without felt (R3412G)

Extra charge for

Dual colour upholstery on seat and back within the same fabric/leather +70

Certifications

EU Ecolabel variants: Brushed Steel, Modernist green, Bordeaux, Chalk, Signal blue or black powder-coated frame together with HR foam and upholstery in Omni leather or Connect, Remix, Re-wool, Steelcut Quartet fabric

FSC® certified

ANSI/BIFMA X5.4-2020, EN 1022:2005, EN 16139:2013 (L2), ANSI/BIFMA X7.1/M7.1/e3-2019 VOC test (tested with HR foam and EU Ecolabel fabric)

Recommended upholstery

Fabric group 0	Connect
Fabric group 1	Erik, Re-wool, Remix, Capture, Bardal, Linara, Natural Linen
Fabric group 2	Hallingdal, Steelcut Trio, Fiord, Ruskin, Barnum, Loop, Steelcut Quartet
Fabric group 3	Vidar, Divina Melange, Sunniva, Clay
Fabric group 4	Elle, Safire, Sisu
Fabric group 5	Gentle
Leather group 0	Vice
Leather group 1	Omni
Leather group 2	Primo, Trace
Leather group 3	Max
Leather group 4	Nubuck, Vegeta, Organic, Cera

Model 3412



Plan Chair Wooden seat

Designed by Edward Barber & Jay Osgerby, 2022

Chair with steel tube frame and plywood veneer seat and back finished with water-based lacquer. Frame is powder coated tubular steel mounted with plastic glides. Felt glides available.

Modeldetails

0,28 m³ Packaging dimensions:
8,2 kg / L: 46 cm W: 60 cm H: 100 cm
6,8 kg

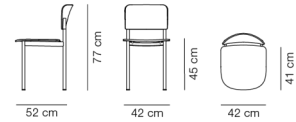

Essential Assortment

Pre-configured

Item number	Wood	Frame	Price
341240020256	Oak lacquer, FSC Mix 70%	Black	360
341240022356	Black ash, FSC Mix 70%	Black	360

Essential variants are delivered with plastic glides

Order configuration

	Oak lacquered	Black ash
Black	360	360
Modernist green	420	420
Bordeaux	420	420
Chalk	420	420
Signal Blue	420	420

Spare parts: Glides with or without felt (R3412G)

Certifications

EU Ecolabel

FSC® certified

ANSI/BIFMA X5.4-2020, ANSI/BIFMA X7.1/M7.1/e3-2019 VOC test (tested with HR foam and EU Ecolabel fabric)

Model 3413



Plan Chair Seat upholstered

Designed by Edward Barber & Jay Osgerby, 2022

Chair with steel tube frame, fully upholstered seat, plywood veneer back finished with water-based lacquer. Inner seat in plywood with HR or CMHR foam covered in fabric or leather. Frame is powder coated tubular steel mounted with plastic glides. Felt glides available.

Modeldetails

0,28 m³ Packaging dimensions:
8,2 kg / L: 46 cm W: 60 cm H: 100 cm
6,7 kg

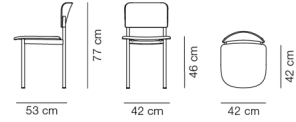

Essential Assortment

Pre-configured

Item number	Upholstery	Wood	Frame	Price
341340020219311056	Re-Wool 128	Oak lacquer, FSC Mix 70%	Black	515
341340022319300056	Re-Wool 198	Black ash, FSC Mix 70%	Black	515
341340022351301056	Leather Omni 301, Black	Black ash, FSC Mix 70%	Black	570

Essential variants are delivered with plastic glides and HR foam

Order configuration

Frame: Black, Modernist green or Bordeaux, Chalk, Signal blue.

	Oak lacquered	Black ash
Fabric group 0	470	470
Fabric group 1	515	515
Fabric group 2	545	545
Fabric group 3	575	575
Fabric group 4	635	635
Fabric group 5	700	700
C.O.M. fabric	515	515
Leather group 0	525	525
Leather group 1	570	570
Leather group 2	585	585
Leather group 3	600	600
Leather group 4	640	640
Leather group 5	710	710
C.O.M. leather	570	570

Fabric consumption: 0,6 m. Leather consumption: 0,7 m²

Spare parts: Glides with or without felt (R3412G)

Certifications

EU Ecolabel variants: Modernist Green, Bordeaux, Chalk, Signal blue or black powder-coated frame together with HR foam and upholstery in Omni leather or Connect, Remix, Re-wool, Steelcut Quartet fabric

FSC® certified

ANSI/BIFMA X5.4-2020, ANSI/BIFMA X7.1/M7.1/e3-2019 VOC test (tested with HR foam and EU Ecolabel fabric)

Recommended upholstery

Fabric group 0	Connect
Fabric group 1	Linara, Bardal, Capture, Remix, Natural Linen, Re-wool, Gran Linen, Erik
Fabric group 2	Savoy, Barnum, Steelcut Trio, Fiord, Hallingdal, Ruskin, Loop, Steelcut Quartet
Fabric group 3	Vidar, Clay, Sunniva, Divina Melange, Tonus, Zero
Fabric group 4	Elle, Safire, Sisu, Cotil
Fabric group 5	Gentle, Grand Mohair
Leather group 0	Vice
Leather group 1	Omni
Leather group 2	Primo, Trace
Leather group 3	Max
Leather group 4	Nubuck, Organic, Vegeta, Cera

Model 3414



Plan Chair Fully upholstered

Designed by Edward Barber & Jay Osgerby, 2022

Fully upholstered chair with steel tube frame, powder coated or brushed steel.
Inner backrest frame in steel with moulded foam and inner seat in plywood with HR or CMHR foam covered in fabric or leather.
Mounted with plastic glides. Felt glides available.

Modeldetails

0,28 m³ Packaging dimensions:
8 kg / 6,5 kg L: 46 cm W: 60 cm H: 100 cm

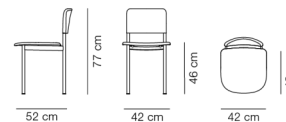

Essential Assortment

Pre-configured

Item number	Upholstery	Frame	Price
3414400193000561	Re-Wool 198	Black	595
3414537041420561	Steelcut Quartet 924	Modernist green	625
3414538041400561	Steelcut Quartet 554	Bordeaux	625
3414500193110561	Re-Wool 128	Brushed steel	665
3414400513010561	Leather Omni 301, Black	Black	675
3414400500950561	Leather Max 95, Cognac	Black	715
3414500513010561	Leather Omni 301, Black	Brushed steel	750
3414500500950561	Leather Max 95, Cognac	Brushed steel	795

Essential variants are delivered with plastic glides and HR foam

Order configuration

Frame: Brushed Steel or standard colours: Black, Modernist green, Bordeaux, Chalk, Signal blue.

	Standard colours	Brushed Steel
Fabric group 0	530	590
Fabric group 1	595	665
Fabric group 2	625	695
Fabric group 3	655	725
Fabric group 4	710	785
Fabric group 5	775	850
C.O.M. fabric	595	665
Leather group 0	650	730
Leather group 1	675	750
Leather group 2	705	785
Leather group 3	715	795
Leather group 4	750	830
Leather group 5	820	900
C.O.M. leather	675	750

Fabric consumption: 1 m. Leather consumption: 1 m²

Spare parts: Glides with or without felt (R3412G)

Extra charge for

Dual colour upholstery on seat and back within the same fabric/leather +70

Certifications

EU Ecolabel variants: HR foam and upholstery in Omni leather 301 black or Connect, Remix, Re-wool fabric

FSC® certified

ANSI/BIFMA X5.4-2020, EN 1022:2005, EN 16139:2013 (L2), ANSI/BIFMA X7.1/M7.1/e3-2019 VOC test (tested with HR foam and EU Ecolabel fabric)

Recommended upholstery

Fabric group 0	Connect
Fabric group 1	Linara, Bardal, Capture, Remix, Natural Linen, Re-wool, Gran Linen, Erik
Fabric group 2	Savoy, Barnum, Steelcut Trio, Fiord, Hallingdal, Ruskin, Loop, Steelcut Quartet
Fabric group 3	Vidar, Clay, Sunniva, Divina Melange, Tonus, Zero
Fabric group 4	Elle, Safire, Sisu, Cotil
Fabric group 5	Gentle, Grand Mohair
Leather group 0	Vice
Leather group 1	Omni
Leather group 2	Primo, Trace
Leather group 3	Max
Leather group 4	Nubuck, Organic, Vegeta, Cera

Model 3432



Plan Barstool Wooden seat

Designed by Edward Barber & Jay Osgerby, 2023

Barstool with steel tube frame and plywood veneer seat and back finished with water-based lacquer.
Frame is powder coated tubular steel mounted with plastic glides. Felt glides available. Please specify bar or counter height.

Modeldetails

0,273 m³ Packaging dimensions:
11,6 kg / 8,8 kg L: 54 cm W: 46 cm H: 110 cm

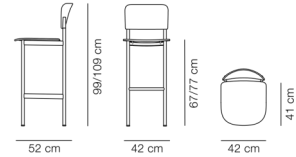

Essential Assortment

Pre-configured

Item number	Wood	Frame	Height	Price
34324002027856	Oak lacquer, FSC Mix 70%	Black	Sh 78 cm	600
34324002237856	Black ash, FSC Mix 70%	Black	Sh 78 cm	600

Essential variants are delivered with plastic glides bar height

Order configuration

Bar or counter height.

	Oak lacquered	Black ash
Black	600	600
Modernist green	625	625
Bordeaux	625	625
Chalk	625	625
Signal Blue	625	625

Spare parts: Glides with or without felt (R3412G)

Certifications

EU Ecolabel

FSC® certified

ANSI/BIFMA X5.4-2020, ANSI/BIFMA X7.1/M7.1/e3-2019 VOC test (tested with HR foam and EU Ecolabel fabric)

Model 3433



Plan Barstool Seat upholstered

Designed by Edward Barber & Jay Osgerby, 2023

Barstool with steel tube frame, fully upholstered seat, plywood veneer back finished with water-based lacquer. Inner seat in plywood with HR or CMHR foam covered in fabric or leather.
Frame is powder coated tubular steel mounted with plastic glides. Felt glides available. Please specify bar or counter height.

Modeldetails

0,273 m³ Packaging dimensions:
11,6 kg / 8,8 kg L: 54 cm W: 46 cm H: 110 cm

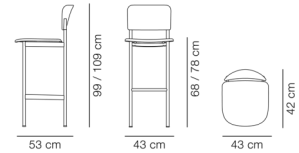

Essential Assortment

Pre-configured

Item number	Upholstery	Wood	Frame	Price
34334002021931107856	Re-Wool 128	Oak lacquer, FSC Mix 70%	Black	780
34334002231930007856	Re-Wool 198	Black ash, FSC Mix 70%	Black	780
34334002235130107856	Leather Omni 301, Black	Black ash, FSC Mix 70%	Black	830

Essential variants are delivered with plastic glides, HR foam and bar height

Order configuration

Frame: Black, Modernist green or Bordeaux, Chalk, Signal blue.
Bar or counter height.

	Oak lacquered	Black ash
Fabric group 0	705	705
Fabric group 1	780	780
Fabric group 2	815	815
Fabric group 3	845	845
Fabric group 4	910	910
Fabric group 5	1.020	1.020
C.O.M. fabric	780	780
Leather group 0	790	790
Leather group 1	830	830
Leather group 2	865	865
Leather group 3	880	880
Leather group 4	955	955
Leather group 5	1.095	1.095
C.O.M. leather	830	830

Fabric consumption: 0,6 m. Leather consumption: 0,7 m²

Spare parts: Glides with or without felt (R3412G)

Certifications

EU Ecolabel variants: Modernist Green, Bordeaux, Chalk, Signal blue or black powder-coated frame together with HR foam and upholstery in Omni leather or Connect, Remix, Re-wool, Steelcut Quartet fabric

FSC® certified

ANSI/BIFMA X5.4-2020, ANSI/BIFMA X7.1/M7.1/e3-2019 VOC test (tested with HR foam and EU Ecolabel fabric)

Recommended upholstery

Fabric group 0	Connect
Fabric group 1	Gran Linen, Linara, Bardal, Capture, Remix, Natural Linen, Re-wool, Erik
Fabric group 2	Savoy, Barnum, Steelcut Trio, Fiord, Hallingdal, Ruskin, Loop, Steelcut Quartet
Fabric group 3	Vidar, Clay, Sunniva, Divina Melange
Fabric group 4	Sisu, Elle, Safire, Cotil
Fabric group 5	Gentle, Grand Mohair
Leather group 0	Vice
Leather group 1	Omni
Leather group 2	Primo, Trace
Leather group 3	Max
Leather group 4	Nubuck, Vegeta, Organic, Cera

Model 3434



Plan Barstool Fully upholstered

Designed by Edward Barber & Jay Osgerby, 2023

Fully upholstered barstool with steel tube frame, powder coated or brushed steel. Inner backrest frame in steel with moulded foam and inner seat in plywood with HR or CMHR foam covered in fabric or leather. Mounted with plastic glides. Felt glides available. Please specify bar or counter height.

Modeldetails

0,273 m³ Packaging dimensions:
12 kg / L: 54 cm W: 46 cm H: 110 cm
9,1 kg

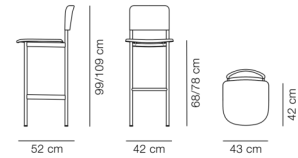

Essential Assortment

Pre-configured

Item number	Upholstery	Frame	Height	Price
343440019300078561	Re-Wool 198	Black	Sh 78 cm	905
343440051301078561	Leather Omni 301, Black	Black	Sh 78 cm	955
343453704142078561	Steelcut Quartet 924	Modernist green	Sh 78 cm	960
343453804140078561	Steelcut Quartet 554	Bordeaux	Sh 78 cm	960
343440050095078561	Leather Max 95, Cognac	Black	Sh 78 cm	1.040
343450019311078561	Re-Wool 128	Brushed steel	Sh 78 cm	1.115
343450051301078561	Leather Omni 301, Black	Brushed steel	Sh 78 cm	1.165
343450050095078561	Leather Max 95, Cognac	Brushed steel	Sh 78 cm	1.235

Essential variants are delivered with plastic glides, HR foam and bar height

Order configuration

Frame: **Brushed Steel** or standard colours: **Black, Modernist green, Bordeaux, Chalk, Signal blue.**
Bar or counter height.

	Standard colours	Brushed Steel
Fabric group 0	765	1.005
Fabric group 1	905	1.115
Fabric group 2	960	1.170
Fabric group 3	1.020	1.225
Fabric group 4	1.120	1.325
Fabric group 5	1.305	1.510
C.O.M. fabric	905	1.115
Leather group 0	905	1.115
Leather group 1	955	1.165
Leather group 2	1.005	1.215
Leather group 3	1.040	1.235
Leather group 4	1.150	1.340
Leather group 5	1.340	1.530
C.O.M. leather	955	1.165

Fabric consumption: 1 m. Leather consumption: 1 m²

Spare parts: Glides with or without felt (R3412G)

Extra charge for

Dual colour upholstery on seat and back within the same fabric/leather +70

Certifications

EU Ecolabel variants: Brushed Steel, Modernist green, Bordeaux, Chalk, Signal blue or black powder-coated frame together with HR foam and upholstery in Omni leather or Connect, Remix, Re-wool, Steelcut Quartet fabric

FSC® certified

ANSI/BIFMA X5.4-2020, EN 1022:2005, EN 16139:2013 (L2), ANSI/BIFMA X7.1/M7.1/e3-2019 VOC test (tested with HR foam and EU Ecolabel fabric)

Recommended upholstery

Fabric group 0	Connect
Fabric group 1	Capture, Bardal, Linara, Remix, Natural Linen, Re-wool, Erik, Gran Linen
Fabric group 2	Savoy, Barnum, Steelcut Trio, Fiord, Hallingdal, Ruskin, Loop, Steelcut Quartet
Fabric group 3	Clay, Sunniva, Divina Melange, Vidar
Fabric group 4	Sisu, Elle, Safire, Cotil
Fabric group 5	Gentle, Grand Mohair
Leather group 0	Vice
Leather group 1	Omni
Leather group 2	Primo, Trace
Leather group 3	Max
Leather group 4	Nubuck, Vegeta, Organic, Cera

Model 3422



Plan Wood Chair Wooden seat

Designed by Edward Barber & Jay Osgerby, 2025

Chair with solid oak frame and plywood veneer seat and back finished with water-based lacquer. Felt glides available.

Modeldetails

0,54 m³ Packaging dimensions:
5,7 kg / 4,6 kg L: 45 cm W: 65 cm H: 95 cm

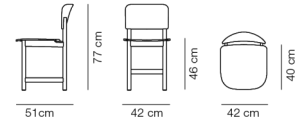

Essential Assortment

Pre-configured

Item number	Wood	Price
342222300	Black ash, FSC Mix 70%	435
342220200	Oak lacquer, FSC Mix 70%	460

Order configuration

	Oak lacquered	Oak oiled	Black ash
	460	460	435

Extra charge for

QuickClick glides with or without felt: +24

Certifications

FSC® certified
EU Ecolabel
EN 1022:2023, EN 16139:2025 (L2)

Model 3423



Plan Wood Chair Seat upholstered

Designed by Edward Barber & Jay Osgerby, 2025

Chair with solid oak frame and plywood veneer seat and back finished with water-based lacquer. Interchangeable seat pad upholstered in HR or CMHR foam with fixed cover in fabric or leather. Plastic or felt glides available.

Modeldetails

0,54 m³ Packaging dimensions:
6,5 kg / 5,4 kg L: 45 cm W: 65 cm H: 95 cm

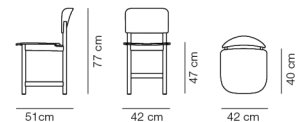

Order configuration

	Oak lacquered	Oak oiled	Black ash
Fabric group 0	585	585	560
Fabric group 1	605	605	575
Fabric group 2	635	635	605
Fabric group 3	665	665	635
Fabric group 4	715	715	690
Fabric group 5	785	785	760
C.O.M. fabric	605	605	575
Leather group 0	600	600	570
Leather group 1	620	620	590
Leather group 2	655	655	625
Leather group 3	665	665	635
Leather group 4	730	730	700
Leather group 5	800	800	770
C.O.M. leather	620	620	590

Fabric consumption: 0,5 m. Leather consumption: 0,5 m²

Extra charge for

QuickClick glides with or without felt: +24

Certifications

FSC® certified

EU Ecolabel variants: Frame in oak lacquered, oak oiled or black ash together with HR foam and upholstery in Omni leather or Connect, Remix, Re-wool, Steelcut Quartet fabric

EN 1022:2023, EN 16139:2025 (L2)

Recommended upholstery

Fabric group 0	Connect
Fabric group 1	Bardal, Capture, Linara, Remix, Re-wool
Fabric group 2	Steelcut Quartet, Barnum, Fiord, Steelcut Trio, Hallingdal, Loop
Fabric group 3	Vidar, Sunniva, Divina Melange, Tonus, Zero
Fabric group 4	Elle, Cotil
Fabric group 5	Grand Mohair
Leather group 0	Vice
Leather group 1	Omni
Leather group 2	Trace, Primo
Leather group 3	Max
Leather group 4	Nubuck, Vegeta, Organic, Cera

Model 3445

Post Armchair Wooden seat



Designed by Cecilie Manz, 2019

Frame of solid wood. Back and seat of moulded veneer. Veneer core in the same wood as top veneer.

Modeldetails

0,25 m³ Packaging dimensions:
7,9 kg / 5 kg L: 53 cm W: 57 cm H: 83 cm

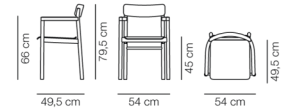

Essential Assortment

Pre-configured

Item number	Wood	Price
344520600	Oak light oil, FSC Mix 70%	815
344522400	Oak black lacquer, FSC Mix 70%	815

Order configuration

	Oak lacquered	Oak oiled	Oak light oil	Oak black lacquered
	860	815	815	815

Extra charge for

QuickClick glides with or without felt: +24

Certifications

FSC® certified
EN 1022:2005, EN 16139:2013 (L1)

Model 3446

Post Armchair Seat upholstered



Designed by Cecilie Manz, 2019

Frame of solid wood. Back and seat of moulded veneer. Veneer core in the same wood as top veneer. Non-removable seat pad upholstered with HR or CMHR foam and covered in fabric or leather.

Modeldetails

0,25 m³ Packaging dimensions:
8,8 kg / 6 kg L: 53 cm W: 57 cm H: 83 cm

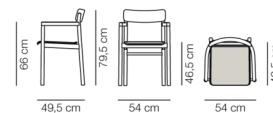

Essential Assortment

Pre-configured

Item number	Upholstery	Wood	Price
344651301022400	Leather Omni 301, Black	Oak black lacquer, FSC Mix 70%	990
344650095020600	Leather Max 95, Cognac	Oak light oil, FSC Mix 70%	1.070

Essential variants only delivered with HR foam

Order configuration

	Oak lacquered	Oak oiled	Oak light oil	Oak black lacquered
Fabric group 0	915	915	915	915
Fabric group 1	980	980	980	980
Fabric group 2	1.025	1.025	1.025	1.025
Fabric group 3	1.060	1.060	1.060	1.060
Fabric group 4	1.130	1.130	1.130	1.130
Fabric group 5	1.225	1.225	1.225	1.225
C.O.M. fabric	980	980	980	980
Leather group 0	920	920	920	920
Leather group 1	990	990	990	990
Leather group 2	1.030	1.030	1.030	1.030
Leather group 3	1.070	1.070	1.070	1.070
Leather group 4	1.105	1.105	1.105	1.105
Leather group 5	1.275	1.275	1.275	1.275
C.O.M. leather	990	990	990	990

Fabric consumption: 0,26 m. Leather consumption: 0,45 m²

Extra charge for

QuickClick glides with or without felt: +24

Certifications

FSC® certified
EN 1022:2005, EN 16139:2013 (L1)

Recommended upholstery

Fabric group 0	Connect
Fabric group 1	Gran Linen, Remix, Capture, Bardal, Re-wool, Linara, Natural Linen, Erik
Fabric group 2	Hallingdal, Steelcut Trio, Fiord, Ruskin, Savoy, Barnum, Loop
Fabric group 3	Vidar, Sunniva, Clay, Divina Melange, SheWorks Ribbon
Fabric group 4	Sisu, Safire, Cotil, Elle
Fabric group 5	Grand Mohair, Gentle
Leather group 0	Vice
Leather group 1	Omni
Leather group 2	Primo, Trace
Leather group 3	Max
Leather group 4	Nubuck, Organic, Vegeta, Cera

Model 3237

The Spanish Dining Chair



Designed by Børge Mogensen, 1964

Chair with frame of solid wood. Seat and back in vegetable tanned saddle leather with metal buckles. Leather seat has canvas backing. Saddle straps can be tightened as the leather expands through use.

Modeldetails

0,32 m³ Packaging dimensions:
9,5 kg / 7,7 kg L: 54 cm W: 61 cm H: 99 cm

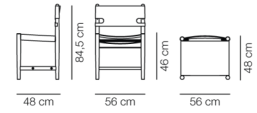

Essential Assortment

Pre-configured

Item number	Upholstery	Wood	Price
323710750502	Leather, cognac	Oak light oil	2.125
323710350500	Leather, natural	Oak soap	2.375
323710950501	Leather, black	Smoked oak, oiled	2.500

Order configuration

	Oak soap	Oak oiled	Oak light oil	Oak black lacquered	Smoked oak, oiled
Natural leather	2.375	2.510	2.510	2.510	2.885
Black leather	2.320	2.320	2.320	2.320	2.500
Cognac leather	2.320	2.320	2.125	2.320	2.670
Dark Brown leather	2.320	2.320	2.320	2.320	2.670

Extra charge for

QuickClick glides with or without felt (R3237): +24

Certifications

EN 1022:2005, EN 16139:2013 (L2)

Model 3238

The Spanish Dining Chair Armchair



Designed by Børge Mogensen, 1964

Armchair with frame of solid wood. Seat and back in vegetable tanned saddle leather with metal buckles. Leather seat has canvas backing. Saddle straps can be tightened as the leather expands through use.

Model details

0,3 m³ Packaging dimensions:
10 kg / 8,9 kg L: 53 cm W: 69 cm H: 83 cm

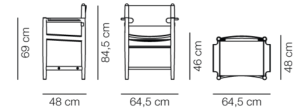

Essential Assortment

Pre-configured

Item number	Upholstery	Wood	Price
323810750502	Leather, cognac	Oak light oil	2.365
323810350500	Leather, natural	Oak soap	2.610
323810950501	Leather, black	Smoked oak, oiled	2.735

Order configuration

	Oak soap	Oak oiled	Oak light oil	Oak black lacquered	Smoked oak, oiled
Natural leather	2.610	2.720	2.720	2.720	3.290
Black leather	2.515	2.515	2.515	2.515	2.735
Cognac leather	2.515	2.515	2.365	2.515	2.895
Dark Brown leather	2.515	2.515	2.515	2.515	2.895

Extra charge for

QuickClick glides with or without felt (R3237): +24

Certifications

EN 1022:2005, EN 16139:2013 (L2)

Model P3237

The Spanish Dining Chair Accs. Leather set for 3237 / 3238



Designed by Børge Mogensen

Seat and back in vegetable tanned saddle leather with metal buckles. Leather seat has canvas backing. Saddle straps can be tightened as the leather expands through use.

Order configuration

	Natural leather	Black leather	Cognac leather	Dark Brown leather
	1.635	1.470	1.470	1.470

Model 3050

Søborg Wood base Chair Wooden seat



Designed by Børge Mogensen, 1950

Frame of solid wood, seat and back of moulded plywood. Interchangeable seat and back mounted with black metal screws. Mounted with plastic glides.

Modeldetails

0,4 m³ Packaging dimensions:
7,6 kg / 5 kg L: 58 cm W: 62 cm H: 97 cm

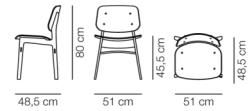

Essential Assortment

Pre-configured

Item number	Wood	Price
3050202868	Oak lacquer, FSC Mix 70%	575
3050224856	Oak black lacquer, FSC Mix 70%	575
3050162730	Walnut lacquer	700

Essential variants are delivered with plastic glides

Order configuration

	Oak lacquered	Oak oiled	Oak black lacquered	Walnut lacquered
	575	645	575	700

Extra charge for

Glides with felt: +12

Certifications

Oak is FSC® certified
EN 1022:2005, EN 16139:2013 (L2)

Model 3051

Søborg Wood base Chair Seat upholstered



Designed by Børge Mogensen, 1950

Wooden side chair with upholstered seat. Frame of solid wood, seat and back of moulded plywood. Interchangeable seat pad upholstered in HR or CMHR foam with fixed cover in fabric or leather. Interchangeable back mounted with black metal screws. Mounted with plastic glides.

Modeldetails

0,4 m³ Packaging dimensions:
8,2 kg / 5,6 kg L: 65 cm W: 60 cm H: 107 cm

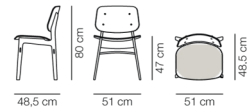

Essential Assortment

Pre-configured

Item number	Upholstery	Wood	Price
305120286800219	Hallingdal 130	Oak lacquer, FSC Mix 70%	760
305122485600219	Hallingdal 130	Oak black lacquer, FSC Mix 70%	760
305120286851301	Leather Omni 301, Black	Oak lacquer, FSC Mix 70%	780
305122485651301	Leather Omni 301, Black	Oak black lacquer, FSC Mix 70%	780
305120286850095	Leather Max 95, Cognac	Oak lacquer, FSC Mix 70%	905
305116273000219	Hallingdal 130	Walnut lacquer	915
305116273051301	Leather Omni 301, Black	Walnut lacquer	940

Essential variants are delivered with plastic glides and HR foam

Order configuration

	Oak lacquered	Oak oiled	Oak black lacquered	Walnut lacquered
Fabric group 1	740	740	740	885
Fabric group 2	760	760	760	915
Fabric group 3	790	790	790	950
Fabric group 4	825	825	825	995
Fabric group 5	870	870	870	1.045
C.O.M. fabric	740	740	740	885
Leather group 0	725	725	725	870
Leather group 1	780	780	780	940
Leather group 2	835	835	835	1.005
Leather group 3	905	905	905	1.090
Leather group 4	995	995	995	1.195
Leather group 5	1.145	1.145	1.145	1.375
C.O.M. leather	780	780	780	940

Fabric consumption: 0,6 m. Leather consumption: 0,54 m²

Extra charge for

Glides with felt: +12

Certifications

Oak is FSC® certified
EN 1022:2005, EN 16139:2013 (L2)

Recommended upholstery

Fabric group 1	Gran Linen, Linara, Bardal, Capture, Remix, Natural Linen, Re-wool, Erik
Fabric group 2	Savoy, Barnum, Steelcut Trio, Fiord, Hallingdal, Ruskin, Loop
Fabric group 3	Vidar, Clay, Sunniva, Divina Melange, SheWorks Ribbon
Fabric group 4	Sisu, Elle, Safire, Cotil
Fabric group 5	Gentle, Grand Mohair
Leather group 1	Omni
Leather group 2	Primo, Trace
Leather group 3	Max
Leather group 4	Vegeta, Nubuck, Organic, Cera

Model 3052

Søborg Wood base Chair Front upholstered



Designed by Børge Mogensen, 1950

Wooden side chair with upholstered seat and back. Frame of solid wood, seat and back of moulded plywood. Interchangeable seat pad and non-removeable back upholstered in HR or CMHR foam with fixed cover in fabric or leather. Mounted with plastic glides.

Modeldetails

0,34 m³ Packaging dimensions:
9,2 kg / 6,6 kg L: 58 cm W: 62 cm H: 97 cm

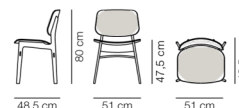

Essential Assortment

Pre-configured

Item number	Upholstery	Wood	Price
3052224856002050	Hallingdal 110	Oak black lacquer, FSC Mix 70%	895

Essential variants are delivered with plastic glides and HR foam

Order configuration

	Oak lacquered	Oak oiled	Oak black lacquered	Walnut lacquered
Fabric group 1	840	840	840	1.010
Fabric group 2	895	895	895	1.075
Fabric group 3	950	950	950	1.140
Fabric group 4	1.035	1.035	1.035	1.245
Fabric group 5	1.140	1.140	1.140	1.370
C.O.M. fabric	840	840	840	1.010
Leather group 0	845	845	845	1.015
Leather group 1	910	910	910	1.090
Leather group 2	1.015	1.015	1.015	1.215
Leather group 3	1.130	1.130	1.130	1.355
Leather group 4	1.245	1.245	1.245	1.495
Leather group 5	1.430	1.430	1.430	1.720
C.O.M. leather	910	910	910	1.090

Fabric consumption: 0,6 m. Leather consumption: 0,9 m²

Extra charge for

Glides with felt: +12

Certifications

Oak is FSC® certified
EN 1022:2005, EN 16139:2013 (L2)

Recommended upholstery

Fabric group 1	Gran Linen, Linara, Bardal, Capture, Remix, Natural Linen, Re-wool, Erik
Fabric group 2	Savoy, Barnum, Steelcut Trio, Fiord, Hallingdal, Ruskin, Loop
Fabric group 3	Vidar, Clay, Sunniva, Divina Melange, SheWorks Ribbon
Fabric group 4	Sisu, Elle, Safire, Cotil
Fabric group 5	Gentle, Grand Mohair
Leather group 1	Omni
Leather group 2	Primo, Trace
Leather group 3	Max
Leather group 4	Vegeta, Nubuck, Organic, Cera

Model 3060

Søborg Metal base Chair Wooden seat



Designed by Børge Mogensen, 1952

Plywood side chair with steel tube frame. Interchangeable seat and back mounted with black metal screws. Mounted with plastic glides.

Modeldetails

0,34 m³ Packaging dimensions:
8,6 kg / 6 kg L: 58 cm W: 62 cm H: 97 cm

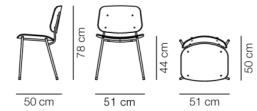

Essential Assortment

Pre-configured

Item number	Wood	Frame	Price
3060202400	Oak lacquer, FSC Mix 70%	Black	575
3060224400	Oak black lacquer, FSC Mix 70%	Black	575
3060162400	Walnut lacquer	Black	700

Essential variants are delivered with plastic glides

Order configuration

	Oak lacquered	Oak oiled	Oak black lacquered	Walnut lacquered
Black	575	620	575	700
Chrome	620	620	620	745

Other frame colours by quotation (min. 20 pcs.).

Extra charge for

Glides with felt: +12

Certifications

Oak is FSC® certified
EN 1022:2005, EN 16139:2013 (L2)

Model 3061

Søborg Metal base Chair Seat upholstered



Designed by Børge Mogensen, 1952

Plywood side chair with steel tube frame. Interchangeable seat pad upholstered in HR or CMHR foam with fixed cover in fabric or leather. Interchangeable back mounted with black metal screws. Mounted with plastic glides.

Modeldetails

0,34 m³ Packaging dimensions:
9,5 kg / 6,9 kg L: 58 cm W: 62 cm H: 97 cm

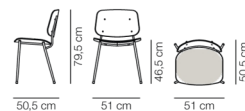

Essential Assortment

Pre-configured

Item number	Upholstery	Wood	Frame	Price
306120210000219	Hallingdal 130	Oak lacquer, FSC Mix 70%	Chrome	755
306122410000219	Hallingdal 130	Oak black lacquer, FSC Mix 70%	Chrome	755
306120240051301	Leather Omni 301, Black	Oak lacquer, FSC Mix 70%	Black	775
306122440051301	Leather Omni 301, Black	Oak black lacquer, FSC Mix 70%	Black	775
306116210000219	Hallingdal 130	Walnut lacquer	Chrome	905
306116240051301	Leather Omni 301, Black	Walnut lacquer	Black	930

Essential variants are delivered with plastic glides and HR foam

Order configuration

Frame: Chrome or black.

	Oak lacquered	Oak oiled	Oak black lacquered	Walnut lacquered
Fabric group 1	730	730	730	880
Fabric group 2	755	755	755	905
Fabric group 3	785	785	785	940
Fabric group 4	820	820	820	985
Fabric group 5	860	860	860	1.030
C.O.M. fabric	730	730	730	880
Leather group 0	720	720	720	865
Leather group 1	775	775	775	930
Leather group 2	825	825	825	995
Leather group 3	900	900	900	1.080
Leather group 4	990	990	990	1.185
Leather group 5	1.135	1.135	1.135	1.365
C.O.M. leather	775	775	775	930

Fabric consumption: 0,6 m. Leather consumption: 0,54 m²

Other frame colours by quotation (min. 20 pcs.).

Extra charge for

Glides with felt: +12

Certifications

Oak is FSC® certified

EN 1022:2005, EN 16139:2013 (L2)

Recommended upholstery

Fabric group 1	Natural Linen, Re-wool, Remix, Bardal, Capture, Linara, Erik, Gran Linen
Fabric group 2	Steelcut Trio, Fiord, Savoy, Hallingdal, Ruskin, Barnum, Loop
Fabric group 3	Sunniva, Divina Melange, Vidar, Clay, SheWorks Ribbon
Fabric group 4	Elle, Safire, Sisu, Cotil
Fabric group 5	Grand Mohair, Gentle
Leather group 0	Vice
Leather group 1	Omni
Leather group 2	Primo, Trace
Leather group 3	Max
Leather group 4	Nubuck, Organic, Cera, Vegeta

Model 3062

Søborg Metal base Chair Front upholstered



Designed by Børge Mogensen, 1952

Plywood side chair with steel tube frame. Interchangeable seat pad and non-removable back upholstered in HR or CMHR foam with fixed cover in fabric or leather. Mounted with plastic glides.

Modeldetails

0,34 m³ Packaging dimensions:
10,2 kg / 7,6 kg L: 58 cm W: 62 cm H: 97 cm

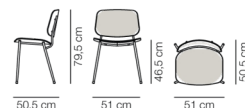

Essential Assortment

Pre-configured

Item number	Upholstery	Wood	Frame	Price
306220210000219056	Hallingdal 130	Oak lacquer, FSC Mix 70%	Chrome	885
306222410000219056	Hallingdal 130	Oak black lacquer, FSC Mix 70%	Chrome	885
306220240051301056	Leather Omni 301, Black	Oak lacquer, FSC Mix 70%	Black	900
306222440051301056	Leather Omni 301, Black	Oak black lacquer, FSC Mix 70%	Black	900

Essential variants are delivered with plastic glides and HR foam

Order configuration

Frame: Chrome or black.

	Oak lacquered	Oak oiled	Oak black lacquered	Walnut lacquered
Fabric group 1	830	830	830	995
Fabric group 2	885	885	885	1.060
Fabric group 3	940	940	940	1.125
Fabric group 4	1.025	1.025	1.025	1.230
Fabric group 5	1.125	1.125	1.125	1.350
C.O.M. fabric	830	830	830	995
Leather group 0	835	835	835	1.000
Leather group 1	900	900	900	1.075
Leather group 2	1.000	1.000	1.000	1.200
Leather group 3	1.115	1.115	1.115	1.340
Leather group 4	1.230	1.230	1.230	1.475
Leather group 5	1.410	1.410	1.410	1.695
C.O.M. leather	900	900	900	1.075

Fabric consumption: 0,6 m. Leather consumption: 0,9 m²

Other frame colours by quotation (min. 20 pcs.).

Extra charge for

Glides with felt: +12

Certifications

Oak is FSC® certified

EN 1022:2005, EN 16139:2013 (L2)

Recommended upholstery

Fabric group 1	Natural Linen, Re-wool, Remix, Bardal, Capture, Linara, Erik, Gran Linen
Fabric group 2	Steelcut Trio, Fiord, Savoy, Hallingdal, Ruskin, Barnum, Loop
Fabric group 3	Sunniva, Divina Melange, Vidar, Clay, SheWorks Ribbon
Fabric group 4	Elle, Safire, Sisu, Cotil
Fabric group 5	Grand Mohair, Gentle
Leather group 0	Vice
Leather group 1	Omni
Leather group 2	Primo, Trace
Leather group 3	Max
Leather group 4	Nubuck, Organic, Cera, Vegeta

Model 3090

Søborg Accessories

Chair suspensions

Designed by Fredericia Furniture

Chair suspensions in black powder coated steel. Can only be used on tables without an apron at the edge. Only one template is needed for mounting all chair suspensions.

Order configuration

	No template	Template enclosed
Black	70	165

Model 1731



Spine Wood Barstool Front upholstered

Designed by Space Copenhagen, 2011

Barstool with legs of solid wood with powder coated aluminum stretcher. Seat shell of plywood. Front side of seat shell is upholstered with HR or CMHR foam and covered in fabric or leather, finished with piping. Please specify counter- or bar height.

Modeldetails

0,34 m³ Packaging dimensions:
13,3 kg / 10,2 kg L: 57 cm W: 53 cm H: 109/120 cm

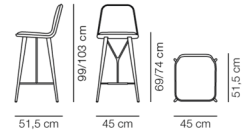

Essential Assortment

Pre-configured

Item number	Upholstery	Wood	Seat height	Price
1731756500110400	Leather Vice 11, Black	Ash, black lacquer - black metal, FSC MIX 70%	74 cm	1.290
1731756586800400	Leather Trace 8680, Heritage brown	Ash, black lacquer - black metal, FSC MIX 70%	74 cm	1.460
1731757002070400	Hallingdal 200	Oak lacquer - black metal, FSC Mix 70%	74 cm	1.745
1731755511120400	Leather Omni 112, Warm grey	Smoked oak stained lacq. -black metal, FSC Mix 70%	74 cm	1.925

Essential variants only delivered with HR foam

Order configuration

Bar or counter height.

	Oak lacquered	Black ash	Smoked oak stained, lacquered
Fabric group 0	1.535	1.180	1.770
Fabric group 1	1.710	1.350	1.880
Fabric group 2	1.745	1.380	1.920
Fabric group 3	1.795	1.435	1.975
Fabric group 4	1.885	1.525	2.075
Fabric group 5	2.000	1.620	2.200
C.O.M. fabric	1.710	1.350	1.880
Leather group 0	1.625	1.290	1.790
Leather group 1	1.750	1.390	1.925
Leather group 2	1.820	1.460	2.005
Leather group 3	1.885	1.525	2.075
Leather group 4	2.075	1.680	2.285
Leather group 5	2.390	1.930	2.625
C.O.M. leather	1.750	1.390	1.925

Fabric consumption: 0,6 m. Leather consumption: 0,96 m²

Metal parts: Black.

Extra Charge for

QuickClick glides with or without felt: +12

Certifications

FSC® certified

EU Ecolabel variants: HR foam and upholstery in Omni leather or Connect, Remix, Re-wool, Steelcut Quartet, Vidar, Tonus fabric

EN 1022:2005, EN 16139:2013 (L1)

Recommended upholstery

Fabric group 0	Connect
Fabric group 1	Gran Linen, Linara, Bardal, Capture, Remix, Re-wool, Natural Linen, Erik
Fabric group 2	Savoy, Barnum, Steelcut Trio, Fiord, Hallingdal, Ruskin, Loop, Steelcut Quartet
Fabric group 3	Vidar, Clay, Sunniva, Divina Melange, Tonus
Fabric group 4	Sisu, Safire, Cotil, Elle
Fabric group 5	Gentle, Grand Mohair
Leather group 0	Vice
Leather group 1	Omni
Leather group 2	Primo, Trace
Leather group 3	Max
Leather group 4	Nubuck, Organic, Vegeta, Cera

Model 1736

Spine Wood Stool Seat upholstered



Designed by Space Copenhagen, 2014

Legs of solid wood with powder coated aluminum stretcher. Seat shell of plywood. Seat is upholstered with HR or CMHR foam and covered in fabric or leather. Please specify counter or bar height.

Modeldetails

0,14 m³ Packaging dimensions:
6,5 kg / 5,2 kg L: 39 cm W: 46 cm H: 72/78 cm



Essential Assortment

Pre-configured

Item number	Upholstery	Wood	Seat height	Price
1736756500110400	Leather Vice 11, Black	Ash, black lacquer - black metal, FSC MIX 70%	74 cm	795
1736756586800400	Leather Trace 8680, Heritage brown	Ash, black lacquer - black metal, FSC MIX 70%	74 cm	875
1736757002070400	Hallingdal 200	Oak lacquer - black metal, FSC Mix 70%	74 cm	1.085
1736755511120400	Leather Omni 112, Warm grey	Smoked oak stained lacq. -black metal, FSC Mix 70%	74 cm	1.195

Essential variants only delivered with HR foam

Order configuration

Bar or counter height.

	Oak lacquered	Black ash	Smoked oak stained, lacquered
Fabric group 0	945	705	1.060
Fabric group 1	1.070	840	1.180
Fabric group 2	1.085	855	1.195
Fabric group 3	1.105	875	1.215
Fabric group 4	1.125	895	1.240
Fabric group 5	1.155	925	1.270
C.O.M. fabric	1.070	840	1.180
Leather group 0	1.010	795	1.110
Leather group 1	1.085	855	1.195
Leather group 2	1.105	875	1.215
Leather group 3	1.130	900	1.245
Leather group 4	1.245	990	1.365
Leather group 5	1.430	1.135	1.575
C.O.M. leather	1.085	855	1.195

Fabric consumption: 0,57 m. Leather consumption: 0,44 m²

Metal parts: Black.

Extra Charge for

QuickClick glides with or without felt: +12

Certifications

FSC® certified

EU Ecolabel variants: HR foam and upholstery in Omni leather or Connect, Remix, Re-wool, Steelcut Quartet, Vidar, Tonus fabric

EN 1022:2005, EN 16139:2013 (L1)

Recommended upholstery

Fabric group 0	Connect
Fabric group 1	Gran Linen, Linara, Bardal, Capture, Remix, Re-wool, Natural Linen, Erik
Fabric group 2	Savoy, Barnum, Steelcut Trio, Fiord, Hallingdal, Ruskin, Loop, Steelcut Quartet
Fabric group 3	Vidar, Clay, Sunniva, Divina Melange, Tonus
Fabric group 4	Sisu, Safire, Cotil, Elle
Fabric group 5	Gentle, Grand Mohair
Leather group 0	Vice
Leather group 1	Omni
Leather group 2	Primo, Trace
Leather group 3	Max
Leather group 4	Nubuck, Organic, Vegeta, Cera

Model 1777



Swoon Dining Armchair

Wood base

Designed by Space Copenhagen, 2019

Fully upholstered chair with solid wood legs mounted with metal thread. Inner shell in moulded high pressure polyurethane foam, reinforced with a steel frame. Removable seat cushion with HR or CMHR foam with removable cover. Available in fabric or leather. Mounted with plastic glides. Felt glides available.

Modeldetails

0,43 m³ Packaging dimensions:
15 kg / L: 69 cm W: 70 cm H: 90 cm
10,9 kg

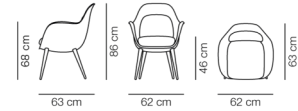

Essential Assortment

Pre-configured

Item number	Upholstery	Legs	Price
17770772200005202005	Sunniva 242	Oak lacquer, FSC Mix 70%	1.815
17770773900005162005	Sunniva 717	Walnut lacquer	1.815
17770774500005224005	Sunniva 192	Oak black lacquer FSC Mix 70%	1.815

Essential variants are delivered with plastic glides and HR foam

Order configuration

Legs: Walnut lacquered, oak lacquered, oak oiled, smoked oak stained lacquered or oak black lacquered.

Fabric group 0	1.405
Fabric group 1	1.510
Fabric group 2	1.670
Fabric group 3	1.815
Fabric group 4	2.100
Fabric group 5	2.460
C.O.M. fabric	1.510
Leather group 1	1.745
Leather group 2	2.005
Leather group 3	2.235
Leather group 4	2.475
Leather group 5	2.850
C.O.M. leather	1.745

Fabric consumption: 3 m. Leather consumption: 5 m²

Different fabrics on corpus and cushion upon request.

Certifications

Oak is FSC® certified

EN 1022:2005, EN 16139:2013 (L2), ANSI/BIFMA X7.1/M7.1/e3-2019 VOC test (tested with HR foam and EU Ecolabel fabric)

Recommended upholstery

Fabric group 0	Connect
Fabric group 1	Bardal, Capture, Remix, Re-wool, Linara, Erik
Fabric group 2	Barnum, Steelcut Trio, Ruskin, Savoy, Fiord, Hallingdal, Loop
Fabric group 3	Sunniva, Divina Melange, Vidar, Clay
Fabric group 4	Safire, Sisu, Elle
Fabric group 5	Grand Mohair, Gentle
Leather group 1	Omni
Leather group 2	Primo, Trace
Leather group 3	Max
Leather group 4	Vegeta, Nubuck, Organic

Model 1779

Swoon Dining Armchair Swivel base



Designed by Space Copenhagen, 2019

Fully upholstered dining chair with aluminum swivel base. Inner shell in moulded polyurethane foam, reinforced with a steel frame. Removable seat cushion with HR or CMHR foam with removable cover. Available in fabric or leather. Mounted with reversible plastic glides which can be changed to felt when reversed.

Modeldetails

0,49 m³ Packaging dimensions:
22 kg / L: 70 cm W: 70 cm H: 101 cm
16 kg

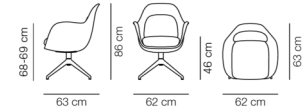

Essential Assortment

Pre-configured

Item number	Upholstery	Frame	Price
17790772200005905040	Sunniva 242	Swivel base polished aluminium	2.020
17790773900005451040	Sunniva 717	Swivel base black	2.020
17790774500005451040	Sunniva 192	Swivel base black	2.020

Essential variants are delivered with plastic glides and HR foam

Order configuration

Frame: Polished aluminium or black.

Fabric group 0	1.595
Fabric group 1	1.715
Fabric group 2	1.875
Fabric group 3	2.020
Fabric group 4	2.305
Fabric group 5	2.670
C.O.M. fabric	1.715
Leather group 1	1.950
Leather group 2	2.210
Leather group 3	2.440
Leather group 4	2.680
Leather group 5	3.085
C.O.M. leather	1.950

Fabric consumption: 3 m. Leather consumption: 5 m²

Different fabrics on corpus and cushion upon request.

Extra charge for

Castors, chrome or black: +24

Certifications

EN 1022:2005, EN 16139:2013 (L2), ANSI/BIFMA X7.1/M7.1/e3-2019 VOC test (tested with HR foam and EU Ecolabel fabric)

Recommended upholstery

Fabric group 0	Connect
Fabric group 1	Bardal, Capture, Remix, Re-wool, Linara, Erik
Fabric group 2	Barnum, Steelcut Trio, Ruskin, Savoy, Fiord, Hallingdal, Loop
Fabric group 3	Sunniva, Divina Melange, Vidar, Clay
Fabric group 4	Safire, Sisu, Elle
Fabric group 5	Grand Mohair, Gentle
Leather group 1	Omni
Leather group 2	Primo, Trace
Leather group 3	Max
Leather group 4	Vegeta, Nubuck, Organic

Model 3398

Trinidad Chair Wooden seat



Designed by Nanna Ditzel, 1993

Stacking chair. Frame of steel tube, back of moulded plywood with CNC-milled cut-outs. Seat and back mounted with rivets. Mounted with interchangeable plastic glides.

Modeldetails

0,4 m³ Packaging dimensions:
5,8 kg / 4,15 kg L: 72 cm W: 54 cm H: 103 cm



Essential Assortment

Pre-configured

Item number	Wood	Frame	Price
339821200000450016	Beech, lacquer, FSC Mix 70%	Black	480
339827500000100016	Beech nordic blue, FSC Mix 70%	Chrome	480
339828000000100016	Beech khaki green, FSC Mix 70%	Chrome	480
339820200000100016	Oak lacquer, FSC Mix 70%	Chrome	540
339822300000100016	Black ash, FSC Mix 70%	Chrome	540
339822600000450016	Walnut lacquer, FSC Mix 70%	Black	540
339814400000100016	Oregon pine aged lacquer	Chrome	540

Essential variants are delivered with plastic glides

Order configuration

	Black ash	Beech lacquered / Beech coloured lacquer	Oak lacquered / Oak oiled / Oregon pine aged lacquer	Walnut lacquered	Smoked oak stained, lacquered
Black	565	480	565	540	565
Flint	565	495	565	565	565
Chrome	540	495	565	565	565

Beech coloured lacquer: Nordic blue, Khaki green

Stackable: 8 pcs.

Extra charge for

Glides with felt: +12
Frame brushed stainless steel - each: +180
(price added to chrome order configuration price)

Certifications

FSC® certified
EU Ecolabel variants: Oak, walnut, ash, beech frame in chrome, black or flint
EN 1022:2005, EN 16139:2013 (L2)

Model 3396

Trinidad Chair Seat upholstered



Designed by Nanna Ditzel, 1993

Wood chair with frame of steel tube and upholstered seat. Frame of steel tube, back of moulded plywood with CNC-milled cut-outs. Interchangeable seat pad upholstered in HR or CMHR foam with fixed cover in fabric or leather. Seat and back mounted with rivets. Mounted with interchangeable plastic glides.

Modeldetails

0,4 m³ Packaging dimensions:
5,9 kg / 5 kg L: 72 cm W: 54 cm H: 103 cm



Essential Assortment

Pre-configured

Item number	Upholstery	Wood	Frame	Price
339621251301450016	Leather Omni 301, Black	Beech, lacquer, FSC Mix 70%	Black	630
339620251301100016	Leather Omni 301, Black	Oak lacquer, FSC Mix 70%	Chrome	700
339622351301100016	Leather Omni 301, Black	Black ash, FSC Mix 70%	Chrome	700
339622651301450016	Leather Omni 301, Black	Walnut lacquer, FSC Mix 70%	Black	700

Essential variants are delivered with plastic glides and HR foam

Order configuration

Frame: Chrome, black or flint.

	Black ash	Beech lacquered / Beech coloured lacquer	Oak lacquered / Oak oiled / Oregon pine aged lacquer	Walnut lacquered	Smoked oak stained, lacquered
Fabric group 0	630	565	630	630	630
Fabric group 1	675	610	675	675	675
Fabric group 2	685	620	685	685	685
Fabric group 3	690	625	690	690	690
Fabric group 4	700	635	700	700	700
Fabric group 5	735	670	735	735	735
C.O.M. fabric	675	610	675	675	675
Leather group 0	650	585	650	650	650
Leather group 1	700	630	700	700	700
Leather group 2	745	680	745	745	745
Leather group 3	780	710	780	780	780
Leather group 4	815	750	815	815	815
Leather group 5	940	860	940	940	940
C.O.M. leather	700	630	700	700	700

Fabric consumption: 0,5 m. Leather consumption: 0,44 m²

Beech coloured lacquer: Nordic blue, Khaki green.

Extra charge for

Glides with felt: +12
Frame brushed stainless steel - each: +180

Certifications

FSC® certified

EU Ecolabel variants: Oak, walnut, ash, beech frame in chrome, black or flint with HR foam and upholstery in Omni leather or Connect, Re-wool, Remix, Hallingdal fabric EN 1022:2005, EN 16139:2013 (L2)

Recommended upholstery

Fabric group 0	Connect
Fabric group 1	Gran Linen, Erik, Remix, Capture, Bardal, Re-wool, Linara, Natural Linen
Fabric group 2	Hallingdal, Barnum, Loop, Steelcut Trio, Fiord, Ruskin, Savoy
Fabric group 3	Divina Melange, Vidar, Sunniva, Clay, SheWorks Ribbon
Fabric group 4	Cotil, Elle, Sisu, Safire
Fabric group 5	Grand Mohair, Gentle
Leather group 0	Vice
Leather group 1	Omni
Leather group 2	Primo, Trace
Leather group 3	Max
Leather group 4	Nubuck, Organic, Vegeta, Cera

Model 3399

Trinidad Armchair Wooden seat



Designed by Nanna Ditzel, 1993

Chair with armrests, non stackable. Frame of steel tube, seat and back of moulded plywood with CNC-milled cut-outs. Seat and back mounted with rivets. Mounted with interchangeable plastic glides.

Modeldetails

0,46 m³ Packaging dimensions:
7,8 kg / 5,8 kg L: 64 cm W: 71 cm H: 100 cm

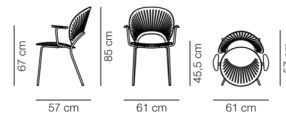

Essential Assortment

Pre-configured

Item number	Wood	Frame	Price
339921200000450016	Beech, lacquer, FSC Mix 70%	Black	720
339920200000100016	Oak lacquer, FSC Mix 70%	Chrome	780
339922300000100016	Black ash, FSC Mix 70%	Chrome	780
339922600000450016	Walnut lacquer, FSC Mix 70%	Black	780

Essential variants are delivered with plastic glides

Order configuration

	Black ash	Beech lacquered / Beech coloured lacquer	Oak lacquered / Oak oiled / Oregon pine aged lacquer	Walnut lacquered	Smoked oak stained, lacquered
Black	825	760	825	780	825
Flint	825	760	825	825	825
Chrome	780	760	825	825	825

Beech coloured lacquer: Nordic blue, Khaki green.

Extra charge for

Glides with felt: +12

Certifications

FSC® certified

EU Ecolabel variants: Oak, walnut, ash, beech frame in chrome, black or flint

EN 1022:2005, EN 16139:2013 (L2)

Model 3397

Trinidad Armchair Seat upholstered



Designed by Nanna Ditzel, 1993

Chair with armrests and upholstered seat, non-stackable. Frame of steel tube, back, seat and armrests of moulded plywood. Back with CNC-milled cut-outs. Non-removable seat pad upholstered in HR or CMHR foam, covered in fabric or leather. Seat and back mounted with rivets. Mounted with interchangeable plastic glides.

Modeldetails

0,46 m³ Packaging dimensions:
8 kg / 6 kg L: 64 cm W: 71 cm H: 100 cm

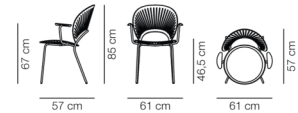

Essential Assortment

Pre-configured

Item number	Upholstery	Wood	Frame	Price
339721251301450016	Leather Omni 301, Black	Beech, lacquer, FSC Mix 70%	Black	880
339720251301100016	Leather Omni 301, Black	Oak lacquer, FSC Mix 70%	Chrome	965
339722351301100016	Leather Omni 301, Black	Black ash, FSC Mix 70%	Chrome	965
339722651301450016	Leather Omni 301, Black	Walnut lacquer, FSC Mix 70%	Black	965

Essential variants are delivered with plastic glides and HR foam

Order configuration

Frame: Chrome, black or flint.

	Black ash	Beech lacquered / Beech coloured lacquered	Oak lacquered / Oak oiled / Oregon pine aged lacquer	Walnut lacquered	Smoked oak stained, lacquered
Fabric group 0	875	810	875	875	875
Fabric group 1	945	870	945	945	945
Fabric group 2	950	880	950	950	950
Fabric group 3	960	890	960	960	960
Fabric group 4	965	900	965	965	965
Fabric group 5	1.015	945	1.015	1.015	1.015
C.O.M. fabric	945	870	945	945	945
Leather group 0	900	820	900	900	900
Leather group 1	965	880	965	965	965
Leather group 2	1.015	930	1.015	1.015	1.015
Leather group 3	1.050	980	1.050	1.050	1.050
Leather group 4	1.100	1.030	1.100	1.100	1.100
Leather group 5	1.270	1.185	1.270	1.270	1.270
C.O.M. leather	965	880	965	965	965

Fabric consumption: 0,5 m. Leather consumption: 0,44 m²

Beech coloured lacquered: Nordic blue, Khaki green.

Extra charge for

Glides with felt: +12

Certifications

FSC® certified

EU Ecolabel variants: Oak, walnut, ash, beech frame in chrome, black or flint with HR foam and upholstery in Omni leather or Connect, Re-wool, Remix, Hallingdal fabric EN 1022:2005, EN 16139:2013 (L2)

Recommended upholstery

Fabric group 0	Connect
Fabric group 1	Gran Linen, Remix, Capture, Bardal, Re-wool, Linara, Natural Linen, Erik
Fabric group 2	Hallingdal, Barnum, Loop, Steelcut Trio, Fiord, Ruskin, Savoy
Fabric group 3	Divina Melange, Vidar, Sunniva, Clay, SheWorks Ribbon
Fabric group 4	Sisu, Safire, Elle, Cotil
Fabric group 5	Grand Mohair, Gentle
Leather group 0	Vice
Leather group 1	Omni
Leather group 2	Primo, Trace
Leather group 3	Max
Leather group 4	Nubuck, Organic, Vegeta, Cera

Model 3400



Trinidad Barstool Wooden seat

Designed by Nanna Ditzel, 1998

Barstool with steel tube frame. Seat and back of moulded plywood with CNC-milled cut-outs, mounted with rivets. Mounted with interchangeable plastic glides.

Modeldetails

0,33 m³ Packaging dimensions:
9 kg / 5,6 kg L: 57 cm W: 52 cm H: 114 cm

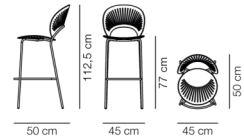

Essential Assortment

Pre-configured

Item number	Wood	Frame	Price
3400223000004501600	Black ash, FSC Mix 70%	Black, smooth	925

Essential variants are delivered with plastic glides

Order configuration

	Black ash	Oak lacquered	Oak oiled
Black	925	925	925
Flint	925	925	925
Chrome	925	925	925

Longer lead times may occur - Please contact Customer Care.

Extra charge for

Glides with felt: +12

Certifications

FSC® certified

Model 3401



Trinidad Barstool Seat upholstered

Designed by Nanna Ditzel, 1998

Barstool with upholstered seat, steel tube frame and back of moulded plywood, with CNC-milled cut-outs. Non-removable seat pad upholstered in HR or CMHR foam, covered in fabric or leather. Seat and back mounted with rivets. Mounted with interchangeable plastic glides.

Modeldetails

0,33 m³ Packaging dimensions:
10 kg / 6,6 kg L: 57 cm W: 52 cm H: 114 cm

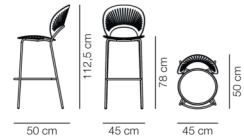

Essential Assortment

Pre-configured

Item number	Upholstery	Wood	Frame	Price
34012235008845001600	Leather Primo 88, Black	Black ash, FSC Mix 70%	Black, smooth	1.145

Essential variants are delivered with plastic glides and HR foam

Order configuration

Frame: Chrome, black or flint.

	Black ash	Oak lacquered	Oak oiled
Fabric group 0	920	920	900
Fabric group 1	990	990	970
Fabric group 2	995	995	975
Fabric group 3	1.005	1.005	985
Fabric group 4	1.015	1.015	995
Fabric group 5	1.065	1.065	1.045
C.O.M. fabric	990	990	970
Leather group 0	1.020	1.020	1.005
Leather group 1	1.100	1.100	1.080
Leather group 2	1.145	1.145	1.130
Leather group 3	1.175	1.175	1.160
Leather group 4	1.235	1.235	1.220
Leather group 5	1.420	1.420	1.400
C.O.M. leather	1.100	1.100	1.080

Fabric consumption: 0,5 m. Leather consumption: 0,44 m²

Longer lead times may occur - Please contact Customer Care.

Extra charge for

Glides with felt: +12

Certifications

FSC® certified

Recommended upholstery

Fabric group 0	Connect
Fabric group 1	Linara, Capture, Remix, Natural Linen, Re-wool, Bardal, Erik, Gran Linen
Fabric group 2	Savoy, Barnum, Steelcut Trio, Fiord, Hallingdal, Ruskin, Loop
Fabric group 3	Clay, Sunniva, Divina Melange, Vidar, SheWorks Ribbon
Fabric group 4	Sisu, Safire, Elle, Cotil
Fabric group 5	Grand Mohair, Gentle
Leather group 0	Vice
Leather group 1	Omni
Leather group 2	Primo, Trace
Leather group 3	Max
Leather group 4	Vegeta, Cera, Nubuck, Organic

**Model
3288**

Trinidad Accessories
Coupling device

Designed by Fredericia Furniture

Black coupling device in plastic for Trinidad Chair.

Modeldetails

△ 0,1 kg /
0,08 kg

Order configuration

For model 3396
and 3398

15

Model 8101

Trinidad Accessories Transport trolley

Designed by Fredericia Furniture

Transport trolley for stackable Trinidad chair. Black powder coated steel.

Modeldetails

0,49 m³ Packaging dimensions:
15 kg / L: 69 cm W: 51 cm H: 140 cm
9 kg

Order configuration

For 2 x 8 chairs

Black	860
-------	-----

Model 8102

Trinidad Accessories Chair suspensions

Modeldetails

⚖ 0,5 kg /
0,5 kg

Designed by Fredericia Furniture

Chair suspensions in black powder coated steel. Can only be used on tables without an apron at the edge. Only one template is needed for mounting all chair suspensions.

Order configuration

	No template	Template enclosed
Black	85	200



Fredericia Refurbishment Trinidad Chair

Fredericia offers a refurbishment programme to extend the life of Trinidad Chairs. This program is a circular business model that benefits all stakeholders.

The customer delivers used chairs and receives refurbished chairs ready to use.

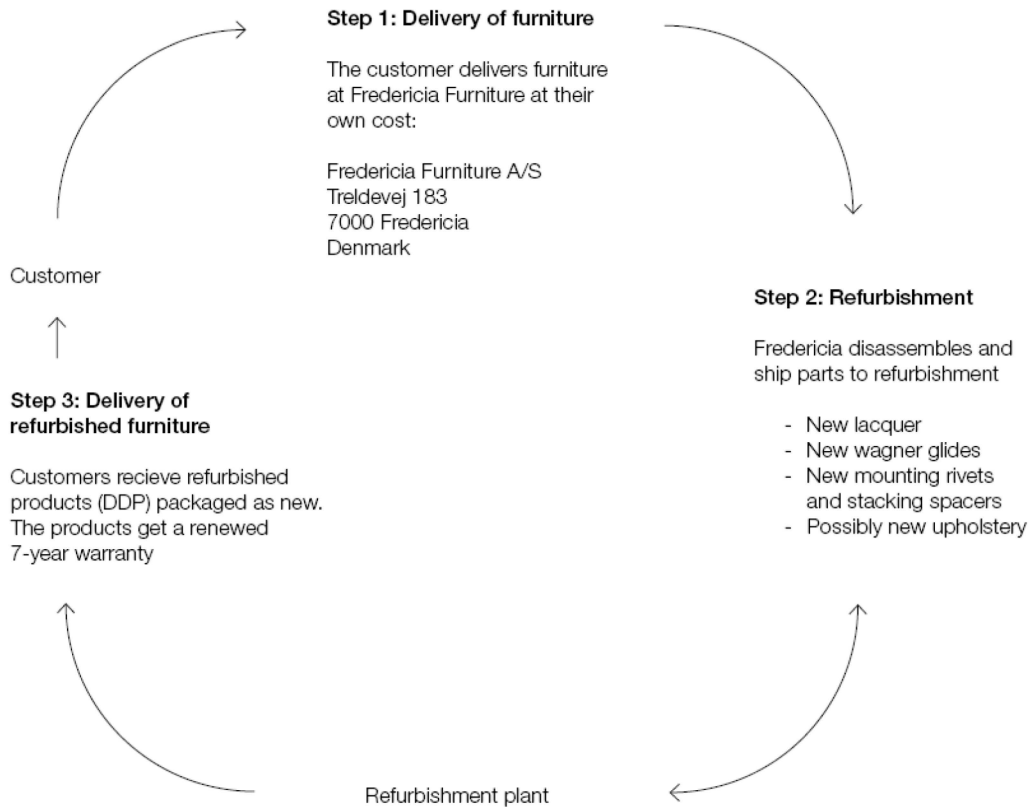

-
- Models which can be refurbished: 3298/3398 Trinidad Chair, 3296/3396 Seat upholstered
 - Minimum quantity: 20 pcs.
 - Refurbished Trinidad chairs from Fredericia come with a renewed 7-year warranty.
 - For more information please contact Fredericia Customer Care: customerservice@fredericia.com

Model 5102

ND102 Trisse Stool Ø32 cm



Designed by Nanna Ditzel, 1962

Stool in solid wood. Top, column and base are joined with steel rod.

Modeldetails

0,04 m³ Packaging dimensions:
3,8 kg / L: 35 cm W: 35 cm H: 30 cm
2,3 kg

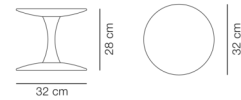

Essential Assortment

Pre-configured

Item number	Wood	Price
510224020500	Oak oil, FSC Mix 70%	405

Order configuration

	Oak soap	Oak oiled	Oak light oil	Smoked oak, oiled	Oak clear lacquered	Oak black lacquered
	405	405	405	510	450	450

Certifications

FSC® certified
EN 16139:2025 (L1), EN 1022:2023

Model 5105

ND105 Trisse Stool Ø40 cm



Designed by Nanna Ditzel, 1962

Stool in solid wood. Top, column and base are joined with steel rod. Mounted with felt glides.

Modeldetails

0,09 m³ Packaging dimensions:
6,2 kg / 4,4 kg L: 43 cm W: 43 cm H: 48 cm

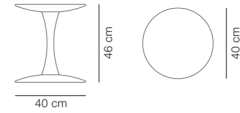

Essential Assortment

Pre-configured

Item number	Wood	Price
510530020579	Oak oil, FSC Mix 70%	520

Order configuration

	Oak soap	Oak oiled	Oak light oil	Smoked oak, oiled	Oak clear lacquered	Oak black lacquered
	520	520	520	765	565	565

Certifications

FSC® certified
EN 16139:2025 (L1), EN 1022:2023

Lounge Chairs

Model 6540

A-Chair Wood base



Designed by Jens Risom, 1961

Fully upholstered lounge chair with separate seat cushion. Inner frame of wood, upholstered in HR or CMHR foam, covered in fabric or leather. Fixed legs of solid wood. Removable seat cushion has a foam core in feather wrap. Cover on seat cushion is removable. External cover is non-removable.

Modeldetails

0,65 m³ Packaging dimensions:
28 kg / 20 kg L: 90 cm W: 80 cm H: 90 cm

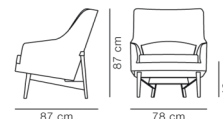

Essential Assortment

Pre-configured

Item number	Upholstery	Wood	Price
654019311020200	Re-Wool 128	Oak lacquer, FSC Mix 70%	3.200
654019300016200	Re-Wool 198	Walnut lacquer	3.530
654001671016200	Loop 33	Walnut lacquer	3.785

Essential variants only delivered with HR foam

Order configuration

	Oak lacquered	Oak oiled	Oak black lacquered	Walnut lacquered
Fabric group 1	3.200	3.310	3.200	3.530
Fabric group 2	3.475	3.585	3.475	3.785
Fabric group 3	3.725	3.830	3.725	4.015
Fabric group 4	4.205	4.315	4.205	4.470
Fabric group 5	4.830	4.935	4.830	5.050
C.O.M. fabric	3.200	3.310	3.200	3.530
Leather group 1	4.170	4.275	4.170	4.435
Leather group 2	4.870	4.980	4.870	5.090
Leather group 3	5.480	5.590	5.480	5.665
Leather group 4	6.125	6.235	6.125	6.265
C.O.M. leather	4.170	4.275	4.170	4.435

Fabric consumption: 3,1 m. Leather consumption: 5,8 m²

Extra charge for

QuickClick glides with or without felt: +12

Certifications

Oak is FSC® certified
EN 1022:2005, EN 16139:2013 (L2)

Recommended upholstery

Fabric group 1	Gran Linen, Natural Linen, Erik, Remix, Capture, Bardal, Re-wool, Linara
Fabric group 2	Hallingdal, Barnum, Loop, Steelcut Trio, Fiord, Ruskin
Fabric group 3	Divina Melange, Vidar, Sunniva, Clay
Fabric group 4	Elle, Sisu, Safire
Fabric group 5	Gentle, Grand Mohair
Leather group 1	Omni
Leather group 2	Trace
Leather group 3	Max
Leather group 4	Organic, Vegeta, Cera

Model 6542

A-Chair Metal base



Designed by Jens Risom, 1961

Fully upholstered lounge chair with separate seat cushion. Inner frame of wood, upholstered in HR or CMHR foam, covered in fabric or leather. Fixed legs of chromed or powder coated steel tube frame. Removable seat cushion has foam core in feather wrap. Cover on seat cushion is removable. External cover is non-removable. Mounted with plastic glides.

Modeldetails

0,65 m³ Packaging dimensions:
29 kg / 21 kg L: 90 cm W: 80 cm H: 90 cm

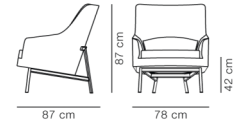

Essential Assortment

Pre-configured

Item number	Upholstery	Frame	Price
654219300040012	Re-Wool 198	Black	3.200
654219311040012	Re-Wool 128	Black	3.200
654201671040012	Loop 33	Black	3.475

Essential variants only delivered with HR foam

Order configuration

Frame: Black or matt chrome.

Fabric group 1	3.200
Fabric group 2	3.475
Fabric group 3	3.725
Fabric group 4	4.205
Fabric group 5	4.830
C.O.M. fabric	3.200
Leather group 1	4.170
Leather group 2	4.870
Leather group 3	5.480
Leather group 4	6.125
C.O.M. leather	4.170

Fabric consumption: 3,1 m. Leather consumption: 5,8 m²

Extra charge for

QuickClick glides with felt: +12

Certifications

EN 1022:2005, EN 16139:2013 (L2)

Recommended upholstery

Fabric group 1	Gran Linen, Natural Linen, Erik, Remix, Capture, Bardal, Re-wool, Linara
Fabric group 2	Hallingdal, Barnum, Loop, Steelcut Trio, Flord, Ruskin
Fabric group 3	Divina Melange, Vidar, Sunniva, Clay
Fabric group 4	Elle, Sisu, Safire
Fabric group 5	Gentle, Grand Mohair
Leather group 1	Omni
Leather group 2	Trace
Leather group 3	Max
Leather group 4	Organic, Vegeta, Cera

Model 2600

Bench for Two



Designed by Nanna Ditzel, 1989

Bench with a solid wood frame of beech from Denmark. Backrest in aircraft-grade beech plywood from Finland with a top veneer of maple. Veneer seat with a top veneer of maple. Seat and back is made with a digital print.

Modeldetails

1,36 m³ Packaging dimensions:
27 kg / 17 kg L: 160 cm W: 85 cm H: 100 cm

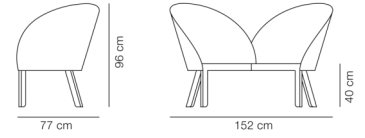

Order configuration

Only sold in sets with table

Maple veneer with print, black with red dot	Maple veneer with print, yellow with black dot	Maple veneer with print, red with black dot
7.000	7.000	7.000

Model 2601

Bench for Two Table for Bench for Two



Designed by Nanna Ditzel, 1989

Side Table with a solid wood frame of beech from Denmark. Veneer table top with a top veneer of maple which is made with a digital print.

Modeldetails

0,22 m³ Packaging dimensions:
9 kg / 6 kg L: 70 cm W: 70 cm H: 45 cm

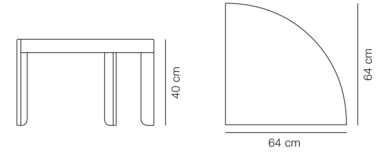

Order configuration

Only sold in sets with bench

Maple veneer with print, black with red dot	Maple veneer with print, yellow with black dot	Maple veneer with print, red with black dot
1.735	1.735	1.735

Model 2021

Canvas 21 Chair



Designed by Børge Mogensen, 1968

Lounge chair of solid wood and canvas. Fittings in solid brass. Interchangeable seat, back and armrests made of 100% linen canvas.

Modeldetails

0,327 m³ Packaging dimensions:
9,5 kg / 7,5 kg L: 62 cm W: 66 cm H: 81 cm

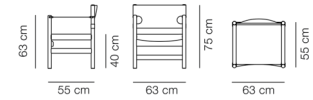

Essential Assortment

Pre-configured

Item number	Seat and back	Wood	Price
20212032000000	Natural canvas	Oak soap, FSC Mix 70%	1.445
20212062000000	Natural canvas	Oak light oil, FSC Mix 70%	1.445
20212052000000	Natural canvas	Oak oil, FSC Mix 70%	1.445
20212071000000	Black canvas	Smoked oak, oiled, FSC Mix 70%	1.565

Extra charge for

Armrests in black or natural saddle leather: +115

Certifications

FSC® certified
EN 1022:2005, EN 16139:2013 (L1)

Model P2031

The Canvas Chair Accessories Seat cushion for 2021, 2031 & 2131

Modeldetails



Designed by Børge Mogensen

Loose seat cushion for The Canvas Chair and Canvas 21 Chair in HR or CMHR-foam. Seat cushion has removable cover.

Loose seat cushion for the Canvas Chair outdoor in outdoor-foam with Performance canvas. Seat cushions has removable cover.



Essential Assortment

Pre-configured

Item number	Upholstery	Price
P2031499980	Natural canvas	230
P2031499990	Black canvas	230
P203149994A	Performance canvas, papyrus	230

Essential variants only delivered with HR foam

Order configuration

Leather group 0	380
Leather group 1	410
Leather group 2	480
Leather group 3	550
Leather group 4	625
Leather group 5	715
C.O.M. leather	410
Canvas black or natural	230
Performance canvas	230

Recommended upholstery

Leather group 0	Vice
Leather group 1	Omni
Leather group 2	Primo, Trace
Leather group 3	Max
Leather group 4	Nubuck, Vegeta, Organic, Cera

Model 2031

The Canvas Chair Lounge chair



Designed by Børge Mogensen, 1970

Lounge chair of solid wood and canvas. Interchangeable seat and back made of 100% linen canvas.

Modeldetails

0,5 m³ Packaging dimensions:
13,8 kg / 8,3 kg L: 81 cm W: 72 cm H: 85 cm

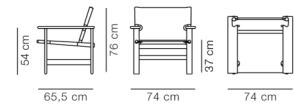

Essential Assortment

Pre-configured

Item number	Seat and back	Wood	Price
20312062000	Natural canvas	Oak light oil, FSC Mix 70%	1.805
20312251000	Black canvas	Oak black lacquer, FSC Mix 70%	1.805
20312052000	Natural canvas	Oak oil, FSC Mix 70%	1.805
20312071000	Black canvas	Smoked oak, oiled, FSC Mix 70%	2.050

Order configuration

Oak soap Canvas natural	Oak oiled Canvas natural	Oak light oil Canvas natural	Oak black lacquered Canvas black	Smoked oak, oiled Canvas black
2.005	1.805	1.805	1.805	2.050

+35

Certifications

FSC® certified

BS 5852:Part 1:1979 - Match flame equivalent, BS 5852:Part 1:1979 - Smouldering cigarette, EN 1022:2005, EN 16139:2013 (L2)

Model 2131

The Canvas Chair Outdoor



Designed by Børge Mogensen, 2025

Lounge chair of solid wood and performance canvas. Interchangeable seat and back.

Modeldetails

0,5 m³ Packaging dimensions:
12,5 kg / 7 kg L: 81 cm W: 72 cm H: 85 cm

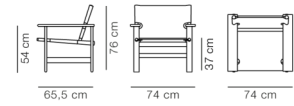

Essential Assortment

Pre-configured

Item number	Seat and back	Wood	Price
21312315500	Performance canvas, papyrus	Teak untreated, FSC Mix 70%	1.770

Certifications

FSC® certified
EN 1022:2005, EN 16139:2013 (L2)

Model P2031

The Canvas Chair Accessories Seat cushion for 2021, 2031 & 2131

Modeldetails



Designed by Børge Mogensen

Loose seat cushion for The Canvas Chair and Canvas 21 Chair in HR or CMHR-foam. Seat cushion has removable cover.

Loose seat cushion for the Canvas Chair outdoor in outdoor-foam with Performance canvas. Seat cushions has removable cover.

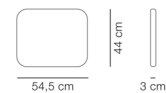

Essential Assortment

Pre-configured

Item number	Upholstery	Price
P2031499980	Natural canvas	230
P2031499990	Black canvas	230
P203149994A	Performance canvas, papyrus	230

Essential variants only delivered with HR foam

Order configuration

Leather group 0	380
Leather group 1	410
Leather group 2	480
Leather group 3	550
Leather group 4	625
Leather group 5	715
C.O.M. leather	410
Canvas black or natural	230
Performance canvas	230

Recommended upholstery

Leather group 0	Vice
Leather group 1	Omni
Leather group 2	Primo, Trace
Leather group 3	Max
Leather group 4	Nubuck, Vegeta, Organic, Cera

**Model
R2031**

The Canvas Chair Accessories
Complete canvas set for 2031

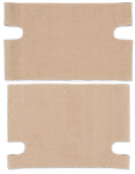

Designed by Børge Mogensen

Complete canvas set for The Canvas Chair in 100% linen canvas.

Order configuration

	Canvas natural	Canvas black	Performance canvas
	700	700	700

Model 5000



Corona Chair Swivel base

Designed by Poul M. Volther, 1964

Swivel lounge chair. Seat and back of four separate pads of moulded cold cured foam in HR or CMHR foam, fully upholstered in fabric or leather. Cover is non-removable. Spring steel swivel base and frame. Mounted with natural fibre glides, as an alternative to felt.

Modeldetails

0,56 m³ Packaging dimensions:
37 kg / 29 kg L: 95/60 cm W: 85/55 cm H: 52/29 cm

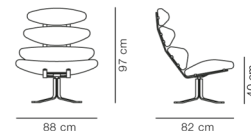

Essential Assortment

Pre-configured

Item number	Upholstery	Frame	Price
500051301050000	Leather Omni 301, Black	Brushed steel	5.065
500050095050000	Leather Max 95, Cognac	Brushed steel	5.550

Essential variants only delivered with HR foam

Order configuration

	Black	Brushed steel
Fabric group 1	3.975	3.975
Fabric group 2	4.090	4.090
Fabric group 3	4.205	4.205
Fabric group 4	4.395	4.395
Fabric group 5	4.780	4.780
C.O.M. fabric	3.975	3.975
Leather group 1	5.065	5.065
Leather group 2	5.370	5.370
Leather group 3	5.550	5.550
Leather group 4	5.875	5.875
Leather group 5	7.060	7.060
C.O.M. leather	5.065	5.065

Fabric consumption: 2 m. Leather consumption: 5 m²

Recommended upholstery

Fabric group 1	Natural Linen, Erik, Remix, Gran Linen, Capture, Bardal, Re-wool, Linara
Fabric group 2	Loop, Steelcut Trio, Hallingdal, Barnum, Fiord, Ruskin
Fabric group 3	Vidar, Divina Melange, Sunniva, Clay
Fabric group 4	Safire, Cotil, Elle, Sisu
Fabric group 5	Grand Mohair, Gentle
Leather group 1	Omni
Leather group 2	Primo, Trace
Leather group 3	Max
Leather group 4	Nubuck, Vegeta, Organic

Model 5002

Corona Ottoman



Designed by Poul M. Volther, 1964

Ottoman of cold cured foam in HR or CMHR foam, reinforced with steel, fully upholstered in fabric or leather. Cover is non-removable. Spring steel base and frame. Mounted with natural fibre glides, as an alternative to felt.

Modeldetails

0,17 m³ Packaging dimensions:
12 kg / 10 kg L: 75 cm W: 46 cm H: 47 cm

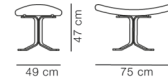

Essential Assortment

Pre-configured

Item number	Upholstery	Frame	Price
500251301050000	Leather Omni 301, Black	Brushed steel	1.815
500250095050000	Leather Max 95, Cognac	Brushed steel	2.135

Essential variants only delivered with HR foam

Order configuration

	Black	Brushed steel
Fabric group 1	1.445	1.445
Fabric group 2	1.495	1.495
Fabric group 3	1.540	1.540
Fabric group 4	1.610	1.610
Fabric group 5	1.780	1.780
C.O.M. fabric	1.445	1.445
Leather group 1	1.815	1.815
Leather group 2	1.940	1.940
Leather group 3	2.135	2.135
Leather group 4	2.405	2.405
Leather group 5	2.875	2.875
C.O.M. leather	1.815	1.815

Fabric consumption: 0,85 m. Leather consumption: 2,5 m²

Recommended upholstery

Fabric group 1	Natural Linen, Erik, Remix, Gran Linen, Capture, Bardal, Re-wool, Linara
Fabric group 2	Loop, Steelcut Trio, Hallingdal, Barnum, Flord, Ruskin
Fabric group 3	Vidar, Divina Melange, Sunniva, Clay
Fabric group 4	Safire, Cotil, Elle, Sisù
Fabric group 5	Grand Mohair, Gentle
Leather group 1	Omni
Leather group 2	Primo, Trace
Leather group 3	Max
Leather group 4	Nubuck, Vegeta, Organic

Model 2631

Ditzel Lounge Chair Wood base, Sheepskin



Designed by Nanna Ditzel, 1953

Upholstered lounge chair with legs of solid wood mounted with metal thread. Body moulded in cold cured foam, HR or CMHR foam, reinforced with steel frame. Upholstered in sheepskin. Cover is non-removable.

Modeldetails

0,72 m³ Packaging dimensions:
28 kg / 15 kg L: 88 cm W: 80 cm H: 77 cm



Essential Assortment

Pre-configured

Item number	Upholstery	Legs	Price
2631499800000102020	Sheepskin Moonlight	Oak lacquer, FSC Mix 70%	3.565
2631499800000101620	Sheepskin Moonlight	Walnut lacquer	3.565

Essential variants only delivered with HR foam

Order configuration

	Oak lacquered	Oak oiled	Smoked oak stained, lacquered	Walnut lacquered
Sheepskin	3.565	3.565	3.565	3.565

Fabric consumption: 2,5 m. Leather consumption: 4 m²

Certifications

Oak is FSC® certified

EN 1022:2005, EN 16139:2013 (L2), ANSI/BIFMA X7.1/M7.1/e3-2019 VOC test (tested with HR foam and EU Ecolabel fabric)

Model 2632

Ditzel Lounge Chair Wood base



Designed by Nanna Ditzel, 1953

Legs of solid wood mounted with metal thread. Body moulded in cold cured foam, HR or CMHR foam with batting, reinforced with steel frame. Upholstered in fabric or leather with piping in the same upholstery. Available with piping in leather when upholstered in fabric. Cover is non-removable.

Modeldetails

0,72 m³ Packaging dimensions:
27 kg / 14 kg L: 88 cm W: 80 cm H: 77 cm



Essential Assortment

Pre-configured

Item number	Upholstery	Legs	Price
26320026890020500	Hallingdal 116	Oak oil, FSC Mix 70%	1.915

Order configuration

	Oak lacquered	Oak oiled	Smoked oak stained, lacquered	Walnut lacquered
Fabric group 1	1.740	1.740	1.740	1.740
Fabric group 2	1.915	1.915	1.915	1.915
Fabric group 3	2.070	2.070	2.070	2.070
Fabric group 4	2.375	2.375	2.375	2.375
Fabric group 5	2.765	2.765	2.765	2.765
C.O.M. fabric	1.740	1.740	1.740	1.740
Leather group 1	2.300	2.300	2.300	2.300
Leather group 2	2.645	2.645	2.645	2.645
Leather group 3	2.990	2.990	2.990	2.990
Leather group 4	3.350	3.350	3.350	3.350
Leather group 5	3.855	3.855	3.855	3.855
C.O.M. leather	2.300	2.300	2.300	2.300

Fabric consumption: 2,5 m. Leather consumption: 4 m²

Two additional seams on front and back when upholstered in leather.

Possibility of upholstery in other textiles in addition to recommended upholstery, two extra seams on front and back can occur.

When upholstered in fabric, piping is available in leather: 88 Black, 95 Cognac or 90 Natural.

Certifications

Oak is FSC® certified

EN 1022:2005, EN 16139:2013 (L2), ANSI/BIFMA X7.1/M7.1/e3-2019 VOC test (tested with HR foam and EU Ecolabel fabric)

Recommended upholstery

Fabric group 1	Capture, Bardal
Fabric group 2	Hallingdal, Ruskin, Barnum, Steelcut Trio
Fabric group 3	Divina Melange, Clay
Fabric group 4	Elle, Sisu
Fabric group 5	Gentle
Leather group 1	Omni
Leather group 2	Primo, Trace
Leather group 3	Max
Leather group 4	Nubuck, Vegeta, Organic

Model 4850

Eyes Lounge 4 Leg Chair 4-Leg tube base



Designed by Foersom & Hiort-Lorenzen, 2011

Fully upholstered shell in cold cured foam in HR or CMHR foam, reinforced with a steel frame, covered in fabric or leather. Cover is non-removable. Base of steel tube mounted with plastic glides. Felt glides available.

Modeldetails

0,47 m³ Packaging dimensions:
19 kg / L: 77 cm W: 76 cm H: 80 cm
16 kg

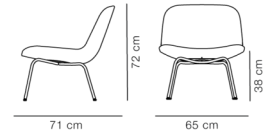

Order configuration

	Black	Brushed stainless steel
Fabric group 0	1.010	1.010
Fabric group 1	1.085	1.085
Fabric group 2	1.195	1.195
Fabric group 3	1.245	1.245
Fabric group 4	1.400	1.400
Fabric group 5	1.680	1.680
C.O.M. fabric	1.085	1.085
Leather group 0	1.700	1.700
Leather group 1	1.830	1.830
Leather group 2	2.045	2.045
Leather group 3	2.390	2.390
Leather group 4	2.560	2.560
Leather group 5	2.940	2.940
C.O.M. leather	1.830	1.830

Fabric consumption: 1,5 m. Leather consumption: 3 m²
As standard delivered without decoration buttons.

Available while stocks last.

Extra charge for

Buttons in the same upholstery as the chair or in selected leather: +103

Certifications

EN 1022:2005, EN 16139:2013 (L1)

Recommended upholstery

Fabric group 0	Connect
Fabric group 1	Remix, Bardal, Re-wool, Capture, Linara, Natural Linen, Erik
Fabric group 2	Hallingdal, Barnum, Fiord, Steelcut Trio, Loop, Ruskin
Fabric group 3	Sunniva, Vidar, Divina Melange, Clay
Fabric group 4	Safire, Sisu, Elle, Cotil
Fabric group 5	Gentle
Leather group 0	Vice
Leather group 1	Omni
Leather group 2	Primo, Trace
Leather group 3	Max
Leather group 4	Vegeta, Organic, Nubuck

Model 4854

Eyes Lounge Wood Chair Wood base



Designed by Foersom & Hiort-Lorenzen, 2011

Fully upholstered shell in cold cured foam in HR or CMHR foam, reinforced with a steel frame, covered in fabric or leather. Cover is non-removable. Base of solid wood.

Modeldetails

0,5 m³ Packaging dimensions:
13 kg / 10 kg L: 77 cm W: 76 cm H: 80 cm

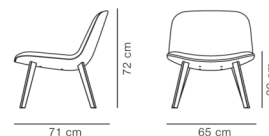

Essential Assortment

Pre-configured

Item number	Upholstery	Frame	Price
48541931100006000100	Re-Wool 128	Oak lacquer	1.085
48544452400006000100	Gentle 873	Oak lacquer	1.680

Essential variants only delivered with HR foam

Order configuration

	Oak lacquered	Smoked oak stained
Fabric group 0	1.010	1.010
Fabric group 1	1.085	1.085
Fabric group 2	1.195	1.195
Fabric group 3	1.245	1.245
Fabric group 4	1.400	1.400
Fabric group 5	1.680	1.680
C.O.M. fabric	1.085	1.085
Leather group 0	1.700	1.700
Leather group 1	1.830	1.830
Leather group 2	2.045	2.045
Leather group 3	2.390	2.390
Leather group 4	2.560	2.560
Leather group 5	2.940	2.940
C.O.M. leather	1.830	1.830

Fabric consumption: 1,5 m. Leather consumption: 3 m²

As standard delivered without decoration buttons.

Available while stocks last.

Extra charge for

Buttons in the same upholstery as the chair or in selected leather: +103

Certifications

EN 1022:2005, EN 16139:2013 (L1)

Recommended upholstery

Fabric group 0	Connect
Fabric group 1	Remix, Linara, Bardal, Capture, Re-wool, Natural Linen, Erik
Fabric group 2	Steelcut Trio, Ruskin, Barnum, Fiord, Hallingdal, Loop
Fabric group 3	Sunniva, Clay, Vidar, Divina Melange
Fabric group 4	Elle, Safire, Sisu, Cotil
Fabric group 5	Gentle
Leather group 0	Vice
Leather group 1	Omni
Leather group 2	Primo, Trace
Leather group 3	Max
Leather group 4	Vegeta, Organic, Nubuck

Model 4856

Eyes Lounge Wood Armchair Wood base



Designed by Foersom & Hiort-Lorenzen, 2011

Fully upholstered shell in cold cured foam in HR or CMHR foam, reinforced with a steel frame, covered in fabric or leather. Cover is non-removable. Base and armrests of solid wood.

Modeldetails

0,5 m³ Packaging dimensions:
14 kg / 11 kg L: 77 cm W: 76 cm H: 80 cm

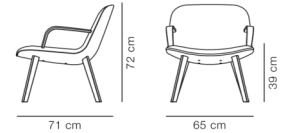

Essential Assortment

Pre-configured

Item number	Upholstery	Frame	Price
48561931100006000100	Re-Wool 128	Oak lacquer	1.715
48564452400006000100	Gentle 873	Oak lacquer	2.435

Essential variants only delivered with HR foam

Order configuration

	Oak lacquered	Smoked oak stained
Fabric group 0	1.595	1.595
Fabric group 1	1.715	1.715
Fabric group 2	1.825	1.825
Fabric group 3	1.875	1.875
Fabric group 4	2.030	2.030
Fabric group 5	2.435	2.435
C.O.M. fabric	1.715	1.715
Leather group 0	2.285	2.285
Leather group 1	2.460	2.460
Leather group 2	2.680	2.680
Leather group 3	3.020	3.020
Leather group 4	3.190	3.190
Leather group 5	3.665	3.665
C.O.M. leather	2.460	2.460

Fabric consumption: 1,5 m. Leather consumption: 3 m²
As standard delivered without decoration buttons.

Available while stocks last.

Extra charge for

Buttons in the same upholstery as the chair or in selected leather: +103

Recommended upholstery

Fabric group 0	Connect
Fabric group 1	Remix, Bardal, Re-wool, Capture, Linara, Natural Linen, Erik
Fabric group 2	Hallingdal, Barnum, Fiord, Steelcut Trio, Loop, Ruskin
Fabric group 3	Sunniva, Vidar, Divina Melange, Clay
Fabric group 4	Safire, Sisu, Elle, Cotil
Fabric group 5	Gentle
Leather group 0	Vice
Leather group 1	Omni
Leather group 2	Primo, Trace
Leather group 3	Max
Leather group 4	Vegeta, Organic, Nubuck

Model 4858

Eyes Lounge Swivel Chair Swivel base



Designed by Foersom & Hiort-Lorenzen, 2011

Fully upholstered shell in cold cured foam in HR or CMHR foam, reinforced with a steel frame covered in fabric or leather. Cover is non-removable. 4-point swivel base in polished or powder coated aluminium. Mounted with reversible plastic glides which can be changed to felt when reversed.

Modeldetails

0,5 m³ Packaging dimensions:
19 kg / 16 kg L: 77 cm W: 76 cm H: 80 cm

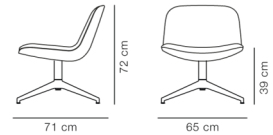

Order configuration

	Black	Polished aluminium
Fabric group 0	1.065	1.065
Fabric group 1	1.145	1.145
Fabric group 2	1.260	1.260
Fabric group 3	1.315	1.315
Fabric group 4	1.480	1.480
Fabric group 5	1.775	1.775
C.O.M. fabric	1.145	1.145
Leather group 0	1.795	1.795
Leather group 1	1.930	1.930
Leather group 2	2.165	2.165
Leather group 3	2.525	2.525
Leather group 4	2.705	2.705
Leather group 5	3.110	3.110
C.O.M. leather	1.930	1.930

Fabric consumption: 1,5 m. Leather consumption: 3 m²
As standard delivered without decoration buttons.

Available while stocks last.

Extra charge for

Buttons in the same upholstery as the chair or in selected leather: +103

Recommended upholstery

Fabric group 0	Connect
Fabric group 1	Remix, Bardal, Re-wool, Capture, Linara, Natural Linen, Erik
Fabric group 2	Hallingdal, Barnum, Fiord, Steelcut Trio, Loop, Ruskin
Fabric group 3	Sunniva, Vidar, Divina Melange, Clay
Fabric group 4	Safire, Sisu, Elle, Cotil
Fabric group 5	Gentle
Leather group 0	Vice
Leather group 1	Omni
Leather group 2	Primo, Trace
Leather group 3	Max
Leather group 4	Vegeta, Organic, Nubuck

Model 5721

Gomo Lounge Chair



Designed by Hugo Passos, 2023

Fully upholstered lounge chair. Inner construction consists of a wooden shell in moulded plywood and furniture board and seat is supported with webbing. Upholstered in HR or CMHR foam and cover in fabric or leather. Fabric cover is removable. Two base options available: A fixed base with plastic legs with reversible plastic glides which can be changed to felt. A metal swivel base with a black lacquered wooden plate mounted with plastic glides. Felt glides available.

Modeldetails

0,37 m³ Packaging dimensions:
27 kg / 25 kg L: 67 cm W: 72 cm H: 76 cm

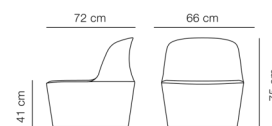

Essential Assortment

Pre-configured

Item number	Upholstery	Frame	Price
5721193000005503271	Re-Wool 198	Fixed base, FSC Mix 70%	1.705
57211931100005503271	Re-Wool 128	Fixed base, FSC Mix 70%	1.705
5721193000005503305	Re-Wool 198	Swivel base, FSC Mix 70%	1.945
57211931100005503305	Re-Wool 128	Swivel base, FSC Mix 70%	1.945
5721499800005503271	Sheepskin Moonlight	Fixed base, FSC Mix 70%	3.125
5721499800005503305	Sheepskin Moonlight	Swivel base, FSC Mix 70%	3.370

Essential variants are delivered with plastic glides and HR foam

Order configuration

	Fixed base	Swivel base
Fabric group 0	1.585	1.810
Fabric group 1	1.705	1.945
Fabric group 2	1.815	2.055
Fabric group 3	1.925	2.160
Fabric group 4	2.110	2.340
Fabric group 5	2.470	2.690
C.O.M. fabric	1.705	1.945
Leather group 0	2.075	2.340
Leather group 1	2.260	2.525
Leather group 2	2.440	2.700
Leather group 3	2.655	2.905
Leather group 4	3.035	3.285
Leather group 5	3.700	3.950
C.O.M. leather	2.260	2.525
Sheepskin	3.125	3.370

Fabric consumption: 1,9 m. Leather consumption: 3,8 m²

When upholstered in velvet the stitching will not be visible.

Extra charge for

Return function base: +55

Certifications

FSC® certified

EU Ecolabel variants: Fixed or Swivel base together with HR foam and upholstery in Connect, Remix, Re-wool, Steelcut Quartet, Vidar, Tonus fabric

ANSI/BIFMA X5.4-2020

Recommended upholstery

Fabric group 0	Connect
Fabric group 1	Erik, Capture, Re-wool, Bardal, Linara, Remix, Gran Linen
Fabric group 2	Barnum, Steelcut Trio, Ruskin, Fiord, Hallingdal, Loop
Fabric group 3	Sunniva, Divina Melange, Vidar, Clay, Tonus, Zero
Fabric group 4	Safire, Sisu, Elle
Fabric group 5	Gentle
Leather group 0	Vice
Leather group 1	Omni
Leather group 2	Primo, Trace
Leather group 3	Max
Leather group 4	Organic, Vegeta, Nubuck

Model P5721

Gomo Accessories Loose cover for Gomo Lounge Chair



Designed by Hugo Passos, 2023

Loose textile cover for re-upholstery of Gomo Chair. Please note there will not be visible stitching in velour textiles.
Professional assistance is recommended.

Order configuration

Fabric group 0	510
Fabric group 1	550
Fabric group 2	585
Fabric group 3	615
Fabric group 4	665
Fabric group 5	780
C.O.M. fabric	550

Fabric consumption: 1,9 m

Recommended upholstery

Fabric group 0	Connect
Fabric group 1	Gran Linen, Capture, Re-wool, Bardal, Linara, Remix, Erik
Fabric group 2	Barnum, Steelcut Trio, Ruskin, Fiord, Hallingdal, Loop
Fabric group 3	Sunniva, Divina Melange, Vidar, Clay, Tonus, Zero
Fabric group 4	Safire, Sisu, Elle
Fabric group 5	Gentle

Model 2229

The Hunting Chair Lounge chair



Designed by Børge Mogensen, 1950

Lounge chair of solid wood and saddle leather. Interchangeable seat and back made in vegetable tanned saddle leather with metal buckles. Leather seat has canvas backing. Saddle straps can be tightened as the leather expands through use.

Modeldetails

0,45 m³ Packaging dimensions:
13 kg / L: 74 cm W: 88 cm H: 74 cm
10,5 kg

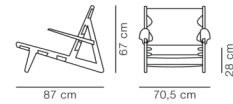

Essential Assortment

Pre-configured

Item number	Upholstery	Wood		Price
222920650502	Leather, cognac	Oak light oil, FSC Mix 70%		4.795
222923450510	Leather, dark brown	Ash light oil, FSC Mix 70%	75th Anniversary edition	4.825
222920350500	Leather, natural	Oak soap, FSC Mix 70%		5.290
222920750501	Leather, black	Smoked oak, oiled, FSC Mix 70%		5.660

Order configuration

	Oak soap	Oak oiled	Oak light oil	Smoked oak, oiled
Natural leather	5.290	5.735	5.735	6.595
Black leather	5.175	5.175	5.175	5.660
Cognac leather	5.175	5.175	4.795	5.950

The 75th Anniversary edition is available from September in a limited production of 75 pcs.
Please contact your local Sales representative.

Certifications

Oak (soap, oiled, light oil, smoked oiled) is FSC® certified
Ash is FSC® certified
EN 1022:2005, EN 16139:2013 (L1)

**Model
P2229**

The Hunting Chair Accessories

Complete leather set for 2229

Designed by Børge Mogensen



Complete leather set made in vegetable tanned saddle leather with metal buckles. Leather seat has canvas backing. Saddle straps can be tightened as the leather expands through use.

Order configuration

	Natural leather	Black leather	Cognac leather
	3.280	2.675	2.675

Model 2711

Jota Lounge chair



Designed by Jasper Morrison, 2024

Fully upholstered lounge chair with internal frame of wood and seat supported with supportive webbing. Available with cover in fabric where seat and back cushions are removable covers while cover on frame is fixed. Cushions are with down and foam granulate mix in separate chambers, in addition seat cushion is made with a foam core. Cover is done with piping on gables and french stitching details on cushions. Mounted with oak legs with felt glides.

Modeldetails

0,92 m³ Packaging dimensions:
49 kg / 38,5 kg L: 99 cm W: 82 cm H: 113 cm

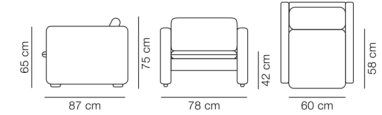

Essential Assortment

Pre-configured

Item number	Upholstery	Legs	Cushion	Price
27114705534000050206	Vidar 693	Oak light oil, FSC Mix 70%	Arm cushions not included	2.910

Order configuration

Legs: wooden legs in either Oak light oil, Oak lacquered or oak black lacquered.

Fabric group 1	2.410
Fabric group 2	2.665
Fabric group 3	2.910
Fabric group 4	3.275
Fabric group 5	4.150
C.O.M. fabric	2.410

Fabric consumption: 5,5 m

Certifications

FSC® certified
EN 1022:2005, EN 16139:2013 (L2)

Recommended upholstery

Fabric group 1	Bardal, Capture, Re-wool
Fabric group 2	Barnum, Steelcut Trio, Fiord, Ruskin, Loop
Fabric group 3	Vidar, Clay, Divina Melange
Fabric group 4	Sisu, Elle, Safire

Model P2711

Jota Accessories Decorative cushion

Modeldetails



Designed by Jasper Morrison, 2024

Decorative cushion with french stitching details for Jota. Down and foam granulate mix filling. Removable cover in fabric.

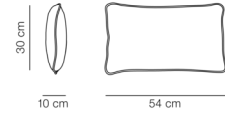

Essential Assortment

Pre-configured

Item number	Upholstery	Price
P271100055240	Vidar 323	175
P271100055340	Vidar 693	175
P271100055720	Vidar 146	175

Order configuration

Fabric group 1	130
Fabric group 2	155
Fabric group 3	175
Fabric group 4	210
Fabric group 5	295
C.O.M. fabric	130

Fabric consumption: 0,65 m

Recommended upholstery

Fabric group 1	Bardal, Capture, Re-wool
Fabric group 2	Barnum, Steelcut Trio, Fiord, Ruskin, Loop, Hallingdal
Fabric group 3	Vidar, Clay, Divina Melange
Fabric group 4	Sisu, Elle, Safire

Model 2204



Mogensen Wing Chair Easy Chair

Designed by Børge Mogensen, 1963

Fully upholstered easy chair with piping in all stitches. Available in leather or fabric. Fixed legs of solid wood, built into the wood internal frame. Seat is supported with jute and rubber band webbing. Separate seat cushion with removable covers. Please specify cushion type. Cushions are either with foam core with down wrap or filled with a foam and down mix in separate chambers. External cover is non-removable.

Modeldetails

0,95 m³ Packaging dimensions:
65 kg / 29 kg L: 96 cm W: 77 cm H: 129 cm

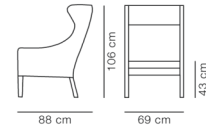

Essential Assortment

Pre-configured

Item number	Upholstery	Wood	Price
22041035009010	Leather Vegeta 90, Natural	Oak soap	9.850
22041075084110	Leather Cera 905, Russet brown	Oak light oil	9.850

Essential variants only delivered with HR foam

Order configuration

	Oak soap	Oak oiled	Oak light oil	Oak black lacquered	Walnut oiled
Fabric group 1	5.705	5.705	5.705	5.705	5.705
Fabric group 2	6.040	6.040	6.040	6.040	6.040
Fabric group 3	6.360	6.360	6.360	6.360	6.360
Fabric group 4	6.840	6.840	6.840	6.840	6.840
Fabric group 5	7.950	7.950	7.950	7.950	7.950
Leather group 2	7.670	7.670	7.670	7.670	7.670
Leather group 3	8.595	8.595	8.595	8.595	8.595
Leather group 4	9.850	9.850	9.850	9.850	9.850
Leather group 5	11.280	11.280	11.280	11.280	11.280

Fabric consumption: 5,8 m. Leather consumption: 11,61 m²

Recommended upholstery

Fabric group 1	Capture, Re-wool, Linara, Erik, Bardal
Fabric group 2	Hallingdal, Steelcut Trio, Savoy, Barnum, Loop, Ruskin, Fiord
Fabric group 3	Clay, Vidar, Divina Melange, Sunniva
Fabric group 4	Safire, Sisu
Fabric group 5	Gentle
Leather group 2	Primo, Trace
Leather group 3	Max
Leather group 4	Vegeta, Nubuck, Organic, Cera

Model 2207

Mogensen Club Chair Lounge Chair



Designed by Børge Mogensen, 1963

Fully upholstered lounge chair with piping in all stitches. Available in leather or fabric. Fixed legs of solid wood, built into the wood internal frame. Seat is supported with jute and rubber band webbing. Separate seat and back cushions with removable covers. Please specify cushion type. Cushions are either with foam core with down wrap or filled with a foam and down mix in separate chambers. External cover is non-removable.

Modeldetails

0,53 m³ Packaging dimensions:
31 kg / 24 kg L: 86 cm W: 73 cm H: 86 cm

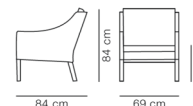

Essential Assortment

Pre-configured

Item number	Upholstery	Wood	Price
22071035009010	Leather Vegeta 90, Natural	Oak soap	7.335
22071075084110	Leather Cera 905, Russet brown	Oak light oil	7.335

Essential variants only delivered with HR foam

Order configuration

	Oak soap	Oak oiled	Oak light oil	Oak black lacquered	Walnut oiled
Fabric group 1	4.200	4.200	4.200	4.200	4.200
Fabric group 2	4.500	4.500	4.500	4.500	4.500
Fabric group 3	4.785	4.785	4.785	4.785	4.785
Fabric group 4	5.215	5.215	5.215	5.215	5.215
Fabric group 5	6.195	6.195	6.195	6.195	6.195
Leather group 2	5.645	5.645	5.645	5.645	5.645
Leather group 3	6.360	6.360	6.360	6.360	6.360
Leather group 4	7.335	7.335	7.335	7.335	7.335
Leather group 5	9.030	9.030	9.030	9.030	9.030

Fabric consumption: 5 m. Leather consumption: 8,71 m²

Recommended upholstery

Fabric group 1	Capture, Re-wool, Linara, Erik, Bardal
Fabric group 2	Barnum, Steelcut Trio, Savoy, Loop, Fiord, Ruskin, Hallingdal
Fabric group 3	Clay, Divina Melange, Vidar, Sunniva
Fabric group 4	Safire, Sisu
Fabric group 5	Gentle
Leather group 2	Primo, Trace
Leather group 3	Max
Leather group 4	Vegeta, Nubuck, Organic, Cera

Model 2202

Mogensen Ottoman 58x58 cm

Modeldetails

0,2 m³ Packaging dimensions:
11 kg / 9 kg L: 60 cm W: 60 cm H: 55 cm



Designed by Børge Mogensen, 1963

Fully upholstered ottoman with piping in all stitches. Available in leather or fabric. Fixed legs of solid wood, built into the wood internal frame. Seat is supported with polyamide webbing. Cover on frame is non-removable. Separate seat cushion with removable cover. Please specify cushion type. Cushions are either with foam core with down wrap or filled with a foam and down mix in separate chambers.

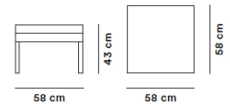

Essential Assortment

Pre-configured

Item number	Upholstery	Wood	Price
22021035009010	Leather Vegeta 90, Natural	Oak soap	2.705
22021075084110	Leather Cera 905, Russet brown	Oak light oil	2.705

Essential variants only delivered with HR foam

Order configuration

	Oak soap	Oak oiled	Oak light oil	Oak black lacquered	Walnut oiled
Fabric group 1	1.865	1.865	1.865	1.865	1.865
Fabric group 2	2.010	2.010	2.010	2.010	2.010
Fabric group 3	2.150	2.150	2.150	2.150	2.150
Fabric group 4	2.360	2.360	2.360	2.360	2.360
Fabric group 5	2.815	2.815	2.815	2.815	2.815
Leather group 2	2.220	2.220	2.220	2.220	2.220
Leather group 3	2.470	2.470	2.470	2.470	2.470
Leather group 4	2.705	2.705	2.705	2.705	2.705
Leather group 5	3.105	3.105	3.105	3.105	3.105

Fabric consumption: 2,5 m. Leather consumption: 3,13 m²

Recommended upholstery

Fabric group 1	Re-wool, Capture, Linara, Erik, Bardal
Fabric group 2	Loop, Steelcut Trio, Savoy, Barnum, Fiord, Ruskin, Hallingdal
Fabric group 3	Clay, Vidar, Divina Melange, Sunniva
Fabric group 4	Safire, Sisu
Fabric group 5	Gentle
Leather group 2	Primo, Trace
Leather group 3	Max
Leather group 4	Vegeta, Nubuck, Organic, Cera

Model 7421

Mono Pouf Ø39 cm



Designed by Due & Trampedach, 2020

Fully upholstered pouf with piping in all stitches. Inner frame of wood, seat undercarriage with webbing. Upholstered with HR or CMHR foam. Base in black lacquered MDF mounted with plastic glides. Available in fabric or leather. The cover is non-removable.

Modeldetails

0,1 m³ Packaging dimensions:
7,5 kg / 5,6 kg L: 44 cm W: 44 cm H: 50 cm

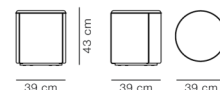

Essential Assortment

Pre-configured

Item number	Upholstery	Price
7421448070000000053	Grand Linen Naturel 0024	705
7421513010000000053	Leather Omni 301, Black	1.070

Essential variants are delivered with plastic glides and HR foam

Order configuration

Fabric group 0	625
Fabric group 1	705
Fabric group 2	785
Fabric group 3	860
Fabric group 4	1.000
Fabric group 5	1.185
C.O.M. fabric	705
Leather group 1	1.070
Leather group 2	1.240
Leather group 3	1.420
Leather group 4	1.585
Leather group 5	1.820
C.O.M. leather	1.070

Fabric consumption: 1,3 m. Leather consumption: 2,4 m²

Certifications

EN 1022:2005, EN 16139:2013 (L2)

Recommended upholstery

Fabric group 0	Connect
Fabric group 1	Gran Linen, Remix, Capture, Bardal, Re-wool, Linara, Natural Linen, Erik
Fabric group 2	Hallingdal, Barnum, Loop, Steelcut Trio, Fiord, Ruskin, Savoy
Fabric group 3	Divina Melange, Vidar, Sunniva, Clay
Fabric group 4	Sisu, Safire, Elle, Cotil
Fabric group 5	Grand Mohair, Gentle
Leather group 0	Vice
Leather group 1	Omni
Leather group 2	Primo, Trace
Leather group 3	Max
Leather group 4	Nubuck, Organic, Vegeta, Cera

Model 7423

Mono Pouf Ø55 cm



Designed by Due & Trapedach, 2020

Fully upholstered pouf with piping in all stitches. Inner frame of wood, seat undercarriage with webbing. Upholstered with HR or CMHR foam. Base in black lacquered MDF mounted with plastic glides. Available in fabric or leather. The cover is non-removable.

Modeldetails

0,17 m³ Packaging dimensions:
11 kg / 8,2 kg L: 61 cm W: 61 cm H: 45 cm

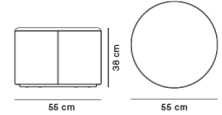

Essential Assortment

Pre-configured

Item number	Upholstery	Price
7423448070000000053	Grand Linen Naturel 0024	795
7423513010000000053	Leather Omni 301, Black	1.175

Essential variants are delivered with plastic glides and HR foam

Order configuration

Fabric group 0	705
Fabric group 1	795
Fabric group 2	880
Fabric group 3	955
Fabric group 4	1.110
Fabric group 5	1.305
C.O.M. fabric	795
Leather group 1	1.175
Leather group 2	1.365
Leather group 3	1.555
Leather group 4	1.755
Leather group 5	2.020
C.O.M. leather	1.175

Fabric consumption: 1,4 m. Leather consumption: 3,2 m²

Certifications

EN 1022:2005, EN 16139:2013 (L2)

Recommended upholstery

Fabric group 0	Connect
Fabric group 1	Gran Linen, Remix, Capture, Bardal, Re-wool, Linara, Natural Linen, Erik
Fabric group 2	Hallingdal, Barnum, Loop, Steelcut Trio, Fiord, Ruskin, Savoy
Fabric group 3	Divina Melange, Vidar, Sunniva, Clay
Fabric group 4	Sisu, Safire, Elle, Cotil
Fabric group 5	Grand Mohair, Gentle
Leather group 0	Vice
Leather group 1	Omni
Leather group 2	Primo, Trace
Leather group 3	Max
Leather group 4	Nubuck, Organic, Vegeta, Cera

Model 4372

Pato Lounge Sledge base



Designed by Welling / Ludvik, 2016

Fully upholstered lounge chair. Frame of solid steel, chromed or powder coated. Inner shell of plywood with HR or CMHR foam, covered in fabric or leather. Cover is non-removable. Mounted with plastic glides.

Modeldetails

0,38 m³ Packaging dimensions:
15 kg / 9 kg L: 84 cm W: 73 cm H: 87 cm

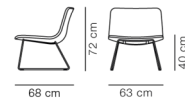

Order configuration

Frame: Chrome or black.

Fabric group 0	860
Fabric group 1	930
Fabric group 2	1.095
Fabric group 3	1.245
Fabric group 4	1.515
Fabric group 5	1.665
C.O.M. fabric	930
Leather group 0	980
Leather group 1	1.055
Leather group 2	1.300
Leather group 3	1.615
Leather group 4	1.780
Leather group 5	2.045
C.O.M. leather	1.055

Fabric consumption: 1,5 m. Leather consumption: 2,5 m²

Other frame colours by quotation.

Extra charge for

Glides with felt: +12

Certifications

FSC® certified

EN 1022:2005, EN 16139:2013 (L1)

Recommended upholstery

Fabric group 0	Connect
Fabric group 1	Bardal, Capture, Remix, Linara, Natural Linen, Erik, Gran Linen, Re-wool
Fabric group 2	Barnum, Savoy, Fiord, Steelcut Trio, Hallingdal, Ruskin, Loop
Fabric group 3	Vidar, Clay, Divina Melange, Sunniva
Fabric group 4	Sisu, Elle, Safire, Cotil
Fabric group 5	Gentle, Grand Mohair
Leather group 0	Vice
Leather group 1	Omni
Leather group 2	Primo, Trace
Leather group 3	Max
Leather group 4	Nubuck, Organic, Cera, Vegeta

Model 3546

Post Lounge Chair



Designed by Cecilie Manz, 2026

Lounge chair in solid wood. Backrest and stretcher in form-pressed veneer with all layers in matching wood. The seat is supported by linen webbing. Seat cushion in HR or CMHR foam with a top layer of fiberfill, upholstered in fabric or leather with a removable cover. The seat cushion is mounted with linen straps and Velcro.

Modeldetails

0,36 m³ Packaging dimensions:
14 kg / 9 kg L: 81 cm W: 67 cm H: 66 cm

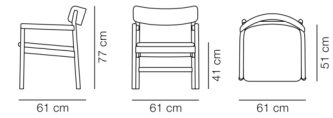

Order configuration

	Oak lacquered	Oak oiled	Oak light oil	Oak black lacquered
Fabric group 0	1.700	1.700	1.700	1.700
Fabric group 1	1.735	1.735	1.735	1.735
Fabric group 2	1.790	1.790	1.790	1.790
Fabric group 3	1.840	1.840	1.840	1.840
Fabric group 4	1.920	1.920	1.920	1.920
Fabric group 5	2.095	2.095	2.095	2.095
C.O.M. fabric	1.735	1.735	1.735	1.735
Leather group 0	1.905	1.905	1.905	1.905
Leather group 1	2.015	2.015	2.015	2.015
Leather group 2	2.120	2.120	2.120	2.120
Leather group 3	2.220	2.220	2.220	2.220
Leather group 4	2.445	2.445	2.445	2.445
Leather group 5	2.835	2.835	2.835	2.835
C.O.M. leather	2.015	2.015	2.015	2.015

Fabric consumption: 1 m. Leather consumption: 1,08 m²

Delivery from October 2025

Extra charge for

QuickClick glides with or without felt: +24

Certifications

FSC® certified
EN 16139:2025 (L1), EN 1022:2023

Recommended upholstery

Fabric group 0	Connect
Fabric group 1	Capture, Bardal, Re-wool, Erik
Fabric group 2	Hallingdal, Barnum, Loop
Fabric group 3	Tonus, Divina Melange, Zero, Vidar, Clay
Fabric group 4	Safire
Leather group 1	Omni
Leather group 2	Primo, Trace
Leather group 3	Max
Leather group 4	Nubuck, Vegeta

Model P3546

Post Lounge Chair Accessories Seat cushion for 3546

Modeldetails

△ 1,2 kg /
1,1 kg

Designed by Cecilie Manz

Seat cushion in HR or CMHR foam with a top layer of fiberfill, upholstered in fabric or leather with a removable cover. Please specify colour on linen straps.

Order configuration

Fabric group 0	260
Fabric group 1	290
Fabric group 2	330
Fabric group 3	370
Fabric group 4	430
Fabric group 5	565
C.O.M. fabric	290
Leather group 0	315
Leather group 1	355
Leather group 2	390
Leather group 3	440
Leather group 4	520
Leather group 5	660
C.O.M. leather	355

Delivery from October 2025

Recommended upholstery

Fabric group 0	Connect
Fabric group 1	Capture, Bardal, Re-wool, Erik
Fabric group 2	Hallingdal, Barnum, Loop
Fabric group 3	Tonus, Divina Melange, Zero, Vidar, Clay
Fabric group 4	Safire
Leather group 1	Omni
Leather group 2	Primo, Trace
Leather group 3	Max
Leather group 4	Nubuck, Vegeta

Model 8805

Savannah Lounge Chair Petit



Designed by Monica Förster, 2022

Lounge chair with upholstered cushions. External frame of solid wood mounted with non-removable upholstery leather, fabric or 100% linen canvas. Cushions of cold cured foam in HR or CMHR foam, upholstered in fabric. Cover is non-removable on frame and back. Cover on seat cushion is removable.

Modeldetails

0,45 m³ Packaging dimensions:
30 kg / 23 kg L: 76 cm W: 74 cm H: 77 cm

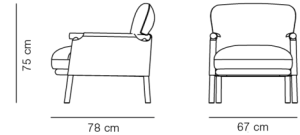

Order configuration

Frame: Oak light oil or oak black lacquered.

	Cushions: Fabric gr. 1	Cushions: Fabric gr. 2	Cushions: Fabric gr. 3	Cushions: Fabric gr. 4	Cushions: Fabric gr. 5	Cushions: Fabric COM
Fabric group 1	3.465	3.590	3.710	3.905	4.190	3.465
Fabric group 2	3.500	3.660	3.745	3.945	4.275	3.500
Fabric group 3	3.570	3.700	3.805	3.985	4.360	3.570
Fabric group 4	3.645	3.735	3.845	4.085	4.445	3.645
Fabric group 5	3.715	3.775	3.885	4.125	4.660	3.715
C.O.M. fabric	3.465	3.590	3.710	3.905	4.190	3.465
Leather group 1	3.585	3.710	3.830	4.030	4.315	3.585
Leather group 2	3.660	3.780	3.905	4.105	4.390	3.660
Leather group 3	3.765	3.885	4.010	4.210	4.495	3.765
Leather group 4	3.870	3.995	4.115	4.315	4.600	3.870
C.O.M. leather	3.585	3.710	3.830	4.030	4.315	3.585
Canvas black or natural	3.465	3.590	3.710	3.905	4.190	3.465

Fabric consumption: 3,2 m

Fabric consumption on frame: 1,5 m.

Leather consumption on frame: 3 m²

Certifications

FSC® certified

EN 1022:2005, EN 16139:2013 (L2), ANSI/BIFMA X7.1/M7.1/e3-2019 VOC test (tested with HR foam and EU Ecolabel fabric)

Recommended upholstery

Fabric group 1	Bardal, Re-wool, Capture, Gran Linen, Erik
Fabric group 2	Hallingdal, Fiord, Steelcut Trio, Ruskin, Barnum, Loop, Savoy
Fabric group 3	Sunniva, Vidar, Divina Melange, Clay
Fabric group 4	Sisu, Safire, Elle
Fabric group 5	Gentle
Leather group 0	Vice
Leather group 1	Omni
Leather group 2	Trace, Primo
Leather group 3	Max
Leather group 4	Vegeta, Nubuck, Organic

Model 8801

Savannah Lounge Chair



Designed by Monica Förster, 2015

Lounge chair with upholstered cushions. External frame of solid wood mounted with non-removable upholstery leather, fabric or 100% linen canvas. Cushions of cold cured foam in HR or CMHR foam, upholstered in fabric. Cover is non-removable on frame and back. Cover on seat cushion is removable.

Modeldetails

0,9 m³ Packaging dimensions:
34 kg / 29 kg L: 111 cm W: 98 cm H: 82 cm

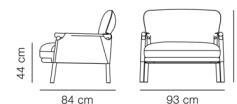

Essential Assortment

Pre-configured

Item number	Upholstery cushions/seat	Upholstery frame	Wood	Price
88015314602038020600	Zero 002	Leather Trace 8146, Olive	Oak light oil, FSC Mix 70%	4.790
88015009305534020600	Vidar 693	Leather Max 93, Indian red	Oak light oil, FSC Mix 70%	4.895

Order configuration

Frame: Oak light oil or oak black lacquered.

	Cushions: Fabric gr. 1	Cushions: Fabric gr. 2	Cushions: Fabric gr. 3	Cushions: Fabric gr. 4	Cushions: Fabric gr. 5	Cushions: Fabric COM
Fabric group 1	4.270	4.510	4.625	4.970	5.965	4.270
Fabric group 2	4.315	4.585	4.675	5.020	6.025	4.315
Fabric group 3	4.360	4.630	4.745	5.070	6.085	4.360
Fabric group 4	4.400	4.680	4.795	5.170	6.145	4.400
Fabric group 5	4.445	4.725	4.845	5.225	6.245	4.445
C.O.M. fabric	4.270	4.510	4.625	4.970	5.965	4.270
Leather group 1	4.360	4.600	4.715	5.060	6.055	4.360
Leather group 2	4.435	4.670	4.790	5.130	6.125	4.435
Leather group 3	4.540	4.780	4.895	5.240	6.235	4.540
Leather group 4	4.650	4.890	5.005	5.350	6.345	4.650
C.O.M. leather	4.360	4.600	4.715	5.060	6.055	4.360
Canvas black or natural	4.270	4.510	4.625	4.970	5.965	4.270

Fabric consumption: 3,2 m

Fabric consumption on frame: 1,5 m.

Leather consumption on frame: 3,5 m²

Note - arm cushions have to be ordered separately (P8801).

Certifications

FSC® certified

EN 1022:2005, EN 16139:2013 (L2), ANSI/BIFMA X7.1/M7.1/e3-2019 VOC test (tested with HR foam and EU Ecolabel fabric)

Recommended upholstery

Fabric group 1	Bardal, Re-wool, Capture, Gran Linen, Erik
Fabric group 2	Hallingdal, Fiord, Steelcut Trio, Ruskin, Barnum, Loop, Savoy
Fabric group 3	Sunniva, Vidar, Divina Melange, Clay
Fabric group 4	Sisu, Safire, Elle
Fabric group 5	Gentle
Leather group 0	Vice
Leather group 1	Omni
Leather group 2	Trace, Primo
Leather group 3	Max
Leather group 4	Vegeta, Nubuck, Organic

Model 2226

The Spanish Chair Lounge chair



Designed by Børge Mogensen, 1958

Lounge chair of solid wood and saddle leather. Interchangeable seat and back made in vegetable tanned saddle leather with metal buckles. Leather seat has canvas backing. Saddle straps can be tightened as the leather expands through use.

Model details

0,41 m³ Packaging dimensions:
16,5 kg / 10,7 kg L: 64 cm W: 87 cm H: 73 cm

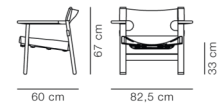

Essential Assortment

Pre-configured

Item number	Upholstery	Wood	Price
222620650502	Leather, cognac	Oak light oil, FSC Mix 70%	3.865
222620350500	Leather, natural	Oak soap, FSC Mix 70%	4.135
222620550500	Leather, natural	Oak oil, FSC Mix 70%	4.135
222616450510	Leather, dark brown	Walnut oiled	4.375
222620750501	Leather, black	Smoked oak, oiled, FSC Mix 70%	4.375

Order configuration

	Oak soap	Oak oiled	Oak light oil	Smoked oak, oiled	Walnut oiled
Natural leather	4.135	4.135	4.135	5.285	5.285
Black leather	3.865	3.865	3.865	4.375	4.375
Cognac leather	3.865	3.865	3.865	4.375	4.375
Dark Brown leather	3.865	3.865	3.865	4.375	4.375

Certifications

Oak is FSC® certified

EN 1021-1:2006 - Smouldering cigarette, EN 1021-2:2006 - Match flame equivalent, EN 1022:2005, EN 16139:2013 (L2), EN ISO 6941:2003

Model P2226



The Spanish Chair Accessories Complete leather set for 2226

Designed by Børge Mogensen

Complete leather set for The Spanish Chair with interchangeable seat and back made in vegetable tanned saddle leather with metal buckles. Leather seat has canvas backing. Saddle straps can be tightened as the leather expands through use.

Order configuration

	Natural leather	Black leather	Cognac leather	Dark Brown leather
	2,570	1.855	1.855	1.855

Model 1710

Spine Lounge Chair



Designed by Space Copenhagen, 2016

Lounge chair with legs of solid wood. Wooden seat shell of moulded plywood. The cushion in HR or CMHR foam. Available in fabric or leather, with piping in all stitches. Cushions are kept in place with Velcro fixtures and are removable for cleaning. Cover is removable.

Modeldetails

0,56 m³ Packaging dimensions:
45 kg / 34 kg L: 86 cm W: 86 cm H: 76 cm

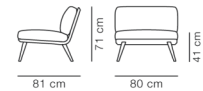

Essential Assortment

Pre-configured

Item number	Upholstery	Wood	Price
171020200044807	Grand Linen Naturel 0024	Oak lacquer, FSC Mix 70%	4.225
171022300050088	Leather Primo 88, Black	Black ash, FSC Mix 70%	4.435
171022300050841	Leather Cera 905, Russet brown	Black ash, FSC Mix 70%	5.305

Essential variants only delivered with HR foam

Order configuration

	Oak lacquered	Black ash	Smoked oak stained, lacquered
Fabric group 0	3.930	3.535	4.150
Fabric group 1	4.225	3.805	4.645
Fabric group 2	4.435	4.015	4.880
Fabric group 3	4.770	4.350	4.965
Fabric group 4	5.330	4.910	5.525
Fabric group 5	5.785	5.365	5.980
C.O.M. fabric	4.225	3.805	4.420
Leather group 0	4.130	3.735	4.355
Leather group 1	4.440	4.020	4.635
Leather group 2	4.855	4.435	5.050
Leather group 3	5.245	4.820	5.435
Leather group 4	5.765	5.305	5.920
Leather group 5	6.635	6.100	6.715
C.O.M. leather	4.440	4.020	4.635

Fabric consumption: 2,9 m. Leather consumption: 5 m²

QuickClick glides with felt upon request (R1730).

Certifications

FSC® certified

EN 1022:2005, EN 16139:2013 (L2)

Recommended upholstery

Fabric group 1	Gran Linen, Linara, Bardal, Capture, Remix, Re-wool, Natural Linen, Erik
Fabric group 2	Savoy, Barnum, Steelcut Trio, Fiord, Hallingdal, Ruskin, Loop
Fabric group 3	Vidar, Clay, Sunniva, Divina Melange
Fabric group 4	Sisu, Safire, Cotil, Elle
Fabric group 5	Gentle, Grand Mohair
Leather group 0	Vice
Leather group 1	Omni
Leather group 2	Primo, Trace
Leather group 3	Max
Leather group 4	Nubuck, Organic, Vegeta, Cera

Model 1711

Spine Lounge Chair Petit



Designed by Space Copenhagen, 2016

Lounge chair with legs of solid wood. Wooden seat shell of moulded plywood. Cushions in HR or CMHR foam. Available in fabric or leather, with piping in all stitches. Cushions are kept in place with Velcro fixtures and are removable for cleaning. Cover is removable.

Modeldetails

0,38 m³ Packaging dimensions:
29 kg / 24 kg L: 76 cm W: 70 cm H: 72 cm

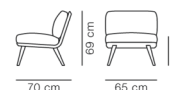

Essential Assortment

Pre-configured

Item number	Upholstery	Wood	Price
171122350088000	Leather Primo 88, Black	Black ash, FSC Mix 70%	2.805
171120244807000	Grand Linen Naturel 0024	Oak lacquer, FSC Mix 70%	2.825
171122350841000	Leather Cera 905, Russet brown	Black ash, FSC Mix 70%	3.550

Essential variants only delivered with HR foam

Order configuration

	Oak lacquered	Black ash	Smoked oak stained, lacquered
Fabric group 0	2.630	2.170	2.545
Fabric group 1	2.825	2.335	2.710
Fabric group 2	2.975	2.480	2.855
Fabric group 3	3.160	2.665	3.040
Fabric group 4	3.390	2.895	3.270
Fabric group 5	3.775	3.285	3.655
C.O.M. fabric	2.825	2.335	2.710
Leather group 0	2.750	2.305	2.680
Leather group 1	2.955	2.480	2.855
Leather group 2	3.280	2.805	3.180
Leather group 3	3.705	3.230	3.605
Leather group 4	4.075	3.550	3.925
Leather group 5	4.685	4.085	4.460
C.O.M. leather	2.955	2.480	2.855

Fabric consumption: 2,7 m. Leather consumption: 4,2 m²

Extra charge for

QuickClick glides with or without felt: +12

Certifications

FSC® certified
EN 1022:2005, EN 16139:2013 (L2)

Recommended upholstery

Fabric group 1	Gran Linen, Linara, Bardal, Capture, Remix, Re-wool, Natural Linen, Erik
Fabric group 2	Savoy, Barnum, Steelcut Trio, Fiord, Hallingdal, Ruskin, Loop
Fabric group 3	Vidar, Clay, Sunniva, Divina Melange
Fabric group 4	Sisu, Safire, Cotil, Elle
Fabric group 5	Gentle, Grand Mohair
Leather group 0	Vice
Leather group 1	Omni
Leather group 2	Primo, Trace
Leather group 3	Max
Leather group 4	Nubuck, Organic, Vegeta, Cera

Model 1770

Swoon Lounge Armchair Wood base



Designed by Space Copenhagen, 2016

Fully upholstered lounge chair with solid wood legs mounted with metal thread. Inner shell in moulded cold cured foam in HR or CMHR foam, reinforced with a steel frame. Removable seat and back cushion of foam, with removable cover. External cover is non-removable. Available in fabric or leather.

Modeldetails

0,93 m³ Packaging dimensions:
32,8 kg / L: 94 cm W: 94 cm H: 105 cm
18,6 kg

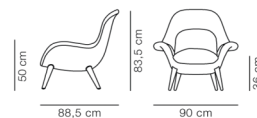

Essential Assortment

Pre-configured

Item number	Upholstery	Legs	Price
17700772200005202000	Sunniva 242	Oak lacquer, FSC Mix 70%	3.245
17700773900005162000	Sunniva 717	Walnut lacquer	3.245
17700774500005224000	Sunniva 192	Oak black lacquer FSC Mix 70%	3.245
17700167500005202000	Elle 230	Oak lacquer, FSC Mix 70%	3.670

Essential variants only delivered with HR foam

Order configuration

Legs: Walnut lacquered, oak lacquered, oak oiled, smoked oak stained lacquered or oak black lacquered.

Fabric group 0	2.360
Fabric group 1	2.535
Fabric group 2	3.025
Fabric group 3	3.245
Fabric group 4	3.670
Fabric group 5	4.220
C.O.M. fabric	2.535
Leather group 1	3.380
Leather group 2	3.980
Leather group 3	4.505
Leather group 4	5.050
Leather group 5	5.810
C.O.M. leather	3.380

Fabric consumption: 4,4 m. Leather consumption: 8 m²

Different fabrics on corpus and cushion upon request.

Certifications

Oak is FSC® certified

EN 1022:2005, EN 16139:2013 (L2), ANSI/BIFMA X7.1/M7.1/e3-2019 VOC test (tested with HR foam and EU Ecolabel fabric)

Recommended upholstery

Fabric group 0	Connect
Fabric group 1	Capture, Re-wool, Linara, Bardal, Remix, Erik
Fabric group 2	Steelcut Trio, Ruskin, Barnum, Fiord, Savoy, Hallingdal, Loop
Fabric group 3	Sunniva, Divina Melange, Vidar, Clay
Fabric group 4	Safire, Sisu, Elle
Fabric group 5	Grand Mohair, Gentle
Leather group 1	Omni
Leather group 2	Primo, Trace
Leather group 3	Max
Leather group 4	Vegeta, Nubuck, Organic

Model 1771

Swoon Ottoman Wood base



Designed by Space Copenhagen, 2018

Fully upholstered footstool with solid wood legs mounted with metal thread. Inner shell in moulded cold cured foam in HR or CMHR foam, reinforced with a steel frame. Available in fabric or leather. Cover is non-removable.

Modeldetails

0,15 m³ Packaging dimensions:
13 kg / 9,5 kg L: 55 cm W: 65 cm H: 48 cm



Essential Assortment

Pre-configured

Item number	Upholstery	Legs	Price
17710772200005202000	Sunniva 242	Oak lacquer, FSC Mix 70%	1.085
17710773900005162000	Sunniva 717	Walnut lacquer	1.085
17710774500005224000	Sunniva 192	Oak black lacquer FSC Mix 70%	1.085
17710167500005202000	Elle 230	Oak lacquer, FSC Mix 70%	1.215

Essential variants only delivered with HR foam

Order configuration

Legs: Walnut lacquered, oak lacquered, oak oiled, smoked oak stained lacquered or oak black lacquered.

Fabric group 0	870
Fabric group 1	940
Fabric group 2	1.025
Fabric group 3	1.085
Fabric group 4	1.215
Fabric group 5	1.385
C.O.M. fabric	940
Leather group 1	1.445
Leather group 2	1.640
Leather group 3	1.845
Leather group 4	2.055
Leather group 5	2.365
C.O.M. leather	1.445

Fabric consumption: 2 m. Leather consumption: 2,5 m²

Certifications

Oak is FSC® certified

EN 1022:2005, EN 16139:2013 (L2), ANSI/BIFMA X7.1/M7.1/e3-2019 VOC test (tested with HR foam and EU Ecolabel fabric)

Recommended upholstery

Fabric group 0	Connect
Fabric group 1	Capture, Re-wool, Linara, Bardal, Remix, Erik
Fabric group 2	Steelcut Trio, Ruskin, Barnum, Fiord, Savoy, Hallingdal, Loop
Fabric group 3	Sunniva, Divina Melange, Vidar, Clay
Fabric group 4	Safire, Sisu, Elle
Fabric group 5	Grand Mohair, Gentle
Leather group 1	Omni
Leather group 2	Primo, Trace
Leather group 3	Max
Leather group 4	Vegeta, Nubuck, Organic

Model 1774

Swoon Lounge Petit Armchair Wood base



Designed by Space Copenhagen, 2019

Fully upholstered lounge chair with solid wood legs mounted with metal thread. Inner shell in moulded cold cured foam in HR or CMHR foam, reinforced with a steel frame. Removable seat and back cushion of foam, with removable cover. External cover is non-removable. Available in fabric or leather.

Modeldetails

0,61 m³ Packaging dimensions:
19 kg / L: 82 cm W: 84 cm H: 89 cm
13,5 kg

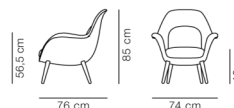

Essential Assortment

Pre-configured

Item number	Upholstery	Legs	Price
17740772200005202000	Sunniva 242	Oak lacquer, FSC Mix 70%	2.615
17740773900005162000	Sunniva 717	Walnut lacquer	2.615
17740774500005224000	Sunniva 192	Oak black lacquer FSC Mix 70%	2.615
17740167500005202000	Elle 230	Oak lacquer, FSC Mix 70%	3.045

Essential variants only delivered with HR foam

Order configuration

Legs: Walnut lacquered, oak lacquered, oak oiled, smoked oak stained lacquered or oak black lacquered.

Fabric group 0	1.995
Fabric group 1	2.145
Fabric group 2	2.390
Fabric group 3	2.615
Fabric group 4	3.045
Fabric group 5	3.605
C.O.M. fabric	2.145
Leather group 1	2.415
Leather group 2	2.780
Leather group 3	3.095
Leather group 4	3.430
Leather group 5	3.945
C.O.M. leather	2.415

Fabric consumption: 3,9 m. Leather consumption: 6,5 m²

Different fabrics on corpus and cushion upon request.

Certifications

Oak is FSC® certified

EN 1022:2005, EN 16139:2013 (L2), ANSI/BIFMA X7.1/M7.1/e3-2019 VOC test (tested with HR foam and EU Ecolabel fabric)

Recommended upholstery

Fabric group 0	Connect
Fabric group 1	Capture, Re-wool, Bardal, Linara, Remix, Erik
Fabric group 2	Savoy, Barnum, Fiord, Steelcut Trio, Hallingdal, Loop, Ruskin
Fabric group 3	Sunniva, Vidar, Clay, Divina Melange
Fabric group 4	Safire, Sisu, Elle
Fabric group 5	Gentle, Grand Mohair
Leather group 1	Omni
Leather group 2	Primo, Trace
Leather group 3	Max
Leather group 4	Vegeta, Nubuck, Organic

Model 1776

Swoon Lounge Petit Armchair Swivel base



Designed by Space Copenhagen, 2019

Fully upholstered lounge chair with aluminum swivel base. Inner shell in moulded cold cured foam in HR or CMHR foam, reinforced with a steel frame. Removable seat and back cushion of foam, with removable cover. External cover is non-removable. Available in fabric or leather. Mounted with reversible plastic glides which can be changed to felt when reversed.

Modeldetails

0,61 m³ Packaging dimensions:
30 kg / 18 kg L: 82 cm W: 84 cm H: 89 cm



Essential Assortment

Pre-configured

Item number	Upholstery	Frame	Price
17760772200005905072	Sunniva 242	Swivel base polished aluminium	2.865
17760773900005451071	Sunniva 717	Swivel base black	2.865
17760774500005451071	Sunniva 192	Swivel base black	2.865
17760167500005905072	Elle 230	Swivel base polished aluminium	3.295

Essential variants only delivered with HR foam

Order configuration

Frame: Polished aluminium or black.

Fabric group 0	2.225
Fabric group 1	2.395
Fabric group 2	2.640
Fabric group 3	2.865
Fabric group 4	3.295
Fabric group 5	3.855
C.O.M. fabric	2.395
Leather group 1	2.705
Leather group 2	3.070
Leather group 3	3.385
Leather group 4	3.715
Leather group 5	4.275
C.O.M. leather	2.705

Fabric consumption: 3,9 m. Leather consumption: 6,5 m²

Different fabrics on corpus and cushion upon request.

Certifications

EN 1022:2005, EN 16139:2013 (L2), ANSI/BIFMA X7.1/M7.1/e3-2019 VOC test (tested with HR foam and EU Ecolabel fabric)

Recommended upholstery

Fabric group 0	Connect
Fabric group 1	Capture, Re-wool, Bardal, Linara, Remix, Erik
Fabric group 2	Savoy, Barnum, Fiord, Steelcut Trio, Hallingdal, Loop, Ruskin
Fabric group 3	Sunniva, Vidar, Clay, Divina Melange
Fabric group 4	Safire, Sisu, Elle
Fabric group 5	Gentle, Grand Mohair
Leather group 1	Omni
Leather group 2	Primo, Trace
Leather group 3	Max
Leather group 4	Vegeta, Nubuck, Organic

Model 1788

Wegner 1788 Lounge Chair



Designed by Hans J. Wegner, 1974

Easy chair with frame of solid wood. Seat supported by jute webbing. Interchangeable seat and back cushions of HR foam, covered in fabric or leather and finished with buttons. Back cushion attached with leather straps. Available in fabric or leather.

Modeldetails

0,45 m³ Packaging dimensions:
15 kg / 10 kg L: 70 cm W: 70 cm H: 92 cm

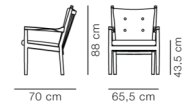

Essential Assortment

Pre-configured

Item number	Upholstery	Wood	Price
17882031410830	Capture 4201	Oak soap, FSC Mix 70%	3.160
17882031411230	Capture 5201	Oak soap, FSC Mix 70%	3.160
17882034480630	Natural Linen 0003	Oak soap, FSC Mix 70%	3.160
17880055130130	Leather Omni 301, Black	Black lacquered	3.175
17882035009530	Leather Max 95, Cognac	Oak soap, FSC Mix 70%	3.470
17882030095030	Cotil 863, 53938	Oak soap, FSC Mix 70%	3.520

Essential variants only delivered with HR foam

Order configuration

	Oak soap	Oak oiled	Oak black lacquered
Fabric group 1	3.160	3.375	3.160
Fabric group 2	3.255	3.465	3.255
Fabric group 3	3.375	3.585	3.375
Fabric group 4	3.520	3.730	3.520
Fabric group 5	4.225	4.435	4.225
C.O.M. fabric	3.160	3.375	3.160
Leather group 1	3.175	3.385	3.175
Leather group 2	3.305	3.515	3.305
Leather group 3	3.470	3.685	3.470
Leather group 4	3.820	4.030	3.820
Leather group 5	4.395	4.605	4.395
C.O.M. leather	3.175	3.385	3.175

Fabric consumption: 1,3 m. Leather consumption: 4,2 m²

Extra charge for

QuickClick glides with or without felt (R1788): +12

Certifications

Oak is FSC® certified
EN 1022:2005, EN 16139:2013 (L2)

Recommended upholstery

Fabric group 1	Gran Linen, Remix, Capture, Bardal, Re-wool, Linara, Natural Linen, Erik
Fabric group 2	Hallingdal, Barnum, Steelcut Trio, Fiord, Ruskin, Savoy
Fabric group 3	Divina Melange, Vidar, Sunniva, Clay
Fabric group 4	Cotil, Sisu, Elle, Safire
Fabric group 5	Gentle
Leather group 1	Omni
Leather group 2	Primo, Trace
Leather group 3	Max
Leather group 4	Organic, Nubuck, Vegeta, Cera

Model P1788



Wegner 1788 Accessories Cushions for 1788

Designed by Hans J. Wegner

Cushions for Wegner 1788 easy chair. Consists of seat and back cushions of HR foam, covered in fabric or leather and finished with buttons. Back cushion attached with leather straps. Available in fabric or leather.

Order configuration

Fabric group 1	900
Fabric group 2	985
Fabric group 3	1.095
Fabric group 4	1.235
Fabric group 5	1.480
C.O.M. fabric	900
Leather group 1	915
Leather group 2	1.035
Leather group 3	1.190
Leather group 4	1.305
Leather group 5	1.505
C.O.M. leather	915

Fabric consumption: 1,3 m. Leather consumption: 4,2 m²

Recommended upholstery

Fabric group 1	Gran Linen, Natural Linen, Erik, Linara, Bardal, Capture, Remix, Re-wool
Fabric group 2	Savoy, Barnum, Steelcut Trio, Fiord, Hallingdal, Ruskin
Fabric group 3	Vidar, Clay, Sunniva, Divina Melange
Fabric group 4	Sisu, Safire, Elle, Cotil
Fabric group 5	Gentle
Leather group 1	Omni
Leather group 2	Primo, Trace
Leather group 3	Max
Leather group 4	Nubuck, Vegeta, Organic, Cera

Model 16000



Wegner J16 Rocking Chair

Designed by Hans J. Wegner, 1944

Rocking chair in solid wood. Woven seat of paper cord.

Modeldetails

0,58 m³ Packaging dimensions:
13 kg / 11 kg L: 79 cm W: 65 cm H: 113 cm

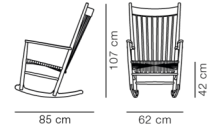

Essential Assortment

Pre-configured

Item number	Seat	Wood	Price
1600020325000000	Natural paper cord	Oak soap, FSC Mix 70%	2.460
1600022425000000	Natural paper cord	Oak black lacquer, FSC Mix 70%	2.460
1600020525000000	Natural paper cord	Oak oil, FSC Mix 70%	2.460
1600022426000000	Black paper cord	Oak black lacquer, FSC Mix 70%	2.830
1600016425000000	Natural paper cord	Walnut oiled	3.075

Certifications

Oak is FSC® certified

EN 1022:2005, EN 16139:2013 (L1)

Model P1600H



Wegner J16 Accessories Cushions for J16

Designed by Hans J. Wegner

Cushions for Wegner J16 Rocking Chair. Loose seat, back or neck cushions in HR foam with a back of granulated foam.

Essential Assortment

Pre-configured

Item number	Type	Upholstery	Price
P1600H03448060	Seat cushion with cover	Natural Linen 0003	275
P1600H13448060	Neck cushion with	Natural Linen 0003	335
P1600H03513010	Seat cushion with cover	Leather Omni 301, Black	380
P1600H03513070	Seat cushion with cover	Leather Omni 307, Cognac	380
P1600H04448060	Back cushion with cover	Natural Linen 0003	405
P1600H13513010	Neck cushion with	Leather Omni 301, Black	430
P1600H13513070	Neck cushion with	Leather Omni 307, Cognac	430
P1600H04513010	Back cushion with cover	Leather Omni 301, Black	545
P1600H04513070	Back cushion with cover	Leather Omni 307, Cognac	545

Essential variants only delivered with HR foam

Order configuration

	Neck cushion	Back cushion	Seat cushion
Fabric group 1	335	405	275
Fabric group 2	350	440	290
Fabric group 3	370	505	320
Fabric group 4	420	600	370
Fabric group 5	535	835	485
C.O.M. fabric	335	405	275
Leather group 1	430	545	380
Leather group 2	480	630	420
Leather group 3	555	760	480
Leather group 4	665	945	565
Leather group 5	850	1.255	715
C.O.M. leather	430	545	380

Recommended upholstery

Fabric group 1	Remix, Capture, Bardal, Re-wool, Linara, Erik, Gran Linen, Natural Linen
Fabric group 2	Ruskin, Barnum, Steelcut Trio, Fiord, Hallingdal, Loop
Fabric group 3	Vidar, Sunniva, Divina Melange, Clay
Fabric group 4	Sisu, Cotil, Elle, Safire
Fabric group 5	Gentle
Leather group 0	Vice
Leather group 1	Omni
Leather group 2	Primo, Trace
Leather group 3	Max
Leather group 4	Nubuck, Vegeta, Organic, Cera

Model 16002

Wegner J16 Stool



Designed by Hans J. Wegner, 1950

Footstool in solid wood. Woven seat of paper cord.

Modeldetails

0,1 m³

Packaging dimensions:

5 kg /
4 kg

L: 56 cm W: 40 cm H: 46 cm

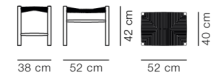

Essential Assortment

Pre-configured

Item number	Seat	Wood	Price
1600220325000000	Natural paper cord	Oak soap, FSC Mix 70%	795
1600222425000000	Natural paper cord	Oak black lacquer, FSC Mix 70%	795
1600220525000000	Natural paper cord	Oak oil, FSC Mix 70%	795
1600216425000000	Natural paper cord	Walnut oiled	920
1600222426000000	Black paper cord	Oak black lacquer, FSC Mix 70%	1.005

Extra charge for

QuickClick glides with or without felt (R16002):

+12

Certifications

Oak is FSC® certified

Model P16002

Wegner J16 Accessories Cushion for J16 Stool

Designed by Hans J. Wegner

Cushions for Wegner J16 Rocking Chair. Loose cushions in foam.

Order configuration

	Cushion
Fabric group 1	275
Fabric group 2	295
Fabric group 3	320
Fabric group 4	345
Fabric group 5	415
C.O.M. fabric	275
Leather group 1	290
Leather group 2	355
Leather group 3	430
Leather group 4	470
Leather group 5	540
C.O.M. leather	290

Fabric consumption: 0,6 m. Leather consumption: 0,84 m²

Recommended upholstery

Fabric group 1	Natural Linen, Re-wool, Remix, Capture, Bardal, Linara, Erik, Gran Linen
Fabric group 2	Steelcut Trio, Fiord, Hallingdal, Ruskin, Barnum, Loop
Fabric group 3	Sunniva, Divina Melange, Vidar, Clay
Fabric group 4	Sisu, Cotil, Elle, Safire
Fabric group 5	Gentle
Leather group 1	Omni
Leather group 2	Primo, Trace
Leather group 3	Max
Leather group 4	Nubuck, Vegeta, Organic, Cera

Model 1000





Wegner Ox Chair Easy chair

Designed by Hans J. Wegner, 1960

Fully upholstered easy chair in fabric or leather. Inner frame of solid wood and moulded cold cured foam. Pads at neck and armrest includes piping, available in leather as contrast to fabric upholstery. Cover is non-removable. Stainless steel base. Mounted with plastic glides.

Modeldetails

 1,1 m³ Packaging dimensions:
 73 kg / 31 kg L: 103 cm W: 97 cm H: 117 cm

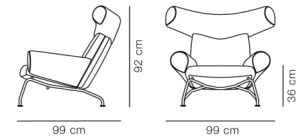

Essential Assortment

Pre-configured

Item number	Upholstery	Piping	Frame	Price
1000002680900260100	Hallingdal 116	Leather Max 95, Cognac	Brushed stainless steel	8.165
1000500880909060100	Leather Primo 88, Black	Piping as upholstery	Brushed stainless steel	10.645
1000508410909060100	Leather Cera 905, Russet brown	Piping as upholstery	Brushed stainless steel	13.125

Essential variants only delivered with HR foam

Order configuration

	Black	Brushed stainless steel
Fabric group 1	7.880	7.880
Fabric group 2	8.165	8.165
Fabric group 3	8.440	8.440
Fabric group 4	8.870	8.870
Fabric group 5	9.890	9.890
C.O.M. fabric	7.880	7.880
Leather group 2	10.645	10.645
Leather group 3	11.670	11.670
Leather group 4	13.125	13.125
Leather group 5	15.385	15.385
C.O.M. leather	10.525	10.525

Fabric consumption: 4,5 m. Leather consumption: 13 m²

Not available in Trace leather.

Extra charge for

Leather piping for furniture with fabric:	+100
Pads for arm and horn in leather for furniture with fabric:	+80

Certifications

EN 1022:2005, EN 16139:2013 (L2)

Recommended upholstery

Fabric group 1	Linara, Bardal, Capture, Re-wool, Erik
Fabric group 2	Barnum, Steelcut Trio, Fiord, Hallingdal, Ruskin
Fabric group 3	Vidar, Clay, Sunniva, Divina Melange
Leather group 2	Primo
Leather group 3	Max
Leather group 4	Nubuck, Vegeta, Organic, Cera

Model 1002

Wegner Ox Ottoman



Designed by Hans J. Wegner, 1960

Fully upholstered footstool in fabric or leather for Ox Chair and Queen Chair. Inner frame of solid wood and moulded cold cured foam. Side pads available in leather as contrast to fabric upholstery. Cover is non-removable. Stainless steel base. Mounted with plastic glides.

Modeldetails

0,17 m³ Packaging dimensions:
13 kg / 11 kg L: 80 cm W: 56 cm H: 38 cm

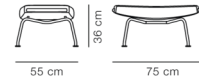

Essential Assortment

Pre-configured

Item number	Upholstery	Frame	Price
1002002680900060100	Hallingdal 116	Brushed stainless steel	2.100
1002500880900060100	Leather Primo 88, Black	Brushed stainless steel	2.920
1002508410900060100	Leather Cera 905, Russet brown	Brushed stainless steel	3.715

Essential variants only delivered with HR foam

Order configuration

	Black	Brushed stainless steel
Fabric group 1	2.050	2.050
Fabric group 2	2.100	2.100
Fabric group 3	2.145	2.145
Fabric group 4	2.215	2.215
Fabric group 5	2.385	2.385
C.O.M. fabric	2.050	2.050
Leather group 2	2.920	2.920
Leather group 3	3.255	3.255
Leather group 4	3.715	3.715
Leather group 5	4.510	4.510
C.O.M. leather	2.860	2.860

Fabric consumption: 0,9 m. Leather consumption: 4,5 m²

Not available in Trace leather.

Extra charge for

Side pads in leather for furniture with fabric: +80

Recommended upholstery

Fabric group 1	Linara, Bardal, Capture, Re-wool, Erik
Fabric group 2	Barnum, Steelcut Trio, Fiord, Hallingdal, Ruskin
Fabric group 3	Vidar, Clay, Sunniva, Divina Melange
Leather group 2	Primo
Leather group 3	Max
Leather group 4	Nubuck, Vegeta, Organic, Cera

Model 1010

Wegner Queen Chair Easy chair



Designed by Hans J. Wegner, 1960

Fully upholstered easy chair in fabric or leather. Inner frame of solid wood and moulded cold cured foam. Piping at backrest and arm pads available in leather as contrast to fabric upholstery. Cover is non-removable. Stainless steel base. Mounted with plastic glides.

Modeldetails

1,1 m³ Packaging dimensions:
 71 kg / 28 kg L: 103 cm W: 97 cm H: 117 cm

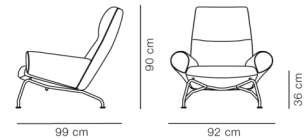

Essential Assortment

Pre-configured

Item number	Upholstery	Piping	Frame	Price
1010002680900260100	Hallingdal 116	Leather Max 95, Cognac	Brushed stainless steel	6.920
1010500880909060100	Leather Primo 88, Black	Piping as upholstery	Brushed stainless steel	8.485
1010508410909060100	Leather Cera 905, Russet brown	Piping as upholstery	Brushed stainless steel	10.300

Essential variants only delivered with HR foam

Order configuration

	Black	Brushed stainless steel
Fabric group 1	6.730	6.730
Fabric group 2	6.920	6.920
Fabric group 3	7.100	7.100
Fabric group 4	7.365	7.365
Fabric group 5	8.010	8.010
C.O.M. fabric	6.730	6.730
Leather group 2	8.485	8.485
Leather group 3	9.275	9.275
Leather group 4	10.300	10.300
Leather group 5	11.975	11.975
C.O.M. leather	8.365	8.365

Fabric consumption: 3,8 m. Leather consumption: 9,5 m²

Not available in Trace leather.

Extra charge for

Leather piping for furniture with fabric:	+100
Arm pads in leather for furniture with fabric:	+55

Certifications

EN 1022:2005, EN 16139:2013 (L2)

Recommended upholstery

Fabric group 1	Linara, Bardal, Capture, Re-wool, Erik
Fabric group 2	Barnum, Steelcut Trio, Fiord, Hallingdal, Ruskin
Fabric group 3	Vidar, Clay, Sunniva, Divina Melange
Leather group 2	Primo
Leather group 3	Max
Leather group 4	Nubuck, Vegeta, Organic, Cera

Model P1010

Wegner Queen Accessories Neck cushion



Designed by Hans J. Wegner, 1960

Removable neck cushion for Wegner Queen Chair. Available in leather only.

Essential Assortment

Pre-configured

Item number	Upholstery	Price
P1010500880001801	Leather Primo 88, Black	410

Essential variants only delivered with HR foam

Order configuration

Leather group 2	410
Leather group 3	465
Leather group 4	495
Leather group 5	570
C.O.M. leather	375

Leather consumption: 0,5 m²

Recommended upholstery

Leather group 2	Primo
Leather group 3	Max
Leather group 4	Nubuck, Vegeta, Organic, Cera

Sofas

Model 5622

Calmo Sofa 170 cm, 2 seater



Designed by Hugo Passos, 2019

Sofa with separate seat and back cushions, width 80 cm. Inner frame of wood with nozag springs. Available in fabric or leather. Cushions available in foam core with down wrap or solid foam, either HR or CMHR foam. Cushions in fabric are reversible. External cover is non-removable. Cushion covers are removable. Leg trestles in solid wood or steel. Mounted with plastic glides. Felt glides available.

Modeldetails

1,06 m³ Packaging dimensions:
71 kg / 58 kg L: 174 cm W: 94 cm H: 65 cm

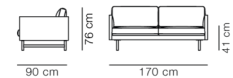

Essential Assortment

Pre-configured

Item number	Upholstery	Frame	Price
5622028019311040046	Re-Wool 128	Black	4.245
5622028019311085446	Re-Wool 128	Oak lacquer, FSC Mix 70%	4.245
5622028007739040046	Sunniva 717	Black	5.135
5622028007739085446	Sunniva 717	Oak lacquer, FSC Mix 70%	5.135

Essential variants are delivered with plastic glides and HR foam core with down wrap

Order configuration

	Oak lacquered	Smoked oak stained, lacquered	Metal black	Matt chrome
Fabric group 1	4.245	4.245	4.245	4.245
Fabric group 2	4.550	4.550	4.550	4.550
Fabric group 3	5.135	5.135	5.135	5.135
Fabric group 4	6.015	6.015	6.015	6.015
Fabric group 5	7.155	7.155	7.155	7.155
C.O.M. fabric	4.245	4.245	4.245	4.245
Leather group 1	5.440	5.440	5.440	5.440
Leather group 2	6.850	6.850	6.850	6.850
Leather group 3	8.155	8.155	8.155	8.155
Leather group 4	8.970	8.970	8.970	8.970
Leather group 5	10.320	10.320	10.320	10.320
C.O.M. leather	5.440	5.440	5.440	5.440

Fabric consumption: 7,43 m. Leather consumption: 16,5 m²

Note - Complementary cushions are ordered separately (P5522).

Certifications

FSC® certified

EN 1022:2005, EN 16139:2013 (L2)

Recommended upholstery

Fabric group 1	Gran Linen, Remix, Capture, Bardal, Re-wool, Linara, Natural Linen, Erik
Fabric group 2	Hallingdal, Barnum, Loop, Steelcut Trio, Fiord, Ruskin, Savoy
Fabric group 3	Divina Melange, Vidar, Sunniva, Clay
Fabric group 4	Elle, Sisu, Safire
Fabric group 5	Gentle
Leather group 1	Omni
Leather group 2	Primo, Trace
Leather group 3	Max
Leather group 4	Nubuck, Organic, Vegeta, Cera

Model 5652

Calmo Sofa 200 cm, 2½ seater



Designed by Hugo Passos, 2019

Sofa with separate seat and back cushions, width 95 cm. Inner frame of wood with nozag springs. Available in fabric or leather. Cushions available in foam core with down wrap or solid foam, either HR or CMHR foam. Cushions in fabric are reversible. External cover is non-removable. Cushion covers are removable. Leg trestles in solid wood or steel. Mounted with plastic glides. Felt glides available.

Modeldetails

1,2 m³ Packaging dimensions:
83 kg / 64 kg L: 202 cm W: 93 cm H: 64 cm

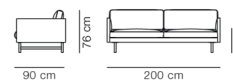

Essential Assortment

Pre-configured

Item number	Upholstery	Frame	Price
5652029519311040046	Re-Wool 128	Black	4.465
5652029519311085446	Re-Wool 128	Oak lacquer, FSC Mix 70%	4.465
5652029507722040046	Sunniva 242	Black	5.595
5652029507722085446	Sunniva 242	Oak lacquer, FSC Mix 70%	5.595
5652029507739040046	Sunniva 717	Black	5.595
5652029507739085446	Sunniva 717	Oak lacquer, FSC Mix 70%	5.595
5652029507878040046	Sunniva 783	Black	5.595
5652029507878085446	Sunniva 783	Oak lacquer, FSC Mix 70%	5.595

Essential variants are delivered with plastic glides and HR foam core with down wrap

Order configuration

	Oak lacquered	Smoked oak stained, lacquered	Metal black	Matt chrome
Fabric group 1	4.465	4.465	4.465	4.465
Fabric group 2	4.985	4.985	4.985	4.985
Fabric group 3	5.595	5.595	5.595	5.595
Fabric group 4	6.635	6.635	6.635	6.635
Fabric group 5	7.970	7.970	7.970	7.970
C.O.M. fabric	4.465	4.465	4.465	4.465
Leather group 1	5.950	5.950	5.950	5.950
Leather group 2	7.610	7.610	7.610	7.610
Leather group 3	9.150	9.150	9.150	9.150
Leather group 4	10.065	10.065	10.065	10.065
Leather group 5	11.575	11.575	11.575	11.575
C.O.M. leather	5.950	5.950	5.950	5.950

Fabric consumption: 8,32 m. Leather consumption: 20 m²

Note - Complementary cushions are ordered separately (P5522).

Certifications

FSC® certified

EN 1022:2005, EN 16139:2013 (L2)



Recommended upholstery

Fabric group 1	Gran Linen, Remix, Erik, Capture, Bardal, Re-wool, Linara, Natural Linen
Fabric group 2	Hallingdal, Barnum, Loop, Steelcut Trio, Fiord, Ruskin, Savoy
Fabric group 3	Divina Melange, Vidar, Sunniva, Clay
Fabric group 4	Elle, Sisu, Safire
Fabric group 5	Gentle
Leather group 1	Omni
Leather group 2	Primo, Trace
Leather group 3	Max
Leather group 4	Nubuck, Organic, Vegeta, Cera

Model 5623

Calmo Sofa 250 cm, 3 seater

Modeldetails

 1,5 m³ Packaging dimensions:
 98 kg / 77 kg L: 252 cm W: 93 cm H: 64 cm

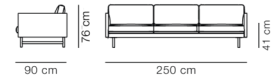

Designed by Hugo Passos, 2019

Sofa with separate seat and back cushions, width 80 cm. Inner frame of wood with nozag springs. Available in fabric or leather. Cushions available in foam core with down wrap or solid foam, either HR or CMHR foam. Cushions in fabric are reversible. External cover is non-removable. Cushion covers are removable. Leg trestles in solid wood or steel. Mounted with plastic glides. Felt glides available.

Essential Assortment

Pre-configured

Item number	Upholstery	Frame	Price
5623038019311040046	Re-Wool 128	Black	5.355
5623038019311085446	Re-Wool 128	Oak lacquer, FSC Mix 70%	5.355
5623038007722040046	Sunniva 242	Black	6.405
5623038007722085446	Sunniva 242	Oak lacquer, FSC Mix 70%	6.405
5623038007739040046	Sunniva 717	Black	6.405
5623038007739085446	Sunniva 717	Oak lacquer, FSC Mix 70%	6.405
5623038007878040046	Sunniva 783	Black	6.405
5623038007878085446	Sunniva 783	Oak lacquer, FSC Mix 70%	6.405

Essential variants are delivered with plastic glides and HR foam core with down wrap

Order configuration

	Oak lacquered	Smoked oak stained, lacquered	Metal black	Matt chrome
Fabric group 1	5.355	5.355	5.355	5.355
Fabric group 2	5.655	5.655	5.655	5.655
Fabric group 3	6.405	6.405	6.405	6.405
Fabric group 4	7.530	7.530	7.530	7.530
Fabric group 5	8.980	8.980	8.980	8.980
C.O.M. fabric	5.355	5.355	5.355	5.355
Leather group 1	6.790	6.790	6.790	6.790
Leather group 2	8.590	8.590	8.590	8.590
Leather group 3	10.260	10.260	10.260	10.260
Leather group 4	11.285	11.285	11.285	11.285
Leather group 5	12.980	12.980	12.980	12.980
C.O.M. leather	6.790	6.790	6.790	6.790

Fabric consumption: 10,2 m. Leather consumption: 29,5 m²

Note - Complementary cushions are ordered separately (P5522).

Certifications

FSC® certified

EN 1022:2005, EN 16139:2013 (L2)

Recommended upholstery

Fabric group 1	Gran Linen, Remix, Capture, Bardal, Re-wool, Linara, Natural Linen, Erik
Fabric group 2	Hallingdal, Barnum, Loop, Steelcut Trio, Fiord, Ruskin, Savoy
Fabric group 3	Divina Melange, Vidar, Sunniva, Clay
Fabric group 4	Elle, Sisu, Safire
Fabric group 5	Gentle
Leather group 1	Omni
Leather group 2	Primo, Trace
Leather group 3	Max
Leather group 4	Nubuck, Organic, Vegeta, Cera

Model 5625

Calmo Chaise Sofa 250 cm, 3 seater, Chaise L or R

Modeldetails

2,1 m³ Packaging dimensions:
118 kg / 93 kg L: 252/96 cm W: 93/68 cm H: 64/45 cm



Designed by Hugo Passos, 2019

Sofa with separate seat and back cushions, width 80 cm. Inner frame of wood with nozag springs. Available in fabric or leather. Cushions available in foam core with down wrap or solid foam, either HR or CMHR foam. Cushions in fabric are reversible. External cover is non-removable. Cushion covers are removable. Leg trestles in solid wood or steel. The placement of the chaise lounge can be changed on the spot using a standard hex key. Mounted with plastic glides. Felt glides available.

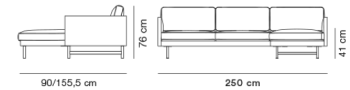

Order configuration

	Oak lacquered	Smoked oak stained, lacquered	Metal black	Matt chrome
Fabric group 1	6.370	6.370	6.370	6.370
Fabric group 2	6.980	6.980	6.980	6.980
Fabric group 3	7.735	7.735	7.735	7.735
Fabric group 4	9.110	9.110	9.110	9.110
Fabric group 5	10.880	10.880	10.880	10.880
C.O.M. fabric	6.370	6.370	6.370	6.370
Leather group 1	8.210	8.210	8.210	8.210
Leather group 2	10.405	10.405	10.405	10.405
Leather group 3	12.440	12.440	12.440	12.440
Leather group 4	13.685	13.685	13.685	13.685
Leather group 5	15.740	15.740	15.740	15.740
C.O.M. leather	8.210	8.210	8.210	8.210

Fabric consumption: 11,3 m. Leather consumption: 40,5 m²

Note - Complementary cushions are ordered separately (P5522).

Certifications

FSC® certified

EN 1022:2005, EN 16139:2013 (L2)

Recommended upholstery

Fabric group 1	Natural Linen, Erik, Gran Linen, Remix, Capture, Bardal, Re-wool, Linara
Fabric group 2	Hallingdal, Barnum, Loop, Steelcut Trio, Fiord, Ruskin, Savoy
Fabric group 3	Vidar, Divina Melange, Sunniva, Clay
Fabric group 4	Safire, Cotil, Elle, Sisu
Fabric group 5	Gentle
Leather group 1	Omni
Leather group 2	Primo, Trace
Leather group 3	Max
Leather group 4	Nubuck, Organic, Cera, Vegeta

Model 5620

Calmo Ottoman 80x65 cm

Designed by Hugo Passos, 2019



Ottoman with separate seat cushion. Inner frame of wood with nozag springs. Available in fabric or leather. Cushions available in foam core with down wrap or solid foam, either HR or CMHR foam. External cover is non-removable. Cushion cover are removable. Leg trestles in solid wood or steel. Mounted with plastic glides. Felt glides available.

Modeldetails

0,29 m³ Packaging dimensions:
23 kg / L: 68 cm W: 96 cm H: 45 cm
15,5 kg

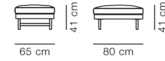

Order configuration

	Oak lacquered	Smoked oak stained, lacquered	Metal black	Matt chrome
Fabric group 1	1.970	1.970	1.970	1.970
Fabric group 2	2.120	2.120	2.120	2.120
Fabric group 3	2.250	2.250	2.250	2.250
Fabric group 4	2.495	2.495	2.495	2.495
Fabric group 5	2.805	2.805	2.805	2.805
C.O.M. fabric	1.970	1.970	1.970	1.970
Leather group 1	2.335	2.335	2.335	2.335
Leather group 2	2.720	2.720	2.720	2.720
Leather group 3	3.080	3.080	3.080	3.080
Leather group 4	3.390	3.390	3.390	3.390
Leather group 5	3.900	3.900	3.900	3.900
C.O.M. leather	2.335	2.335	2.335	2.335

Fabric consumption: 1,74 m. Leather consumption: 4 m²

Certifications

EN 1022:2005, EN 16139:2013 (L2)

Recommended upholstery

Fabric group 1	Natural Linen, Erik, Gran Linen, Remix, Capture, Bardal, Re-wool, Linara
Fabric group 2	Hallingdal, Barnum, Loop, Steelcut Trio, Fiord, Ruskin, Savoy
Fabric group 3	Vidar, Divina Melange, Sunniva, Clay
Fabric group 4	Safire, Cotil, Elle, Sisu
Fabric group 5	Gentle
Leather group 1	Omni
Leather group 2	Primo, Trace
Leather group 3	Max
Leather group 4	Nubuck, Organic, Cera, Vegeta

Model P5522

Calmo Accessories Set of 3 decorative cushions



Designed by Hugo Passos

Decorative cushion for Calmo. Down filling. Removable cover in fabric. Available in fabric or leather.

Modeldetails

0,05 m³ Packaging dimensions:
3,5 kg / 3 kg L: 41 cm W: 41 cm H: 31 cm

Essential Assortment

Pre-configured

Item number	Upholstery	Price
P552219311019	Re-Wool 128	305
P552207722019	Sunniva 242	450
P552207739019	Sunniva 717	450
P552207878019	Sunniva 783	450

Order configuration

Fabric group 1	305
Fabric group 2	385
Fabric group 3	450
Fabric group 4	570
Fabric group 5	720
C.O.M. fabric	305
Leather group 1	490
Leather group 2	680
Leather group 3	850
Leather group 4	935
Leather group 5	1.075
C.O.M. leather	490

Fabric consumption: 1,36 m. Leather consumption: 1,5 m²

Cushion: 40 x 40 cm.

Recommended upholstery

Fabric group 1	Gran Linen, Linara, Bardal, Capture, Remix, Natural Linen, Re-wool, Erik
Fabric group 2	Barnum, Steelcut Trio, Fiord, Hallingdal, Ruskin, Loop, Savoy
Fabric group 3	Vidar, Clay, Sunniva, Divina Melange
Fabric group 4	Sisu, Elle, Safire
Fabric group 5	Gentle

Model 562A

Calmo Elements Configuration A, 333 x 253cm

Modeldetails

- 3,1 m³
- 200 kg /
163 kg



Designed by Hugo Passos, 2022

Sofa with separate seat and back cushions. Inner frame of wood with nozag springs. Available in fabric. Cushions available in foam core with down wrap or solid foam, either HR or CMHR foam. Cushions in fabric are reversible. External cover is non-removable. Cushion covers are removable. Leg trestles in solid wood or steel. Mounted with plastic glides. Felt glides available.



Order configuration

Leg trestles: Oak lacquered, Smoked oak stained lacquered, Metal black or Matt chrome

Fabric group 1	11.145
Fabric group 2	11.965
Fabric group 3	13.520
Fabric group 4	15.925
Fabric group 5	18.980
C.O.M. fabric	11.145

Fabric consumption: 19,22 m

Note - Complementary cushions are ordered separately (P5522).

Certifications

FSC® certified
EN 1022:2005, EN 16139:2013 (L2)

Recommended upholstery

Fabric group 1	Gran Linen, Linara, Bardal, Capture, Remix, Natural Linen, Re-wool, Erik
Fabric group 2	Barnum, Steelcut Trio, Fiord, Hallingdal, Ruskin, Loop, Savoy
Fabric group 3	Vidar, Clay, Sunniva, Divina Melange
Fabric group 4	Sisu, Elle, Safire
Fabric group 5	Gentle

Model 562B

Calmo Elements Configuration B, 333 x 253cm

Modeldetails

- 3,1 m³
- 200 kg /
163 kg



Designed by Hugo Passos, 2022

Sofa with separate seat and back cushions. Inner frame of wood with nozag springs. Available in fabric. Cushions available in foam core with down wrap or solid foam, either HR or CMHR foam. Cushions in fabric are reversible. External cover is non-removable. Cushion covers are removable. Leg trestles in solid wood or steel. Mounted with plastic glides. Felt glides available.



Order configuration

Leg trestles: Oak lacquered, Smoked oak stained lacquered, Metal black or Matt chrome

Fabric group 1	11.145
Fabric group 2	11.965
Fabric group 3	13.520
Fabric group 4	15.925
Fabric group 5	18.980
C.O.M. fabric	11.145

Fabric consumption: 19,22 m

Note - Complementary cushions are ordered separately (P5522).

Certifications

FSC® certified

EN 1022:2005, EN 16139:2013 (L2)

Recommended upholstery

Fabric group 1	Gran Linen, Linara, Bardal, Capture, Remix, Re-wool, Natural Linen, Erik
Fabric group 2	Steelcut Trio, Ruskin, Fiord, Loop, Hallingdal, Barnum, Savoy
Fabric group 3	Vidar, Sunniva, Divina Melange, Clay
Fabric group 4	Sisu, Safire, Elle
Fabric group 5	Gentle

Model 562C

Calmo Elements Configuration C, 333 x 333cm

Modeldetails

3,54 m³

227 kg /
182 kg



Designed by Hugo Passos, 2022

Sofa with separate seat and back cushions. Inner frame of wood with nozag springs. Available in fabric. Cushions available in foam core with down wrap or solid foam, either HR or CMHR foam. Cushions in fabric are reversible. External cover is non-removable. Cushion covers are removable. Leg trestles in solid wood or steel. Mounted with plastic glides. Felt glides available.

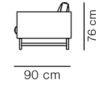

Order configuration

Leg trestles: Oak lacquered, Smoked oak stained lacquered, Metal black or Matt chrome

Fabric group 1	12.255
Fabric group 2	13.070
Fabric group 3	14.790
Fabric group 4	17.440
Fabric group 5	20.805
C.O.M. fabric	12.255

Fabric consumption: 21,9 m

Note - Complementary cushions are ordered separately (P5522).

Certifications

FSC® certified

EN 1022:2005, EN 16139:2013 (L2)

Recommended upholstery

Fabric group 1	Gran Linen, Remix, Capture, Bardal, Re-wool, Linara, Erik, Natural Linen
Fabric group 2	Hallingdal, Steelcut Trio, Ruskin, Barnum, Fiord, Loop, Savoy
Fabric group 3	Divina Melange, Vidar, Sunniva, Clay
Fabric group 4	Safire, Sisu, Elle
Fabric group 5	Gentle

Model 562D

Calmo Elements Configuration D, 253 x 253cm

Modeldetails

2,66 m³

173 kg /
144 kg



Designed by Hugo Passos, 2022

Sofa with separate seat and back cushions. Inner frame of wood with nozag springs. Available in fabric. Cushions available in foam core with down wrap or solid foam, either HR or CMHR foam. Cushions in fabric are reversible. External cover is non-removable. Cushion covers are removable. Leg trestles in solid wood or steel. Mounted with plastic glides. Felt glides available.



Order configuration

Leg trestles: Oak lacquered, Smoked oak stained lacquered, Metal black or Matt chrome

Fabric group 1	10.035
Fabric group 2	10.860
Fabric group 3	12.250
Fabric group 4	14.410
Fabric group 5	17.155
C.O.M. fabric	10.035

Fabric consumption: 16,54 m

Note - Complementary cushions are ordered separately (P5522).

Certifications

FSC® certified

EN 1022:2005, EN 16139:2013 (L2)

Recommended upholstery

Fabric group 1	Gran Linen, Linara, Bardal, Capture, Remix, Natural Linen, Re-wool, Erik
Fabric group 2	Barnum, Steelcut Trio, Loop, Fiord, Hallingdal, Ruskin, Savoy
Fabric group 3	Vidar, Clay, Sunniva, Divina Melange
Fabric group 4	Sisu, Safire, Elle
Fabric group 5	Gentle

Model 562E

Calmo Elements Configuration E, 253 x 174cm

Modeldetails

2,14 m³
149 kg /
130 kg



Designed by Hugo Passos, 2022

Sofa with separate seat and back cushions. Inner frame of wood with nozag springs. Available in fabric. Cushions available in foam core with down wrap or solid foam, either HR or CMHR foam. Cushions in fabric are reversible. External cover is non-removable. Cushion covers are removable. Leg trestles in solid wood or steel. Mounted with plastic glides. Felt glides available.



Order configuration

Leg trestles: Oak lacquered, Smoked oak stained lacquered, Metal black or Matt chrome

Fabric group 1	8.820
Fabric group 2	9.645
Fabric group 3	10.725
Fabric group 4	12.570
Fabric group 5	14.900
C.O.M. fabric	8.820

Fabric consumption: 13,94 m

Note - Complementary cushions are ordered separately (P5522).

Certifications

FSC® certified

EN 1022:2005, EN 16139:2013 (L2)

Recommended upholstery

Fabric group 1	Gran Linen, Linara, Bardal, Capture, Remix, Re-wool, Natural Linen, Erik
Fabric group 2	Barnum, Steelcut Trio, Loop, Fiord, Hallingdal, Ruskin
Fabric group 3	Vidar, Clay, Sunniva, Divina Melange
Fabric group 4	Sisu, Safire, Elle
Fabric group 5	Gentle

Model 562F

Calmo Elements Configuration F, 253 x 174cm

Modeldetails

2,14 m³
149 kg /
130 kg



Designed by Hugo Passos, 2022

Sofa with separate seat and back cushions. Inner frame of wood with nozag springs. Available in fabric. Cushions available in foam core with down wrap or solid foam, either HR or CMHR foam. Cushions in fabric are reversible. External cover is non-removable. Cushion covers are removable. Leg trestles in solid wood or steel. Mounted with plastic glides. Felt glides available.



Order configuration

Leg trestles: Oak lacquered, Smoked oak stained lacquered, Metal black or Matt chrome

Fabric group 1	8.820
Fabric group 2	9.645
Fabric group 3	10.725
Fabric group 4	12.570
Fabric group 5	14.900
C.O.M. fabric	8.820

Fabric consumption: 13,94 m

Note - Complementary cushions are ordered separately (P5522).

Certifications

FSC® certified

EN 1022:2005, EN 16139:2013 (L2)

Recommended upholstery

Fabric group 1	Gran Linen, Linara, Bardal, Capture, Remix, Re-wool, Natural Linen, Erik
Fabric group 2	Ruskin, Fiord, Loop, Savoy, Steelcut Trio, Barnum, Hallingdal
Fabric group 3	Vidar, Sunniva, Divina Melange, Clay
Fabric group 4	Sisu, Safire, Elle
Fabric group 5	Gentle

Model 562G

Calmo Elements Configuration G, 417 x 333cm

Modeldetails

- 5,14 m³
- 329 kg /
268 kg



Designed by Hugo Passos, 2022

Sofa with separate seat and back cushions. Inner frame of wood with nozag springs. Available in fabric. Cushions available in foam core with down wrap or solid foam, either HR or CMHR foam. Cushions in fabric are reversible. External cover is non-removable. Cushion covers are removable. Leg trestles in solid wood or steel. Mounted with plastic glides. Felt glides available.



Order configuration

Leg trestles: Oak lacquered, Smoked oak stained lacquered, Metal black or Matt chrome

Fabric group 1	18.045
Fabric group 2	19.380
Fabric group 3	21.905
Fabric group 4	25.835
Fabric group 5	30.805
C.O.M. fabric	18.045

Fabric consumption: 31,53 m

Note - Complementary cushions are ordered separately (P5522).

Certifications

FSC® certified

EN 1022:2005, EN 16139:2013 (L2)

Recommended upholstery

Fabric group 1	Gran Linen, Remix, Capture, Bardal, Re-wool, Linara, Natural Linen, Erik
Fabric group 2	Steelcut Trio, Hallingdal, Ruskin, Barnum, Fiord, Loop, Savoy
Fabric group 3	Vidar, Divina Melange, Sunniva, Clay
Fabric group 4	Sisu, Safire, Elle
Fabric group 5	Gentle

Model 562H

Calmo Elements Configuration H, 417 x 333cm

Modeldetails

5,14 m³

329 kg /
268 kg



Designed by Hugo Passos, 2022

Sofa with separate seat and back cushions. Inner frame of wood with nozag springs. Available in fabric. Cushions available in foam core with down wrap or solid foam, either HR or CMHR foam. Cushions in fabric are reversible. External cover is non-removable. Cushion covers are removable. Leg trestles in solid wood or steel. Mounted with plastic glides. Felt glides available.

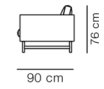

Order configuration

Leg trestles: Oak lacquered, Smoked oak stained lacquered, Metal black or Matt chrome

Fabric group 1	18.045
Fabric group 2	19.380
Fabric group 3	21.905
Fabric group 4	25.835
Fabric group 5	30.805
C.O.M. fabric	18.045

Fabric consumption: 31,53 m

Note - Complementary cushions are ordered separately (P5522).

Certifications

FSC® certified

EN 1022:2005, EN 16139:2013 (L2)

Recommended upholstery

Fabric group 1	Gran Linen, Remix, Capture, Bardal, Re-wool, Linara, Natural Linen, Erik
Fabric group 2	Steelcut Trio, Hallingdal, Ruskin, Barnum, Fiord, Loop, Savoy
Fabric group 3	Vidar, Divina Melange, Sunniva, Clay
Fabric group 4	Sisu, Safire, Elle
Fabric group 5	Gentle

Calmo Elements - Overview

Model 562A, Configuration A

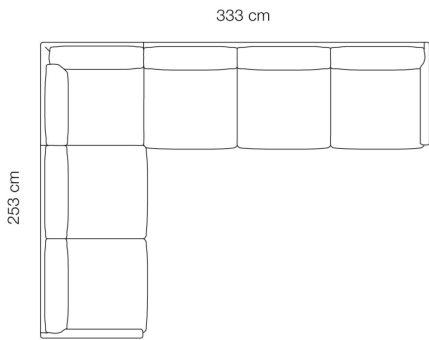

Model 562B, Configuration B

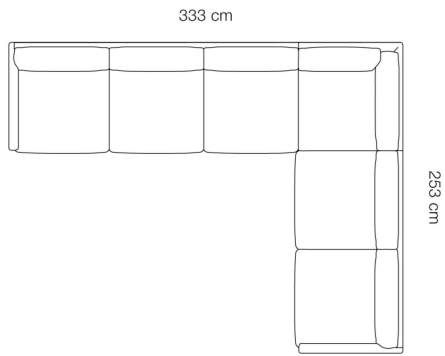

Model 562C, Configuration C

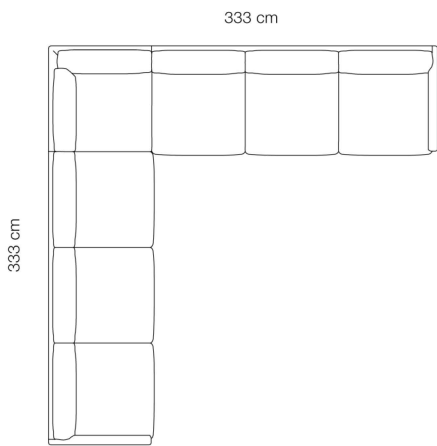

Model 562D, Configuration D

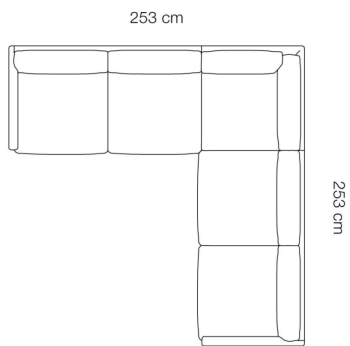

Model 562E, Configuration E

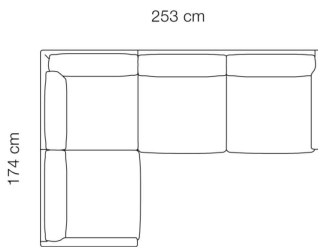

Model 562F, Configuration F

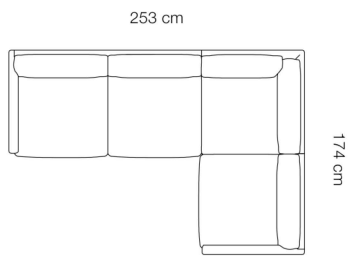

Model 562G, Configuration G

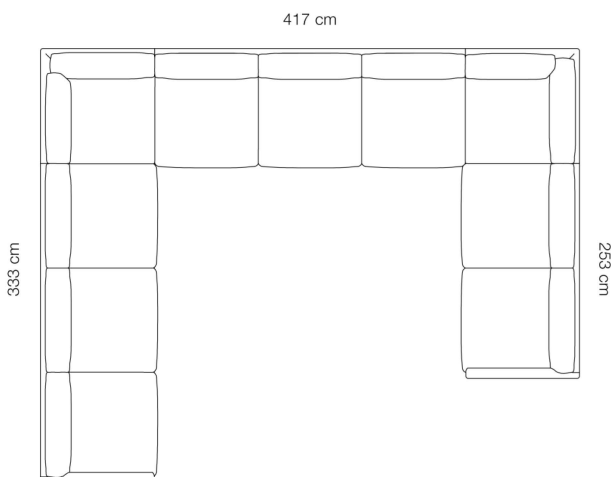

Model 562H, Configuration H

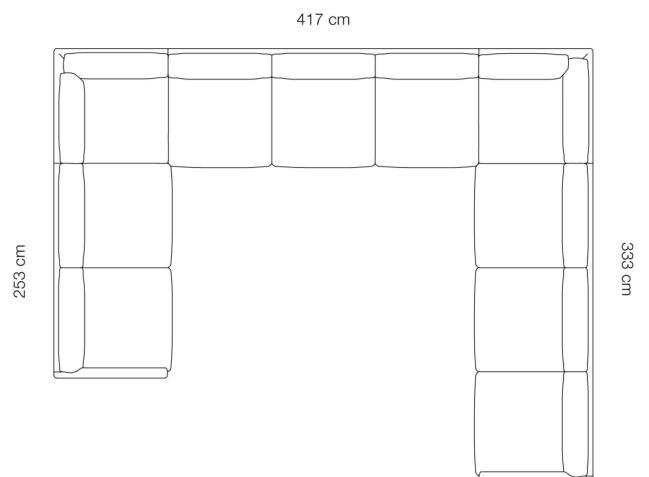

Model 4510

Delphi Sofa 205 cm, 2 seater



Designed by Hannes Wettstein, 2007

Fully upholstered sofa. Inner frame of wood with nozag springs, cold cured foam, either HR or CMHR foam and duvet of cut foam and fibers. Available in fabric or leather with non-removable cover. Aluminum or solid wood base.

Modeldetails

1,3 m³ Packaging dimensions:
100 kg / 90 kg L: 95 cm W: 64 cm H: 210 cm

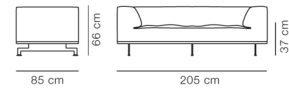

Essential Assortment

Pre-configured

Item number	Upholstery	Legs	Price
45100401009098510100	Steelcut Trio, 213	Brushed aluminium	5.215
45105009809098510100	Leather Max 98, Black	Brushed aluminium	8.890
45105084109098510100	Leather Cera 905, Russet brown	Brushed aluminium	10.500

Essential variants only delivered with HR foam

Order configuration

Plinth: Same as other upholstery or leather (98 black, 95 cognac, 90 natural).

	Brushed aluminium	Oak light oil	Black
Fabric group 1	4.915	4.915	4.915
Fabric group 2	5.215	5.215	5.215
Fabric group 3	5.505	5.505	5.505
Fabric group 4	5.940	5.940	5.940
Fabric group 5	6.980	6.980	6.980
C.O.M. fabric	4.915	4.915	4.915
Leather group 1	6.970	6.970	6.970
Leather group 2	7.705	7.705	7.705
Leather group 3	8.890	8.890	8.890
Leather group 4	10.500	10.500	10.500
Leather group 5	12.990	12.990	12.990
C.O.M. leather	6.970	6.970	6.970

Fabric consumption: 5,8 m. Leather consumption: 16,5 m²

Leather consumption plinth: 2,25 m²

Extra charge for

Leather plinth if upholstery is in fabric:	+830
Extra sitting height (2,5 cm):	+205

Certifications

EN 1022:2005, EN 16139:2013 (L2)

Recommended upholstery

Fabric group 1	Capture, Bardal, Re-wool, Linara, Natural Linen, Erik, Remix
Fabric group 2	Hallingdal, Barnum, Loop, Fiord, Steelcut Trio, Ruskin
Fabric group 3	Divina Melange, Clay, Vidar
Fabric group 4	Elle, Sisu, Safire
Fabric group 5	Gentle
Leather group 1	Omni
Leather group 2	Primo, Trace
Leather group 3	Max
Leather group 4	Nubuck, Vegeta, Cera

Model 4511

Delphi Sofa 240 cm, 3 seater



Designed by Hannes Wettstein, 2007

Fully upholstered sofa. Inner frame of wood with nozag springs, cold cured foam, either HR or CMHR foam and duvet of cut foam and fibers. Available in fabric or leather with non-removable cover. Aluminum or solid wood base.

Modeldetails

1,5 m³ Packaging dimensions:
110 kg / 100 kg L: 245 cm W: 95 cm H: 64 cm

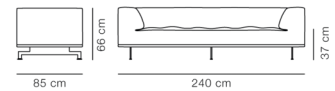

Essential Assortment

Pre-configured

Item number	Upholstery	Legs	Price
45110401009098510100	Steelcut Trio, 213	Brushed aluminium	5.670
45115009809098510100	Leather Max 98, Black	Brushed aluminium	10.205
45115084109098510100	Leather Cera 905, Russet brown	Brushed aluminium	11.855

Essential variants only delivered with HR foam

Order configuration

Plinth: Same as other upholstery or leather (98 black, 95 cognac, 90 natural).

	Brushed aluminium	Oak light oil	Black
Fabric group 1	5.330	5.330	5.330
Fabric group 2	5.670	5.670	5.670
Fabric group 3	5.990	5.990	5.990
Fabric group 4	6.475	6.475	6.475
Fabric group 5	7.640	7.640	7.640
C.O.M. fabric	5.330	5.330	5.330
Leather group 1	7.875	7.875	7.875
Leather group 2	8.770	8.770	8.770
Leather group 3	10.205	10.205	10.205
Leather group 4	11.855	11.855	11.855
Leather group 5	15.540	15.540	15.540
C.O.M. leather	7.875	7.875	7.875

Fabric consumption: 6,5 m. Leather consumption: 20 m²

Leather consumption plinth: 2,25 m²

Extra charge for

Leather plinth if upholstery is in fabric:	+830
Extra sitting height (2,5 cm):	+205

Certifications

EN 1022:2005, EN 16139:2013 (L2)

Recommended upholstery

Fabric group 1	Capture, Bardal, Re-wool, Linara, Natural Linen, Erik, Remix
Fabric group 2	Hallingdal, Barnum, Loop, Fiord, Steelcut Trio, Ruskin
Fabric group 3	Divina Melange, Clay, Vidar
Fabric group 4	Elle, Sisu, Safire
Fabric group 5	Gentle
Leather group 1	Omni
Leather group 2	Primo, Trace
Leather group 3	Max
Leather group 4	Nubuck, Vegeta, Cera

Model 4501

Delphi Elements End module 120x85 cm, Arm L or R



Designed by Hannes Wettstein, 2007

Rectangular end module for Delphi modular sofa system. Fully upholstered in fabric or leather with non-removable cover. Inner frame of wood with nozag springs, cold cured foam, either HR or CMHR foam and duvet of cut foam and fibers. Aluminum or solid wood base. Modules can be independently rearranged. Please specify right- or left-hand corner.

Modeldetails

0,8 m³ Packaging dimensions:
65 kg / 60 kg L: 95 cm W: 64 cm H: 125 cm

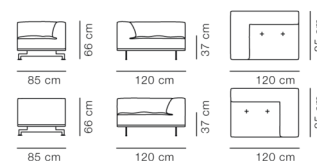

Essential Assortment

Pre-configured

Item number	Upholstery	Legs	Module type	Price
45010401009027510100	Steelcut Trio, 213	Brushed aluminium	Right module	3.050
45010401009028510100	Steelcut Trio, 213	Brushed aluminium	Left module	3.050
45015009809027510100	Leather Max 98, Black	Brushed aluminium	Right module	5.240
45015009809028510100	Leather Max 98, Black	Brushed aluminium	Left module	5.240
45015084109027510100	Leather Cera 905, Russet brown	Brushed aluminium	Right module	6.250
45015084109028510100	Leather Cera 905, Russet brown	Brushed aluminium	Left module	6.250

Essential variants only delivered with HR foam

Order configuration

**Plinth: Same as other upholstery or leather (98 black, 95 cognac, 90 natural).
Right or left hand arm.**

	Brushed aluminium	Oak light oil	Black
Fabric group 1	2.825	2.825	2.825
Fabric group 2	3.050	3.050	3.050
Fabric group 3	3.265	3.265	3.265
Fabric group 4	3.590	3.590	3.590
Fabric group 5	4.365	4.365	4.365
C.O.M. fabric	2.825	2.825	2.825
Leather group 1	4.035	4.035	4.035
Leather group 2	4.500	4.500	4.500
Leather group 3	5.240	5.240	5.240
Leather group 4	6.250	6.250	6.250
Leather group 5	8.000	8.000	8.000
C.O.M. leather	4.035	4.035	4.035

Fabric consumption: 4,2 m. Leather consumption: 10 m²

Leather consumption plinth: 2,25 m²

Extra charge for

Leather plinth if upholstery is in fabric:	+415
Extra sitting height (2,5 cm):	+205

Certifications

EN 1022:2005, EN 16139:2013 (L2)

Recommended upholstery

Fabric group 1	Remix, Capture, Bardal, Re-wool, Linara, Natural Linen, Erik
Fabric group 2	Hallingdal, Steelcut Trio, Fiord, Ruskin, Barnum, Loop
Fabric group 3	Vidar, Clay, Divina Melange
Fabric group 4	Sisu, Safire, Elle
Fabric group 5	Gentle
Leather group 1	Omni
Leather group 2	Primo, Trace
Leather group 3	Max
Leather group 4	Nubuck, Vegeta, Cera

Model 4514

Delphi Elements End module 180x85 cm, Arm L or R



Designed by Hannes Wettstein, 2007

Long rectangular end module for Delphi modular sofa system. Fully upholstered in fabric or leather with non-removable cover. Inner frame of wood with nozag springs, cold cured foam, either HR or CMHR foam and duvet of cut foam and fibers. Aluminum or solid wood base. Modules can be independently rearranged. Please specify right- or left-hand corner.

Modeldetails

1,1 m³ Packaging dimensions:
85 kg / 80 kg L: 95 cm W: 64 cm H: 185 cm

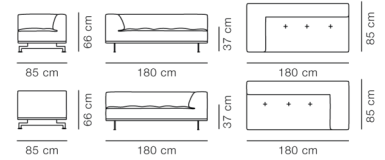

Essential Assortment

Pre-configured

Item number	Upholstery	Legs	Module type	Price
45140401009027510100	Steelcut Trio, 213	Brushed aluminium	Right module	4.040
45140401009028510100	Steelcut Trio, 213	Brushed aluminium	Left module	4.040
45145009809027510100	Leather Max 98, Black	Brushed aluminium	Right module	7.860
45145009809028510100	Leather Max 98, Black	Brushed aluminium	Left module	7.860
45145084109027510100	Leather Cera 905, Russet brown	Brushed aluminium	Right module	8.415
45145084109028510100	Leather Cera 905, Russet brown	Brushed aluminium	Left module	8.415

Essential variants only delivered with HR foam

Order configuration

Plinth: Same as other upholstery or leather (98 black, 95 cognac, 90 natural).
Right or left hand arm.

	Brushed aluminium	Oak light oil	Black
Fabric group 1	3.695	3.695	3.695
Fabric group 2	4.040	4.040	4.040
Fabric group 3	4.205	4.205	4.205
Fabric group 4	4.700	4.700	4.700
Fabric group 5	5.640	5.640	5.640
C.O.M. fabric	3.695	3.695	3.695
Leather group 1	6.020	6.020	6.020
Leather group 2	6.740	6.740	6.740
Leather group 3	7.860	7.860	7.860
Leather group 4	8.415	8.415	8.415
Leather group 5	9.680	9.680	9.680
C.O.M. leather	6.020	6.020	6.020

Fabric consumption: 5,3 m. Leather consumption: 12,5 m²

Leather consumption plinth: 2,25 m²

Extra charge for

Leather plinth if upholstery is in fabric:	+415
Extra sitting height (2,5 cm):	+205

Certifications

EN 1022:2005, EN 16139:2013 (L2)

Recommended upholstery

Fabric group 1	Remix, Capture, Bardal, Re-wool, Linara, Erik, Natural Linen
Fabric group 2	Hallingdal, Barnum, Loop, Steelcut Trio, Fiord, Ruskin
Fabric group 3	Divina Melange, Vidar, Clay
Fabric group 4	Elle, Sisu, Safire
Fabric group 5	Gentle
Leather group 1	Omni
Leather group 2	Primo, Trace
Leather group 3	Max
Leather group 4	Nubuck, Vegeta, Cera

Model 4515

Delphi Elements Chaise Lounge 145x90 cm, Arm L or R



Designed by Hannes Wettstein, 2007

Rectangular chaise lounge module for Delphi modular sofa system. Fully upholstered in fabric or leather with non-removable cover. Inner frame of wood with nozag springs, cold cured foam, either HR or CMHR foam and duvet of cut foam and fibers. Aluminum or solid wood base. Modules can be independently rearranged. Please specify right- or left-hand corner.

Modeldetails

0,95 m³ Packaging dimensions:
60 kg / 52 kg L: 96 cm W: 65 cm H: 151 cm

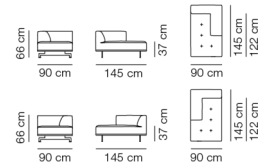

Essential Assortment

Pre-configured

Item number	Upholstery	Legs	Module type	Price
45150401009027510100	Steelcut Trio, 213	Brushed aluminium	Right module	3.375
45150401009028510100	Steelcut Trio, 213	Brushed aluminium	Left module	3.375
45155009809027510100	Leather Max 98, Black	Brushed aluminium	Right module	5.160
45155009809028510100	Leather Max 98, Black	Brushed aluminium	Left module	5.160
45155084109027510100	Leather Cera 905, Russet brown	Brushed aluminium	Right module	5.965
45155084109028510100	Leather Cera 905, Russet brown	Brushed aluminium	Left module	5.965

Essential variants only delivered with HR foam

Order configuration

**Plinth: Same as other upholstery or leather (98 black, 95 cognac, 90 natural).
Right or left hand arm.**

	Brushed aluminium	Oak light oil	Black
Fabric group 1	3.205	3.205	3.205
Fabric group 2	3.375	3.375	3.375
Fabric group 3	3.540	3.540	3.540
Fabric group 4	3.790	3.790	3.790
Fabric group 5	4.380	4.380	4.380
C.O.M. fabric	3.205	3.205	3.205
Leather group 1	4.195	4.195	4.195
Leather group 2	4.565	4.565	4.565
Leather group 3	5.160	5.160	5.160
Leather group 4	5.965	5.965	5.965
Leather group 5	7.370	7.370	7.370
C.O.M. leather	4.195	4.195	4.195

Fabric consumption: 4 m. Leather consumption: 10 m²

Leather consumption plinth: 2,25 m²

Extra charge for

Leather plinth if upholstery is in fabric:	+415
Extra sitting height (2,5 cm):	+205

Certifications

EN 1022:2005, EN 16139:2013 (L2)

Recommended upholstery

Fabric group 1	Remix, Capture, Bardal, Re-wool, Linara, Erik, Natural Linen
Fabric group 2	Hallingdal, Barnum, Loop, Steelcut Trio, Fiord, Ruskin
Fabric group 3	Divina Melange, Vidar, Clay
Fabric group 4	Elle, Sisu, Safire
Fabric group 5	Gentle
Leather group 1	Omni
Leather group 2	Primo, Trace
Leather group 3	Max
Leather group 4	Nubuck, Vegeta, Cera

Model 4517

Delphi Elements

Open-end 145x85 cm, Open in L or R



Designed by Hannes Wettstein, 2007

Rectangular open-end module for Delphi modular sofa system. Fully upholstered in fabric or leather with non-removable cover. Inner frame of wood with nozag springs, cold cured foam, either HR or CMHR foam and duvet of cut foam and fibers. Aluminum or solid wood base. Modules can be independently rearranged. Please specify right- or left-hand corner.

Modeldetails

0,95 m³ Packaging dimensions:
53 kg / 45 kg L: 96 cm W: 65 cm H: 151 cm

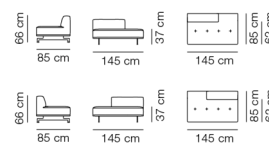

Essential Assortment

Pre-configured

Item number	Upholstery	Legs	Module type	Price
45170401009034510100	Steelcut Trio, 213	Brushed aluminium	Open right side	3.040
45170401009035510100	Steelcut Trio, 213	Brushed aluminium	Open left side	3.040
45175009809034510100	Leather Max 98, Black	Brushed aluminium	Open right side	4.895
45175009809035510100	Leather Max 98, Black	Brushed aluminium	Open left side	4.895
45175084109034510100	Leather Cera 905, Russet brown	Brushed aluminium	Open right side	5.700
45175084109035510100	Leather Cera 905, Russet brown	Brushed aluminium	Open left side	5.700

Essential variants only delivered with HR foam

Order configuration

Plinth: Same as other upholstery or leather (98 black, 95 cognac, 90 natural).
Open in right or left side.

	Brushed aluminium	Oak light oil	Black
Fabric group 1	2.890	2.890	2.890
Fabric group 2	3.040	3.040	3.040
Fabric group 3	3.185	3.185	3.185
Fabric group 4	3.400	3.400	3.400
Fabric group 5	3.920	3.920	3.920
C.O.M. fabric	2.890	2.890	2.890
Leather group 1	3.930	3.930	3.930
Leather group 2	4.300	4.300	4.300
Leather group 3	4.895	4.895	4.895
Leather group 4	5.700	5.700	5.700
Leather group 5	7.105	7.105	7.105
C.O.M. leather	3.930	3.930	3.930

Fabric consumption: 4 m. Leather consumption: 10 m²

Leather consumption plinth: 2,25 m²

Extra charge for

Leather plinth if upholstery is in fabric:	+415
Extra sitting height (2,5 cm):	+205

Certifications

EN 1022:2005, EN 16139:2013 (L2)

Recommended upholstery

Fabric group 1	Remix, Natural Linen, Erik, Capture, Bardal, Re-wool, Linara
Fabric group 2	Steelcut Trio, Hallingdal, Barnum, Loop, Fiord, Ruskin
Fabric group 3	Vidar, Divina Melange, Clay
Fabric group 4	Elle, Sisu, Safire
Fabric group 5	Gentle
Leather group 1	Omni
Leather group 2	Primo, Trace
Leather group 3	Max
Leather group 4	Nubuck, Vegeta, Cera

Model 4502

Delphi Elements Seat module 120x85 cm



Designed by Hannes Wettstein, 2007

Wide seat module for Delphi modular sofa system. Fully upholstered in fabric or leather with non-removable cover. Inner frame of wood with nozag springs, cold cured foam, either HR or CMHR foam and duvet of cut foam and fibers. Aluminum or solid wood base. Modules can be independently rearranged.

Modeldetails

0,8 m³ Packaging dimensions:
59 kg / 54 kg L: 95 cm W: 64 cm H: 125 cm

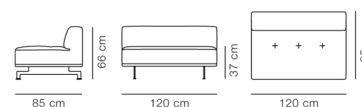

Essential Assortment

Pre-configured

Item number	Upholstery	Legs	Price
45020401009098510100	Steelcut Trio, 213	Brushed aluminium	2.705
45025009809098510100	Leather Max 98, Black	Brushed aluminium	5.370
45025084109098510100	Leather Cera 905, Russet brown	Brushed aluminium	5.750

Essential variants only delivered with HR foam

Order configuration

Plinth: Same as other upholstery or leather (98 black, 95 cognac, 90 natural).

	Brushed aluminium	Oak light oil	Black
Fabric group 1	2.475	2.475	2.475
Fabric group 2	2.705	2.705	2.705
Fabric group 3	2.815	2.815	2.815
Fabric group 4	3.150	3.150	3.150
Fabric group 5	3.785	3.785	3.785
C.O.M. fabric	2.475	2.475	2.475
Leather group 1	4.095	4.095	4.095
Leather group 2	4.595	4.595	4.595
Leather group 3	5.370	5.370	5.370
Leather group 4	5.750	5.750	5.750
Leather group 5	6.615	6.615	6.615
C.O.M. leather	4.095	4.095	4.095

Fabric consumption: 3,6 m. Leather consumption: 10 m²

Leather consumption plinth: 2,25 m²

Extra charge for

Leather plinth if upholstery is in fabric:	+415
Extra sitting height (2,5 cm):	+205

Certifications

EN 1022:2005, EN 16139:2013 (L2)

Recommended upholstery

Fabric group 1	Remix, Capture, Bardal, Natural Linen, Erik, Re-wool, Linara
Fabric group 2	Hallingdal, Barnum, Fiord, Loop, Steelcut Trio, Ruskin
Fabric group 3	Divina Melange, Vidar, Clay
Fabric group 4	Safire, Elle, Sisu
Fabric group 5	Gentle
Leather group 1	Omni
Leather group 2	Primo, Trace
Leather group 3	Max
Leather group 4	Nubuck, Vegeta, Cera

Model 4506

Delphi Elements Seat module 85x85 cm



Designed by Hannes Wettstein, 2007

Short seat module for Delphi modular sofa system. Fully upholstered in fabric or leather with non-removable cover. Inner frame of wood with nozag springs, cold cured foam, either HR or CMHR foam and duvet of cut foam and fibers. Aluminum or solid wood base. Modules can be independently rearranged.

Modeldetails

0,6 m³ Packaging dimensions:
45 kg / 40 kg L: 95 cm W: 64 cm H: 100 cm

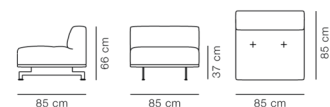

Essential Assortment

Pre-configured

Item number	Upholstery	Legs	Price
45060401009098510100	Steelcut Trio, 213	Brushed aluminium	2.360
45065009809098510100	Leather Max 98, Black	Brushed aluminium	3.945
45065084109098510100	Leather Cera 905, Russet brown	Brushed aluminium	4.655

Essential variants only delivered with HR foam

Order configuration

Plinth: Same as other upholstery or leather (98 black, 95 cognac, 90 natural).

	Brushed aluminium	Oak light oil	Black
Fabric group 1	2.215	2.215	2.215
Fabric group 2	2.360	2.360	2.360
Fabric group 3	2.500	2.500	2.500
Fabric group 4	2.710	2.710	2.710
Fabric group 5	3.215	3.215	3.215
C.O.M. fabric	2.215	2.215	2.215
Leather group 1	3.100	3.100	3.100
Leather group 2	3.425	3.425	3.425
Leather group 3	3.945	3.945	3.945
Leather group 4	4.655	4.655	4.655
Leather group 5	5.880	5.880	5.880
C.O.M. leather	3.100	3.100	3.100

Fabric consumption: 2,9 m. Leather consumption: 7,5 m²

Leather consumption plinth: 2,25 m²

Extra charge for

Leather plinth if upholstery is in fabric:	+415
Extra sitting height (2,5 cm):	+205

Certifications

EN 1022:2005, EN 16139:2013 (L2)

Recommended upholstery

Fabric group 1	Remix, Capture, Bardal, Re-wool, Linara, Natural Linen, Erik
Fabric group 2	Steelcut Trio, Fiord, Ruskin, Hallingdal, Barnum, Loop
Fabric group 3	Vidar, Clay, Divina Melange
Fabric group 4	Sisu, Safire, Elle
Fabric group 5	Gentle
Leather group 1	Omni
Leather group 2	Primo, Trace
Leather group 3	Max
Leather group 4	Nubuck, Vegeta, Cera

Model 4503

Delphi Elements Side chaise module 85x120 cm



Designed by Hannes Wettstein, 2007

Side module with extended depth for L-configuration of Delphi modular sofa. Fully upholstered in fabric or leather with non-removable cover. Inner frame of wood with nozag springs, cold cured foam, either HR or CMHR foam and duvet of cut foam and fibers. Aluminum or solid wood base. The backrest of the module is designed to be used in connection with main sofa armrest. Modules can be independently rearranged.

Modeldetails

0,8 m³ Packaging dimensions:
59 kg / 54 kg L: 95 cm W: 64 cm H: 125 cm

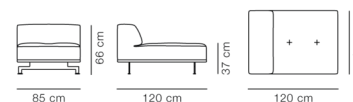

Essential Assortment

Pre-configured

Item number	Upholstery	Legs	Price
45030401009098510100	Steelcut Trio, 213	Brushed aluminium	2.665
45035009809098510100	Leather Max 98, Black	Brushed aluminium	5.110
45035084109098510100	Leather Cera 905, Russet brown	Brushed aluminium	5.460

Essential variants only delivered with HR foam

Order configuration

Plinth: Same as other upholstery or leather (98 black, 95 cognac, 90 natural).

	Brushed aluminium	Oak light oil	Black
Fabric group 1	2.445	2.445	2.445
Fabric group 2	2.665	2.665	2.665
Fabric group 3	2.765	2.765	2.765
Fabric group 4	3.080	3.080	3.080
Fabric group 5	3.695	3.695	3.695
C.O.M. fabric	2.445	2.445	2.445
Leather group 1	3.935	3.935	3.935
Leather group 2	4.395	4.395	4.395
Leather group 3	5.110	5.110	5.110
Leather group 4	5.460	5.460	5.460
Leather group 5	6.280	6.280	6.280
C.O.M. leather	3.935	3.935	3.935

Fabric consumption: 3,3 m. Leather consumption: 10 m²

Leather consumption plinth: 2,25 m²

Extra charge for

Leather plinth if upholstery is in fabric:	+415
Extra sitting height (2,5 cm):	+205

Certifications

EN 1022:2005, EN 16139:2013 (L2)

Recommended upholstery

Fabric group 1	Natural Linen, Erik, Remix, Capture, Bardal, Re-wool, Linara
Fabric group 2	Hallingdal, Barnum, Loop, Steelcut Trio, Fiord, Ruskin
Fabric group 3	Divina Melange, Vidar, Clay
Fabric group 4	Safire, Elle, Sisu
Fabric group 5	Gentle
Leather group 1	Omni
Leather group 2	Primo, Trace
Leather group 3	Max
Leather group 4	Nubuck, Vegeta, Cera

Model 4513

Delphi Elements Corner module 85x85 cm



Designed by Hannes Wettstein, 2007

Square corner module for Delphi modular sofa system. Fully upholstered in fabric or leather with non-removable cover. Inner frame of wood with nozag springs, cold cured foam, either HR or CMHR foam and duvet of cut foam and fibers. Aluminum or solid wood base. Modules can be independently rearranged.

Modeldetails

0,6 m³ Packaging dimensions:
50 kg / 45 kg L: 95 cm W: 64 cm H: 100 cm

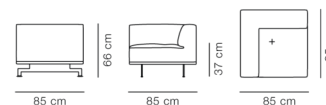

Essential Assortment

Pre-configured

Item number	Upholstery	Legs	Price
45130401009098510100	Steelcut Trio, 213	Brushed aluminium	2.965
45135009809098510100	Leather Max 98, Black	Brushed aluminium	5.550
45135084109098510100	Leather Cera 905, Russet brown	Brushed aluminium	5.925

Essential variants only delivered with HR foam

Order configuration

Plinth: Same as other upholstery or leather (98 black, 95 cognac, 90 natural).

	Brushed aluminium	Oak light oil	Black
Fabric group 1	2.735	2.735	2.735
Fabric group 2	2.965	2.965	2.965
Fabric group 3	3.075	3.075	3.075
Fabric group 4	3.405	3.405	3.405
Fabric group 5	4.085	4.085	4.085
C.O.M. fabric	2.735	2.735	2.735
Leather group 1	4.305	4.305	4.305
Leather group 2	4.795	4.795	4.795
Leather group 3	5.550	5.550	5.550
Leather group 4	5.925	5.925	5.925
Leather group 5	6.815	6.815	6.815
C.O.M. leather	4.305	4.305	4.305

Fabric consumption: 3,5 m. Leather consumption: 7,5 m²

Leather consumption plinth: 2,25 m²

Extra charge for

Leather plinth if upholstery is in fabric:	+415
Extra sitting height (2,5 cm):	+205

Certifications

EN 1022:2005, EN 16139:2013 (L2)

Recommended upholstery

Fabric group 1	Remix, Capture, Bardal, Re-wool, Linara, Natural Linen, Erik
Fabric group 2	Loop, Steelcut Trio, Hallingdal, Barnum, Fiord, Ruskin
Fabric group 3	Vidar, Divina Melange, Clay
Fabric group 4	Elle, Sisu, Safire
Fabric group 5	Gentle
Leather group 1	Omni
Leather group 2	Primo, Trace
Leather group 3	Max
Leather group 4	Nubuck, Vegeta, Cera

Model 4504

Delphi Elements Ottoman 120x85 cm



Designed by Hannes Wettstein, 2007

Ottoman with inner frame of wood, cold cured foam and foam duvet. Fully upholstered in fabric or leather with non-removable cover. Inner frame of wood with nozag springs, cold cured foam, either HR or CMHR foam and duvet of cut foam and fibers. Aluminum or solid wood base. Can be used as part of modular configuration. Modules can be independently rearranged.

Modeldetails

0,6 m³ Packaging dimensions:
52 kg / 47 kg L: 88 cm W: 52 cm H: 125 cm

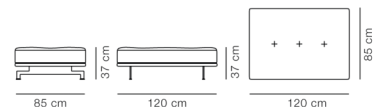

Essential Assortment

Pre-configured

Item number	Upholstery	Legs	Price
45040401009098510100	Steelcut Trio, 213	Brushed aluminium	2.135
45045009809098510100	Leather Max 98, Black	Brushed aluminium	3.395
45045084109098510100	Leather Cera 905, Russet brown	Brushed aluminium	4.115

Essential variants only delivered with HR foam

Order configuration

Plinth: Same as other upholstery or leather (98 black, 95 cognac, 90 natural).

	Brushed aluminium	Oak light oil	Black
Fabric group 1	2.015	2.015	2.015
Fabric group 2	2.135	2.135	2.135
Fabric group 3	2.255	2.255	2.255
Fabric group 4	2.425	2.425	2.425
Fabric group 5	2.845	2.845	2.845
C.O.M. fabric	2.015	2.015	2.015
Leather group 1	2.720	2.720	2.720
Leather group 2	2.980	2.980	2.980
Leather group 3	3.395	3.395	3.395
Leather group 4	4.115	4.115	4.115
Leather group 5	5.250	5.250	5.250
C.O.M. leather	2.720	2.720	2.720

Fabric consumption: 2,6 m. Leather consumption: 6,5 m²

Leather consumption plinth: 2,25 m²

Extra charge for

Leather plinth if upholstery is in fabric:	+415
Extra sitting height (2,5 cm):	+205

Certifications

EN 1022:2005, EN 16139:2013 (L2)

Recommended upholstery

Fabric group 1	Remix, Natural Linen, Erik, Capture, Bardal, Re-wool, Linara
Fabric group 2	Steelcut Trio, Hallingdal, Barnum, Loop, Fiord, Ruskin
Fabric group 3	Vidar, Divina Melange, Clay
Fabric group 4	Elle, Sisu, Safire
Fabric group 5	Gentle
Leather group 1	Omni
Leather group 2	Primo, Trace
Leather group 3	Max
Leather group 4	Nubuck, Vegeta, Cera

Model 4505

Delphi Elements Ottoman 85x85 cm



Designed by Hannes Wettstein, 2007

Ottoman with inner frame of wood, cold cured foam and foam duvet. Fully upholstered in fabric or leather with non-removable cover. Inner frame of wood with nozag springs, cold cured foam, either HR or CMHR foam and duvet of cut foam and fibers. Aluminum or solid wood base. Can be used as part of modular configuration. Modules can be independently rearranged.

Modeldetails

0,4 m³ Packaging dimensions:
30 kg / 25 kg L: 85 cm W: 52 cm H: 95 cm

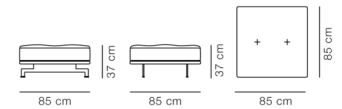

Essential Assortment

Pre-configured

Item number	Upholstery	Legs	Price
45050401009098510100	Steelcut Trio, 213	Brushed aluminium	2.035
45055009809098510100	Leather Max 98, Black	Brushed aluminium	3.360
45055084109098510100	Leather Cera 905, Russet brown	Brushed aluminium	3.885

Essential variants only delivered with HR foam

Order configuration

Plinth: Same as other upholstery or leather (98 black, 95 cognac, 90 natural).

	Brushed aluminium	Oak light oil	Black
Fabric group 1	1.895	1.895	1.895
Fabric group 2	2.035	2.035	2.035
Fabric group 3	2.105	2.105	2.105
Fabric group 4	2.310	2.310	2.310
Fabric group 5	2.770	2.770	2.770
C.O.M. fabric	1.895	1.895	1.895
Leather group 1	2.650	2.650	2.650
Leather group 2	2.955	2.955	2.955
Leather group 3	3.360	3.360	3.360
Leather group 4	3.885	3.885	3.885
Leather group 5	4.470	4.470	4.470
C.O.M. leather	2.650	2.650	2.650

Fabric consumption: 1,9 m. Leather consumption: 6 m²

Leather consumption plinth: 2,25 m²

Extra charge for

Leather plinth if upholstery is in fabric:	+415
Extra sitting height (2,5 cm):	+205

Certifications

EN 1022:2005, EN 16139:2013 (L2)

Recommended upholstery

Fabric group 1	Gran Linen, Linara, Bardal, Capture, Remix, Re-wool, Erik, Natural Linen
Fabric group 2	Barnum, Steelcut Trio, Fiord, Hallingdal, Ruskin, Loop
Fabric group 3	Vidar, Clay, Divina Melange
Fabric group 4	Sisu, Elle, Safire
Fabric group 5	Gentle
Leather group 3	Max
Leather group 4	Cera

Model P4500

Delphi Accessories Decorative cushion

Modeldetails



Designed by Hannes Wettstein, 2007

Decorative cushion for Delphi. Down and foam granulate mix filling. Removable cover in leather or fabric.

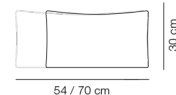

Essential Assortment

Pre-configured

Item number	Upholstery	Cushion	Price
P450004010002100	Steelcut Trio, 213	54 x 30 cm	180
P450004010002200	Steelcut Trio, 213	70 x 30 cm	210
P450050098002100	Leather Max 98, Black	54 x 30 cm	300
P450050098002200	Leather Max 98, Black	70 x 30 cm	310
P450050841002100	Leather Cera 905, Russet brown	54 x 30 cm	365
P450050841002200	Leather Cera 905, Russet brown	70 x 30 cm	370

Essential variants only delivered with HR foam

Order configuration

	Short cushion 54 x 30 cm	Long cushion 70 x 30 cm
Fabric group 1	155	185
Fabric group 2	180	210
Fabric group 3	200	240
Fabric group 4	235	285
Fabric group 5	310	380
C.O.M. fabric	155	185
Leather group 1	230	240
Leather group 2	260	270
Leather group 3	300	310
Leather group 4	365	370
Leather group 5	475	480
C.O.M. leather	155	185

Fabric and leather consumption:

Short cushion, 0,65 m / 1 m²

Long cushion, 0,85 m / 1,25 m²

Recommended upholstery

Fabric group 1	Remix, Capture, Bardal, Re-wool, Linara, Natural Linen, Erik
Fabric group 2	Ruskin, Fiord, Loop, Steelcut Trio, Barnum, Hallingdal
Fabric group 3	Vidar, Divina Melange, Clay
Fabric group 4	Sisu, Safire, Elle
Fabric group 5	Gentle
Leather group 1	Omni
Leather group 2	Primo, Trace
Leather group 3	Max
Leather group 4	Nubuck, Vegeta, Cera

Model 450A

Delphi Elements Configuration A, 325 x 170cm

Modeldetails

70 m³ Packaging dimensions:
227 kg / L: 125/125/100/125 cm W:
207 kg 88/95/95/95 cm H: 52/64/64/64 cm



Designed by Hannes Wettstein, 2007

Delphi modular sofa system. Fully upholstered in fabric or leather with non-removable cover. Inner frame of wood with nozag springs, cold cured foam, either HR or CMHR foam and duvet of cut foam and fibers. Aluminum or solid wood base. Modules can be independently rearranged.

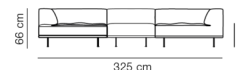

Essential Assortment

Pre-configured

Item number	Upholstery	Legs	Price
450A0401009000510100	Steelcut Trio, 213	Brushed aluminium	10.595
450A5009809000510100	Leather Max 98, Black	Brushed aluminium	17.820
450A5084109000510100	Leather Cera 905, Russet brown	Brushed aluminium	21.270

Essential variants only delivered with HR foam

Order configuration

Base: Brushed aluminium, black or Oak light oil.

Plinth: Same as other upholstery or leather (98 black, 95 cognac, 90 natural).

Fabric group 1	9.880
Fabric group 2	10.595
Fabric group 3	11.285
Fabric group 4	12.315
Fabric group 5	14.790
C.O.M. fabric	9.880
Leather group 1	13.890
Leather group 2	15.405
Leather group 3	17.820
Leather group 4	21.270
Leather group 5	27.130
C.O.M. leather	13.890

Fabric consumption: 13,9 m. Leather consumption: 34 m²

Extra charge for

Leather plinth if upholstery is in fabric: +1.665
Extra sitting height (2,5 cm): +820

Recommended upholstery

Fabric group 1	Linara, Bardal, Re-wool, Remix, Capture, Natural Linen, Erik
Fabric group 2	Hallingdal, Barnum, Fiord, Steelcut Trio, Ruskin, Loop
Fabric group 3	Vidar, Divina Melange, Clay
Fabric group 4	Sisu, Elle, Safire
Fabric group 5	Gentle
Leather group 1	Omni
Leather group 2	Primo, Trace
Leather group 3	Max
Leather group 4	Nubuck, Vegeta, Cera

Model 450B

Delphi Elements Configuration B, 265 x 205cm

Modeldetails

📦 835 m³	Packaging dimensions:
📦 200 kg / 185 kg	L: 125/101/185 cm W: 95/95/95 cm H: 64/64/64 cm



Designed by Hannes Wettstein, 2007

Delphi modular sofa system. Fully upholstered in fabric or leather with non-removable cover. Inner frame of wood with nozag springs, cold cured foam, either HR or CMHR foam and duvet of cut foam and fibers. Aluminum or solid wood base. Modules can be independently rearranged.

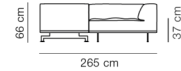

Essential Assortment

Pre-configured

Item number	Upholstery	Legs	Price
450B0401009000510100	Steelcut Trio, 213	Brushed aluminium	10.055
450B5009809000510100	Leather Max 98, Black	Brushed aluminium	18.650
450B5084109000510100	Leather Cera 905, Russet brown	Brushed aluminium	20.590

Essential variants only delivered with HR foam

Order configuration

Base: Brushed aluminium, black or Oak light oil.

Plinth: Same as other upholstery or leather (98 black, 95 cognac, 90 natural).

Fabric group 1	9.255
Fabric group 2	10.055
Fabric group 3	10.545
Fabric group 4	11.695
Fabric group 5	14.090
C.O.M. fabric	9.255
Leather group 1	14.360
Leather group 2	16.035
Leather group 3	18.650
Leather group 4	20.590
Leather group 5	24.495
C.O.M. leather	14.360

Fabric consumption: 13 m. Leather consumption: 30 m²

Extra charge for

Leather plinth if upholstery is in fabric:	+1.250
Extra sitting height (2,5 cm):	+615

Recommended upholstery

Fabric group 1	Remix, Re-wool, Capture, Bardal, Linara, Natural Linen, Erik
Fabric group 2	Steelcut Trio, Fiord, Hallingdal, Ruskin, Barnum, Loop
Fabric group 3	Divina Melange, Vidar, Clay
Fabric group 4	Elle, Safire, Sisu
Fabric group 5	Gentle
Leather group 1	Omni
Leather group 2	Primo, Trace
Leather group 3	Max
Leather group 4	Nubuck, Vegeta, Cera

Model 450D

Delphi Elements Configuration D, 265 x 205cm



Designed by Hannes Wettstein, 2007

Delphi modular sofa system. Fully upholstered in fabric or leather with non-removable cover. Inner frame of wood with nozag springs, cold cured foam, either HR or CMHR foam and duvet of cut foam and fibers. Aluminum or solid wood base. Modules can be independently rearranged.

Modeldetails

835 m³ Packaging dimensions:
307 kg / L: 185/101/125 cm W: 95/95/95 cm
282 kg H: 64/64/64 cm

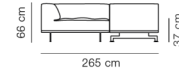

Essential Assortment

Pre-configured

Item number	Upholstery	Legs	Price
450D0401009000510100	Steelcut Trio, 213	Brushed aluminium	10.055
450D5009809000510100	Leather Max 98, Black	Brushed aluminium	18.650
450D5084109000510100	Leather Cera 905, Russet brown	Brushed aluminium	20.590

Essential variants only delivered with HR foam

Order configuration

Base: Brushed aluminium, black or Oak light oil.

Plinth: Same as other upholstery or leather (98 black, 95 cognac, 90 natural).

Fabric group 1	9.255
Fabric group 2	10.055
Fabric group 3	10.545
Fabric group 4	11.695
Fabric group 5	14.090
C.O.M. fabric	9.255
Leather group 1	14.360
Leather group 2	16.035
Leather group 3	18.650
Leather group 4	20.590
Leather group 5	24.495
C.O.M. leather	14.360

Fabric consumption: 18,6 m. Leather consumption: 50 m²

Extra charge for

Leather plinth if upholstery is in fabric:	+1.250
Extra sitting height (2,5 cm):	+615

Recommended upholstery

Fabric group 1	Linara, Bardal, Capture, Re-wool, Remix, Natural Linen, Erik
Fabric group 2	Steelcut Trio, Loop, Fiord, Barnum, Hallingdal, Ruskin
Fabric group 3	Vidar, Divina Melange, Clay
Fabric group 4	Sisu, Safire, Elle
Fabric group 5	Gentle
Leather group 1	Omni
Leather group 2	Primo, Trace
Leather group 3	Max
Leather group 4	Nubuck, Vegeta, Cera

Model 450C

Delphi Elements Configuration C, 360 x 255cm

Modeldetails

📦 8 m³	Packaging dimensions:
📦 200 kg / 185 kg	L: 125/125/125/125 cm W: 95/95/95/95 cm H: 64/64/64/6



Designed by Hannes Wettstein, 2007

Delphi modular sofa system. Fully upholstered in fabric or leather with non-removable cover. Inner frame of wood with nozag springs, cold cured foam, either HR or CMHR foam and duvet of cut foam and fibers. Aluminum or solid wood base. Modules can be independently rearranged.

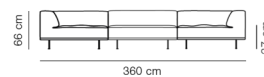

Essential Assortment

Pre-configured

Item number	Upholstery	Legs	Price
450C0401009000510100	Steelcut Trio, 213	Brushed aluminium	14.135
450C5009809000510100	Leather Max 98, Black	Brushed aluminium	26.070
450C5084109000510100	Leather Cera 905, Russet brown	Brushed aluminium	29.170

Essential variants only delivered with HR foam

Order configuration

Base: Brushed aluminium, black or Oak light oil.

Plinth: Same as other upholstery or leather (98 black, 95 cognac, 90 natural).

Fabric group 1	13.015
Fabric group 2	14.135
Fabric group 3	14.875
Fabric group 4	16.490
Fabric group 5	19.905
C.O.M. fabric	13.015
Leather group 1	20.035
Leather group 2	22.385
Leather group 3	26.070
Leather group 4	29.170
Leather group 5	35.175
C.O.M. leather	20.035

Fabric consumption: 13 m. Leather consumption: 30 m²

Extra charge for

Leather plinth if upholstery is in fabric:	+2.085
Extra sitting height (2,5 cm):	+1.025

Recommended upholstery

Fabric group 1	Remix, Capture, Bardal, Re-wool, Linara, Erik, Natural Linen
Fabric group 2	Hallingdal, Barnum, Loop, Steelcut Trio, Fiord, Ruskin
Fabric group 3	Divina Melange, Vidar, Clay
Fabric group 4	Elle, Sisu, Safire
Fabric group 5	Gentle
Leather group 1	Omni
Leather group 2	Primo, Trace
Leather group 3	Max
Leather group 4	Nubuck, Vegeta, Cera

Model 450E

Delphi Elements Configuration E, 235 x 145cm



Designed by Hannes Wettstein, 2007

Delphi modular sofa system. Fully upholstered in fabric or leather with non-removable cover. Inner frame of wood with nozag springs, cold cured foam, either HR or CMHR foam and duvet of cut foam and fibers. Aluminum or solid wood base. Modules can be independently rearranged.

Modeldetails

9,5 m³ Packaging dimensions:
113 kg / L: 96/96 cm W: 65/65 cm H:
97 kg 151/151 cm

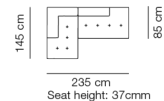

Order configuration

Base: Brushed aluminium, black or Oak light oil.

Plinth: Same as other upholstery or leather (98 black, 95 cognac, 90 natural).

Fabric group 1	6.095
Fabric group 2	6.415
Fabric group 3	6.725
Fabric group 4	7.190
Fabric group 5	8.300
C.O.M. fabric	6.095
Leather group 1	8.125
Leather group 2	8.865
Leather group 3	10.055
Leather group 4	11.665
Leather group 5	14.475
C.O.M. leather	8.125

Fabric consumption: 8 m. Leather consumption: 20 m²

Extra charge for

Leather plinth if upholstery is in fabric:	+830
Extra sitting height (2,5 cm):	+410

Recommended upholstery

Fabric group 1	Remix, Capture, Bardal, Re-wool, Linara, Erik, Natural Linen
Fabric group 2	Hallingdal, Barnum, Loop, Steelcut Trio, Fiord, Ruskin
Fabric group 3	Divina Melange, Vidar, Clay
Fabric group 4	Elle, Sisu, Safire
Fabric group 5	Gentle
Leather group 1	Omni
Leather group 2	Primo, Trace
Leather group 3	Max
Leather group 4	Nubuck, Vegeta, Cera

Model 450F

Delphi Elements Configuration F, 235 x 145cm



Designed by Hannes Wettstein, 2007

Delphi modular sofa system. Fully upholstered in fabric or leather with non-removable cover. Inner frame of wood with nozag springs, cold cured foam, either HR or CMHR foam and duvet of cut foam and fibers. Aluminum or solid wood base. Modules can be independently rearranged.

Modeldetails

9,5 m³ Packaging dimensions:
113 kg / 97 kg L: 96/96 cm W: 65/65 cm H:
151/151 cm

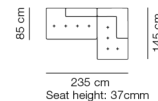

Order configuration

Base: Brushed aluminium, black or Oak light oil.

Plinth: Same as other upholstery or leather (98 black, 95 cognac, 90 natural).

Fabric group 1	6.095
Fabric group 2	6.415
Fabric group 3	6.725
Fabric group 4	7.190
Fabric group 5	8.300
C.O.M. fabric	6.095
Leather group 1	8.125
Leather group 2	8.865
Leather group 3	10.055
Leather group 4	11.665
Leather group 5	14.475
C.O.M. leather	8.125

Fabric consumption: 8 m. Leather consumption: 20 m²

Extra charge for

Leather plinth if upholstery is in fabric:	+830
Extra sitting height (2,5 cm):	+410

Recommended upholstery

Fabric group 1	Remix, Capture, Bardal, Re-wool, Linara, Erik, Natural Linen
Fabric group 2	Hallingdal, Barnum, Loop, Steelcut Trio, Fiord, Ruskin
Fabric group 3	Divina Melange, Vidar, Clay
Fabric group 4	Elle, Sisu, Safire
Fabric group 5	Gentle
Leather group 1	Omni
Leather group 2	Primo, Trace
Leather group 3	Max
Leather group 4	Nubuck, Vegeta, Cera

Model 450G

Delphi Elements Configuration G, 320 x 145cm

Modeldetails

835 m³ Packaging dimensions:
158 kg / L: 96/95/96 cm W: 65/64/65 cm H:
137 kg 151/100/151 cm

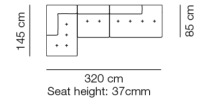

Designed by Hannes Wettstein, 2007

Delphi modular sofa system. Fully upholstered in fabric or leather with non-removable cover. Inner frame of wood with nozag springs, cold cured foam, either HR or CMHR foam and duvet of cut foam and fibers. Aluminum or solid wood base. Modules can be independently rearranged.

Order configuration

Base: Brushed aluminium, black or Oak light oil.

Plinth: Same as other upholstery or leather (98 black, 95 cognac, 90 natural).

Fabric group 1	8.310
Fabric group 2	8.775
Fabric group 3	9.225
Fabric group 4	9.900
Fabric group 5	11.515
C.O.M. fabric	8.310
Leather group 1	11.225
Leather group 2	12.290
Leather group 3	14.000
Leather group 4	16.320
Leather group 5	20.355
C.O.M. leather	11.225

Fabric consumption: 11,6 m. Leather consumption: 30 m²

Extra charge for

Leather plinth if upholstery is in fabric:	+1.250
Extra sitting height (2,5 cm):	+615

Recommended upholstery

Fabric group 1	Remix, Capture, Bardal, Re-wool, Linara, Erik, Natural Linen
Fabric group 2	Hallingdal, Barnum, Loop, Steelcut Trio, Fiord, Ruskin
Fabric group 3	Divina Melange, Vidar, Clay
Fabric group 4	Elle, Sisu, Safire
Fabric group 5	Gentle
Leather group 1	Omni
Leather group 2	Primo, Trace
Leather group 3	Max
Leather group 4	Nubuck, Vegeta, Cera

Model 450H

Delphi Elements Configuration H, 320 x 145cm

Modeldetails

901,8 m³ Packaging dimensions:
158 kg / L: 96/95/96 cm W: 65/64/65 cm H:
137 kg 151/100/151 cm



Designed by Hannes Wettstein, 2007

Delphi modular sofa system. Fully upholstered in fabric or leather with non-removable cover. Inner frame of wood with nozag springs, cold cured foam, either HR or CMHR foam and duvet of cut foam and fibers. Aluminum or solid wood base. Modules can be independently rearranged.

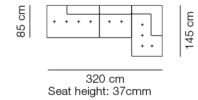

Order configuration

Base: Brushed aluminium, black or Oak light oil.

Plinth: Same as other upholstery or leather (98 black, 95 cognac, 90 natural).

Fabric group 1	8.310
Fabric group 2	8.775
Fabric group 3	9.225
Fabric group 4	9.900
Fabric group 5	11.515
C.O.M. fabric	8.310
Leather group 1	11.225
Leather group 2	12.290
Leather group 3	14.000
Leather group 4	16.320
Leather group 5	20.355
C.O.M. leather	11.225

Fabric consumption: 11,6 m. Leather consumption: 30 m²

Extra charge for

Leather plinth if upholstery is in fabric:	+1.250
Extra sitting height (2,5 cm):	+615

Recommended upholstery

Fabric group 1	Remix, Capture, Bardal, Re-wool, Linara, Erik, Natural Linen
Fabric group 2	Hallingdal, Barnum, Loop, Steelcut Trio, Fiord, Ruskin
Fabric group 3	Divina Melange, Vidar, Clay
Fabric group 4	Elle, Sisu, Safire
Fabric group 5	Gentle
Leather group 1	Omni
Leather group 2	Primo, Trace
Leather group 3	Max
Leather group 4	Nubuck, Vegeta, Cera

Delphi Elements – overview

4501 End module 120x85 cm, Arm L or R

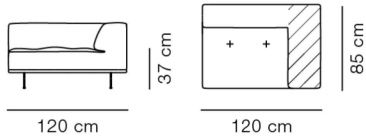
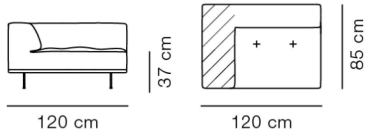

4514 End module 180x85 cm, Arm L or R

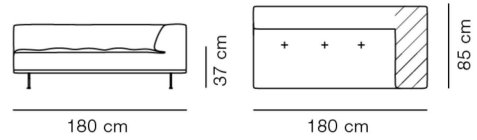
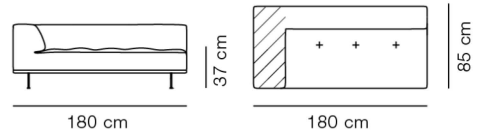

4515 Chaise lounge, L or R 145x90 cm

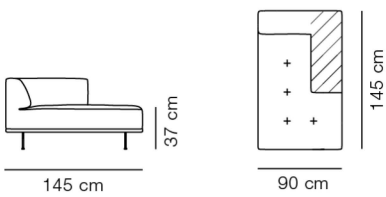
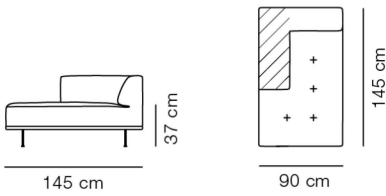

4517 Open-end, L or R 145x85 cm

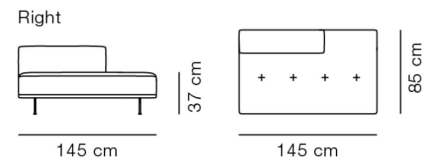
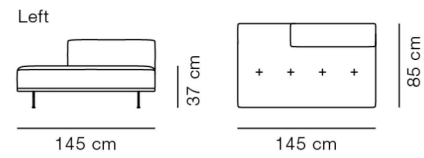

4502 Seat module 120x85 cm

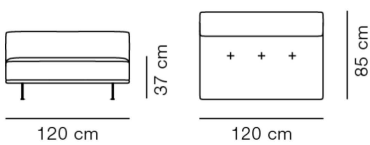

4506 Seat module 85x85 cm

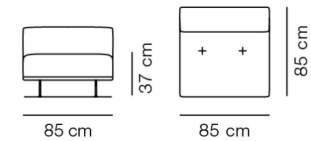

4503 Side chaise module 120x85 cm

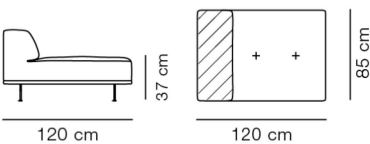

*Extended arm

4513 Corner module 85x85 cm

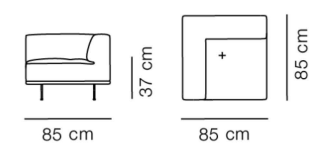

4504 Ottoman 120x85 cm

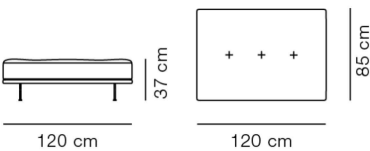

4505 Ottoman 85x85 cm

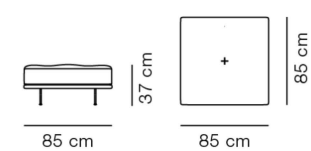

Delphi Elements – Configuration overview

Model 450A, Configuration A
MODEL 4504 / 4501 (left) / 4506 / 4501 (right)

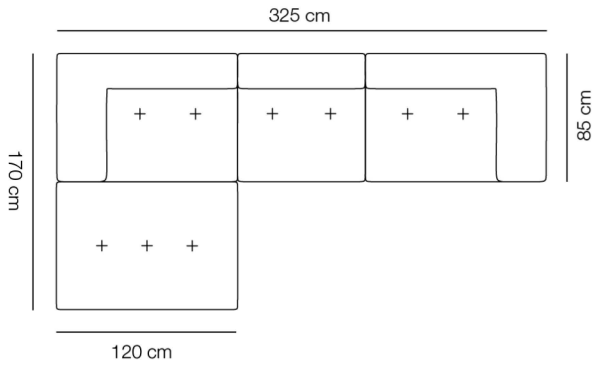

Model 450B, Configuration B
MODEL 4501 (left) / 4513 / 4514 (right)

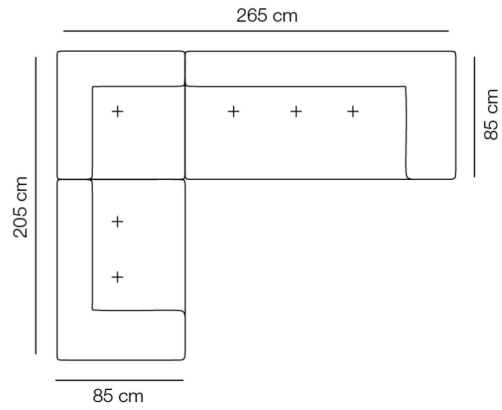

Model 450C, Configuration C
MODEL 4503 / 4503 / 4501 (left) / 4502 / 4501 (right)

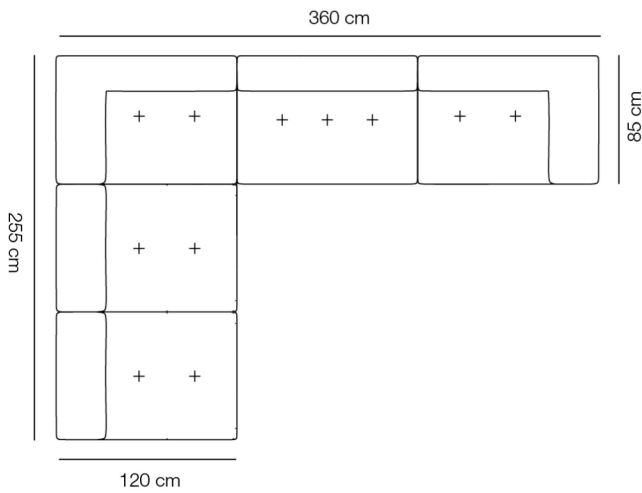

Model 450D, Configuration D
MODEL 4514 (left) / 4513 / 4501 (right)

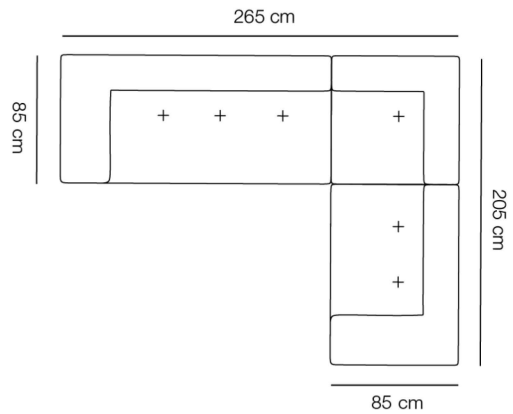

Model 450E, Configuration E
MODEL 4515 (left) / 4517 (right)

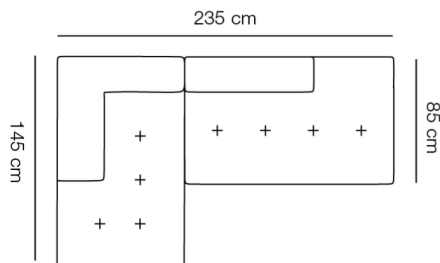

Model 450F, Configuration F
MODEL 4517 (left) / 4515 (right)

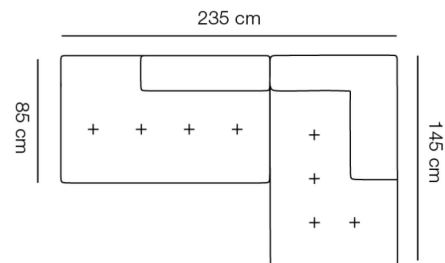

For customer's own configuration, please attach to the order a visual sketch of the desired layout

Delphi Elements – Configuration overview

Model 450G, Configuration G
MODEL 4515 (left) / 4506 / 4517 (right)

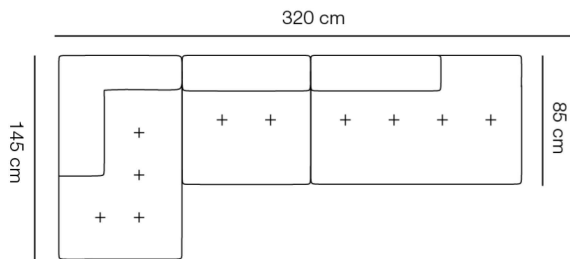

Model 450H, Configuration H
MODEL 4517 (left) / 4506 / 4515 (right)

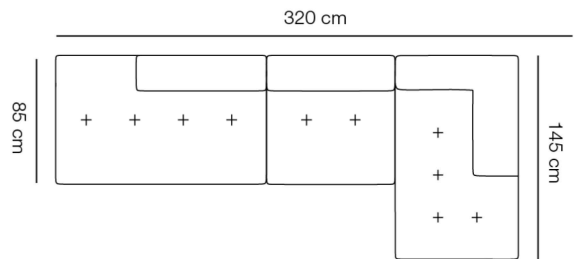

Model 2042

EJ220 Sofa 163 cm, 2 seater



Designed by Erik Jørgensen, 1970

Sofa with separate seat and back cushions, width 76 cm with loose arm cushions. Inner frame of wood with nozag springs. Available in fabric or leather. Cushions available in foam core, either HR or CMHR foam with down wrap. Cushions in fabric are reversible. External cover available as non-removable. Cushion covers are removable. Legs in solid wood or steel.

Modeldetails

1 m³ Packaging dimensions:
49 kg / 42 kg L: 168 cm W: 95 cm H: 64 cm

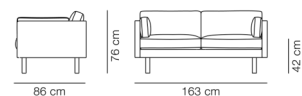

Essential Assortment

Pre-configured

Item number	Upholstery	Legs	Price
20421930018021203110	Re-Wool 198	Oak soap treated, FSC Mix 70%	3.355
20421931118021203110	Re-Wool 128	Oak soap treated, FSC Mix 70%	3.355
20424064018021203110	Erik 3790 Linen	Oak soap treated, FSC Mix 70%	3.355
20424064218021203110	Erik 9998 Broken Grey	Oak soap treated, FSC Mix 70%	3.355
20425130118021704110	Leather Omni 301, Black	Brushed chrome, round legs	6.660
20425009518021704110	Leather Max 95, Cognac	Brushed chrome, round legs	9.255

Essential variants only delivered with HR foam

Order configuration

Cushion filling: Down cover.

Legs: Round wooden legs in either Oak soap, Oak lacquered or Smoked oak stain

Round steel legs in either Brushed chrome or Black powder coat.

Fabric group 1	3.355
Fabric group 2	3.930
Fabric group 3	4.210
Fabric group 4	5.045
Fabric group 5	6.055
C.O.M. fabric	3.355
Leather group 1	6.660
Leather group 2	7.675
Leather group 3	9.255
Leather group 4	10.040
Leather group 5	11.550
C.O.M. leather	6.660

Fabric consumption: 9,8 m. Leather consumption: 19,5 m²

Extra charge for

Removable cover (fabric only) add 1 m extra in Fabric consumption: +355

Certifications

Oak is FSC® certified

EN 1022:2005, EN 16139:2013 (L2)

Recommended upholstery

Fabric group 1	Gran Linen, Remix, Re-wool, Linara, Natural Linen, Erik, Capture, Bardal
Fabric group 2	Hallingdal, Barnum, Steelcut Trio, Ruskin, Savoy, Loop, Fiord
Fabric group 3	Divina Melange, Vidar, Sunniva, Clay
Fabric group 4	Cotil, Sisu, Safire, Elle
Fabric group 5	Grand Mohair, Gentle
Leather group 1	Omni
Leather group 2	Primo, Trace
Leather group 3	Max
Leather group 4	Nubuck, Vegeta, Organic, Cera

Model 2052

EJ220 Sofa 185 cm, 2½ seater



Designed by Erik Jørgensen, 1970

Sofa with separate seat and back cushions, width 86 cm with loose arm cushions. Inner frame of wood with nozag springs. Available in fabric or leather. Cushions available in foam core, either HR or CMHR foam with down wrap. Cushions in fabric are reversible. External cover available as non-removable (standard) or removable. Cushion covers are removable. Legs in solid wood or steel.

Modeldetails

1,15 m³ Packaging dimensions:
54 kg / 47 kg L: 217 cm W: 95 cm H: 64 cm

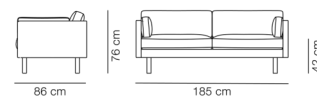

Essential Assortment

Pre-configured

Item number	Upholstery	Legs	Price
20521930018021203110	Re-Wool 198	Oak soap treated, FSC Mix 70%	3.645
20521931118021203110	Re-Wool 128	Oak soap treated, FSC Mix 70%	3.645
20524064018021203110	Erik 3790 Linen	Oak soap treated, FSC Mix 70%	3.645
20524064218021203110	Erik 9998 Broken Grey	Oak soap treated, FSC Mix 70%	3.645
20525130118021704110	Leather Omni 301, Black	Brushed chrome, round legs	7.230
20525009518021704110	Leather Max 95, Cognac	Brushed chrome, round legs	10.050

Essential variants only delivered with HR foam

Order configuration

Cushion filling: Down cover.

Legs: Round wooden legs in either Oak soap, Oak lacquered or Smoked oak stain

Round steel legs in either Brushed chrome or Black powder coat.

Fabric group 1	3.645
Fabric group 2	4.270
Fabric group 3	4.575
Fabric group 4	5.480
Fabric group 5	6.575
C.O.M. fabric	3.645
Leather group 1	7.230
Leather group 2	8.335
Leather group 3	10.050
Leather group 4	10.905
Leather group 5	12.540
C.O.M. leather	7.230

Fabric consumption: 9,5 m. Leather consumption: 19,5 m²

Extra charge for

Removable cover (fabric only) add 1 m extra in Fabric consumption: +355

Certifications

Oak is FSC® certified

EN 1022:2005, EN 16139:2013 (L2)

Recommended upholstery

Fabric group 1	Erik, Remix, Gran Linen, Capture, Natural Linen, Bardal, Re-wool, Linara
Fabric group 2	Steelcut Trio, Hallingdal, Barnum, Loop, Fiord, Ruskin, Savoy
Fabric group 3	Vidar, Sunniva, Divina Melange, Clay
Fabric group 4	Elle, Cotil, Sisu, Safire
Fabric group 5	Gentle, Grand Mohair
Leather group 1	Omni
Leather group 2	Primo, Trace
Leather group 3	Max
Leather group 4	Nubuck, Vegeta, Organic, Cera

Model 2062

EJ220 Sofa 212 cm, 3 seater



Designed by Erik Jørgensen, 1970

Sofa with separate seat and back cushions, width 100 cm with loose arm cushions. Inner frame of wood with nozag springs. Available in fabric or leather. Cushions available in foam core, either HR or CMHR foam with down wrap. Cushions in fabric are reversible. External cover available as non-removable (standard) or removable. Cushion covers are removable. Legs in solid wood or steel.

Modeldetails

1,33 m³ Packaging dimensions:
63 kg / L: 217 cm W: 95 cm H: 64 cm
57 kg

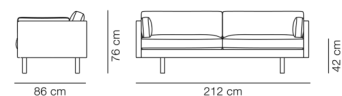

Essential Assortment

Pre-configured

Item number	Upholstery	Legs	Price
20621930018021203110	Re-Wool 198	Oak soap treated, FSC Mix 70%	4.170
20621931118021203110	Re-Wool 128	Oak soap treated, FSC Mix 70%	4.170
20624064018021203110	Erik 3790 Linen	Oak soap treated, FSC Mix 70%	4.170
20624064218021203110	Erik 9998 Broken Grey	Oak soap treated, FSC Mix 70%	4.170
20625130118021704110	Leather Omni 301, Black	Brushed chrome, round legs	8.290
20625009518021704110	Leather Max 95, Cognac	Brushed chrome, round legs	11.525

Essential variants only delivered with HR foam

Order configuration

Cushion filling: Down cover.

Legs: Round wooden legs in either Oak soap, Oak lacquered or Smoked oak stain

Round steel legs in either Brushed chrome or Black powder coat.

Fabric group 1	4.170
Fabric group 2	4.890
Fabric group 3	5.235
Fabric group 4	6.275
Fabric group 5	7.530
C.O.M. fabric	4.170
Leather group 1	8.290
Leather group 2	9.555
Leather group 3	11.525
Leather group 4	12.500
Leather group 5	14.375
C.O.M. leather	8.290

Fabric consumption: 10,5 m. Leather consumption: 20 m²

Alternative leg placement is possible.

Extra charge for

Removable cover (fabric only) add 1 m extra in Fabric consumption: +355

Certifications

Oak is FSC® certified

EN 1022:2005, EN 16139:2013 (L2)

Recommended upholstery

Fabric group 1	Remix, Capture, Bardal, Re-wool, Linara, Natural Linen, Erik, Gran Linen
Fabric group 2	Steelcut Trio, Ruskin, Savoy, Hallingdal, Barnum, Loop, Fiord
Fabric group 3	Vidar, Sunniva, Clay, Divina Melange
Fabric group 4	Elle, Sisu, Safire, Cotil
Fabric group 5	Grand Mohair, Gentle
Leather group 1	Omni
Leather group 2	Primo, Trace
Leather group 3	Max
Leather group 4	Nubuck, Vegeta, Organic, Cera

Model 2033

EJ220 Sofa 212 cm, 3 seater



Designed by Erik Jørgensen, 1970

Sofa with separate seat and back cushions, width 67 cm with loose arm cushions. Inner frame of wood with nozag springs. Available in fabric or leather. Cushions available in foam core, either HR or CMHR foam with down wrap. Cushions in fabric are reversible. External cover available as non-removable (standard) or removable. Cushion covers are removable. interchangeable legs in solid wood or steel.

Modeldetails

1,32 m³ Packaging dimensions:
63 kg / L: 217 cm W: 95 cm H: 64 cm
57 kg

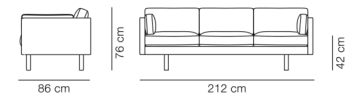

Essential Assortment

Pre-configured

Item number	Upholstery	Legs	Price
20331930018021203110	Re-Wool 198	Oak soap treated, FSC Mix 70%	4.215
20331931118021203110	Re-Wool 128	Oak soap treated, FSC Mix 70%	4.215
20334064018021203110	Erik 3790 Linen	Oak soap treated, FSC Mix 70%	4.215
20334064218021203110	Erik 9998 Broken Grey	Oak soap treated, FSC Mix 70%	4.215
20335130118021704110	Leather Omni 301, Black	Brushed chrome, round legs	8.375
20335009518021704110	Leather Max 95, Cognac	Brushed chrome, round legs	11.645

Essential variants only delivered with HR foam

Order configuration

Cushion filling: Down cover.

Legs: Round wooden legs in either Oak soap, Oak lacquered or Smoked oak stain

Round steel legs in either Brushed chrome or Black powder coat.

Fabric group 1	4.215
Fabric group 2	4.940
Fabric group 3	5.290
Fabric group 4	6.340
Fabric group 5	7.610
C.O.M. fabric	4.215
Leather group 1	8.375
Leather group 2	9.655
Leather group 3	11.645
Leather group 4	12.635
Leather group 5	14.530
C.O.M. leather	8.375

Fabric consumption: 10,5 m. Leather consumption: 24 m²

Alternative leg placement is possible.

Extra charge for

Removable cover (fabric only) add 1 m extra in Fabric consumption: +355

Certifications

Oak is FSC® certified

EN 1022:2005, EN 16139:2013 (L2)

Recommended upholstery

Fabric group 1	Remix, Capture, Bardal, Re-wool, Linara, Natural Linen, Erik, Gran Linen
Fabric group 2	Steelcut Trio, Ruskin, Savoy, Hallingdal, Barnum, Loop, Fiord
Fabric group 3	Vidar, Sunniva, Clay, Divina Melange
Fabric group 4	Elle, Sisu, Safire, Cotil
Fabric group 5	Grand Mohair, Gentle
Leather group 1	Omni
Leather group 2	Primo, Trace
Leather group 3	Max
Leather group 4	Nubuck, Vegeta, Organic, Cera

Model 8052

EJ280 Sofa 212 cm, 2½ seater



Designed by Erik Jørgensen Studio, 2010

Sofa with separate seat and back cushions, width 86 cm with loose arm cushions. Inner frame of wood with nozag springs. Available in fabric or leather. Cushions in foam core, either HR or CMHR foam with down wrap. External cover available as non-removable (standard) or removable. Cushion covers are removable. Sledge legs in steel in two different heights, or legs in solid wood or steel. Available in two heights, please specify height.

Modeldetails

1,3 m³ Packaging dimensions:
63 kg / L: 217 cm W: 95 cm H: 64 cm
57 kg



Essential Assortment

Pre-configured

Item number	Upholstery	Legs	Price
80521930017021711010	Re-Wool 198	Brushed chrome, sledge base (High)	4.185
80521931117021711010	Re-Wool 128	Brushed chrome, sledge base (High)	4.185
80524064017021711010	Erik 3790 Linen	Brushed chrome, sledge base (High)	4.185
80524064217021711010	Erik 9998 Broken Grey	Brushed chrome, sledge base (High)	4.185
80525130117021711010	Leather Omni 301, Black	Brushed chrome, sledge base (High)	8.045
80525009517021711010	Leather Max 95, Cognac	Brushed chrome, sledge base (High)	11.170

Essential variants only delivered with HR foam

Order configuration

Legs: Round wooden legs in either oak soap, oak lacquer or oak smoke stained.

Round steel legs in either brushed chrome or black powder coating.

Metal frame in brushed chrome.

Fabric group 1	4.185
Fabric group 2	4.875
Fabric group 3	5.205
Fabric group 4	6.200
Fabric group 5	7.440
C.O.M. fabric	4.185
Leather group 1	8.045
Leather group 2	9.270
Leather group 3	11.170
Leather group 4	12.110
Leather group 5	13.930
C.O.M. leather	8.045

Fabric consumption: 10,8 m. Leather consumption: 20 m²

Extra charge for

Removable cover (fabric only) add 1 m extra in Fabric consumption: +355

Certifications

Oak is FSC® certified

EN 1022:2005, EN 16139:2013 (L2)

Recommended upholstery

Fabric group 1	Gran Linen, Remix, Capture, Natural Linen, Erik, Bardal, Re-wool, Linara
Fabric group 2	Steelcut Trio, Hallingdal, Barnum, Loop, Fiord, Ruskin, Savoy
Fabric group 3	Vidar, Sunniva, Divina Melange, Clay
Fabric group 4	Elle, Cotil, Sisu, Safire
Fabric group 5	Gentle, Grand Mohair
Leather group 1	Omni
Leather group 2	Primo
Leather group 3	Max
Leather group 4	Nubuck, Vegeta, Organic, Cera

Model 8062

EJ280 Sofa 240 cm, 3 seater



Designed by Erik Jørgensen Studio, 2010

Sofa with separate seat and back cushions, width 100 cm with loose arm cushions. Inner frame of wood with nozag springs. Available in fabric or leather. Cushions in foam core, either HR or CMHR foam with down wrap. Cushions in fabric are reversible. External cover available as non-removable (standard) or removable. Cushion covers are removable. Sledge legs in steel in two different heights, or legs in solid wood or steel. Available in two heights, please specify height.

Modeldetails

1,49 m³ Packaging dimensions:
68 kg / L: 245 cm W: 95 cm H: 64 cm
62 kg

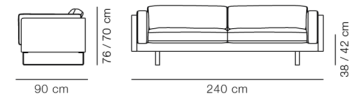

Essential Assortment

Pre-configured

Item number	Upholstery	Legs	Price
80621930017021711010	Re-Wool 198	Brushed chrome, sledge base (High)	4.635
80621931117021711010	Re-Wool 128	Brushed chrome, sledge base (High)	4.635
80624064017021711010	Erik 3790 Linen	Brushed chrome, sledge base (High)	4.635
80624064217021711010	Erik 9998 Broken Grey	Brushed chrome, sledge base (High)	4.635
80625130117021711010	Leather Omni 301, Black	Brushed chrome, sledge base (High)	8.975
80625009517021711010	Leather Max 95, Cognac	Brushed chrome, sledge base (High)	12.445

Essential variants only delivered with HR foam

Order configuration

Legs: Round wooden legs in either oak soap, oak lacquer or oak smoke stained.

Round steel legs in either brushed chrome or black powder coating.

Metal frame in brushed chrome.

Fabric group 1	4.635
Fabric group 2	5.375
Fabric group 3	5.730
Fabric group 4	6.795
Fabric group 5	8.155
C.O.M. fabric	4.635
Leather group 1	8.975
Leather group 2	10.330
Leather group 3	12.445
Leather group 4	13.490
Leather group 5	15.515
C.O.M. leather	8.975

Fabric consumption: 11,5 m. Leather consumption: 23,5 m²

Extra charge for

Removable cover (fabric only) add 1 m extra in Fabric consumption: +355

Certifications

Oak is FSC® certified

EN 1022:2005, EN 16139:2013 (L2)

Recommended upholstery

Fabric group 1	Erik, Gran Linen, Re-wool, Remix, Capture, Bardal, Linara, Natural Linen
Fabric group 2	Steelcut Trio, Fiord, Savoy, Hallingdal, Ruskin, Barnum, Loop
Fabric group 3	Vidar, Divina Melange, Sunniva, Clay
Fabric group 4	Elle, Safire, Sisu, Cotil
Fabric group 5	Grand Mohair, Gentle

Model 8072

EJ280 Sofa 280 cm, 3 seater



Designed by Erik Jørgensen Studio, 2010

Sofa delivered in two modules with separate seat and back cushions, width 120 cm with loose arm cushions. Inner frame of wood with nozag springs. Available in fabric. Cushions in foam core, either HR or CMHR foam with down wrap. Cushions in fabric are reversible. External cover available as non-removable (standard) or removable. Cushion covers are removable. Sledge legs in steel in two different heights, or legs in solid wood or steel. Available in two heights, please specify height.

Modeldetails

1,7 m³ Packaging dimensions:
81 kg / 75 kg L: 285 cm W: 95 cm H: 64 cm

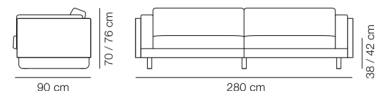

Essential Assortment

Pre-configured

Item number	Upholstery	Legs	Price
807219300170217110A0	Re-Wool 198	Brushed chrome, sledge base (High)	6.180
807219311170217110A0	Re-Wool 128	Brushed chrome, sledge base (High)	6.180
807240640170217110A0	Erik 3790 Linen	Brushed chrome, sledge base (High)	6.180
807240642170217110A0	Erik 9998 Broken Grey	Brushed chrome, sledge base (High)	6.180

Essential variants only delivered with HR foam

Order configuration

Legs: Round wooden legs in either oak soap, oak lacquer or oak smoke stained.

Round steel legs in either brushed chrome or black powder coating.

Metal frame in brushed chrome.

Fabric group 1	6.180
Fabric group 2	6.835
Fabric group 3	7.495
Fabric group 4	8.770
Fabric group 5	10.125
C.O.M. fabric	6.180

Fabric consumption: 13,1 m

Extra charge for

Removable cover (fabric only) add 1 m extra in Fabric consumption: +355

Certifications

Oak is FSC® certified

EN 1022:2005, EN 16139:2013 (L2)

Recommended upholstery

Fabric group 1	Gran Linen, Linara, Bardal, Capture, Remix, Natural Linen, Re-wool, Erik
Fabric group 2	Hallingdal, Savoy, Barnum, Fiord, Steelcut Trio, Ruskin, Loop
Fabric group 3	Vidar, Clay, Sunniva, Divina Melange
Fabric group 4	Sisu, Elle, Safire, Cotil
Fabric group 5	Gentle, Grand Mohair

Model 809B

EJ280 Elements Configuration B, 290 x 290cm

Modeldetails

2,81 m³ Packaging dimensions:
159 kg / L: 96/96/96 cm W: 65/65/65 cm H:
144 kg 177/98/177 cm



Designed by Erik Jørgensen Studio, 2018

Available in fabric only. The external cover is non-removable. Cushion covers are removable. Cushions in foam core, either HR or CMHR foam with down wrap. Cushions in fabric are reversible. Sledge legs in steel in two different heights, or legs in solid wood or steel. Available in two heights, please specify height.

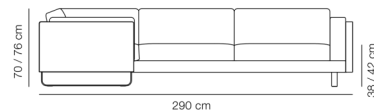

Order configuration

Legs: Round wooden legs in either oak soap, oak lacquer or oak smoke stained.

Round steel legs in either brushed chrome or black powder coating.

Metal frame in brushed chrome.

Fabric group 1	9.460
Fabric group 2	11.070
Fabric group 3	11.845
Fabric group 4	14.175
Fabric group 5	17.010
C.O.M. fabric	9.460

Fabric consumption: 20,3 m

Certifications

Oak is FSC® certified

EN 1022:2005, EN 16139:2013 (L2)

Recommended upholstery

Fabric group 1	Gran Linen, Linara, Bardal, Capture, Remix, Natural Linen, Re-wool, Erik
Fabric group 2	Savoy, Barnum, Steelcut Trio, Fiord, Hallingdal, Ruskin, Loop
Fabric group 3	Vidar, Clay, Sunniva, Divina Melange
Fabric group 4	Sisu, Elle, Safire, Cotil
Fabric group 5	Gentle, Grand Mohair

Model 809C

EJ280 Elements Configuration C, 318 x 318cm



Designed by Erik Jørgensen Studio, 2018

Available in fabric only. The external cover is non-removable. Cushion covers are removable. Cushions in foam core, either HR or CMHR foam with down wrap. Cushions in fabric are reversible. Sledge legs in steel in two different heights, or legs in solid wood or steel. Available in two heights, please specify height.

Modeldetails

3,17 m³ Packaging dimensions:
183 kg / L: 96/96/96 cm W: 65/65/65 cm H:
166 kg 68/30/68 cm

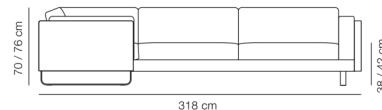

Order configuration

Legs: Round wooden legs in either oak soap, oak lacquer or oak smoke stained.

Round steel legs in either brushed chrome or black powder coating.

Metal frame in brushed chrome.

Fabric group 1	9.970
Fabric group 2	11.660
Fabric group 3	12.475
Fabric group 4	14.915
Fabric group 5	17.910
C.O.M. fabric	9.970

Fabric consumption: 21,9 m

Certifications

Oak is FSC® certified

EN 1022:2005, EN 16139:2013 (L2)

Recommended upholstery

Fabric group 1	Gran Linen, Remix, Capture, Bardal, Re-wool, Linara, Natural Linen, Erik
Fabric group 2	Hallingdal, Ruskin, Barnum, Steelcut Trio, Fiord, Loop, Savoy
Fabric group 3	Vidar, Divina Melange, Sunniva, Clay
Fabric group 4	Sisu, Safire, Elle, Cotil
Fabric group 5	Grand Mohair, Gentle

Model 809D

EJ280 Elements Configuration D, 318cm x 218cm

Designed by Erik Jørgensen Studio, 2018

Available in fabric only. The external cover is non-removable. Cushion covers are removable. Cushions in foam core, either HR or CMHR foam with down wrap. Cushions in fabric are reversible. Sledge legs in steel in two different heights, or legs in solid wood or steel. Available in two heights, please specify height.

Modeldetails

2,55 m³ Packaging dimensions:
159 kg / L: 96/96/96 cm W: 65/65/65 cm H:
143 kg 105/98/205 cm

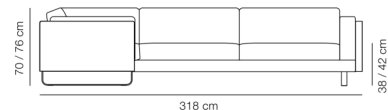

Order configuration

Legs: Round wooden legs in either oak soap, oak lacquer or oak smoke stained.

Round steel legs in either brushed chrome or black powder coating.

Metal frame in brushed chrome.

Fabric group 1	8.355
Fabric group 2	9.700
Fabric group 3	10.345
Fabric group 4	12.280
Fabric group 5	14.745
C.O.M. fabric	8.355

Fabric consumption: 18,5 m

Certifications

Oak is FSC® certified

EN 1022:2005, EN 16139:2013 (L2)

Recommended upholstery

Fabric group 1	Gran Linen, Linara, Bardal, Capture, Remix, Natural Linen, Re-wool, Erik
Fabric group 2	Savoy, Barnum, Steelcut Trio, Loop, Fiord, Hallingdal, Ruskin
Fabric group 3	Vidar, Clay, Sunniva, Divina Melange
Fabric group 4	Sisu, Safire, Cotil, Elle
Fabric group 5	Gentle, Grand Mohair

Model 809E

EJ280 Elements Configuration E, 318 x 218cm

Designed by Erik Jørgensen Studio, 2018

Available in fabric only. The external cover is non-removable. Cushion covers are removable. Cushions in foam core, either HR or CMHR foam with down wrap. Cushions in fabric are reversible. Sledge legs in steel in two different heights, or legs in solid wood or steel. Available in two heights, please specify height.

Modeldetails

2,55 m³ Packaging dimensions:
159 kg / L: 96/96/96 cm W: 65/65/65 cm H:
143 kg 205/98/105 cm

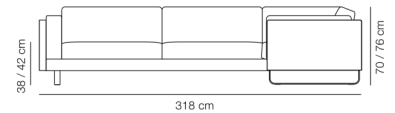

Order configuration

Legs: Round wooden legs in either oak soap, oak lacquer or oak smoke stained.

Round steel legs in either brushed chrome or black powder coating.

Metal frame in brushed chrome.

Fabric group 1	8.355
Fabric group 2	9.700
Fabric group 3	10.345
Fabric group 4	12.280
Fabric group 5	14.745
C.O.M. fabric	8.355

Fabric consumption: 18,5 m

Certifications

Oak is FSC® certified

EN 1022:2005, EN 16139:2013 (L2)

Recommended upholstery

Fabric group 1	Gran Linen, Remix, Capture, Bardal, Re-wool, Linara, Natural Linen, Erik
Fabric group 2	Hallingdal, Barnum, Fiord, Loop, Steelcut Trio, Ruskin, Savoy
Fabric group 3	Divina Melange, Sunniva, Vidar, Clay
Fabric group 4	Cotil, Elle, Sisu, Safire
Fabric group 5	Grand Mohair, Gentle

Model 8099

EJ280 Elements Corner module 98x98 cm

Modeldetails

0,61 m³ Packaging dimensions:
35 kg / 30 kg L: 96 cm W: 65 cm H: 98 cm



Designed by Erik Jørgensen Studio, 2018

Corner module for EJ280 Elements, including cushions. Available in fabric only. Cushions in fabric are reversible. The external cover is non-removable. Cushion covers are removable. Cushions in foam core, either HR or CMHR foam with down wrap. Legs in solid wood or steel according to defined configuration. Modules cannot be rearranged after configuration. Available in two heights, please specify height.

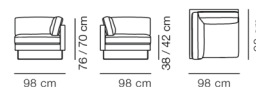

Order configuration

Legs: Round wooden legs in either oak soap, oak lacquer or oak smoke stained.

Round steel legs in either brushed chrome or black powder coating.

Metal frame in brushed chrome.

Fabric group 1	1.720
Fabric group 2	2.040
Fabric group 3	2.195
Fabric group 4	2.655
Fabric group 5	3.190
C.O.M. fabric	1.720

Fabric consumption: 4,3 m

Certifications

Oak is FSC® certified

EN 1022:2005, EN 16139:2013 (L2)

Recommended upholstery

Fabric group 1	Gran Linen, Remix, Linara, Natural Linen, Erik, Capture, Bardal, Re-wool
Fabric group 2	Hallingdal, Barnum, Fiord, Steelcut Trio, Ruskin, Savoy, Loop
Fabric group 3	Divina Melange, Sunniva, Clay, Vidar
Fabric group 4	Cotil, Sisu, Safire, Elle
Fabric group 5	Gentle, Grand Mohair

Model 8066

EJ280 Elements End module, 1 seater, Arm L or R

Modeldetails

0,66 m³ Packaging dimensions:
50 kg / 45 kg L: 96 cm W: 65 cm H: 105 cm



Designed by Erik Jørgensen Studio, 2018

End module for EJ280 Elements, including cushions and arm in one side. Available in fabric only. Cushions in foam core, either HR or CMHR foam with down wrap. Cushions in fabric are reversible, width 100 cm. The external cover is non-removable. Cushion covers are removable. Sledge legs in steel, or legs in solid wood or steel. Please specify height and arm position left or right hand side, facing the sofa. Available in two heights, please specify height.

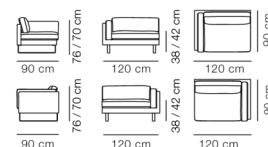

Order configuration

Legs: Round wooden legs in either oak soap, oak lacquer or oak smoke stained.

Round steel legs in either brushed chrome or black powder coating.

Metal frame in brushed chrome.

Fabric group 1	2.510
Fabric group 2	2.850
Fabric group 3	3.010
Fabric group 4	3.495
Fabric group 5	4.195
C.O.M. fabric	2.510

Fabric consumption: 5,4 m

Certifications

Oak is FSC® certified

EN 1022:2005, EN 16139:2013 (L2)

Recommended upholstery

Fabric group 1	Gran Linen, Remix, Capture, Bardal, Re-wool, Linara, Natural Linen, Erik
Fabric group 2	Hallingdal, Barnum, Loop, Steelcut Trio, Fiord, Ruskin, Savoy
Fabric group 3	Vidar, Sunniva, Divina Melange, Clay
Fabric group 4	Cotil, Elle, Sisu, Safire
Fabric group 5	Grand Mohair, Gentle

Model 8057

EJ280 Elements End module, 2 seater, Arm L or R



Designed by Erik Jørgensen Studio, 2018

End module for EJ280 Elements, including cushions and arm in one side. Available in fabric only. Cushions in foam core, either HR or CMHR foam with down wrap. Cushions in fabric are reversible, width 86 cm. The external cover is non-removable. Cushion covers are removable. Please specify height and arm position left or right hand side, facing the sofa.

Model details

1,1 m³ Packaging dimensions:
62 kg / 57 kg L: 96 cm W: 65 cm H: 177 cm

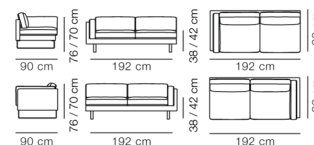

Order configuration

Legs: Round wooden legs in either oak soap, oak lacquer or oak smoke stained.

Round steel legs in either brushed chrome or black powder coating.

Metal frame in brushed chrome.

Fabric group 1	3.870
Fabric group 2	4.515
Fabric group 3	4.825
Fabric group 4	5.760
Fabric group 5	6.910
C.O.M. fabric	3.870

Fabric consumption: 8 m

Certifications

Oak is FSC® certified

EN 1022:2005, EN 16139:2013 (L2)

Recommended upholstery

Fabric group 1	Gran Linen, Remix, Bardal, Re-wool, Linara, Natural Linen, Erik, Capture
Fabric group 2	Hallingdal, Barnum, Steelcut Trio, Ruskin, Savoy, Loop, Fiord
Fabric group 3	Vidar, Sunniva, Clay, Divina Melange
Fabric group 4	Sisu, Safire, Cotil, Elle
Fabric group 5	Grand Mohair, Gentle

Model 8067

EJ280 Elements End module, 2 seater, Arm L or R



Designed by Erik Jørgensen Studio, 2018

End module for EJ280 Elements, including cushions and arm in one side. Available in fabric only. Cushions in foam core, either HR or CMHR foam with down wrap. Cushions in fabric are reversible, width 100 cm. The external cover is non-removable. Cushion covers are removable. Sledge legs in steel, or legs solid in wood or steel. Please specify height and arm position left or right hand side, facing the sofa.

Modeldetails

1,28 m³ Packaging dimensions:
68 kg / 62 kg L: 96 cm W: 65 cm H: 205 cm

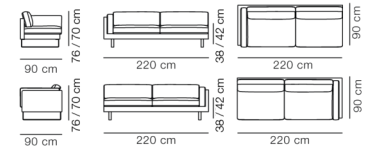

Order configuration

Legs: Round wooden legs in either oak soap, oak lacquer or oak smoke stained.

Round steel legs in either brushed chrome or black powder coating.

Metal frame in brushed chrome.

Fabric group 1	4.125
Fabric group 2	4.810
Fabric group 3	5.140
Fabric group 4	6.130
Fabric group 5	7.360
C.O.M. fabric	4.125

Fabric consumption: 8,8 m

Certifications

Oak is FSC® certified

EN 1022:2005, EN 16139:2013 (L2)

Recommended upholstery

Fabric group 1	Gran Linen, Remix, Bardal, Re-wool, Linara, Natural Linen, Erik, Capture
Fabric group 2	Hallingdal, Barnum, Steelcut Trio, Ruskin, Savoy, Loop, Fiord
Fabric group 3	Vidar, Sunniva, Clay, Divina Melange
Fabric group 4	Sisu, Safire, Cotil, Elle
Fabric group 5	Grand Mohair, Gentle

EJ280 Elements - Overview

Model 809B, Configuration B
8057 L / 8099 / 8057 R

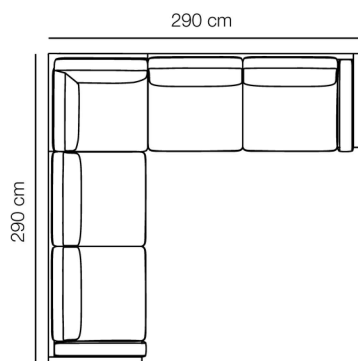

Model 809C, Configuration C
8067 L / 8099 / 8067 R

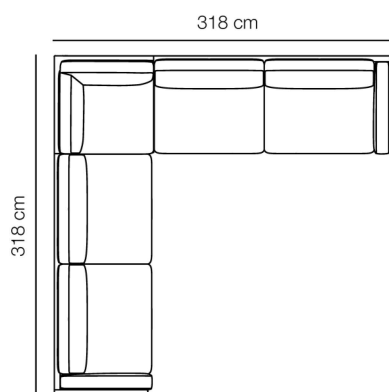



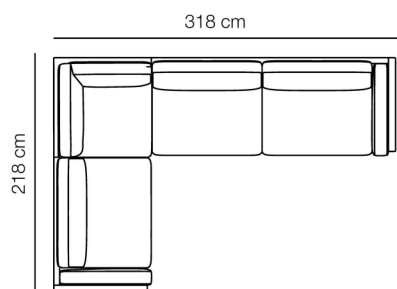

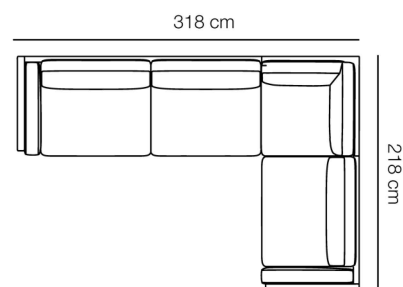

Model 809D, Configuration D
8066 L / 8099 / 8067 R



Model 809E, Configuration E
8067 L / 8099 / 8066 R

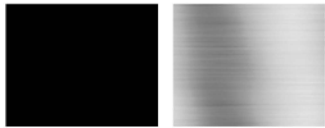

Erik Jørgensen Sofa Collection – Base options

Material	Type	Available for
 <p data-bbox="108 609 336 636">Brushed chrome Black</p>		<p data-bbox="1291 479 1453 528">EJ280 Sofa EJ280 Elements</p> <p data-bbox="1291 555 1453 604">Base available in two heights</p>
 <p data-bbox="108 828 434 855">Black Brushed chrome</p>		<p data-bbox="1291 698 1453 770">EJ220 Sofa EJ280 Sofa EJ280 Elements</p>
 <p data-bbox="108 1039 539 1088">Smoked oak stained Oak lacquered Oak soap</p>		<p data-bbox="1291 909 1453 981">EJ220 Sofa EJ280 Sofa EJ280 Elements</p>

Model 1522

EJ315 Sofa 153 cm, 2 seater



Designed by Erik Ole Jørgensen, 1975

Fully upholstered sofa with separate seat, back and arm cushions. Inner frame of wood. Available in fabric or leather. Covers are non-removable. Solid foam cushions. Arm cushions with Velcro fixing. Solid wood base.

Modeldetails

1,25 m³ Packaging dimensions:
55 kg / 45 kg L: 98 cm W: 82 cm H: 155 cm

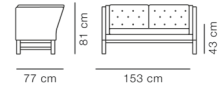

Essential Assortment

Pre-configured

Item number	Upholstery	Legs	Price
15220020700003010300	Hallingdal 200	Oak soap treated	5.950
15220026800003010300	Hallingdal 116	Oak soap treated	5.950
15225130100003016400	Leather Omni 301, Black	Walnut oil treated	8.140
15225009500003010700	Leather Max 95, Cognac	Oak light oil	9.680

Essential variants only delivered with HR foam

Order configuration

	Oak soap	Oak oiled	Oak light oil	Walnut oiled
Fabric group 1	5.545	5.755	5.545	5.820
Fabric group 2	5.950	6.160	5.950	6.225
Fabric group 3	6.145	6.355	6.145	6.420
Fabric group 4	6.730	6.940	6.730	7.005
Fabric group 5	8.075	8.285	8.075	8.410
C.O.M. fabric	5.545	5.755	5.545	5.820
Leather group 1	7.860	8.070	7.860	8.140
Leather group 2	8.575	8.785	8.575	8.850
Leather group 3	9.680	9.890	9.680	9.960
Leather group 4	10.230	10.440	10.230	10.510
Leather group 5	11.765	11.975	11.765	12.085
C.O.M. leather	7.860	8.070	7.860	8.140

Fabric consumption: 6,5 m. Leather consumption: 15,5 m²

Extra charge for

Buttons in leather for furniture with fabric: +100

Certifications

EN 1022:2023, EN 16139:2025 (L2)

Recommended upholstery

Fabric group 1	Gran Linen, Capture, Bardal, Re-wool, Linara, Natural Linen, Erik, Remix
Fabric group 2	Hallingdal, Barnum, Loop, Fiord, Steelcut Trio, Ruskin, Savoy
Fabric group 3	Divina Melange, Sunniva, Vidar
Fabric group 4	Cotil, Sisu, Safire, Elle
Fabric group 5	Gentle
Leather group 1	Omni
Leather group 2	Primo, Trace
Leather group 3	Max
Leather group 4	Nubuck, Vegeta, Organic, Cera

Model 1542

EJ315 Sofa 180 cm, 2½ seater



Designed by Erik Ole Jørgensen, 1975

Fully upholstered sofa with separate seat, back and arm cushions. Inner frame of wood. Available in fabric or leather. Covers are non-removable. Solid foam cushions. Arm cushions with Velcro fixing. Solid wood base.

Modeldetails

📦 1,47 m³ Packaging dimensions:
 📏 58 kg / 48 kg L: 98 cm W: 82 cm H: 183 cm

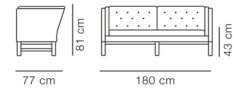

Essential Assortment

Pre-configured

Item number	Upholstery	Legs	Price
15420020700003010300	Hallingdal 200	Oak soap treated	6.810
15420026800003010300	Hallingdal 116	Oak soap treated	6.810
15425130100003016400	Leather Omni 301, Black	Walnut oil treated	9.365
15425009500003010700	Leather Max 95, Cognac	Oak light oil	11.260

Essential variants only delivered with HR foam

Order configuration

	Oak soap	Oak oiled	Oak light oil	Walnut oiled
Fabric group 1	6.325	6.535	6.325	6.605
Fabric group 2	6.810	7.020	6.810	7.085
Fabric group 3	7.040	7.255	7.040	7.320
Fabric group 4	7.740	7.950	7.740	8.015
Fabric group 5	9.285	9.500	9.285	9.620
C.O.M. fabric	6.325	6.535	6.325	6.605
Leather group 1	9.090	9.300	9.090	9.365
Leather group 2	9.940	10.150	9.940	10.215
Leather group 3	11.260	11.470	11.260	11.535
Leather group 4	11.915	12.125	11.915	12.190
Leather group 5	13.700	13.910	13.700	14.020
C.O.M. leather	9.090	9.300	9.090	9.365

Fabric consumption: 7,8 m. Leather consumption: 18,5 m²

Extra charge for

Buttons in leather for furniture with fabric: +100

Certifications

EN 1022:2023, EN 16139:2025 (L2)

Recommended upholstery

Fabric group 1	Gran Linen, Remix, Capture, Bardal, Re-wool, Linara, Natural Linen, Erik
Fabric group 2	Hallingdal, Steelcut Trio, Fiord, Ruskin, Barnum, Loop, Savoy
Fabric group 3	Vidar, Sunniva, Divina Melange
Fabric group 4	Sisu, Cotil, Elle, Safire
Fabric group 5	Gentle
Leather group 1	Omni
Leather group 2	Primo, Trace
Leather group 3	Max
Leather group 4	Nubuck, Vegeta, Organic, Cera

Model 1523

EJ315 Sofa 210 cm, 3 seater



Designed by Erik Ole Jørgensen, 1975

Fully upholstered sofa with separate seat, back and arm cushions. Inner frame of wood. Available in fabric or leather. Covers are non-removable. Solid foam cushions. Arm cushions with Velcro fixing. Solid wood base.

Modeldetails

1,7 m³

Packaging dimensions:

72 kg /
62 kg

L: 98 cm W: 82 cm H: 212 cm

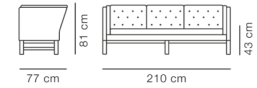

Essential Assortment

Pre-configured

Item number	Upholstery	Legs	Price
15230020700003010300	Hallingdal 200	Oak soap treated	7.345
15230026800003010300	Hallingdal 116	Oak soap treated	7.345
15235130100003016400	Leather Omni 301, Black	Walnut oil treated	10.120
15235009500003010700	Leather Max 95, Cognac	Oak light oil	12.225

Essential variants only delivered with HR foam

Order configuration

	Oak soap	Oak oiled	Oak light oil	Walnut oiled
Fabric group 1	6.815	7.025	6.815	7.090
Fabric group 2	7.345	7.555	7.345	7.620
Fabric group 3	7.600	7.810	7.600	7.875
Fabric group 4	8.360	8.575	8.360	8.640
Fabric group 5	10.035	10.245	10.035	10.370
C.O.M. fabric	6.815	7.025	6.815	7.090
Leather group 1	9.840	10.055	9.840	10.120
Leather group 2	10.775	10.985	10.775	11.050
Leather group 3	12.225	12.435	12.225	12.500
Leather group 4	12.940	13.150	12.940	13.220
Leather group 5	14.885	15.095	14.885	15.200
C.O.M. leather	9.840	10.055	9.840	10.120

Fabric consumption: 8,5 m. Leather consumption: 19,9 m²

Extra charge for

Buttons in leather for furniture with fabric: +100

Certifications

EN 1022:2023, EN 16139:2025 (L2)

Recommended upholstery

Fabric group 1	Gran Linen, Remix, Capture, Bardal, Re-wool, Linara, Natural Linen, Erik
Fabric group 2	Hallingdal, Steelcut Trio, Fiord, Ruskin, Barnum, Loop, Savoy
Fabric group 3	Vidar, Sunniva, Divina Melange
Fabric group 4	Sisu, Cotil, Elle, Safire
Fabric group 5	Gentle
Leather group 1	Omni
Leather group 2	Primo, Trace
Leather group 3	Max
Leather group 4	Nubuck, Vegeta, Organic, Cera

Model 5722

Gomo Sofa 150 cm, 2 seater



Designed by Hugo Passos, 2023

Fully upholstered sofa. Inner construction consists of a wooden shell in moulded plywood and furniture board and seat supported with webbing. Upholstered in HR or CMHR foam and cover in fabric or leather. Fabric cover is removable. Fixed base where chair is mounted with plastic legs with reversible glides in plastic which can be changed to felt.

Modeldetails

0,88 m³ Packaging dimensions:
44 kg / 30 kg L: 151 cm W: 76 cm H: 77 cm

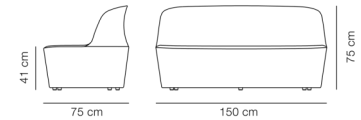

Essential Assortment

Pre-configured

Item number	Upholstery	Price
5722193000005503271	Re-Wool 198	2.855
57221931100005503271	Re-Wool 128	2.855

Essential variants are delivered with plastic glides and HR foam

Order configuration

Fabric group 0	2.540
Fabric group 1	2.855
Fabric group 2	3.085
Fabric group 3	3.305
Fabric group 4	3.700
Fabric group 5	4.425
C.O.M. fabric	2.855
Leather group 0	3.950
Leather group 1	4.510
Leather group 2	5.045
Leather group 3	5.735
Leather group 4	6.895
Leather group 5	8.910
C.O.M. leather	4.510
Sheepskin	5.745

Fabric consumption: 3,6 m. Leather consumption: 10,9 m²

When upholstered in velvet the stitching will not be visible.

Certifications

FSC® certified

EU Ecolabel variants: HR foam and upholstery in Connect, Remix, Re-wool, Steelcut Quartet, Vidar, Tonus fabric

ANSI/BIFMA X5.4-2020

Recommended upholstery

Fabric group 0	Connect
Fabric group 1	Gran Linen, Capture, Re-wool, Bardal, Linara, Remix, Erik
Fabric group 2	Barnum, Steelcut Trio, Ruskin, Fiord, Hallingdal, Loop
Fabric group 3	Sunniva, Divina Melange, Vidar, Clay, Tonus, Zero
Fabric group 4	Safire, Sisu, Elle
Fabric group 5	Gentle
Leather group 0	Vice
Leather group 1	Omni
Leather group 2	Trace, Primo
Leather group 3	Max
Leather group 4	Vegeta, Nubuck, Organic

Model P5722

Gomo Accessories Cover for Gomo sofa

Designed by Hugo Passos, 2023

Loose textile cover for re-upholstery of Gomo Sofa. Please note there will not be visible stitching in velour textiles.
Professional assistance is recommended.

Order configuration

Fabric group 0	760
Fabric group 1	855
Fabric group 2	925
Fabric group 3	985
Fabric group 4	1.110
Fabric group 5	1.325
C.O.M. fabric	855

Fabric consumption: 3,6 m

Recommended upholstery

Fabric group 0	Connect
Fabric group 1	Gran Linen, Erik, Linara, Capture, Bardal, Remix, Re-wool
Fabric group 2	Fiord, Steelcut Trio, Hallingdal, Ruskin, Barnum, Loop
Fabric group 3	Vidar, Clay, Sunniva, Divina Melange, Tonus, Zero
Fabric group 4	Sisu, Safire, Elle
Fabric group 5	Gentle

Model 2712

Jota sofa 185 cm, 2 seater



Designed by Jasper Morrison, 2024

Fully upholstered sofa with internal frame of wood and seat supported with supportive webbing. Available with cover in fabric where arm, seat and back cushions are removable covers while cover on frame is fixed. Cushions are with down and foam granulate mix in separate chambers, in addition seat cushion is made with a foam core. Cover is done with piping on gables and french stitching details on cushions. Mounted with oak legs with felt glides.

Modeldetails

1,54 m³ Packaging dimensions:
76 kg / 66 kg L: 99 cm W: 82 cm H: 190 cm

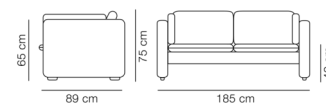

Essential Assortment

Pre-configured

Item number	Upholstery	Legs	Cushion	Price
27124705524000050206	Vidar 323	Oak light oil, FSC Mix 70%	Arm cushions not included	5.105
27124605524000050206	Vidar 323	Oak light oil, FSC Mix 70%	Arm cushions included	5.900

Essential variants only delivered with HR foam

Order configuration

Legs: wooden legs in either Oak light oil, Oak lacquered or oak black lacquered.

	Excl. arm cushions	Incl. arm cushions
Fabric group 1	4.220	4.800
Fabric group 2	4.670	5.360
Fabric group 3	5.105	5.900
Fabric group 4	5.755	6.710
Fabric group 5	7.315	8.650
C.O.M. fabric	4.220	4.800

Fabric consumption inkl. arm cushions: 10 m

Fabric consumption excl. arm cushions: 8,7 m

Certifications

FSC® certified

EN 1022:2005, EN 16139:2013 (L2)

Recommended upholstery

Fabric group 1	Bardal, Capture, Re-wool
Fabric group 2	Barnum, Steelcut Trio, Fiord, Ruskin, Loop, Hallingdal
Fabric group 3	Vidar, Clay, Divina Melange
Fabric group 4	Sisu, Elle, Safire

Model 2713

Jota sofa 231 cm, 3 seater



Designed by Jasper Morrison, 2024

Fully upholstered sofa with internal frame of wood and seat supported with supportive webbing. Available with cover in fabric where arm, seat and back cushions are removable covers while cover on frame is fixed. Cushions are with down and foam granulate mix in separate chambers, in addition seat cushion is made with a foam core. Cover is done with piping on gables and french stitching details on cushions. Mounted with oak legs with felt glides.

Modeldetails

1,93 m³ Packaging dimensions:
89 kg / L: 99 cm W: 82 cm H: 237 cm
79 kg

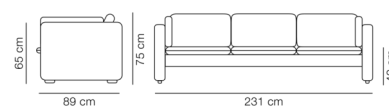

Essential Assortment

Pre-configured

Item number	Upholstery	Legs	Cushion	Price
27134705572000050206	Vidar 146	Oak light oil, FSC Mix 70%	Arm cushions not included	5.525
27134605572000050206	Vidar 146	Oak light oil, FSC Mix 70%	Arm cushions included	6.575

Essential variants only delivered with HR foam

Order configuration

Legs: wooden legs in either Oak light oil, Oak lacquered or oak black lacquered.

	Excl. arm cushions	Incl. arm cushions
Fabric group 1	4.705	5.345
Fabric group 2	5.120	5.975
Fabric group 3	5.525	6.575
Fabric group 4	6.130	7.480
Fabric group 5	7.580	9.655
C.O.M. fabric	4.705	5.345

Fabric consumption inkl. arm cushions: 12 m

Fabric consumption excl. arm cushions: 10,5 m

Certifications

FSC® certified

EN 1022:2005, EN 16139:2013 (L2)

Recommended upholstery

Fabric group 1	Bardal, Capture, Re-wool
Fabric group 2	Barnum, Steelcut Trio, Fiord, Ruskin, Loop, Hallingdal
Fabric group 3	Vidar, Clay, Divina Melange
Fabric group 4	Sisu, Elle, Safire

Model 2722

Jota sofa On legs - 185 cm, 2 seater



Designed by Jasper Morrison, 2025

Fully upholstered lounge chair with internal frame of wood and seat supported with supportive webbing. Available with cover in fabric where seat and back cushions are removable covers while cover on frame is fixed. Cushions are with down and foam granulate mix in separate chambers, in addition seat cushion is made with a foam core. Cover is done with piping on gables and french stitching details on cushions. Mounted with oak legs with felt glides.

Modeldetails

1,54 m³ Packaging dimensions:
74 kg / L: 99 cm W: 82 cm H: 190 cm
64 kg

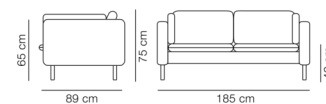

Essential Assortment

Pre-configured

Item number	Upholstery	Legs	Cushion	Price
27224708112000050206	Mood 1104	Oak light oil, FSC Mix 70%	Arm cushions not included	4.220
27224708125000050206	Mood 4104	Oak light oil, FSC Mix 70%	Arm cushions not included	4.220
27224608112000050206	Mood 1104	Oak light oil, FSC Mix 70%	Arm cushions included	4.800
27224608125000050206	Mood 4104	Oak light oil, FSC Mix 70%	Arm cushions included	4.800

Essential variants only delivered with HR foam

Order configuration

Legs: wooden legs in either Oak light oil, Oak lacquered or oak black lacquered.

	Excl. arm cushions	Incl. arm cushions
Fabric group 1	4.220	4.800
Fabric group 2	4.670	5.360
Fabric group 3	5.105	5.900
Fabric group 4	5.755	6.710
Fabric group 5	7.315	8.650
C.O.M. fabric	4.220	4.800

Fabric consumption inkl. arm cushions: 9,5 m

Fabric consumption excl. arm cushions: 8,2 m

Certifications

FSC® certified

Recommended upholstery

Fabric group 1	Bardal, Capture, Re-wool
Fabric group 2	Barnum, Steelcut Trio, Fiord, Hallingdal, Ruskin, Loop
Fabric group 3	Vidar, Clay, Divina Melange
Fabric group 4	Sisu, Elle, Safire

Model 2723

Jota sofa On legs - 231 cm, 3 seater



Designed by Jasper Morrison, 2025

Fully upholstered lounge chair with internal frame of wood and seat supported with supportive webbing. Available with cover in fabric where seat and back cushions are removable covers while cover on frame is fixed. Cushions are with down and foam granulate mix in separate chambers, in addition seat cushion is made with a foam core. Cover is done with piping on gables and french stitching details on cushions. Mounted with oak legs with felt glides.

Modeldetails

1,93 m³ Packaging dimensions:
87 kg / 77 kg L: 99 cm W: 82 cm H: 237 cm

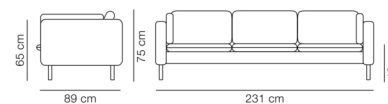

Essential Assortment

Pre-configured

Item number	Upholstery	Legs	Cushion	Price
27234704363000050224	Technicolour 370	Oak black lacquer FSC Mix 70%	Arm cushions not included	4.705
27234708125000050206	Mood 4104	Oak light oil, FSC Mix 70%	Arm cushions not included	4.705
27234700049000050206	Twillwool 1001	Oak light oil, FSC Mix 70%	Arm cushions not included	5.120
27234604363000050224	Technicolour 370	Oak black lacquer FSC Mix 70%	Arm cushions included	5.345
27234608125000050206	Mood 4104	Oak light oil, FSC Mix 70%	Arm cushions included	5.345
27234600049000050206	Twillwool 1001	Oak light oil, FSC Mix 70%	Arm cushions included	5.975

Essential variants only delivered with HR foam

Order configuration

Legs: wooden legs in either Oak light oil, Oak lacquered or oak black lacquered.

	Excl. arm cushions	Incl. arm cushions
Fabric group 1	4.705	5.345
Fabric group 2	5.120	5.975
Fabric group 3	5.525	6.575
Fabric group 4	6.130	7.480
Fabric group 5	7.580	9.655
C.O.M. fabric	4.705	5.345

Fabric consumption inkl. arm cushions: 11 m

Fabric consumption excl. arm cushions: 9,7 m

Certifications

FSC® certified

Recommended upholstery

Fabric group 1	Bardal, Capture, Re-wool
Fabric group 2	Barnum, Steelcut Trio, Fiord, Hallingdal, Ruskin, Loop
Fabric group 3	Vidar, Clay, Divina Melange
Fabric group 4	Sisu, Elle, Safire

Model P2711

Jota Accessories Decorative cushion

Modeldetails



Designed by Jasper Morrison, 2024

Decorative cushion with french stitching details for Jota. Down and foam granulate mix filling. Removable cover in fabric.

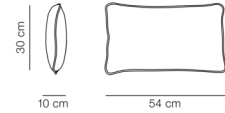

Essential Assortment

Pre-configured

Item number	Upholstery	Price
P271100055240	Vidar 323	175
P271100055340	Vidar 693	175
P271100055720	Vidar 146	175

Essential variants only delivered with HR foam

Order configuration

Fabric group 1	130
Fabric group 2	155
Fabric group 3	175
Fabric group 4	210
Fabric group 5	295
C.O.M. fabric	130

Fabric consumption: 0,65 m

Recommended upholstery

Fabric group 1	Bardal, Capture, Re-wool
Fabric group 2	Barnum, Steelcut Trio, Fiord, Ruskin, Loop, Hallingdal
Fabric group 3	Vidar, Clay, Divina Melange
Fabric group 4	Sisu, Elle, Safire

Model 4952

Konami Sofa 188 cm, 2 seater



Designed by Damian Williamson, 2019

Fully upholstered sofa. Inner frame of wood with cold cured foam. Cushions are fixed to the body of the sofa and all covers are non-removable. Available in a limited selection of fabrics only. Powder coated steel or brushed stainless steel base.

Modeldetails

2,6 m³ Packaging dimensions:
165 kg / 72 kg L: 245 cm W: 112 cm H: 95 cm

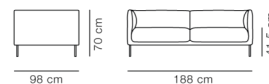

Essential Assortment

Pre-configured

Item number	Upholstery	Legs	Price
49520167014098400000	Loop 36	Black	7.295
49520167214098601000	Loop 32	Stainless steel, brushed	7.295
49520167314098400000	Loop 42	Black	7.295
49524070714098400000	Sisu 0105	Black	8.465
49524070814098601000	Sisu 0125	Stainless steel, brushed	8.465

Essential variants only delivered with HR foam

Order configuration

	Black	Brushed stainless steel
Fabric group 1	6.690	6.690
Fabric group 2	7.295	7.295
Fabric group 3	7.590	7.590
Fabric group 4	8.465	8.465
Fabric group 5	10.155	10.155
C.O.M. fabric	6.690	6.690

Fabric consumption: 7,5 m

Note - Complementary cushions are ordered separately (P4900).

Certifications

EN 1022:2005, EN 16139:2013 (L2)

Recommended upholstery

Fabric group 1	Bardal, Re-wool
Fabric group 2	Barnum, Hallingdal, Loop
Fabric group 3	Vidar, Clay, Divina Melange
Fabric group 4	Sisu, Elle, Safire
Fabric group 5	Gentle

Model 4962

Konami Sofa 235 cm, 2½ seater



Designed by Damian Williamson, 2019

Fully upholstered sofa. Inner frame of wood with cold cured foam. Cushions are fixed to the body of the sofa and all covers are non-removable. Available in a limited selection of fabrics only. Powder coated steel or brushed stainless steel base.

Modeldetails

2,6 m³ Packaging dimensions:
183 kg / 90 kg L: 245 cm W: 112 cm H: 95 cm

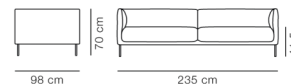

Essential Assortment

Pre-configured

Item number	Upholstery	Legs	Price
49620167014098400000	Loop 36	Black	8.120
49620167214098601000	Loop 32	Stainless steel, brushed	8.120
49620167314098400000	Loop 42	Black	8.120
49624070714098400000	Sisu 0105	Black	9.440
49624070814098601000	Sisu 0125	Stainless steel, brushed	9.440

Essential variants only delivered with HR foam

Order configuration

	Black	Brushed stainless steel
Fabric group 1	7.430	7.430
Fabric group 2	8.120	8.120
Fabric group 3	8.450	8.450
Fabric group 4	9.440	9.440
Fabric group 5	11.330	11.330
C.O.M. fabric	7.430	7.430

Fabric consumption: 7,5 m

Note - Complementary cushions are ordered separately (P4900).

Certifications

EN 1022:2005, EN 16139:2013 (L2)

Recommended upholstery

Fabric group 1	Bardal, Re-wool
Fabric group 2	Barnum, Loop, Hallingdal
Fabric group 3	Vidar, Clay, Divina Melange
Fabric group 4	Sisu, Elle, Safire
Fabric group 5	Gentle

Model 4953

Konami Sofa 277 cm, 3 seater



Designed by Damian Williamson, 2019

Fully upholstered sofa. Inner frame of wood with cold cured foam. Cushions are fixed to the body of the sofa and all covers are non-removable. Available in a limited selection of fabrics only. Powder coated steel or brushed stainless steel base.

Modeldetails

3,2 m³ Packaging dimensions:
239 kg / 110 kg L: 292 cm W: 116 cm H: 95 cm

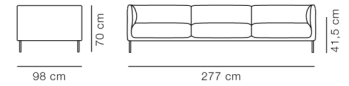

Essential Assortment

Pre-configured

Item number	Upholstery	Legs	Price
49530167014098400000	Loop 36	Black	9.495
49530167214098601000	Loop 32	Stainless steel, brushed	9.495
49530167314098400000	Loop 42	Black	9.495
49534070714098400000	Sisu 0105	Black	10.970
49534070814098601000	Sisu 0125	Stainless steel, brushed	10.970

Essential variants only delivered with HR foam

Order configuration

	Black	Brushedstainless steel
Fabric group 1	8.725	8.725
Fabric group 2	9.495	9.495
Fabric group 3	9.860	9.860
Fabric group 4	10.970	10.970
Fabric group 5	13.165	13.165
C.O.M. fabric	8.725	8.725

Fabric consumption: 9,5 m

Note - Complementary cushions are ordered separately (P4900).

Certifications

EN 1022:2005, EN 16139:2013 (L2)

Recommended upholstery

Fabric group 1	Bardal, Re-wool
Fabric group 2	Barnum, Loop, Hallingdal
Fabric group 3	Vidar, Clay, Divina Melange
Fabric group 4	Sisu, Elle, Safire
Fabric group 5	Gentle

Model P4900

Konami / Nami Accessories Decorative cushion



Designed by Damian Williamson, 2019

Decorative cushion for Konami og Nami Sofa. Down and foam granulate filling.
Removable cover in fabric.

Order configuration

Fabric group 1	325
Fabric group 2	365
Fabric group 3	395
Fabric group 4	440
Fabric group 5	550
C.O.M. fabric	325

Fabric consumption: 0,55 m

Cushion: 50 x 50 cm.

Recommended upholstery

Fabric group 1	Bardal, Re-wool, Capture, Natural Linen
Fabric group 2	Barnum, Hallingdal, Loop, Steelcut Trio, Fiord, Ruskin
Fabric group 3	Vidar, Clay, Divina Melange, Zero
Fabric group 4	Sisu, Elle, Safire
Fabric group 5	Gentle

Model 2208

Mogensen 2208 Sofa 128 cm, 2 seater



Designed by Børge Mogensen, 1963

Fully upholstered sofa with piping in all stitches. Available in leather or fabric. Fixed legs of solid wood, built into the wood internal frame. Seat is supported with jute and rubber band webbing. Cover on frame is non-removable. Separate seat and back cushions with removable covers. Please specify cushion type. Cushions are either with foam core with down wrap or filled with a foam and down mix in separate chambers.

Modeldetails

1,92 m³ Packaging dimensions:
103 kg / 37 kg L: 192 cm W: 97 cm H: 103 cm

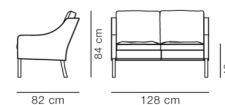

Order configuration

	Oak soap	Oak oiled	Oak light oil	Oak black lacquered	Walnut oiled
Fabric group 1	6.700	6.700	6.700	6.700	6.700
Fabric group 2	7.140	7.140	7.140	7.140	7.140
Fabric group 3	7.560	7.560	7.560	7.560	7.560
Fabric group 4	8.195	8.195	8.195	8.195	8.195
Fabric group 5	9.675	9.675	9.675	9.675	9.675
Leather group 2	8.690	8.690	8.690	8.690	8.690
Leather group 3	9.705	9.705	9.705	9.705	9.705
Leather group 4	11.090	11.090	11.090	11.090	11.090
Leather group 5	12.965	12.965	12.965	12.965	12.965

Fabric consumption: 7,65 m. Leather consumption: 12,77 m²

Certifications

EN 1022:2005, EN 16139:2013 (L2)

Recommended upholstery

Fabric group 1	Bardal, Capture, Re-wool, Linara, Erik
Fabric group 2	Hallingdal, Fiord, Ruskin, Steelcut Trio, Savoy, Loop, Barnum
Fabric group 3	Divina Melange, Vidar, Sunniva, Clay
Fabric group 4	Sisu, Safire
Fabric group 5	Gentle
Leather group 2	Primo, Trace
Leather group 3	Max
Leather group 4	Vegeta, Nubuck, Organic, Cera

Model 2209

Mogensen 2209 Sofa 186 cm, 3 seater



Designed by Børge Mogensen, 1963

Fully upholstered sofa with piping in all stitches. Available in leather or fabric. Fixed legs of solid wood, built into the wood internal frame. Seat is supported with jute and rubber band webbing. Cover on frame is non-removable. Separate seat and back cushions with removable covers. Please specify cushion type. Cushions are either with foam core with down wrap or filled with a foam and down mix in separate chambers.

Modeldetails

2,4 m³ Packaging dimensions:
129 kg / 45 kg L: 245 cm W: 97 cm H: 103 cm

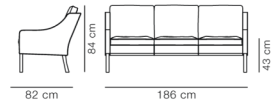

Essential Assortment

Pre-configured

Item number	Upholstery	Wood	Price
22091645009810	Leather Max 98, Black	Walnut oiled	12.615

Essential variants only delivered with HR foam

Order configuration

	Oak soap	Oak oiled	Oak light oil	Oak black lacquered	Walnut oiled
Fabric group 1	8.805	8.805	8.805	8.805	8.805
Fabric group 2	9.395	9.395	9.395	9.395	9.395
Fabric group 3	9.965	9.965	9.965	9.965	9.965
Fabric group 4	10.810	10.810	10.810	10.810	10.810
Fabric group 5	12.805	12.805	12.805	12.805	12.805
Leather group 2	11.285	11.285	11.285	11.285	11.285
Leather group 3	12.615	12.615	12.615	12.615	12.615
Leather group 4	14.310	14.310	14.310	14.310	14.310
Leather group 5	17.015	17.015	17.015	17.015	17.015

Fabric consumption: 10 m. Leather consumption: 16,26 m²

Certifications

EN 1022:2005, EN 16139:2013 (L2)

Recommended upholstery



Fabric group 1	Bardal, Linara, Capture, Re-wool, Erik
Fabric group 2	Hallingdal, Fiord, Ruskin, Savoy, Barnum, Steelcut Trio, Loop
Fabric group 3	Divina Melange, Vidar, Clay, Sunniva
Fabric group 4	Sisu, Safire
Fabric group 5	Gentle
Leather group 2	Primo, Trace
Leather group 3	Max
Leather group 4	Vegeta, Nubuck, Organic, Cera

Model 2212

Mogensen 2212 Sofa

158 cm, 2 seater

Modeldetails

 1,92 m³ Packaging dimensions:
 119 kg / 53 kg L: 192 cm W: 97 cm H: 103 cm



Designed by Børge Mogensen, 1962

Fully upholstered sofa with piping in all stitches. Available in leather or fabric. Fixed legs of solid wood, built into the wood internal frame. Seat is supported with jute and rubber band webbing. Cover on frame is non-removable. Separate seat, back and arm cushions with removable covers. Please specify cushion type. Cushions are either with foam core with down wrap or filled with a foam and down mix in separate chambers.

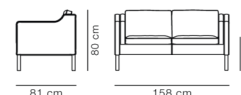

Essential Assortment

Pre-configured

Item number	Upholstery	Wood	Price
22121035009010	Leather Vegeta 90, Natural	Oak soap	12.795
22121075084110	Leather Cera 905, Russet brown	Oak light oil	12.795

Essential variants only delivered with HR foam

Order configuration

	Oak soap	Oak oiled	Oak light oil	Oak black lacquered	Walnut oiled
Fabric group 1	7.940	7.940	7.940	7.940	7.940
Fabric group 2	8.490	8.490	8.490	8.490	8.490
Fabric group 3	9.020	9.020	9.020	9.020	9.020
Fabric group 4	9.810	9.810	9.810	9.810	9.810
Fabric group 5	11.670	11.670	11.670	11.670	11.670
Leather group 2	10.075	10.075	10.075	10.075	10.075
Leather group 3	11.230	11.230	11.230	11.230	11.230
Leather group 4	12.795	12.795	12.795	12.795	12.795
Leather group 5	15.515	15.515	15.515	15.515	15.515

Fabric consumption: 11,5 m. Leather consumption: 17,42 m²

Certifications

EN 1022:2005, EN 16139:2013 (L2)

Recommended upholstery

Fabric group 1	Bardal, Linara, Capture, Re-wool, Erik
Fabric group 2	Fiord, Ruskin, Savoy, Steelcut Trio, Hallingdal, Barnum, Loop
Fabric group 3	Vidar, Clay, Sunniva, Divina Melange
Fabric group 4	Sisu, Safire
Fabric group 5	Gentle
Leather group 2	Primo, Trace
Leather group 3	Max
Leather group 4	Vegeta, Nubuck, Organic, Cera

Model 2213

Mogensen 2213 Sofa

221 cm, 3 seater



Designed by Børge Mogensen, 1962

Fully upholstered sofa with piping in all stitches. Available in leather or fabric. Fixed legs of solid wood, built into the wood internal frame. Seat is supported with jute and rubber band webbing. Cover on frame is non-removable. Separate seat, back and arm cushions with removable covers. Please specify cushion type. Cushions are either with foam core with down wrap or filled with a foam and down mix in separate chambers.

Modeldetails

2,4 m³ Packaging dimensions:
155 kg / 73 kg L: 245 cm W: 97 cm H: 103 cm

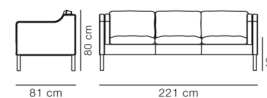

Essential Assortment

Pre-configured

Item number	Upholstery	Wood	Price
22131035009010	Leather Vegeta 90, Natural	Oak soap	16.855
22131075084110	Leather Cera 905, Russet brown	Oak light oil	16.855

Essential variants only delivered with HR foam

Order configuration

	Oak soap	Oak oiled	Oak light oil	Oak black lacquered	Walnut oiled
Fabric group 1	9.790	9.790	9.790	9.790	9.790
Fabric group 2	10.515	10.515	10.515	10.515	10.515
Fabric group 3	11.215	11.215	11.215	11.215	11.215
Fabric group 4	12.260	12.260	12.260	12.260	12.260
Fabric group 5	14.730	14.730	14.730	14.730	14.730
Leather group 2	12.995	12.995	12.995	12.995	12.995
Leather group 3	14.675	14.675	14.675	14.675	14.675
Leather group 4	16.855	16.855	16.855	16.855	16.855
Leather group 5	20.400	20.400	20.400	20.400	20.400

Fabric consumption: 12,5 m. Leather consumption: 20,9 m²

Certifications

EN 1022:2005, EN 16139:2013 (L2)

Recommended upholstery

Fabric group 1	Capture, Re-wool, Linara, Erik, Bardal
Fabric group 2	Savoy, Ruskin, Steelcut Trio, Fiord, Hallingdal, Barnum, Loop
Fabric group 3	Clay, Divina Melange, Vidar, Sunniva
Fabric group 4	Safire, Sisu
Fabric group 5	Gentle
Leather group 2	Primo, Trace
Leather group 3	Max
Leather group 4	Vegeta, Nubuck, Organic, Cera

Model 2292

Mogensen Coupé Sofa 154 cm, 2 seater



Designed by Børge Mogensen, 1971

Fully upholstered sofa with piping in all stitches. Available in leather or fabric. Fixed legs of solid wood, built into the wood internal frame. Seat is supported with jute and rubber band webbing. Cover on frame is non-removable. Separate seat, back and arm cushions with removable covers. Please specify cushion type. Cushions are either with foam core with down wrap or filled with a foam and down mix in separate chambers.

Modeldetails

1,95 m³ Packaging dimensions:
143 kg / 65 kg L: 165 cm W: 96 cm H: 124 cm

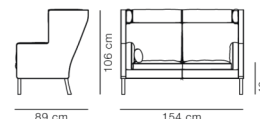

Essential Assortment

Pre-configured

Item number	Upholstery	Wood	Price
2292103500901001	Leather Vegeta 90, Natural	Oak soap	19.130
2292107508411001	Leather Cera 905, Russet brown	Oak light oil	19.130

Essential variants only delivered with HR foam

Order configuration

	Oak soap	Oak oiled	Oak light oil	Oak black lacquered	Walnut oiled
Fabric group 1	9.530	9.530	9.530	9.530	9.530
Fabric group 2	10.405	10.405	10.405	10.405	10.405
Fabric group 3	11.250	11.250	11.250	11.250	11.250
Fabric group 4	12.510	12.510	12.510	12.510	12.510
Fabric group 5	15.545	15.545	15.545	15.545	15.545
Leather group 2	14.125	14.125	14.125	14.125	14.125
Leather group 3	16.370	16.370	16.370	16.370	16.370
Leather group 4	19.130	19.130	19.130	19.130	19.130
Leather group 5	22.475	22.475	22.475	22.475	22.475

Fabric consumption: 14,1 m. Leather consumption: 26,13 m²

Incl. 1 cushion.

Recommended upholstery

Fabric group 1	Linara, Erik, Capture, Bardal, Re-wool
Fabric group 2	Ruskin, Savoy, Steelcut Trio, Hallingdal, Barnum, Loop, Fiord
Fabric group 3	Clay, Divina Melange, Vidar, Sunniva
Fabric group 4	Sisu, Safire
Fabric group 5	Gentle
Leather group 2	Primo, Trace
Leather group 3	Max
Leather group 4	Vegeta, Nubuck, Organic, Cera

Model 2202

Mogensen Ottoman 58x58 cm



Designed by Børge Mogensen, 1963

Fully upholstered ottoman with piping in all stitches. Available in leather or fabric. Fixed legs of solid wood, built into the wood internal frame. Seat is supported with polyamide webbing. Cover on frame is non-removable. Separate seat cushion with removable cover. Please specify cushion type. Cushions are either with foam core with down wrap or filled with a foam and down mix in separate chambers.

Modeldetails

0,2 m³ Packaging dimensions:
11 kg / 9 kg L: 60 cm W: 60 cm H: 55 cm

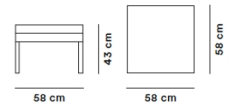

Essential Assortment

Pre-configured

Item number	Upholstery	Wood	Price
22021035009010	Leather Vegeta 90, Natural	Oak soap	2.705
22021075084110	Leather Cera 905, Russet brown	Oak light oil	2.705

Essential variants only delivered with HR foam

Order configuration

	Oak soap	Oak oiled	Oak light oil	Oak black lacquered	Walnut oiled
Fabric group 1	1.865	1.865	1.865	1.865	1.865
Fabric group 2	2.010	2.010	2.010	2.010	2.010
Fabric group 3	2.150	2.150	2.150	2.150	2.150
Fabric group 4	2.360	2.360	2.360	2.360	2.360
Fabric group 5	2.815	2.815	2.815	2.815	2.815
Leather group 2	2.220	2.220	2.220	2.220	2.220
Leather group 3	2.470	2.470	2.470	2.470	2.470
Leather group 4	2.705	2.705	2.705	2.705	2.705
Leather group 5	3.105	3.105	3.105	3.105	3.105

Fabric consumption: 2,5 m. Leather consumption: 3,13 m²

Recommended upholstery

Fabric group 1	Re-wool, Capture, Linara, Erik, Bardal
Fabric group 2	Loop, Steelcut Trio, Savoy, Barnum, Fiord, Ruskin, Hallingdal
Fabric group 3	Clay, Vidar, Divina Melange, Sunniva
Fabric group 4	Safire, Sisu
Fabric group 5	Gentle
Leather group 2	Primo, Trace
Leather group 3	Max
Leather group 4	Vegeta, Nubuck, Organic, Cera

Model 2333

Mogensen 2333 Sofa 207 cm, 3 seater



Designed by Børge Mogensen, 1971

Fully upholstered sofa, available in leather or fabric. Fixed legs of solid wood, built into the wood internal frame. Seat is supported with polyamide webbing. Cover on frame is non-removable. Separate seat, back and arm cushions with removable covers. Cushions has foam core with down wrap. Leather sofas has piping in all stitches and fabric sofas are made with double stitch.

Modeldetails

2,4 m³ Packaging dimensions:
152 kg / 68 kg L: 245 cm W: 97 cm H: 103 cm

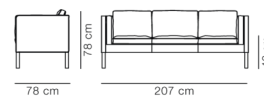

Order configuration

	Oak light oil	Oak black lacquered
Fabric group 1	7.215	7.215
Fabric group 2	7.580	7.580
Fabric group 3	8.240	8.240
Fabric group 4	8.735	8.735
Fabric group 5	10.480	10.480
C.O.M. fabric	7.215	7.215
Leather group 1	11.300	11.300
Leather group 2	12.755	12.755
Leather group 3	14.265	14.265
Leather group 4	15.690	15.690
Leather group 5	18.045	18.045
C.O.M. leather	11.300	11.300

Fabric consumption: 11 m. Leather consumption: 20,9 m²

The sofa is delivered without piping, when upholstered in fabric.

Extra charge for

Fabric or leather piping for furniture with fabric: +655
Oak lacquered, oak soap, oak oiled or stained legs: +355

Recommended upholstery

Fabric group 1 Gran Linen, Erik, Remix, Bardal, Re-wool, Linara, Capture
Fabric group 2 Hallingdal, Loop, Steelcut Trio, Fiord, Ruskin, Barnum
Fabric group 3 Divina Melange, Vidar, Sunniva, Clay
Fabric group 4 Sisu, Elle, Safire, Cotil
Fabric group 5 Gentle
Leather group 1 Omni
Leather group 2 Primo, Trace
Leather group 3 Max
Leather group 4 Nubuck, Organic, Vegeta, Cera

Model 2335

Mogensen 2335 Sofa 180 cm, 2½ seater



Designed by Børge Mogensen, 1996

Fully upholstered sofa, available in leather or fabric. Fixed legs of solid wood, built into the wood internal frame. Seat is supported with polyamide webbing. Cover on frame is non-removable. Separate seat, back and arm cushions with removable covers. Cushions has foam core with down wrap. Leather sofas has piping in all stitches, fabric sofas are made with double stitch.

Modeldetails

1,94 m³ Packaging dimensions:
126 kg / 60 kg L: 192 cm W: 97 cm H: 103 cm

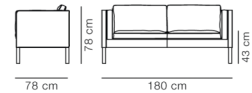

Order configuration

	Oak light oil	Oak black lacquered
Fabric group 1	6.785	6.785
Fabric group 2	7.130	7.130
Fabric group 3	7.830	7.830
Fabric group 4	8.310	8.310
Fabric group 5	9.970	9.970
C.O.M. fabric	6.785	6.785
Leather group 1	10.150	10.150
Leather group 2	11.635	11.635
Leather group 3	13.260	13.260
Leather group 4	14.585	14.585
Leather group 5	16.770	16.770
C.O.M. leather	10.150	10.150

Fabric consumption: 10,5 m. Leather consumption: 20,07 m²

Design: Børge Mogensen Studio

The sofa is delivered without piping, when upholstered in fabric.

Extra charge for

Fabric or leather piping for furniture with fabric: +550
Oak lacquered, oak soap, oak oiled or stained legs: +355

Recommended upholstery

Fabric group 1 Gran Linen, Erik, Remix, Bardal, Re-wool, Linara, Capture
Fabric group 2 Hallingdal, Loop, Steelcut Trio, Fiord, Ruskin, Barnum
Fabric group 3 Divina Melange, Vidar, Sunniva, Clay
Fabric group 4 Sisu, Elle, Safire, Cotil
Fabric group 5 Gentle
Leather group 1 Omni
Leather group 2 Primo, Trace
Leather group 3 Max
Leather group 4 Nubuck, Organic, Vegeta, Cera

Model 4901

Nami Sofa End module 100x98 cm, Arm L or R



Designed by Damian Williamson, 2023

Fully upholstered sofa module. Inner frame of wood with cold cured foam. Cushions are fixed to the body of the sofa and all covers are non-removable. Legs in black lacquered ash mounted with felt glides. Mounted with coupling device for modular configurations. Please specify right- or left.
All sofa configurations must be finished with a right or left end module.

Modeldetails

0,84 m³ Packaging dimensions:
60 kg / 52 kg L: 97 cm W: 82 cm H: 105 cm

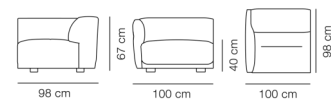

Essential Assortment

Pre-configured

Item number	Upholstery	Legs	Module type	Price
4901016700270037900	Loop 36	Blask ash	Right module	2.870
4901016700280037900	Loop 36	Blask ash	Left module	2.870
4901020390270037900	Zero 0001	Blask ash	Right module	3.125
4901020390280037900	Zero 0001	Blask ash	Left module	3.125

Essential variants only delivered with HR foam

Order configuration

Fabric group 1	2.605
Fabric group 2	2.870
Fabric group 3	3.125
Fabric group 4	3.390
Fabric group 5	4.100
C.O.M. fabric	2.605

Fabric consumption: 4 m

Certifications

EN 1022:2005, EN 16139:2013 (L2)

Recommended upholstery

Fabric group 1	Bardal, Capture, Natural Linen, Re-wool
Fabric group 2	Barnum, Steelcut Trio, Fiord, Hallingdal, Loop, Ruskin
Fabric group 3	Vidar, Clay, Divina Melange, Zero
Fabric group 4	Sisu, Elle, Safire
Fabric group 5	Gentle

Model 4902

Nami Sofa Seat module 88x98 cm



Designed by Damian Williamson, 2023

Fully upholstered sofa module. Inner frame of wood with cold cured foam. Cushions are fixed to the body of the sofa and all covers are non-removable. Legs in black lacquered ash mounted with felt glides. Mounted with coupling device for modular configurations.

All sofa configurations must be finished with a right or left end module.

Modeldetails

0,74 m³ Packaging dimensions:
48 kg / 40 kg L: 97 cm W: 82 cm H: 93 cm

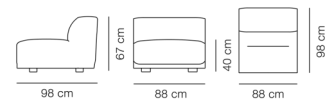

Essential Assortment

Pre-configured

Item number	Upholstery	Legs	Price
4902016700000037900	Loop 36	Blask ash	2.485
4902020390000037900	Zero 0001	Blask ash	2.715

Essential variants only delivered with HR foam

Order configuration

Fabric group 1	2.240
Fabric group 2	2.485
Fabric group 3	2.715
Fabric group 4	2.950
Fabric group 5	3.590
C.O.M. fabric	2.240

Fabric consumption: 3,5 m

Certifications

EN 1022:2005, EN 16139:2013 (L2)

Recommended upholstery

Fabric group 1	Capture, Bardal, Re-wool, Natural Linen
Fabric group 2	Fiord, Loop, Steelcut Trio, Barnum, Hallingdal, Ruskin
Fabric group 3	Vidar, Divina Melange, Clay, Zero
Fabric group 4	Sisu, Safire, Elle
Fabric group 5	Gentle

Model 4913

Nami Sofa Corner module 96x96 cm



Designed by Damian Williamson, 2023

Fully upholstered sofa module. Inner frame of wood with cold cured foam. Cushions are fixed to the body of the sofa and all covers are non-removable. Legs in black lacquered ash mounted with felt glides. Mounted with coupling device for modular configurations.

All sofa configurations must be finished with a right or left end module.

Modeldetails

0,81 m³ Packaging dimensions:
68 kg / L: 97 cm W: 82 cm H: 101 cm
60 kg

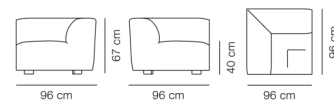

Essential Assortment

Pre-configured

Item number	Upholstery	Legs	Price
4913016700000037900	Loop 36	Blask ash	3.040
4913020390000037900	Zero 0001	Blask ash	3.300

Essential variants only delivered with HR foam

Order configuration

Fabric group 1	2.760
Fabric group 2	3.040
Fabric group 3	3.300
Fabric group 4	3.580
Fabric group 5	4.330
C.O.M. fabric	2.760

Fabric consumption: 4 m

Certifications

EN 1022:2005, EN 16139:2013 (L2)

Recommended upholstery

Fabric group 1	Capture, Bardal, Re-wool, Natural Linen
Fabric group 2	Fiord, Loop, Steelcut Trio, Barnum, Hallingdal, Ruskin
Fabric group 3	Vidar, Divina Melange, Clay, Zero
Fabric group 4	Sisu, Safire, Elle
Fabric group 5	Gentle

Model P4900

Konami / Nami Accessories Decorative cushion



Designed by Damian Williamson, 2019

Decorative cushion for Konami og Nami Sofa. Down and foam granulate filling.
Removable cover in fabric.

Order configuration

Fabric group 1	325
Fabric group 2	365
Fabric group 3	395
Fabric group 4	440
Fabric group 5	550
C.O.M. fabric	325

Fabric consumption: 0,55 m

Cushion: 50 x 50 cm.

Recommended upholstery

Fabric group 1	Bardal, Re-wool, Capture, Natural Linen
Fabric group 2	Barnum, Hallingdal, Loop, Steelcut Trio, Fiord, Ruskin
Fabric group 3	Vidar, Clay, Divina Melange, Zero
Fabric group 4	Sisu, Elle, Safire
Fabric group 5	Gentle

Model 490A

Nami Sofa Configuration A, 200 x 98cm



Designed by Damian Williamson, 2023

Fully upholstered sofa module. Inner frame of wood with cold cured foam. Cushions are fixed to the body of the sofa and all covers are non-removable. Legs in black lacquered ash mounted with felt glides. Mounted with coupling device for modular configurations.

Modeldetails

1,68 m³ Packaging dimensions:
120 kg / L: 97/97 cm W: 82/82 cm H:
104 kg 105/105 cm

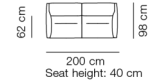

Order configuration

Fabric group 1	5,210
Fabric group 2	5,740
Fabric group 3	6,250
Fabric group 4	6,780
Fabric group 5	8,200
C.O.M. fabric	5,210

Fabric consumption: 8 m. Leather consumption: 16 m²

Configuration consist of model 4901 (left) / 4901 (right)

Certifications

EN 1022:2005, EN 16139:2013 (L2)

Recommended upholstery

Fabric group 1	Bardal, Re-wool, Capture, Natural Linen
Fabric group 2	Steelcut Trio, Loop, Fiord, Barnum, Hallingdal, Ruskin
Fabric group 3	Vidar, Divina Melange, Clay, Zero
Fabric group 4	Sisu, Safire, Elle
Fabric group 5	Gentle

Model 490B

Nami Sofa Configuration B, 288 x 98cm



Designed by Damian Williamson, 2023

Fully upholstered sofa module. Inner frame of wood with cold cured foam. Cushions are fixed to the body of the sofa and all covers are non-removable. Legs in black lacquered ash mounted with felt glides. Mounted with coupling device for modular configurations.

Modeldetails

2,42 m³ Packaging dimensions:
168 kg / L: 97/88/97 cm W: 82/82/82 cm H:
144 kg 105/93/105 cm

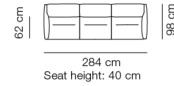

Order configuration

Fabric group 1	7.450
Fabric group 2	8.225
Fabric group 3	8.965
Fabric group 4	9.730
Fabric group 5	11.790
C.O.M. fabric	7.450

Fabric consumption: 11,5 m. Leather consumption: 24 m²

Configuration consist of model 4901 (left) / 4902 / 4901 (right)

Certifications

EN 1022:2005, EN 16139:2013 (L2)

Recommended upholstery

Fabric group 1	Bardal, Re-wool, Capture, Natural Linen
Fabric group 2	Steelcut Trio, Loop, Fiord, Barnum, Hallingdal, Ruskin
Fabric group 3	Vidar, Divina Melange, Clay, Zero
Fabric group 4	Sisu, Safire, Elle
Fabric group 5	Gentle

Model 490C

Nami Sofa Configuration C, 284 x 284cm



Designed by Damian Williamson, 2023

Fully upholstered sofa module. Inner frame of wood with cold cured foam. Cushions are fixed to the body of the sofa and all covers are non-removable. Legs in black lacquered ash mounted with felt glides. Mounted with coupling device for modular configurations.

Modeldetails

3,97 m³ Packaging dimensions:
284 kg / L: 97/97/97/97/97 cm W:
244 kg 82/82/82/82/82 cm H: 105/93/101/93

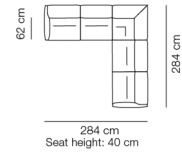

Order configuration

Fabric group 1	12.450
Fabric group 2	13.750
Fabric group 3	14.980
Fabric group 4	16.260
Fabric group 5	19.710
C.O.M. fabric	12.450

Fabric consumption: 19 m. Leather consumption: 40 m²

Configuration consist of model 4901 (left) / 4902 / 4913 / 4902 / 4901 (right)

Certifications

EN 1022:2005, EN 16139:2013 (L2)

Recommended upholstery

Fabric group 1	Bardal, Re-wool, Capture, Natural Linen
Fabric group 2	Steelcut Trio, Loop, Fiord, Barnum, Hallingdal, Ruskin
Fabric group 3	Vidar, Divina Melange, Clay, Zero
Fabric group 4	Sisu, Safire, Elle
Fabric group 5	Gentle

Model 2002

No. 1 Sofa 143 cm, 2 seater



Designed by Børge Mogensen, 1955

Fully upholstered sofa with separate seat and back cushions. Interchangeable legs of solid wood mounted with metal threads. Inner frame of solid wood and plywood. Interchangeable cushions of HR or CMHR foam covered in fabric and mounted with buttons. Covers are non-removable. Back cushions are reversible with fabric on both sides.

Modeldetails

0,9 m³ Packaging dimensions:
83 kg / 42 kg L: 92 cm W: 148 cm H: 66 cm

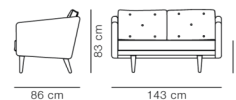

Order configuration

	Oak soap	Oak light oil / Oak oiled	Oak black lacquered / Smoked oak stained, lacquered
Fabric group 0	3.960	3.960	3.960
Fabric group 1	4.255	4.255	4.255
Fabric group 2	4.550	4.550	4.550
Fabric group 3	4.830	4.830	4.830
Fabric group 4	5.500	5.500	5.500
Fabric group 5	6.575	6.575	6.575
C.O.M. fabric	4.255	4.255	4.255

Fabric consumption: 6,3 m

Certifications

FSC® certified

Recommended upholstery

Fabric group 0	Connect
Fabric group 1	Capture, Re-wool, Linara, Bardal, Remix, Gran Linen, Erik
Fabric group 2	Savoy, Fiord, Hallingdal, Steelcut Trio, Barnum, Loop, Ruskin
Fabric group 3	Sunniva, Vidar, Clay, Divina Melange
Fabric group 4	Sisu, Safire, Elle
Fabric group 5	Gentle, Grand Mohair

Model 2003

No. 1 Sofa 206 cm, 3 seater

Modeldetails

1,2 m³ Packaging dimensions:
88 kg / 54 kg L: 92 cm W: 211 cm H: 63 cm



Designed by Børge Mogensen, 1955

Fully upholstered sofa with separate seat and back cushions. Interchangeable legs of solid wood mounted with metal threads. Inner frame of solid wood and plywood. Interchangeable cushions of HR or CMHR foam covered in fabric and mounted with buttons. Covers are non-removable. Back cushions are reversible with fabric on both sides.

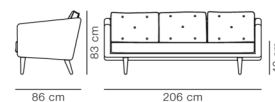

Essential Assortment

Pre-configured

Item number	Upholstery	Legs	Price
200316011000050203	Bardal 220	Oak soap treated, FSC Mix 70%	5.340
200316014000050203	Bardal 860	Oak soap treated, FSC Mix 70%	5.340
200316015000050203	Bardal 780	Oak soap treated, FSC Mix 70%	5.340
200300201000050205	Hallingdal 180	Oak oil, FSC Mix 70%	5.730
200300219000050203	Hallingdal 130	Oak soap treated, FSC Mix 70%	5.730

Essential variants only delivered with HR foam

Order configuration

	Oak soap	Oak light oil / Oak oiled	Oak black lacquered / Smoked oak stained, lacquered
Fabric group 0	4.965	4.965	4.965
Fabric group 1	5.340	5.340	5.340
Fabric group 2	5.730	5.730	5.730
Fabric group 3	6.100	6.100	6.100
Fabric group 4	6.925	6.925	6.925
Fabric group 5	8.305	8.305	8.305
C.O.M. fabric	5.340	5.340	5.340

Fabric consumption: 8,3 m

Certifications

FSC® certified

Recommended upholstery

Fabric group 0	Connect
Fabric group 1	Capture, Re-wool, Linara, Bardal, Remix, Gran Linen, Erik
Fabric group 2	Savoy, Fiord, Hallingdal, Steelcut Trio, Barnum, Loop, Ruskin
Fabric group 3	Sunniva, Vidar, Clay, Divina Melange
Fabric group 4	Sisu, Safire, Elle
Fabric group 5	Gentle, Grand Mohair

Model 8802

Savannah Sofa 182 cm, 2 seater



Designed by Monica Förster, 2015

Lounge sofa with upholstered cushions. External frame of solid wood mounted with non-removable upholstery leather, fabric or 100% linen canvas. Cushions of cold cured foam, either HR or CMHR foam, upholstered in fabric. Cover is non-removable on frame and back. Cover on seat cushion is removable.

Modeldetails

1,94 m³ Packaging dimensions:
128 kg / 62 kg L: 192 cm W: 97 cm H: 104 cm

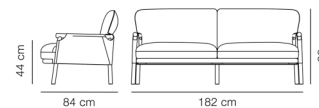

Essential Assortment

Pre-configured

Item number	Upholstery cushions/seat	Upholstery frame	Wood	Price
88025009500207020600	Hallingdal 200	Leather Max 95, Cognac	Oak light oil, FSC Mix 70%	7.500
88025090601678020600	Elle 280	Leather Organic 906, Mocca	Oak light oil, FSC Mix 70%	8.595

Essential variants only delivered with HR foam

Order configuration

Frame: Oak light oil or oak black lacquered.

	Cushions: Fabric gr. 1	Cushions: Fabric gr. 2	Cushions: Fabric gr. 3	Cushions: Fabric gr. 4	Cushions: Fabric gr. 5	Cushions: Fabric COM
Fabric group 1	6.580	7.055	7.285	7.970	9.560	6.580
Fabric group 2	6.645	7.130	7.355	8.045	9.655	6.645
Fabric group 3	6.710	7.200	7.430	8.130	9.755	6.710
Fabric group 4	6.780	7.270	7.505	8.225	9.850	6.780
Fabric group 5	6.845	7.345	7.580	8.310	9.950	6.845
C.O.M. fabric	6.580	7.055	7.285	7.970	9.560	6.580
Leather group 1	6.725	7.200	7.425	8.110	9.705	6.725
Leather group 2	6.845	7.320	7.550	8.235	9.830	6.845
Leather group 3	7.025	7.500	7.730	8.415	10.010	7.025
Leather group 4	7.210	7.680	7.910	8.595	10.190	7.210
C.O.M. leather	6.725	7.200	7.425	8.110	9.705	6.725
Canvas black or natural	6.580	7.055	7.285	7.970	9.560	6.580

Fabric consumption: 6,1 m

Fabric consumption on frame: 1,8 m.

Leather consumption on frame: 5 m²

Note - arm cushions have to be ordered separately (P8801).

Certifications

FSC® certified

EN 1022:2005, EN 16139:2013 (L2), ANSI/BIFMA X7.1/M7.1/e3-2019 VOC test (tested with HR foam and EU Ecolabel fabric)

Recommended upholstery

Fabric group 1	Bardal, Capture, Re-wool, Gran Linen, Erik
Fabric group 2	Fiord, Steelcut Trio, Barnum, Ruskin, Loop, Hallingdal
Fabric group 3	Sunniva, Clay, Vidar, Divina Melange
Fabric group 4	Sisu, Safire, Elle
Fabric group 5	Gentle
Leather group 0	Vice
Leather group 1	Omni
Leather group 2	Primo, Trace
Leather group 3	Max
Leather group 4	Vegeta, Nubuck, Organic

Model P8801

Savannah Accessories Set of 2 arm cushions



Designed by Monica Förster, 2015

Arm cushion in foam upholstered in textile. Cover on cushion is removable.

Order configuration

Fabric group 1	365
Fabric group 2	400
Fabric group 3	430
Fabric group 4	500
Fabric group 5	565
C.O.M. fabric	365

Fabric consumption: 0,5 m

Recommended upholstery

Fabric group 1	Gran Linen, Bardal, Capture, Erik, Re-wool
Fabric group 2	Barnum, Steelcut Trio, Fiord, Hallingdal, Loop, Ruskin
Fabric group 3	Vidar, Clay, Sunniva, Divina Melange
Fabric group 4	Sisu, Elle, Safire
Fabric group 5	Gentle

Model 1712



Spine Lounge Sofa 160 cm, 2 seater



Designed by Space Copenhagen, 2011

Sofa with legs of solid wood. Wooden seat shell of moulded plywood. The seat cushion in HR or CMHR foam. Available in fabric or leather, with piping in all stitches. Cushions are kept in place with Velcro fixtures and are removable for cleaning. Cover on cushion is removable.

Modeldetails

 1,14 m³ Packaging dimensions:
 65 kg / 51 kg L: 87 cm W: 168 cm H: 78 cm

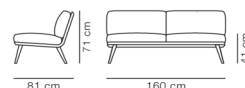

Essential Assortment

Pre-configured

Item number	Upholstery	Wood	Price
171222300050088	Leather Primo 88, Black	Black ash, FSC Mix 70%	6.680
171222300050841	Leather Cera 905, Russet brown	Black ash, FSC Mix 70%	8.140

Essential variants only delivered with HR foam

Order configuration

	Black ash	Smoked oak stained, lacquered
Fabric group 0	4.945	5.305
Fabric group 1	5.320	5.680
Fabric group 2	5.635	6.000
Fabric group 3	6.140	6.500
Fabric group 4	6.980	7.340
Fabric group 5	7.500	7.860
C.O.M. fabric	5.320	5.680
Leather group 0	5.485	5.845
Leather group 1	5.895	6.260
Leather group 2	6.680	7.040
Leather group 3	7.400	7.765
Leather group 4	8.140	8.505
Leather group 5	9.360	9.725
C.O.M. leather	5.895	6.260

Fabric consumption: 4,8 m. Leather consumption: 10 m²

QuickClick glides with felt upon request (R1730).

Certifications

FSC® certified
EN 15373:2007 (L2)

Recommended upholstery

Fabric group 1	Gran Linen, Linara, Bardal, Capture, Remix, Re-wool, Natural Linen, Erik
Fabric group 2	Savoy, Barnum, Steelcut Trio, Fiord, Hallingdal, Ruskin, Loop
Fabric group 3	Vidar, Clay, Sunniva, Divina Melange
Fabric group 4	Sisu, Safire, Cotil, Elle
Fabric group 5	Gentle, Grand Mohair
Leather group 0	Vice
Leather group 1	Omni
Leather group 2	Primo, Trace
Leather group 3	Max
Leather group 4	Nubuck, Organic, Vegeta, Cera

Model 1789

The Spoke-Back Sofa 160 cm, 2 seater



Designed by Børge Mogensen, 1945

Sofa with frame in solid wood. Seat supported by jute webbing. Interchangeable seat and back cushions in solid HR foam, covered in fabric or leather and finished with buttons. Chaise longue angle adjusted and supported with interchangeable leather straps. When covered in fabric the seat cushion is reversible. Leather seat cushion has hessian backing.

Modeldetails

1,18 m³ Packaging dimensions:
39 kg / 30 kg L: 164 cm W: 79 cm H: 91 cm

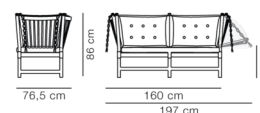

Essential Assortment

Pre-configured

Item number	Upholstery	Wood	Price
178920344806301	Natural Linen 0003	Oak soap, FSC Mix 70%	8.275
178920314108301	Capture 4201	Oak soap, FSC Mix 70%	8.275
178920314112301	Capture 5201	Oak soap, FSC Mix 70%	8.275
178920300950301	Cotil 863, 53938	Oak soap, FSC Mix 70%	9.215
178922451301301	Leather Omni 301, Black	Oak black lacquer, FSC Mix 70%	9.745
178920350095301	Leather Max 95, Cognac	Oak soap, FSC Mix 70%	11.205

Essential variants only delivered with HR foam

Order configuration

	Oak soap	Oak oiled	Oak black lacquered	Beech soap
Fabric group 1	8.275	8.275	8.275	6.795
Fabric group 2	8.550	8.550	8.550	7.075
Fabric group 3	8.815	8.815	8.815	7.340
Fabric group 4	9.215	9.215	9.215	7.740
Fabric group 5	10.175	10.175	10.175	8.700
C.O.M. fabric	8.275	8.275	8.275	6.795
Leather group 1	9.745	9.745	9.745	8.265
Leather group 2	10.275	10.275	10.275	8.800
Leather group 3	11.205	11.205	11.205	9.725
Leather group 4	12.455	12.455	12.455	10.975
Leather group 5	14.570	14.570	14.570	13.095
C.O.M. leather	9.745	9.745	9.745	8.265

Certifications

FSC® certified

EN 1022:2005, EN 16139:2013 (L1)

Recommended upholstery

Fabric group 1	Remix, Erik, Capture, Bardal, Re-wool, Linara, Natural Linen, Gran Linen
Fabric group 2	Steelcut Trio, Savoy, Hallingdal, Barnum, Fiord, Ruskin
Fabric group 3	Vidar, Sunniva, Divina Melange, Clay
Fabric group 4	Safire, Elle, Sisu, Cotil
Fabric group 5	Gentle
Leather group 1	Omni
Leather group 2	Primo, Trace
Leather group 3	Max
Leather group 4	Nubuck, Vegeta, Organic, Cera

Model P1789S

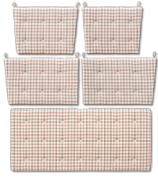

The Spoke-Back Sofa Accessories

Set of fabric cushions for 1789

Designed by Børge Mogensen

Cushions in solid HR foam, covered in fabric and finished with buttons. When covered in fabric the seat cushion is reversible.

Modeldetails

0,12 m³

12 kg /
8,05 kg

Essential Assortment

Pre-configured

Item number	Upholstery	Price
P1789S14108	Capture 4201	2.015
P1789S14112	Capture 5201	2.015
P1789S44806	Natural Linen 0003	2.015
P1789S00950	Cotil 863, 53938	2.955

Essential variants only delivered with HR foam

Order configuration

Fabric group 1	2.015
Fabric group 2	2.290
Fabric group 3	2.560
Fabric group 4	2.955
Fabric group 5	3.915
C.O.M. fabric	2.015

Fabric consumption: 4,5 m

Recommended upholstery

Fabric group 1	Linara, Bardal, Capture, Remix, Natural Linen, Re-wool, Erik, Gran Linen
Fabric group 2	Barnum, Steelcut Trio, Fiord, Hallingdal, Ruskin, Savoy
Fabric group 3	Vidar, Clay, Sunniva, Divina Melange
Fabric group 4	Sisu, Elle, Safire, Cotil
Fabric group 5	Gentle

Model P1789L



The Spoke-Back Sofa Accessories Set of leather cushions for 1789

Designed by Børge Mogensen

Cushions in solid HR foam, covered in leather and finished with buttons. Leather seat cushion has hessian backing.

Essential Assortment

Pre-configured

Item number	Upholstery	Price
P1789L51301	Leather Omni 301, Black	3.485
P1789L50095	Leather Max 95, Cognac	4.945

Essential variants only delivered with HR foam

Order configuration

Leather group 1	3.485
Leather group 2	4.015
Leather group 3	4.945
Leather group 4	6.195
Leather group 5	8.310
C.O.M. leather	3.485

Leather consumption: 10 m²

Recommended upholstery

Leather group 1	Omni
Leather group 2	Primo, Trace
Leather group 3	Max
Leather group 4	Nubuck, Vegeta, Organic, Cera

**Model
R1789**

The Spoke-Back Sofa Accessories Leather straps



Designed by Børge Mogensen

Leather straps for The Spoke-Back sofa. Leather straps for adjusting the angle of the chaise longue.

Order configuration

Leatherstraps in
natural each set

145

Tables

Model 6271

BM71 Library Table Gate leg table



Designed by Børge Mogensen, 1958

Gate-leg table with solid wood frame and veneered oak top in solid frame sections.

Modeldetails

1,03 m³ Packaging dimensions:
100 kg / 60 kg L: 136 cm W: 98 cm H: 77 cm

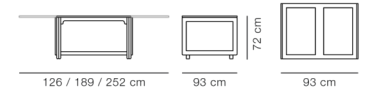

Essential Assortment

Pre-configured

Item number	Wood	Price
6271322102	Oak lacquer	6.120
6271322205	Oak oil, FSC Mix 70%	6.120

Tabletop length: 126 cm.
Extended: 189 or 252 cm.

Certifications

Oak oiled is FSC® certified

Model 6280

BM80 Mogensen Shaker Table 90 x 90 cm



Designed by Børge Mogensen, 1961

Square table with frame and table top in solid wood. Leg mounted with a visible brass screw. Knock-down, delivered unassembled.

Modeldetails

0,16 m³ Packaging dimensions:
32 kg / L: 100/84 cm W: 100/60 cm H: 6/18
23 kg cm

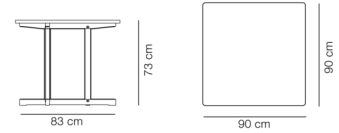

Essential Assortment

Pre-configured

Item number	Wood	Price
6280227203	Oak soap, FSC Mix 70%	2.245
6280227205	Oak oil, FSC Mix 70%	2.245
6280227206	Oak light oil, FSC Mix 70%	2.245
6280227207	Smoked oak, oiled, FSC Mix 70%	2.690

Certifications

FSC® certified
EN 15372:2016 (L3)

Model 6282

BM80 Mogensen Shaker Table Ø120 cm



Designed by Børge Mogensen, 1961

Round table with frame and table top in solid wood. Leg mounted with a visible brass screw. Knock-down, delivered unassembled.

Modeldetails

0,2 m³ Packaging dimensions:
42 kg / 27 kg L: 130/84 cm W: 130/60 cm H: 6/18 cm

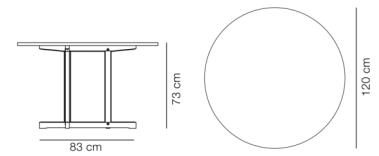

Essential Assortment

Pre-configured

Item number	Wood	Price
6282122203	Oak soap, FSC Mix 70%	2.510
6282122205	Oak oil, FSC Mix 70%	2.510
6282122206	Oak light oil, FSC Mix 70%	2.510
6282122207	Smoked oak, oiled, FSC Mix 70%	2.955

Certifications

FSC® certified
EN 15372:2016 (L3)

Model 6284

BM84 Mogensen Table 180x90 cm



Designed by Børge Mogensen, 1958

Rectangular table with frame and table top in solid wood. Leg mounted with a visible brass screw. Knock-down, delivered unassembled.

Modeldetails

0,18 m³ Packaging dimensions:
43 kg / 40 kg L: 185 cm W: 93 cm H: 10 cm

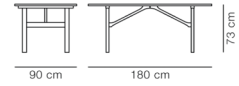

Essential Assortment

Pre-configured

Item number	Wood	Price
6284197206	Oak light oil, FSC Mix 70%	4.070

Order configuration

	Oak soap	Oak oiled	Oak light oil	Smoked oak, oiled
	4.070	4.110	4.070	4.680

Certifications

FSC® certified
EN 15372:2023 (L3)

Model 0290

C18 Accessories Additional leaf for 6290, 6293, 6284

Designed by Børge Mogensen

Additional leaf in black lacquered MDF. Brackets in beech wood and black powder coated steel.
Compatible with C18 table width 90 cm and BM84 (6284).

Modeldetails

0,04 m³ Packaging dimensions:
7 kg / 4,5 kg L: 47 cm W: 96 cm H: 16 cm

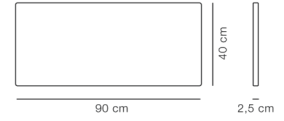

Order configuration

Black lacquered
(each)

385

Model 6286

BM86 Mogensen Shaker Table 195x97.5 cm



Designed by Børge Mogensen, 1964

Rectangular table with frame and table top in solid wood. Leg mounted with a visible brass screw. Knock-down, delivered unassembled.

Modeldetails

0,2 m³ Packaging dimensions:
62 kg / 56 kg L: 203 cm W: 104 cm H: 10 cm



Essential Assortment

Pre-configured

Item number	Wood	Price
6286193105	Oak oil	5.780

Order configuration

	Oak soap	Oak oiled	Oak light oil	Smoked oak, oiled
	5.740	5.780	5.740	6.605

Model 6386

BM86 Mogensen Shaker Table 245x97.5 cm



Designed by Børge Mogensen, 1964

Rectangular table with frame and table top in solid wood. Leg mounted with a visible brass screw. Knock-down, delivered unassembled.

Modeldetails

0,26 m³ Packaging dimensions:
72 kg / 66 kg L: 265 cm W: 100 cm H: 10 cm

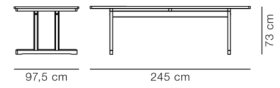

Essential Assortment

Pre-configured

Item number	Wood	Price
6386194105	Oak oil	6.940

Order configuration

	Oak soap	Oak oiled	Oak light oil	Smoked oak, oiled
	6.900	6.940	6.900	7.935

**Model
0286**

BM86 Accessories
Additional leaf for 6286 / 6386

Designed by Børge Mogensen

Additional leaf in black lacquered MDF for BM86 table. Brackets in beech wood and black powder coated steel.

Modeldetails

0,07 m³ Packaging dimensions:
7,25 kg / L: 104 cm W: 47 cm H: 16 cm
6 kg

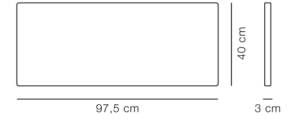

Order configuration

**Black lacquered
(each)**

385

Model 6292

C18 Mogensen Shaker Table 160x80 cm



Designed by Børge Mogensen, 1947

Rectangular table with frame and table top in solid wood. Leg mounted with a visible brass screw. Knock-down, delivered unassembled.

Modeldetails

0,14 m³ Packaging dimensions:
34 kg / 29 kg L: 165 cm W: 83 cm H: 10 cm

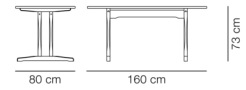

Essential Assortment

Pre-configured

Item number	Wood	Price
6292183203	Oak soap, FSC Mix 70%	3.015
6292183205	Oak oil, FSC Mix 70%	3.015
6292183206	Oak light oil, FSC Mix 70%	3.015
6292183207	Smoked oak, oiled, FSC Mix 70%	3.585

Certifications

FSC® certified

Model 0292

C18 Accessories Additional leaf for 6292

Designed by Børge Mogensen

Additional leaf in black lacquered MDF for C18 table in width 80 cm. Brackets in beech wood and black powder coated steel.

Modeldetails

0,04 m³ Packaging dimensions:
5,7 kg / 4,5 kg L: 47 cm W: 86 cm H: 16 cm

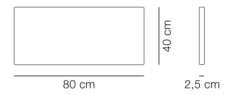

Order configuration

Black lacquered
(each)

380

Model 6290

C18 Mogensen Shaker Table 180x90 cm



Designed by Børge Mogensen, 1947

Rectangular table with frame and table top in solid wood. Leg mounted with a visible brass screw. Knock-down, delivered unassembled.

Modeldetails

0,18 m³ Packaging dimensions:
42,7 kg / 39 kg L: 185 cm W: 93 cm H: 10 cm

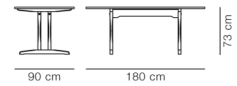

Essential Assortment

Pre-configured

Item number	Wood	Price
6290197203	Oak soap, FSC Mix 70%	3.615
6290197205	Oak oil, FSC Mix 70%	3.615
6290197206	Oak light oil, FSC Mix 70%	3.615
6290197207	Smoked oak, oiled, FSC Mix 70%	4.220

Certifications

FSC® certified

Model 6293

C18 Mogensen Shaker Table 220x90 cm



Designed by Børge Mogensen, 1947

Rectangular table with frame and table top in solid wood. Leg mounted with a visible brass screw. Knock-down, delivered unassembled.

Modeldetails

0,22 m³ Packaging dimensions:
55 kg / 48 kg L: 230 cm W: 100 cm H: 10 cm

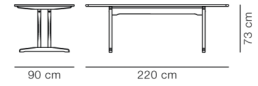

Essential Assortment

Pre-configured

Item number	Wood	Price
6293195203	Oak soap, FSC Mix 70%	4.825
6293195205	Oak oil, FSC Mix 70%	4.825
6293195206	Oak light oil, FSC Mix 70%	4.825
6293195207	Smoked oak, oiled, FSC Mix 70%	5.425

Certifications

FSC® certified

Model 0290

C18 Accessories Additional leaf for 6290, 6293, 6284

Designed by Børge Mogensen

Additional leaf in black lacquered MDF. Brackets in beech wood and black powder coated steel.
Compatible with C18 table width 90 cm and BM84 (6284).

Modeldetails

0,04 m³ Packaging dimensions:
7 kg / 4,5 kg L: 47 cm W: 96 cm H: 16 cm

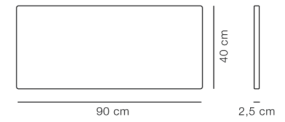

Order configuration

Black lacquered
(each)

385

Model 6775

Islets Table Ø120 cm



Designed by Maria Bruun, 2020

Table with legs and table top of solid hardwood. Legs mounted to table top with metal thread. Knock-down, delivered unassembled. Assembled without the use of screws and tools.

Modeldetails

0,26 m³ Packaging dimensions:
62,5 kg / 54 kg L: 135/84 cm W: 135/36 cm H: 8/36 cm

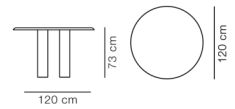

Essential Assortment

Pre-configured

Item number	Wood	Price
67752067300	Oak light oil, FSC Mix 70%	5.505
67752077300	Smoked oak, oiled, FSC Mix 70%	6.120

Certifications

FSC® certified

Model 6568

JG Table Ø140 cm



Designed by Jørgen Gammelgaard, 1984

Table with base in stainless steel or powder coated steel. Table top in stone or linoleum. Table tops in linoleum has chipboard core with solid wood edging. Black linoleum with black colored through wood edge. Grey linoleum with light oiled wood edge. Glides included as standard.

Modeldetails

2,1 m³ Packaging dimensions:
130 kg / 87 kg L: 150/80 cm W: 150/75 cm H: 60/8 cm

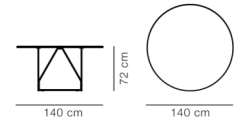

Essential Assortment

Pre-configured

Item number	Surface	Frame	Edge	Price
65682150317950340	Black linoleum	Black lacquer	Black oak	3.095
65682140260150340	Grey linoleum / Vapour 4177	Brushed stainless steel	Natural ash	3.870
65686060017950340	Black Marquina	Black lacquer	without	5.420
65686050060150340	White Carrara	Brushed stainless steel	without	6.195
65686500060150340	Ivory Quartzite	Brushed stainless steel	without	7.590

Order configuration



	Grey linoleum with natural ash edge	Black linoleum with black oak edge	White Carrara	Black Marquina	Ivory Quartzite
Black	3.220	3.095	5.670	5.420	7.135
Stainless steel, brushed	3.870	3.970	6.195	6.425	7.590

Net weight: Linoleum 25 kg, Stone 87 kg.

Model 6569

JG Table 140x140 cm

Modeldetails

 2,1 m³ Packaging dimensions:
 152 kg / 109 kg L: 150/80 cm W: 150/75 cm H: 60/8 cm



Designed by Jørgen Gammelgaard, 1984

Table with legs in stainless steel or powder coated steel. Table top in stone or linoleum. Table tops in linoleum has chipboard core with solid wood edging. Black linoleum with black colored through wood edge. Grey linoleum with light oiled wood edge. Glides included as standard.

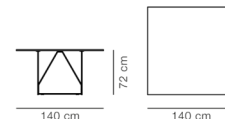

Essential Assortment

Pre-configured

Item number	Surface	Frame	Edge	Price
65692150317950440	Black linoleum	Black lacquer	Black oak	3.095
65692140260150440	Grey linoleum / Vapour 4177	Brushed stainless steel	Natural ash	3.870
65696060017950440	Black Marquina	Black lacquer	without	5.420
65696050060150440	White Carrara	Brushed stainless steel	without	5.885
65696500060150440	Ivory Quartzite	Brushed stainless steel	without	7.745

Order configuration

	Grey linoleum with natural edge	Black linoleum with black oak edge	White Carrara	Black Marquina	Ivory Quartzite
Black	3.290	3.095	5.610	5.420	7.170
Stainless steel, brushed	3.870	4.075	5.885	6.390	7.745

Net weight: Linoleum 31 kg, Stone 109 kg.

Certifications

EN 15372:2016 (L3)

Model 6630

Plan Table Table 160 x 90 cm

Modeldetails

△ 59 kg /
49 kg



Designed by Edward Barber & Jay Osgerby, 2022

Table with base in tubular steel, brushed or powder coated. Tabletop in Fenix NTM laminate, Forbo linoleum, Really textile-plate and oak veneer with straight edge with matching edge band or solid wood with a rounded edge profile. Mounted with plastic glides. Cable management set and cut out available. Cables can be led through the leg and the plastic glide included. Cover for cut out in black powder coated metal or natural saddle leather made from leftovers from production of The Spanish Chair.

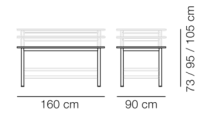

Essential Assortment

Pre-configured

Item number	Surface	Frame	Size	Price
6630323458C4004000	Laminate Fenix NTM Black	Black	160 x 90 cm, height 73 cm	1.325
6630323208C4004000	Black linoleum	Black	160 x 90 cm, height 73 cm	1.325
6630323438B4004000	Oak veneer lacquered, FSC Mix 70%	Black	160 x 90 cm, height 73 cm	1.505
6630323707D5004000	Oak light oil, FSC Mix 70%	Brushed steel	160 x 90 cm, height 73 cm	2.770

Order configuration

Frame: Brushed Steel or standard colours: Black, Modernist green, Bordeaux, Chalk, Signal blue.

	Black Linoleum / Black NTM laminate	Really, Cotton Cream	Oak veneer lacquered	Oak light oil	Smoked oak, oiled
Standard colours ht. 73 cm	1.325	1.625	1.505	2.170	2.410
Brushed Steel ht. 73 cm	2.170	2.410	2.290	2.770	3.015
Standard colours ht. 95 cm	1.990	2.230	2.110	2.410	2.650
Brushed Steel ht. 95 cm	3.015	3.255	3.135	3.615	3.860
Standard colours ht. 105cm	1.990	2.230	2.110	2.410	2.650
Brushed Steel ht. 105 cm	3.015	3.255	3.135	3.615	3.860

Table in height 105 cm is available with castors w. brakes on request.

Spare parts: Glides without felt (R6631G).

Netto weight (73 / 95 / 105 cm):
39 kg / 48 kg / 49 kg

Extra charge for

Cover for cut out in black powder coated steel or natural saddle leather: Incl. cable tray in black powder coated	+350
Other Fenix NTM Laminate – or Forbo Linoleum colours:	+140

Certifications

Oak light oil, smoked oak oiled and oak veneer lacquered is FSC® certified
EN 15372:2023 (L2), ANSI/BIFMA X7.1/M7.1/e3-2019 VOC test (Fenix NTM laminate tabletop)

Model 6631

Plan Table Table 200 x 100 cm



Designed by Edward Barber & Jay Osgerby, 2022

Table with base in tubular steel, brushed or powder coated. Tabletop in Fenix NTM laminate, Forbo linoleum, Really textile-plate and oak veneer with straight edge with matching edge band or solid wood with a rounded edge profile. Mounted with plastic glides. Cable management set and cut out available. Cables can be led through the leg and the plastic glide included. Cover for cut out in black powder coated metal or natural saddle leather made from leftovers from production of The Spanish Chair.

Modeldetails

0,34 m³ Packaging dimensions:
69 kg / 59 kg L: 87/205 cm W: 87/106 cm H: 15/15 cm

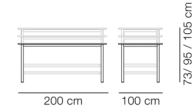

Essential Assortment

Pre-configured

Item number	Surface	Frame	Size	Price
6631325458C4004000	Laminate Fenix NTM Black	Black	200 x 100 cm, height 73 cm	1.505
6631325208C4004000	Black linoleum	Black	200 x 100 cm, height 73 cm	1.505
6631325438B4004000	Oak veneer lacquered, FSC Mix 70%	Black	200 x 100 cm, height 73 cm	1.685
6631325707D5004000	Oak light oil, FSC Mix 70%	Brushed steel	200 x 100 cm, height 73 cm	2.895

Order configuration

Frame: Brushed Steel or standard colours: Black, Modernist green, Bordeaux, Chalk, Signal blue.

	Black Linoleum / Black NTM laminate	Really, Cotton Cream	Oak veneer lacquered	Oak light oil	Smoked oak, oiled
Standard colours ht. 73 cm	1.505	1.930	1.685	2.290	2.530
Brushed Steel ht. 73 cm	2.290	2.530	2.410	2.895	3.135
Standard colours ht. 95 cm	2.110	2.350	2.230	2.530	2.770
Brushed Steel ht. 95 cm	3.135	3.375	3.255	3.735	3.980
Standard colours ht. 105cm	2.110	2.350	2.230	2.530	2.770
Brushed Steel ht. 105 cm	3.135	3.375	3.255	3.735	3.980

Table in height 105 cm is available with castors w. brakes on request.

Spare parts: Glides without felt (R6631G).

Netto weight (73 / 95 / 105 cm):
50 kg / 65 kg / 66 kg

Extra charge for

Cover for cut out in black powder coated steel or natural saddle leather:	+350
Incl. cable tray in black powder coated	
Other Fenix NTM Laminate – or Forbo Linoleum colours:	+235

Certifications

Oak light oil, smoked oak oiled and oak veneer lacquered is FSC® certified
EN 15372:2016 (L3), ANSI/BIFMA X7.1/M7.1/e3-2019 VOC test (Fenix NTM laminate tabletop)

Model 6633

Plan Table Table 240 x 100 cm

Modeldetails

66 kg /
56 kg



Designed by Edward Barber & Jay Osgerby, 2022

Table with base in tubular steel, brushed or powder coated. Tabletop in Fenix NTM laminate, Forbo linoleum, Really textile-plate and oak veneer with straight edge with matching edge band or solid wood with a rounded edge profile. Mounted with plastic glides. Cable management set and cut out available. Cables can be led through the leg and the plastic glide included. Cover for cut out in black powder coated metal or natural saddle leather made from leftovers from production of The Spanish Chair.

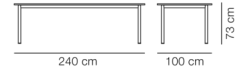

Essential Assortment

Pre-configured

Item number	Surface	Frame	Size	Price
6633337458C4004000	Laminate Fenix NTM Black	Black	240 x 100 cm, height 73 cm	1.745
6633337208C4004000	Black linoleum	Black	240 x 100 cm, height 73 cm	1.745
6633337438B4004000	Oak veneer lacquered, FSC Mix 70%	Black	240 x 100 cm, height 73 cm	1.930
6633337707D5004000	Oak light oil, FSC Mix 70%	Brushed steel	240 x 100 cm, height 73 cm	3.135

Order configuration

Frame: Brushed Steel or standard colours: Black, Modernist green, Bordeaux, Chalk, Signal blue.

	Black Linoleum / Black NTM laminate	Really, Cotton Cream	Oak veneer lacquered	Oak light oil	Smoked oak, oiled
Standard colours ht. 73 cm	1.745	2.170	1.930	2.530	2.770
Brushed Steel ht. 73 cm	2.530	2.770	2.650	3.135	3.375

Spare parts: Glides without felt (R6631G).

Extra charge for

Cover for cut out in black powder coated steel or natural saddle leather: Incl. cable tray in black powder coated	+350
Other Fenix NTM Laminate – or Forbo Linoleum colours:	+470

Certifications

Oak light oil, smoked oak oiled and oak veneer lacquered is FSC® certified
EN 15372:2023 (L2), ANSI/BIFMA X7.1/M7.1/e3-2019 VOC test (Fenix NTM laminate tabletop)

Model 6645

Plan Table Table Ø150 cm



Designed by Edward Barber & Jay Osgerby, 2022

Table with base in tubular steel, brushed or powder coated. Tabletop in Fenix NTM laminate, Forbo linoleum and oak veneer. Table tops are delivered with straight edge with matching edge band. Mounted with plastic glides. Cable management set and cut out available. Cables can be led through the base leg and the plastic glide included. Cover for cut out in black powder coated metal or natural saddle leather made from leftovers from the production of The Spanish Chair.

Modeldetails

△ 59 kg /
49 kg

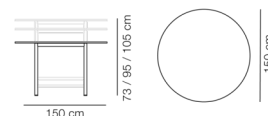

Essential Assortment

Pre-configured

Item number	Surface	Frame	Size	Price
6645217458C4004000	Laminate Fenix NTM Black	Black	Ø150 cm, height 73 cm	2.115
6645217208C4004000	Black linoleum	Black	Ø150 cm, height 73 cm	2.115
6645217438B4004000	Oak veneer lacquered, FSC Mix 70%	Black	Ø150 cm, height 73 cm	2.735
6645217707D5004000	Oak light oil, FSC Mix 70%	Brushed steel	Ø150 cm, height 73 cm	3.690

Order configuration

Frame: Brushed Steel or standard colours: Black, Modernist green, Bordeaux, Chalk, Signal blue.

	Black Linoleum / Black NTM laminate	Oak veneer lacquered	Oak light oil	Smoked oak, oiled
Standard colours ht. 73 cm	2.115	2.735	2.930	3.005
Brushed Steel ht. 73 cm	2.885	3.435	3.690	3.840
Standard colours ht. 95 cm	2.750	3.505	3.770	3.860
Brushed Steel ht. 95 cm	3.580	4.450	4.575	4.805
Standard colours ht. 105cm	2.750	3.505	3.770	3.860
Brushed Steel ht. 105 cm	3.580	4.450	4.575	4.805

Veneer top made from two veneer sheets with a centre joint..

Table in height 105 cm is available with castors w. brakes on request.

Spare parts: Glides without felt (R6631G).

Netto weight (73 / 95 / 105 cm):
40 kg / 48 kg / 49 kg

Extra charge for

Cover for cut out in black powder coated steel or natural saddle leather: Incl. cable tray in black powder coated	+350
Other Fenix NTM Laminate – or Forbo Linoleum colours:	+470

Certifications

Oak veneer lacquered is FSC® certified
ANSI/BIFMA X7.1/M7.1/e3-2019 VOC test (Fenix NTM laminate tabletop)

Model 665A

Plan Table Configuration A, 260 x 100 cm

Modeldetails



Designed by Edward Barber & Jay Osgerby, 2022

Base in tubular steel, brushed or powder coated. Tabletop in Fenix NTM laminate, Forbo linoleum, Really textile-plate or oak veneer table top. Table tops will be delivered with straight edges. Mounted with plastic glides.
Cable management set and cut out available. Cables can be led through the base leg and out through the plastic glider included in the Cable management set. Cover for cut out in black powder coated metal or natural saddle leather made from leftover leather from the production of The Spanish Chair.

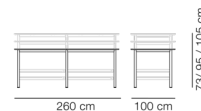

Order configuration

Frame: Brushed Steel or standard colours: Black, Modernist green, Bordeaux, Chalk, Signal blue.

	Black Linoleum / Black NTM laminate	Oak veneer lacquered	Really, Cotton Cream
Standard colours ht. 73 cm	2.410	2.770	3.010
Brushed Steel ht. 73 cm	3.850	4.090	4.340
Standard colours ht. 95 cm	3.250	3.610	3.850
Brushed Steel ht. 95 cm	4.820	5.060	5.300
Standard colours ht. 105cm	3.250	3.610	3.850
Brushed Steel ht. 105 cm	4.820	5.060	5.300

Spare parts: Glides without felt (R6631G).

Extra charge for

Cover for cut out in black powder coated steel or natural saddle leather (2 pcs.)	+705
Incl. 2 cable trays in black powder coated	
Other Fenix NTM Laminate – or Forbo Linoleum colours:	+280

Certifications

Oak veneer lacquered is FSC® certified
EN 15372:2016 (L3), ANSI/BIFMA X7.1/M7.1/e3-2019 VOC test (Fenix NTM laminate tabletop)

Model 665C

Plan Table Configuration C, 320 x 100 cm

Modeldetails



Designed by Edward Barber & Jay Osgerby, 2022

Base in tubular steel, brushed or powder coated. Tabletop in Fenix NTM laminate, Forbo linoleum, Really textile-plate or oak veneer table top. Table tops will be delivered with straight edges. Mounted with plastic glides.
Cable management set and cut out available. Cables can be led through the base leg and out through the plastic glider included in the Cable management set. Cover for cut out in black powder coated metal or natural saddle leather made from leftover leather from the production of The Spanish Chair.

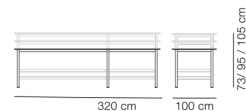

Order configuration

Frame: Brushed Steel or standard colours: Black, Modernist green, Bordeaux, Chalk, Signal blue.

	Black Linoleum / Black NTM laminate	Oak veneer lacquered	Really, Cotton Cream
Standard colours ht. 73 cm	2.830	3.130	3.490
Brushed Steel ht. 73 cm	4.335	4.575	4.880
Standard colours ht. 95 cm	3.665	4.030	4.155
Brushed Steel ht. 95 cm	5.060	5.420	5.780
Standard colours ht. 105cm	3.665	4.030	4.155
Brushed Steel ht. 105 cm	5.060	5.420	5.780

Spare parts: Glides without felt (R6631G).

Extra charge for

Cover for cut out in black powder coated steel or natural saddle leather (2 pcs.)	+705
Incl. 2 cable trays in black powder coated	
Other Fenix NTM Laminate – or Forbo Linoleum colours:	+280

Certifications

Oak veneer lacquered is FSC® certified
EN 15372:2016 (L3), ANSI/BIFMA X7.1/M7.1/e3-2019 VOC test (Fenix NTM laminate tabletop)

Model 665E

Plan Table Configuration E, 380 x 100 cm

Modeldetails



Designed by Edward Barber & Jay Osgerby, 2022

Base in tubular steel, brushed or powder coated. Tabletop in Fenix NTM laminate, Forbo linoleum, Really textile-plate or oak veneer table top. Table tops will be delivered with straight edges. Mounted with plastic glides.
Cable management set and cut out available. Cables can be led through the base leg and out through the plastic glider included in the Cable management set. Cover for cut out in black powder coated metal or natural saddle leather made from leftover leather from the production of The Spanish Chair.

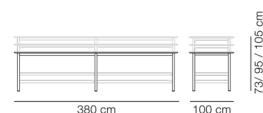

Order configuration

Frame: Brushed Steel or standard colours: Black, Modernist green, Bordeaux, Chalk, Signal blue.

	Black Linoleum / Black NTM laminate	Oak veneer lacquered	Really, Cotton Cream
Standard colours ht. 73 cm	3.250	3.490	3.970
Brushed Steel ht. 73 cm	4.820	5.060	5.420
Standard colours ht. 95 cm	4.080	4.450	4.460
Brushed Steel ht. 95 cm	5.300	5.780	6.260
Standard colours ht. 105cm	4.080	4.450	4.460
Brushed Steel ht. 105 cm	5.300	5.780	6.260

Spare parts: Glides without felt (R6631G).

Extra charge for

Cover for cut out in black powder coated steel or natural saddle leather (2 pcs.)	+705
Incl. 2 cable trays in black powder coated	
Other Fenix NTM Laminate – or Forbo Linoleum colours:	+280

Certifications

Oak veneer lacquered is FSC® certified

EN 15372:2016 (L3), ANSI/BIFMA X7.1/M7.1/e3-2019 VOC test (Fenix NTM laminate tabletop)

Model 665G

Plan Table Configuration G, 440 x 100 cm

Modeldetails

Designed by Edward Barber & Jay Osgerby, 2022



Base in tubular steel, brushed or powder coated. Tabletop in Fenix NTM laminate, Forbo linoleum, Really textile-plate or oak veneer table top. Table tops will be delivered with straight edges. Mounted with plastic glides. Cable management set and cut out available. Cables can be led through the base leg and out through the plastic glider included in the Cable management set. Cover for cut out in black powder coated metal or natural saddle leather made from leftover leather from the production of The Spanish Chair.



Order configuration

Frame: Brushed Steel or standard colours: Black, Modernist green, Bordeaux, Chalk, Signal blue.

	Black Linoleum / Black NTM laminate	Oak veneer lacquered	Really, Cotton Cream
Standard colours ht. 73 cm	3.855	4.455	4.815
Brushed Steel ht. 73 cm	5.775	6.255	6.750
Standard colours ht. 95 cm	5.055	5.655	6.015
Brushed Steel ht. 95 cm	7.350	7.830	8.310
Standard colours ht. 105cm	5.055	5.655	6.015
Brushed Steel ht. 105 cm	7.350	7.830	8.310

Spare parts: Glides without felt (R6631G).

Extra charge for

Cover for cut out in black powder coated steel or natural saddle leather (3 pcs.)	+1.060
Incl. 3 cable trays in black powder coated	
Other Fenix NTM Laminate – or Forbo Linoleum colours:	+420

Certifications

Oak veneer lacquered is FSC® certified
EN 15372:2016 (L3), ANSI/BIFMA X7.1/M7.1/e3-2019 VOC test (Fenix NTM laminate tabletop)

Model 665M

Plan Table Configuration M, 500 x 100 cm

Modeldetails



Designed by Edward Barber & Jay Osgerby, 2022

Base in tubular steel, brushed or powder coated. Tabletop in Fenix NTM laminate, Forbo linoleum, Really textile-plate or oak veneer table top. Table tops will be delivered with straight edges. Mounted with plastic glides. Cable management set and cut out available. Cables can be led through the base leg and out through the plastic glider included in the Cable management set. Cover for cut out in black powder coated metal or natural saddle leather made from leftover leather from the production of The Spanish Chair.



Order configuration

Frame: Brushed Steel or standard colours: Black, Modernist green, Bordeaux, Chalk, Signal blue.

	Black Linoleum / Black NTM laminate	Oak veneer lacquered	Really, Cotton Cream
Standard colours ht. 73 cm	4.330	4.815	5.415
Brushed Steel ht. 73 cm	6.385	6.865	7.465
Standard colours ht. 95 cm	5.525	6.015	6.385
Brushed Steel ht. 95 cm	7.830	8.430	9.150
Standard colours ht. 105cm	5.525	6.015	6.385
Brushed Steel ht. 105 cm	7.830	8.430	9.150

Spare parts: Glides without felt (R6631G).

Extra charge for

Cover for cut out in black powder coated steel or natural saddle leather (3 pcs.)	+1.060
Incl. 3 cable trays in black powder coated	
Other Fenix NTM Laminate – or Forbo Linoleum colours:	+420

Certifications

Oak veneer lacquered is FSC® certified

EN 15372:2016 (L3), ANSI/BIFMA X7.1/M7.1/e3-2019 VOC test (Fenix NTM laminate tabletop)

Model 665K

Plan Table Configuration K, 560 x 100 cm

Modeldetails



Designed by Edward Barber & Jay Osgerby, 2022

Base in tubular steel, brushed or powder coated. Tabletop in Fenix NTM laminate, Forbo linoleum, Really textile-plate or oak veneer table top. Table tops will be delivered with straight edges. Mounted with plastic glides.
Cable management set and cut out available. Cables can be led through the base leg and out through the plastic glider included in the Cable management set. Cover for cut out in black powder coated metal or natural saddle leather made from leftover leather from the production of The Spanish Chair.

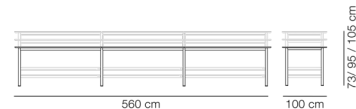

Order configuration

Frame: Brushed Steel or standard colours: Black, Modernist green, Bordeaux, Chalk, Signal blue.

	Black Linoleum / Black NTM laminate	Oak veneer lacquered	Really, Cotton Cream
Standard colours ht. 73 cm	4.695	5.175	5.775
Brushed Steel ht. 73 cm	6.745	7.225	7.830
Standard colours ht. 95 cm	5.885	6.495	6.625
Brushed Steel ht. 95 cm	7.830	8.550	9.270
Standard colours ht. 105cm	5.885	6.495	6.625
Brushed Steel ht. 105 cm	7.830	8.550	9.270

Spare parts: Glides without felt (R6631G).

Extra charge for

Cover for cut out in black powder coated steel or natural saddle leather (3 pcs.)	+1.060
Incl. 3 cable trays in black powder coated	
Other Fenix NTM Laminate – or Forbo Linoleum colours:	+420

Certifications

Oak veneer lacquered is FSC® certified

EN 15372:2016 (L3), ANSI/BIFMA X7.1/M7.1/e3-2019 VOC test (Fenix NTM laminate tabletop)

Model 667B

Plan Table Configuration B, 260 x 120cm

Modeldetails



Designed by Edward Barber & Jay Osgerby, 2022

Base in tubular steel, brushed or powder coated. Tabletop in Fenix NTM laminate, Forbo linoleum or oak veneer table top. Table tops will be delivered with straight edges. Mounted with plastic glides.

Cable management set and cut out available. Cables can be led through the base leg and out through the plastic glider included in the Cable management set. Cover for cut out in black powder coated metal or natural saddle leather made from leftover leather from the production of The Spanish Chair.

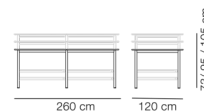

Order configuration

Frame: Brushed Steel or standard colours: Black, Modernist green, Bordeaux, Chalk, Signal blue.

	Black Linoleum / Black NTM laminate	Oak veneer lacquered
Standard colours ht. 73 cm	2.590	2.890
Brushed Steel ht. 73 cm	4.150	4.390
Standard colours ht. 95 cm	3.550	3.790
Brushed Steel ht. 95 cm	4.940	5.180
Standard colours ht. 105cm	3.550	3.790
Brushed Steel ht. 105 cm	4.940	5.180

Spare parts: Glides without felt (R6631G).

Extra charge for

Cover for cut out in black powder coated steel or natural saddle leather (2 pcs.)	+705
Incl. 2 cable trays in black powder coated	
Other Fenix NTM Laminate – or Forbo Linoleum colours:	+280

Certifications

Oak veneer lacquered is FSC® certified

EN 15372:2016 (L3), ANSI/BIFMA X7.1/M7.1/e3-2019 VOC test (Fenix NTM laminate tabletop)

Model 667D

Plan Table Configuration D, 320 x 120cm

Modeldetails



Designed by Edward Barber & Jay Osgerby, 2022

Base in tubular steel, brushed or powder coated. Tabletop in Fenix NTM laminate, Forbo linoleum or oak veneer table top. Table tops will be delivered with straight edges. Mounted with plastic glides.

Cable management set and cut out available. Cables can be led through the base leg and out through the plastic glider included in the Cable management set. Cover for cut out in black powder coated metal or natural saddle leather made from leftover leather from the production of The Spanish Chair.

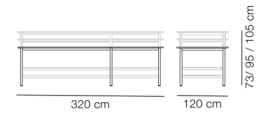

Order configuration

Frame: Brushed Steel or standard colours: Black, Modernist green, Bordeaux, Chalk, Signal blue.

	Black Linoleum / Black NTM laminate	Oak veneer lacquered
Standard colours ht. 73 cm	3.100	3.370
Brushed Steel ht. 73 cm	4.705	4.945
Standard colours ht. 95 cm	3.760	4.005
Brushed Steel ht. 95 cm	5.240	5.540
Standard colours ht. 105cm	3.760	4.005
Brushed Steel ht. 105 cm	5.240	5.540

Spare parts: Glides without felt (R6631G).

Extra charge for

Cover for cut out in black powder coated steel or natural saddle leather (2 pcs.)	+705
Incl. 2 cable trays in black powder coated	
Other Fenix NTM Laminate – or Forbo Linoleum colours:	+280

Certifications

Oak veneer lacquered is FSC® certified

EN 15372:2016 (L3), ANSI/BIFMA X7.1/M7.1/e3-2019 VOC test (Fenix NTM laminate tabletop)

Model 667F

Plan Table Configuration F, 380 x 120cm

Modeldetails



Designed by Edward Barber & Jay Osgerby, 2022

Base in tubular steel, brushed or powder coated. Tabletop in Fenix NTM laminate, Forbo linoleum or oak veneer table top. Table tops will be delivered with straight edges. Mounted with plastic glides.
Cable management set and cut out available. Cables can be led through the base leg and out through the plastic glider included in the Cable management set. Cover for cut out in black powder coated metal or natural saddle leather made from leftover leather from the production of The Spanish Chair.

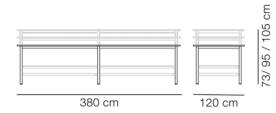

Order configuration

Frame: Brushed Steel or standard colours: Black, Modernist green, Bordeaux, Chalk, Signal blue.

	Black Linoleum / Black NTM laminate	Oak veneer lacquered
Standard colours ht. 73 cm	3.610	3.850
Brushed Steel ht. 73 cm	5.260	5.500
Standard colours ht. 95 cm	3.970	4.220
Brushed Steel ht. 95 cm	5.540	5.900
Standard colours ht. 105cm	3.970	4.220
Brushed Steel ht. 105 cm	5.540	5.900

Spare parts: Glides without felt (R6631G).

Extra charge for

Cover for cut out in black powder coated steel or natural saddle leather (2 pcs.)	+705
Incl. 2 cable trays in black powder coated	
Other Fenix NTM Laminate – or Forbo Linoleum colours:	+280

Certifications

Oak veneer lacquered is FSC® certified
EN 15372:2016 (L3), ANSI/BIFMA X7.1/M7.1/e3-2019 VOC test (Fenix NTM laminate tabletop)

Model 667H

Plan Table Configuration H, 440 x 120cm

Modeldetails



Designed by Edward Barber & Jay Osgerby, 2022

Base in tubular steel, brushed or powder coated. Tabletop in Fenix NTM laminate, Forbo linoleum or oak veneer table top. Table tops will be delivered with straight edges. Mounted with plastic glides.
Cable management set and cut out available. Cables can be led through the base leg and out through the plastic glider included in the Cable management set. Cover for cut out in black powder coated metal or natural saddle leather made from leftover leather from the production of The Spanish Chair.

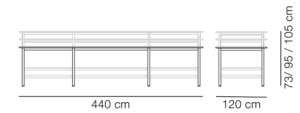

Order configuration

Frame: Brushed Steel or standard colours: Black, Modernist green, Bordeaux, Chalk, Signal blue.

	Black Linoleum / Black NTM laminate	Oak veneer lacquered
Standard colours ht. 73 cm	4.090	4.575
Brushed Steel ht. 73 cm	6.225	6.825
Standard colours ht. 95 cm	5.475	5.835
Brushed Steel ht. 95 cm	7.615	7.975
Standard colours ht. 105cm	5.475	5.835
Brushed Steel ht. 105 cm	7.615	7.975

Spare parts: Glides without felt (R6631G).

Extra charge for

Cover for cut out in black powder coated steel or natural saddle leather (3 pcs.)	+1.060
Incl. 3 cable trays in black powder coated	
Other Fenix NTM Laminate – or Forbo Linoleum colours:	+420

Certifications

Oak veneer lacquered is FSC® certified
EN 15372:2016 (L3), ANSI/BIFMA X7.1/M7.1/e3-2019 VOC test (Fenix NTM laminate tabletop)

Model 667J

Plan Table Configuration J, 500 x 120cm

Modeldetails



Designed by Edward Barber & Jay Osgerby, 2022

Base in tubular steel, brushed or powder coated. Tabletop in Fenix NTM laminate, Forbo linoleum or oak veneer table top. Table tops will be delivered with straight edges. Mounted with plastic glides.
Cable management set and cut out available. Cables can be led through the base leg and out through the plastic glider included in the Cable management set. Cover for cut out in black powder coated metal or natural saddle leather made from leftover leather from the production of The Spanish Chair.

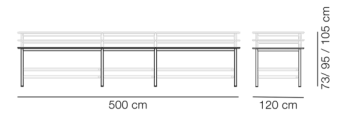

Order configuration

Frame: Brushed Steel or standard colours: Black, Modernist green, Bordeaux, Chalk, Signal blue.

	Black Linoleum / Black NTM laminate	Oak veneer lacquered
Standard colours ht. 73 cm	4.730	5.175
Brushed Steel ht. 73 cm	7.005	7.545
Standard colours ht. 95 cm	5.535	6.025
Brushed Steel ht. 95 cm	8.310	8.900
Standard colours ht. 105cm	5.535	6.025
Brushed Steel ht. 105 cm	8.310	8.900

Spare parts: Glides without felt (R6631G).

Extra charge for

Cover for cut out in black powder coated steel or natural saddle leather (3 pcs.)	+1.060
Incl. 3 cable trays in black powder coated	
Other Fenix NTM Laminate – or Forbo Linoleum colours:	+420

Certifications

Oak veneer lacquered is FSC® certified
EN 15372:2016 (L3), ANSI/BIFMA X7.1/M7.1/e3-2019 VOC test (Fenix NTM laminate tabletop)

Model 667L

Plan Table Configuration L, 560 x 120cm

Modeldetails

Designed by Edward Barber & Jay Osgerby, 2022

Base in tubular steel, brushed or powder coated. Tabletop in Fenix NTM laminate, Forbo linoleum or oak veneer table top. Table tops will be delivered with straight edges. Mounted with plastic glides.
Cable management set and cut out available. Cables can be led through the base leg and out through the plastic glider included in the Cable management set. Cover for cut out in black powder coated metal or natural saddle leather made from leftover leather from the production of The Spanish Chair.

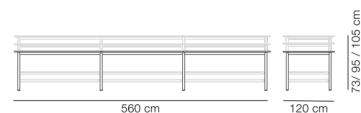

Order configuration

Frame: Brushed Steel or standard colours: Black, Modernist green, Bordeaux, Chalk, Signal blue.

	Black Linoleum / Black NTM laminate	Oak veneer lacquered
Standard colours ht. 73 cm	5.110	5.535
Brushed Steel ht. 73 cm	7.335	7.935
Standard colours ht. 95 cm	5.895	6.265
Brushed Steel ht. 95 cm	8.215	8.695
Standard colours ht. 105cm	5.895	6.265
Brushed Steel ht. 105 cm	8.215	8.695

Spare parts: Glides without felt (R6631G).

Extra charge for

Cover for cut out in black powder coated steel or natural saddle leather (3 pcs.) Incl. 3 cable trays in black powder coated	+1.060
Other Fenix NTM Laminate – or Forbo Linoleum colours:	+420

Certifications

Oak veneer lacquered is FSC® certified
EN 15372:2016 (L3), ANSI/BIFMA X7.1/M7.1/e3-2019 VOC test (Fenix NTM laminate tabletop)

Plan Table - Overview

Model 665A, Configuration: A
MODEL 6652 / 6652 + 1 pcs. 6650

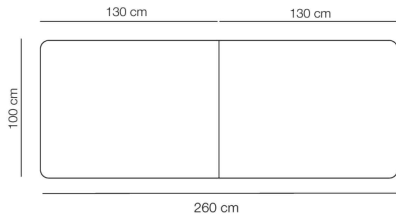

Model 667B, Configuration: B
MODEL 6672 / 6672 + 1 pcs. 6670

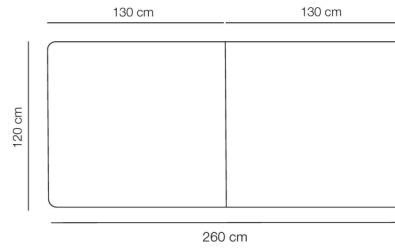

Model 665C, Configuration: C
MODEL 6652 / 6651 + 1 pcs. 6650

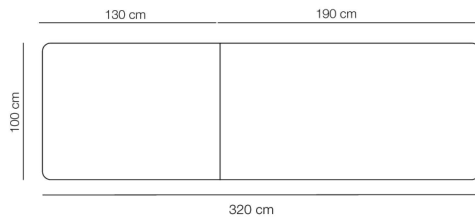

Model 667D, Configuration: D
MODEL 6672 / 6671 + 1 pcs. 6670

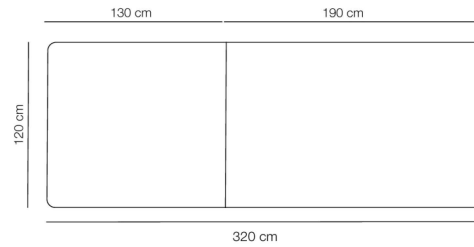

Model 665E, Configuration: E
MODEL 6651 / 6651 + 1 pcs. 6650

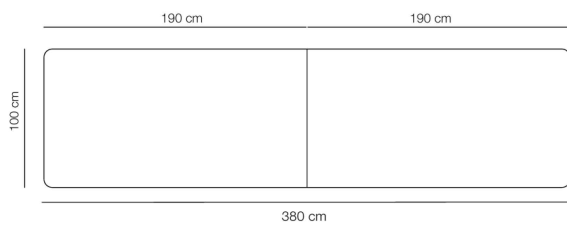

Model 667F, Configuration: F
MODEL 6671 / 6671 + 1 pcs. 6670

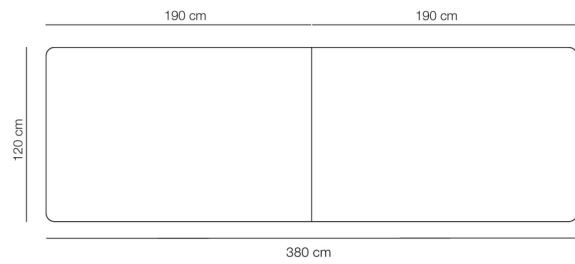

Model 665G, Configuration: G
MODEL 6652 / 6654 / 6652 + 2. pcs. 6650

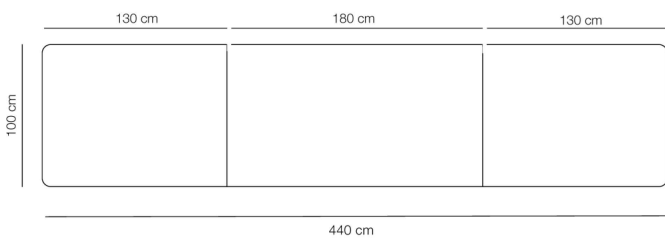

Model 667H, Configuration: H
MODEL 6672 / 6674 / 6672 + 2. pcs. 6670

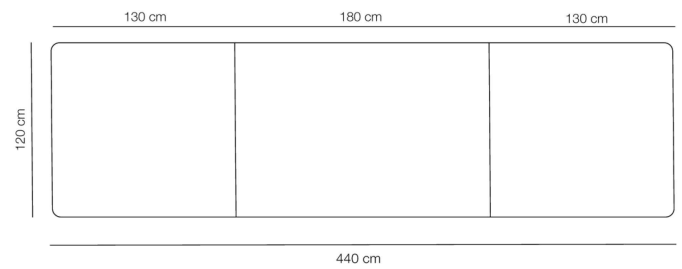

For customer's own configuration, please attach to the order a visual sketch of the desired layout

Plan Table - Overview

Model 665M, Configuration: M
MODEL 6651 / 6655 / 6651 + 2. pcs 6650

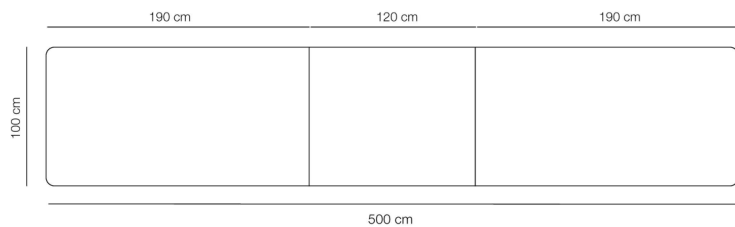

Model 667J, Configuration: J
MODEL 6671 / 6675 / 6671 + 2. pcs 6670

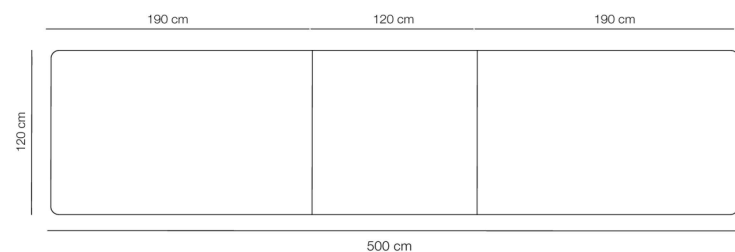

Model 665K, Configuration: K
MODEL 6651 / 6654 / 6651 + 2. pcs 6650

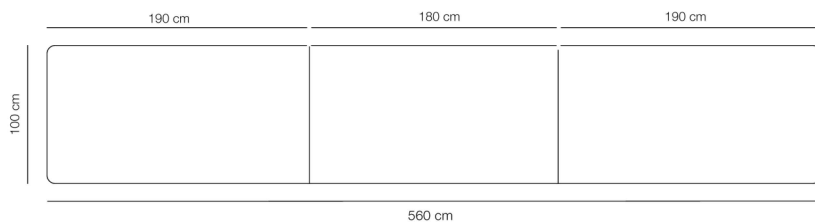

Model 667L, Configuration: L
MODEL 6671 / 6674 / 6671 + 2. pcs 6670

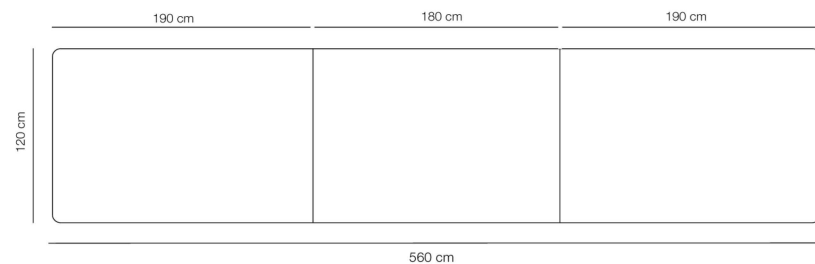

For customer's own configuration, please attach to the order a visual sketch of the desired layout

Model 6680

Plan Wood Table Table 160 x 90 cm

Modeldetails



Designed by Edward Barber & Jay Osgerby, 2025

Table with base in solid wood. Tabletop in Fenix NTM laminate, Forbo linoleum, Really textile-plate or Oak veneer delivered with straight edges or solid wood with a rounded edge profile.

Cable management set and cut out available. Cables can be led down the base leg via a recess. Cover for cut out available in black powder coated metal or natural saddle leather made from leftovers from the production of The Spanish Chair.

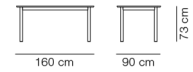

Order configuration

	Black Linoleum / Black NTM laminate	Really, Cotton Cream	Oak veneer lacquered	Oak oil	Oak light oil	Smoked oak, oiled
Oak veneer lacquered	1.910	2.220	2.085			
Oak oil	1.910	2.220		2.315		
Oak light oil	1.910	2.220			2.315	
Smoked oak, oiled	2.055	2.365				2.550

Extra charge for

Cover for cut out in black powder coated steel or natural saddle leather: Incl. cable tray in black powder coated	+495
Other Fenix NTM Laminate – or Forbo Linoleum colours:	+140

Certifications

FSC® certified
EN 15372:2023 (L3)

Model 6681

Plan Wood Table Table 200 x 100 cm

Modeldetails



Designed by Edward Barber & Jay Osgerby, 2025

Table with base in solid wood. Tabletop in Fenix NTM laminate, Forbo linoleum, Really textile-plate or Oak veneer delivered with straight edges or solid wood with a rounded edge profile.

Cable management set and cut out available. Cables can be led down the base leg via a recess. Cover for cut out available in black powder coated metal or natural saddle leather made from leftovers from the production of The Spanish Chair.

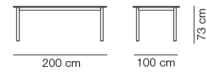

Order configuration

	Black Linoleum / Black NTM laminate	Really, Cotton Cream	Oak veneer lacquered	Oak oil	Oak light oil	Smoked oak, oiled
Oak veneer lacquered	2.255	2.660	2.430			
Oak oil	2.255	2.660		2.665		
Oak light oil	2.255	2.660			2.665	
Smoked oak, oiled	2.400	2.805				2.895

Extra charge for

Cover for cut out in black powder coated steel or natural saddle leather: Incl. cable tray in black powder coated	+495
Other Fenix NTM Laminate – or Forbo Linoleum colours:	+235

Certifications

FSC® certified
EN 15372:2023 (L3)

Model 6624

Plan Table Column 70x60 cm



Designed by Edward Barber & Jay Osgerby, 2023

Column table. Frame in powder coated steel and aluminum. Table top in stone with a full rounded edge profile or Fenix NTM laminate, Forbo linoleum or solid wood with a straight edge. Delivered with felt glides. Available in different heights.

Modeldetails

0,08 m³ Packaging dimensions:
46 kg / 41 kg L: 55/21/81 cm W: 55/128/71 cm H: 10/17/11 cm

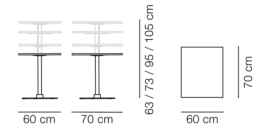

Essential Assortment

Pre-configured

Item number	Surface	Frame	Height	Price
66243417074000500	Oak light oil, FSC Mix 70%	Black	105 cm	900
66243417075377300	Oak light oil, FSC Mix 70%	Modernist green	73 cm	900

Order configuration

Height: 63, 73, 95 or 105 cm.

	White Carrara	Black Linoleum / Black NTM laminate	Oak light oil	Oak lacquered	Smoked oak, oiled
Black	1.205	600	900	900	1.025
Modernist green	1.205	600	900	900	1.025
Bordeaux	1.205	600	900	900	1.025
Chalk	1.205	600	900	900	1.025
Signal Blue	1.205	600	900	900	1.025

Net weight (63 / 73 / 95 / 105 cm):

Stone 40 / 40 / 40 / 41 kg., Laminate 22 / 22 / 23 / 23 kg., Wood 23 / 23 / 24 / 24 kg.

Extra charge for

Frame in brushed stainless steel: +350
Other Fenix NTM Laminate – or Forbo Linoleum colours: +115

Certifications

Oak is FSC® certified

EN 15372:2016 (L3), ANSI/BIFMA X7.1/M7.1/e3-2019 VOC test (Fenix NTM laminate tabletop)

Model 6627

Plan Table Column Ø72 cm



Designed by Edward Barber & Jay Osgerby, 2023

Column table. Frame in powder coated steel and aluminum. Table top in stone with a full rounded edge profile or Fenix NTM laminate, Forbo linoleum or solid wood with a straight edge. Delivered with felt glides. Available in different heights.

Modeldetails

0,08 m³ Packaging dimensions:
45 kg / 40 kg L: 55/21/83 cm W: 55/128/83 cm H: 10/17/11 cm



Essential Assortment

Pre-configured

Item number	Surface	Frame	Height	Price
66273437075377300	Oak light oil, FSC Mix 70%	Modernist green	73 cm	960
66273437095380500	Smoked oak, oiled, FSC Mix 70%	Bordeaux	105 cm	1.085

Order configuration

Height: 63, 73, 95 or 105 cm.

	White Carrara	Black Linoleum / Black NTM laminate	Oak light oil	Oak lacquered	Smoked oak, oiled
Black	1.420	675	960	960	1.085
Modernist green	1.420	675	960	960	1.085
Bordeaux	1.420	675	960	960	1.085
Chalk	1.420	675	960	960	1.085
Signal Blue	1.420	675	960	960	1.085

Net weight (63 / 73 / 95 / 105 cm):

Stone 39 / 39 / 40 / 40 kg., Laminate 22 / 22 / 23 / 23 kg., Wood 23 / 23 / 24 / 24 kg.

Extra charge for

Frame in brushed stainless steel: +350
Other Fenix NTM Laminate – or Forbo Linoleum colours: +115

Certifications

Oak is FSC® certified

EN 15372:2016 (L3), ANSI/BIFMA X7.1/M7.1/e3-2019 VOC test (Fenix NTM laminate tabletop)

Model 6629



Plan Table Column Ø90 cm

Designed by Edward Barber & Jay Osgerby, 2023

Column table. Frame in powder coated steel and aluminum. Table top in stone with a full rounded edge profile or Fenix NTM laminate, Forbo linoleum or solid wood with a straight edge. Delivered with felt glides. Available in different heights.

Modeldetails

0,09 m³ Packaging dimensions:
57 kg / 52 kg L: 55/21/101 cm W: 55/128/101 cm H: 10/17/11 cm



Essential Assortment

Pre-configured

Item number	Surface	Frame	Height	Price
66291437074000500	Oak light oil, FSC Mix 70%	Black	105 cm	1.145
66291437095387300	Smoked oak, oiled, FSC Mix 70%	Bordeaux	73 cm	1.205

Order configuration

Height: 63, 73, 95 or 105 cm.

	White Carrara	Black Linoleum / Black NTM laminate	Oak light oil	Oak lacquered	Smoked oak, oiled
Black	1.805	840	1.145	1.145	1.205
Modernist green	1.805	840	1.145	1.145	1.205
Bordeaux	1.805	840	1.145	1.145	1.205
Chalk	1.805	840	1.145	1.145	1.205
Signal Blue	1.805	840	1.145	1.145	1.205

Net weight (63 / 73 / 95 / 105 cm):

Stone 51 / 52 / 52 / 52 kg., Laminate 25 / 25 / 25 / 26 kg., Wood 27 / 27 / 27 / 28 kg.

Extra charge for

Frame in brushed stainless steel: +350
Other Fenix NTM Laminate – or Forbo Linoleum colours: +115

Certifications

Oak is FSC® certified

EN 15372:2016 (L3), ANSI/BIFMA X7.1/M7.1/e3-2019 VOC test (Fenix NTM laminate tabletop)

Model 6622

Plan Table Column Ø120 cm

Modeldetails

0,89 m³ Packaging dimensions:
69 kg / L: 8/70/59/125 cm W: 8/70/59/125
65 kg cm H: 69/7/1/3 cm



Designed by Edward Barber & Jay Osgerby, 2025

Column table. Frame in powder coated steel and aluminum. Table top in Fenix NTM laminate, Forbo linoleum or solid wood with a straight edge. Delivered with felt glides.



Order configuration

	Black Linoleum / Black NTM laminate	Oak light oil	Oak lacquered	Smoked oak, oiled
Black	1.620	2.085	2.085	2.430
Modernist green	1.620	2.085	2.085	2.430
Bordeaux	1.620	2.085	2.085	2.430
Chalk	1.620	2.085	2.085	2.430
Signal Blue	1.620	2.085	2.085	2.430

Extra charge for

Column and cover plate on base plate in brushed stainless steel: +575
Other Fenix NTM Laminate – or Forbo Linoleum colours: +140

Certifications

Oak is FSC® certified
EN 15372:2023 (L3), ANSI/BIFMA X7.1/M7.1/e3-2019 VOC test (Fenix NTM laminate tabletop)

Model 6625

Plan Table Column Ø150 cm

Modeldetails

1,14 m³ Packaging dimensions:
79 kg / 75 kg L: 8/70/59/155 cm W: 8/70/59/155 cm H: 69/7/1/3 cm



Designed by Edward Barber & Jay Osgerby, 2025

Column table. Frame in powder coated steel and aluminum. Table top in Fenix NTM laminate, Forbo linoleum or solid wood with a straight edge. Delivered with felt glides.



Order configuration

	Black Linoleum / Black NTM laminate	Oak light oil	Oak lacquered	Smoked oak, oiled
Black	2.025	2.490	2.490	2.840
Modernist green	2.025	2.490	2.490	2.840
Bordeaux	2.025	2.490	2.490	2.840
Chalk	2.025	2.490	2.490	2.840
Signal Blue	2.025	2.490	2.490	2.840

Extra charge for

Column and cover plate on base plate in brushed stainless steel: +575
Other Fenix NTM Laminate – or Forbo Linoleum colours: +235

Certifications

Oak is FSC® certified
EN 15372:2023 (L3), ANSI/BIFMA X7.1/M7.1/e3-2019 VOC test (Fenix NTM laminate tabletop)

Model 6438

Post Table 225x100 cm



Designed by Cecilie Manz, 2019

Legs and table top in solid wood. Knock-down, delivered unassembled.

Modeldetails

0,41 m³ Packaging dimensions:
80 kg / L: 108/234 cm W: 79/108 cm H:
71,5 kg 15/11 cm

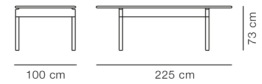

Essential Assortment

Pre-configured

Item number	Wood	Price
6438452206	Oak light oil, FSC Mix 70%	4.120
6438452207	Smoked oak, oiled, FSC Mix 70%	4.990

Order configuration

	Oak soap	Oak oiled	Oak light oil	Oak lacquered	Smoked oak, oiled
	4.455	4.120	4.120	4.670	4.990

Certifications

FSC® certified
EN 15372:2016 (L2)

Model 6441

Post Table 270x100 cm



Designed by Cecilie Manz, 2019

Legs and table top in solid wood. Knock-down, delivered unassembled.

Modeldetails

0,5 m³ Packaging dimensions:
94,5 kg / 80 kg L: 108/274 cm W: 79/108 cm H: 15/11 cm

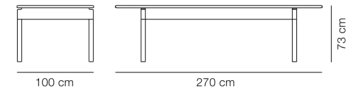

Essential Assortment

Pre-configured

Item number	Wood	Price
6441453206	Oak light oil, FSC Mix 70%	4.990
6441453207	Smoked oak, oiled, FSC Mix 70%	6.240

Order configuration

	Oak soap	Oak oiled	Oak light oil	Oak lacquered	Smoked oak, oiled
	5.425	4.990	4.990	5.640	6.240

Certifications

FSC® certified
EN 15372:2016 (L2)

Model 6442

Post Table 320x100 cm



Designed by Cecilie Manz, 2019

Legs and table top in solid wood. Knock-down, delivered unassembled.

Modeldetails

0,52 m³ Packaging dimensions:
106 kg / L: 108/329 cm W: 79/108 cm H:
85,5 kg 15/11 cm

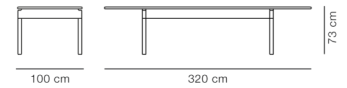

Essential Assortment

Pre-configured

Item number	Wood	Price
6442450203	Oak soap, FSC Mix 70%	6.990

Order configuration

	Oak soap	Oak oiled	Oak light oil	Oak lacquered	Smoked oak, oiled
	6.990	6.990	6.990	7.220	8.390

Certifications

FSC® certified
EN 15372:2016 (L2)

Model 5106

ND106 Trisse Table Ø68 cm



Designed by Nanna Ditzel, 1962

Table in solid wood. Table top, column and base are joined with steel rod. Knock-down, delivered unassembled.

Modeldetails

0,04 m³ Packaging dimensions:
14,9 kg / L: 70 / 70 / 55 cm W: 70 / 12 / 55 cm
12,4 kg H: 4 / 12 / 5 cm

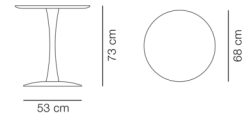

Essential Assortment

Pre-configured

Item number	Wood	Price
510630920500	Oak oil, FSC Mix 70%	1.040

Order configuration

	Oak soap	Oak oiled	Oak light oil	Smoked oak, oiled	Oak clear lacquered
	1.040	1.040	1.040	1.510	1.180

Certifications

FSC® certified

Model 5107

ND107 Trisse Table Ø75 cm



Designed by Nanna Ditzel, 1962

Table in solid wood. Table top, column and base are joined with steel rod. Knock-down, delivered unassembled.

Modeldetails

0,05 m³ Packaging dimensions:
15,6 kg / 13 kg L: 77 / 70 / 55 cm W: 77 / 12 / 55 cm
H: 4 / 12 / 5 cm



Essential Assortment

Pre-configured

Item number	Wood	Price
510731020500	Oak oil, FSC Mix 70%	1.230

Order configuration

	Oak soap	Oak oiled	Oak light oil	Smoked oak, oiled	Oak clear lacquered
	1.230	1.230	1.230	1.755	1.405

Certifications

FSC® certified

Model 5109

ND109 Trisse Table Ø90 cm



Designed by Nanna Ditzel, 1962

Table in solid wood. Table top, column and base are joined with steel rod. Knock-down, delivered unassembled.

Modeldetails

0,11 m³ Packaging dimensions:
19 kg / 16 kg L: 92 / 70 / 55 cm W: 92 / 12 / 55 cm
H: 4 / 12 / 5 cm

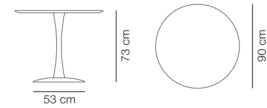

Essential Assortment

Pre-configured

Item number	Wood	Price
510911520500	Oak oil, FSC Mix 70%	1.340

Order configuration

	Oak soap	Oak oiled	Oak light oil	Smoked oak, oiled	Oak clear lacquered
	1.340	1.340	1.340	1.885	1.560

Certifications

FSC® certified

Model 5108



ND108 Trisse Bar Table Ø68 cm

Designed by Nanna Ditzel

Table in solid wood. Table top, column and base are joined with steel rod. Knock-down, delivered unassembled.

Modeldetails

 kg

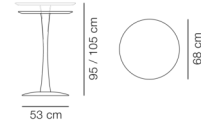

Essential Assortment

Pre-configured

Item number	Wood	Price
510836720500	Oak oil, FSC Mix 70%	1.305

Order configuration

	Oak soap	Oak oiled	Oak light oil	Smoked oak, oiled	Oak clear lacquered
	1.305	1.305	1.305	1.885	1.455

Certifications

FSC® certified
EN 15372:2023 (L3)

Coffee & Side Tables

Model 5367

BM67 Coffee Table



Designed by Børge Mogensen, 1956

Coffee table. Frame in solid wood, with brackets in solid brass or powder coated steel. Table top in solid oak. Knock-down, delivered unassembled.

Modeldetails

0,1 m³ Packaging dimensions:
18 kg / L: 143 cm W: 58 cm H: 12 cm
14,75 kg

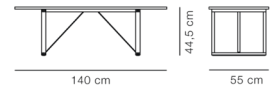

Essential Assortment

Pre-configured

Item number	Wood	Frame	Price
536710790313300	Oak light oil	Brackets in brass	1.805

Order configuration

	Oak soap	Oak oil	Oak light oil	Smoked oak, oiled
Brackets: Black	1.805	1.805	1.805	2.235
Brackets: Brass	1.805	1.805	1.805	2.235

Model 5271

BM80 Mogensen Coffee Table 90 x 90 cm



Designed by Børge Mogensen, 1961

Square coffee table with frame and table top in solid wood. Leg mounted with a visible brass screw. Knock-down, delivered unassembled.

Modeldetails

0,14 m³ Packaging dimensions:
30 kg / 21 kg L: 100/65 cm W: 100/60 cm H: 6/18 cm

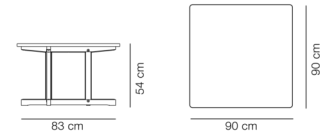

Essential Assortment

Pre-configured

Item number	Wood	Price
5271058203	Oak soap, FSC Mix 70%	2.010
5271058205	Oak oil, FSC Mix 70%	2.010
5271058206	Oak light oil, FSC Mix 70%	2.010
5271058207	Smoked oak, oiled, FSC Mix 70%	2.450

Certifications

FSC® certified
EN 15372:2016 (L3)

Model 5272

BM80 Mogensen Coffee Table Ø120 cm



Designed by Børge Mogensen, 1961

Round coffee table with frame and table top in solid wood. Leg mounted with a visible brass screw. Knock-down, delivered unassembled.

Modeldetails

0,18 m³ Packaging dimensions:
40 kg / 25 kg L: 130/65 cm W: 130/60 cm H: 6/18 cm

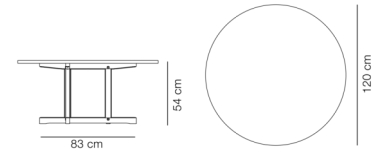

Essential Assortment

Pre-configured

Item number	Wood	Price
5272225203	Oak soap, FSC Mix 70%	2.365
5272225205	Oak oil, FSC Mix 70%	2.365
5272225206	Oak light oil, FSC Mix 70%	2.365
5272225207	Smoked oak, oiled, FSC Mix 70%	2.805

Certifications

FSC® certified
EN 15372:2016 (L3)

Model 5190

Insula Coffee Table 72x76 cm



Designed by Ernst & Jensen, 2009

Coffee table in solid aluminum finished with textured powder coating or Brushed aluminium with clear matt powder coating. Mounted with plastic glides. Knock down, delivered unassembled.

Modeldetails

0,05 m³ Packaging dimensions:
12 kg / 10 kg L: 86 cm W: 77 cm H: 6 cm

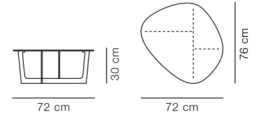

Essential Assortment

Pre-configured

Item number	Surface	Price
51903013013000	Aluminium, textured black lacquer	900
51904024023000	Brushed aluminium, clear matt powder coating	960

Certifications

EN 15372:2008 (L2)

Model 5191

Insula Coffee Table 95x98 cm

Designed by Ernst & Jensen, 2009

Coffee table in solid aluminum finished with textured powder coating or Brushed aluminium with clear matt powder coating. Mounted with plastic glides. Knock down, delivered unassembled.



Modeldetails

0,08 m³ Packaging dimensions:
19 kg / 16 kg L: 110 cm W: 95 cm H: 6 cm

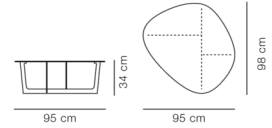

Essential Assortment

Pre-configured

Item number	Surface	Price
51913013013400	Aluminium, textured black lacquer	1.205
51914024023400	Brushed aluminium, clear matt powder coating	1.325

Certifications

EN 15372:2008 (L2)

Model 5192

Insula Coffee Table 118x121 cm



Designed by Ernst & Jensen, 2009

Coffee table in solid aluminum finished with textured powder coating. Mounted with plastic glides. Knockdown, delivered assembled.

Modeldetails

0,6 m³ Packaging dimensions:
30 kg / 26 kg L: 126 cm W: 103 cm H: 45 cm

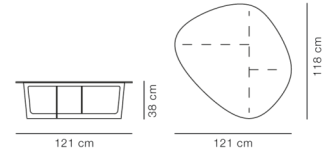

Essential Assortment

Pre-configured

Item number	Surface	Price
51923013013800	Aluminium, textured black lacquer	2.320

Certifications

EN 15372:2008 (L2)

Model 5198

Insula Piccolo Table Side table



Designed by Ernst & Jensen, 2014

Side table in two heights. Tabletop in aluminum, base in steel. Finished with textured powder coating. Mounted with natural fibre glides, as an alternative to felt. Please specify table height.

Modeldetails

0,2 m³ Packaging dimensions:
15,5 kg / 12 kg L: 47 cm W: 46 cm H: 76 cm

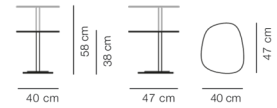

Essential Assortment

Pre-configured

Item number	Surface	Height	Price
51983013015800	Aluminium, textured black lacquer	58 cm	420

Order configuration

Frame: Black aluminium.

Table top:
Aluminium
black

Height 38 cm	420
Height 58 cm	420

Model 6770

Islets Side Table 40x40 cm



Designed by Maria Bruun, 2020

Side table with legs and table top of solid hardwood. Legs mounted to table top with metal thread. Knock-down, delivered assembled.

Modeldetails

0,05 m³ Packaging dimensions:
11 kg / 9 kg L: 55/55 cm W: 55/21 cm H: 8/21 cm

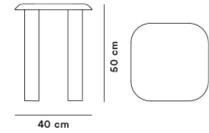

Essential Assortment

Pre-configured

Item number	Wood	Price
67702065200	Oak light oil, FSC Mix 70%	1.590
67702075200	Smoked oak, oiled, FSC Mix 70%	1.725

Certifications

FSC® certified
EN 15372:2016 (L3)

Model 6772

Islets Coffee Table 110x110 cm

Designed by Maria Bruun, 2020

Coffee table with legs and table top of solid hardwood. Legs mounted to table top with metal thread. Knock-down, delivered assembled.



Modeldetails

0,15 m³ Packaging dimensions:
35,5 kg / 28 kg L: 125/35 cm W: 125/25 cm H: 8/25 cm

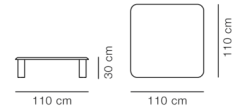

Essential Assortment

Pre-configured

Item number	Wood	Price
67722063000	Oak light oil, FSC Mix 70%	3.315
67722073000	Smoked oak, oiled, FSC Mix 70%	3.450

Certifications

FSC® certified
EN 15372:2016 (L3)

Model 6558

JG Coffee Table Ø98 cm



Designed by Jørgen Gammelgaard, 1962

Coffee table with base in solid aluminium, brushed and finished with a clear powder coating. Tabletop in 12 mm tempered low-iron glass. Mounted with plastic glides. Knock-down, delivered unassembled.

Modeldetails

0,12 m³ Packaging dimensions:
33 kg / 30 kg L: 102/58 cm W: 102/31 cm H: 8/18 cm

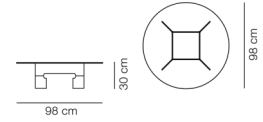

Essential Assortment

Pre-configured

Item number	Surface	Frame	Price
65581855669804000	12 mm tempered glass	Brushed aluminium with clear powder lacq.	2.170

Model 6804

Niveau Coffee Table Ø45 cm



Designed by Cecilie Manz, 2023

Table top in 20 mm stone. Base in solid wood done with a hollow construction. Table top is attached to base with metal thread. Delivered with felt glides. Delivered disassembled. Available in different heights.

Modeldetails

0,08 m³ Packaging dimensions:
29 kg / 17 kg L: 32/57 cm W: 32/58 cm H: 42/11 cm

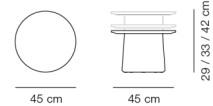

Essential Assortment

Pre-configured

Item number	Surface	Frame	Size	Price
680460618690779	Black Marquina	Ash brown stained oil treated, FSC Mix 70%	Ø45 cm, height 29 cm	1.205
680460618690879	Black Marquina	Ash brown stained oil treated, FSC Mix 70%	Ø45 cm, height 42 cm	1.205
680461118590779	Tundra Grey	Ash oil treated, FSC Mix 70%	Ø45 cm, height 29 cm	1.205
680461118590879	Tundra Grey	Ash oil treated, FSC Mix 70%	Ø45 cm, height 42 cm	1.205
680460618691279	Black Marquina	Ash brown stained oil treated, FSC Mix 70%	Ø45 cm, height 33 cm	1.205
680461118591279	Tundra Grey	Ash oil treated, FSC Mix 70%	Ø45 cm, height 33 cm	1.205

Order configuration

Height: 29 or 42 cm.

	Tundra Grey	Black Marquina
Ash oil treated	1.205	1.260
Ash brown stained	1.260	1.205

Certifications

FSC® certified
EN 15372:2016 (L2)

Model 6806

Niveau Coffee Table Ø61 cm



Designed by Cecilie Manz, 2023

Table top in 20 mm stone. Base in solid wood done with a hollow construction. Table top is attached to base with metal thread. Delivered with felt glides. Delivered disassembled.

Model details

0,1 m³ Packaging dimensions:
32,5 kg / 23 kg L: 32/73 cm W: 32/74 cm H: 42/11 cm

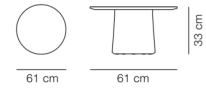

Essential Assortment

Pre-configured

Item number	Surface	Frame	Size	Price
680660618690679	Black Marquina	Ash brown stained oil treated, FSC Mix 70%	Ø61 cm, height 33 cm	1.565
680661118590679	Tundra Grey	Ash oil treated, FSC Mix 70%	Ø61 cm, height 33 cm	1.565

Order configuration

	Tundra Grey	Black Marquina
Ash oil treated	1.565	1.630
Ash brown stained	1.630	1.565

Certifications

FSC® certified
EN 15372:2016 (L2)

Model 6811

Niveau Coffee Table Ø110 cm



Designed by Cecilie Manz, 2023

Table top in 20 mm sten. Base in solid wood done with a hollow construction. Table top is attached to base with metal thread. Delivered with felt glides. Delivered disassembled.

Modeldetails

0,31 m³ Packaging dimensions:
112 kg / L: 62/122 cm W: 62/123 cm H:
68 kg 38/11 cm

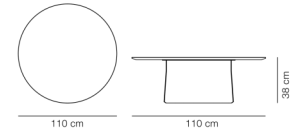

Essential Assortment

Pre-configured

Item number	Surface	Frame	Size	Price
681160618690979	Black Marquina	Ash brown stained oil treated, FSC Mix 70%	Ø110 cm, height 38 cm	3.615
681161118590979	Tundra Grey	Ash oil treated, FSC Mix 70%	Ø110 cm, height 38 cm	3.615

Order configuration

	Grey Tundra	Black Marquina
Ash oil treated	3.615	3.675
Ash brown stained	3.675	3.615

Certifications

FSC® certified
EN 15372:2016 (L2)

Model 6751

Pal Side Table Ø37.5 cm



Designed by Keiji Takeuchi, 2020

Side table with table top in solid wood, base in stainless steel or powder coated steel. Table top is attached to base with metal thread. Delivered disassembled. Mounted with felt glides. Available in different heights.

Modeldetails

0,07 m³ Packaging dimensions:
8,6 kg / 7,1 kg L: 41/32 cm W: 41/32 cm H: 6/
(41/48/55) cm

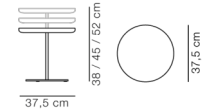

Essential Assortment

Pre-configured

Item number	Wood	Frame	Size	Price
675120617938300	Oak light oil, FSC Mix 70%	Black lacquer	Height 45 cm	485
675116417938300	Walnut oiled	Black lacquer	Height 45 cm	610
675120660138300	Oak light oil, FSC Mix 70%	Brushed stainless steel	Height 45 cm	670
675116460138300	Walnut oiled	Brushed stainless steel	Height 45 cm	795

Order configuration

Available in three heights: 38, 45 or 52 cm.

	Oak light oil	Oak lacquered	Oak black lacquered	Walnut oil	Walnut lacquered
Black	485	530	530	610	750
Stainless steel, brushed	670	695	695	795	925

Certifications

Oak is FSC® certified
EN 15372:2016 (L2)

Model 6755

Pal Side Table Ø44 cm



Designed by Keiji Takeuchi, 2020

Sidetable with table top in solid wood, base in stainless steel or powder coated steel. Table top is attached to base with metal thread. Delivered disassembled. Mounted with felt glides. Available in different heights.

Modeldetails

0,07 m³ Packaging dimensions:
9,25 kg / 7,75 kg L: 48/32 cm W: 48/32 cm H: 6/
(41/48/55) cm

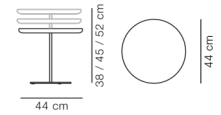

Essential Assortment

Pre-configured

Item number	Wood	Frame	Size	Price
675520617938700	Oak light oil, FSC Mix 70%	Black lacquer	Height 52 cm	560
675516417938700	Walnut oiled	Black lacquer	Height 52 cm	690
675520660138700	Oak light oil, FSC Mix 70%	Brushed stainless steel	Height 52 cm	745
675516460138700	Walnut oiled	Brushed stainless steel	Height 52 cm	885

Order configuration

Available in three heights: 38, 45 or 52 cm.

	Oak light oil	Oak lacquered	Oak black lacquered	Walnut oil	Walnut lacquered
Black	560	590	590	690	830
Stainless steel, brushed	745	760	760	885	1.015

Certifications

Oak is FSC® certified
EN 15372:2016 (L2)

Model 6798

Piloti Wood Coffee Table Nest of tables

Designed by Hugo Passos, 2016



Coffee tables with legs and table top in solid hardwood. Legs mounted to table top with metal thread. Knock-down, delivered unassembled. Assembled without the use of screws and tools.

Essential Assortment

Pre-configured

Item number	Combination	Wood	Price
6798011206	Piloti Small nest, 6700 (H35) + 6705 (H41)	Oak light oil, FSC Mix 70%	735
6798011205	Piloti Small nest, 6700 (H35) + 6705 (H41)	Oak oil, FSC Mix 70%	735
6798011207	Piloti Small nest, 6700 (H35) + 6705 (H41)	Smoked oak, oiled, FSC Mix 70%	860
6798012206	Piloti Medium nest, 6705 (H41) + 6715 (H35)	Oak light oil, FSC Mix 70%	1.105
6798012205	Piloti Medium nest, 6705 (H41) + 6715 (H35)	Oak oil, FSC Mix 70%	1.105
6798012207	Piloti Medium nest, 6705 (H41) + 6715 (H35)	Smoked oak, oiled, FSC Mix 70%	1.230
6798013206	Piloti Large nest, 6720 (H41) + 6725 (H35)	Oak light oil, FSC Mix 70%	1.475
6798013205	Piloti Large nest, 6720 (H41) + 6725 (H35)	Oak oil, FSC Mix 70%	1.475
6798013207	Piloti Large nest, 6720 (H41) + 6725 (H35)	Smoked oak, oiled, FSC Mix 70%	1.595

Certifications

FSC® certified
EN 15372:2016 (L1)

Model 6700

Piloti Wood Coffee Table 39x31 cm



Designed by Hugo Passos, 2016

Legs and table top in solid hardwood. Legs mounted to table top with metal thread. Knock-down, delivered unassembled. Assembled without the use of screws and tools. Available in two heights, please specify 35 cm or 41 cm.

Model details

0,02 m³ Packaging dimensions:
3,3 kg / 2,3 kg L: 47 cm W: 38 cm H: 10 cm

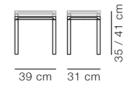

Essential Assortment

Pre-configured

Item number	Wood	Height	Price
67002063500	Oak light oil, FSC Mix 70%	35 cm	365
67002243500	Oak black lacquer, FSC Mix 70%	35 cm	365
67002073500	Smoked oak, oiled, FSC Mix 70%	35 cm	390

Order configuration

Height: 35 or 41 cm.

Oak soap	Oak oiled	Oak light oil	Oak lacquered	Oak black lacquered	Smoked oak, oiled
425	365	365	500	365	390

Certifications

FSC® certified
EN 15372:2016 (L1)

Model 6705

Piloti Wood Coffee Table 46.5x39 cm



Designed by Hugo Passos, 2016

Legs and table top in solid hardwood. Legs mounted to table top with metal thread. Knock-down, delivered unassembled. Assembled without the use of screws and tools. Available in two heights, please specify 35 cm or 41 cm.

Model details

0,03 m³ Packaging dimensions:
4,7 kg / 2,8 kg L: 56 cm W: 46 cm H: 10 cm

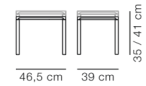

Essential Assortment

Pre-configured

Item number	Wood	Height	Price
67052064100	Oak light oil, FSC Mix 70%	41 cm	515
67052244100	Oak black lacquer, FSC Mix 70%	41 cm	515
67052074100	Smoked oak, oiled, FSC Mix 70%	41 cm	575

Order configuration

Height: 35 or 41 cm.

	Oak soap	Oak oiled	Oak light oil	Oak lacquered	Oak black lacquered	Smoked oak, oiled
	570	515	515	645	515	575

Certifications

FSC® certified
EN 15372:2016 (L1)

Model 6715

Piloti Wood Coffee Table 120x39 cm



Designed by Hugo Passos, 2016

Legs and table top in solid hardwood. Legs mounted to table top with metal thread. Knock-down, delivered unassembled. Assembled without the use of screws and tools. Available in two heights, please specify 35 cm or 41 cm.

Model details

0,06 m³ Packaging dimensions:
9,5 kg / 6,3 kg L: 128 cm W: 46 cm H: 10 cm

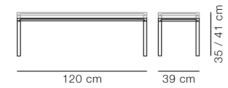

Essential Assortment

Pre-configured

Item number	Wood	Height	Price
67152063500	Oak light oil, FSC Mix 70%	35 cm	780
67152243500	Oak black lacquer, FSC Mix 70%	35 cm	780
67152073500	Smoked oak, oiled, FSC Mix 70%	35 cm	910

Order configuration

Height: 35 or 41 cm.

	Oak soap	Oak oiled	Oak light oil	Oak lacquered	Oak black lacquered	Smoked oak, oiled
	905	780	780	980	780	910

Certifications

FSC® certified
EN 15372:2016 (L1)

Model 6720

Piloti Wood Coffee Table 75x75 cm



Designed by Hugo Passos, 2016

Legs and table top in solid hardwood. Legs mounted to table top with metal thread. Knock-down, delivered unassembled. Assembled without the use of screws and tools. Available in two heights, please specify 35 cm or 41 cm.

Modeldetails

0,06 m³ Packaging dimensions:
11,7 kg / 10 kg L: 82 cm W: 81 cm H: 10 cm

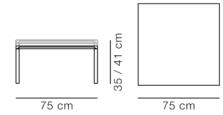

Essential Assortment

Pre-configured

Item number	Wood	Height	Price
67202064100	Oak light oil, FSC Mix 70%	41 cm	900
67202244100	Oak black lacquer, FSC Mix 70%	41 cm	900
67202074100	Smoked oak, oiled, FSC Mix 70%	41 cm	1.030

Order configuration

Height: 35 or 41 cm.

Oak soap	Oak oiled	Oak light oil	Oak lacquered	Oak black lacquered	Smoked oak, oiled
990	900	900	1.060	900	1.030

Certifications

FSC® certified
EN 15372:2016 (L1)

Model 6725

Piloti Wood Coffee Table 63x63 cm



Designed by Hugo Passos, 2016

Legs and table top in solid hardwood. Legs mounted to table top with metal thread. Knock-down, delivered unassembled. Assembled without the use of screws and tools. Available in two heights, please specify 35 cm or 41 cm.

Modeldetails

0,05 m³ Packaging dimensions:
8,5 kg / 7,5 kg L: 70 cm W: 69 cm H: 10 cm

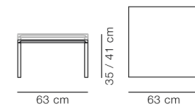

Essential Assortment

Pre-configured

Item number	Wood	Height	Price
67252063500	Oak light oil, FSC Mix 70%	35 cm	775
67252243500	Oak black lacquer, FSC Mix 70%	35 cm	775
67252073500	Smoked oak, oiled, FSC Mix 70%	35 cm	900

Order configuration

Height: 35 or 41 cm.

	Oak soap	Oak oiled	Oak light oil	Oak lacquered	Oak black lacquered	Smoked oak, oiled
	895	775	775	965	775	900

Certifications

FSC® certified
EN 15372:2016 (L1)

Model 6610

Piloti Alu table 75x39 cm



Designed by Hugo Passos, 2021

Coffee table with table top in stone or Fenix NTM laminate with a black core. Base in powder coated aluminium or brushed aluminium. Mounted with plastic glides, which can adjusted in height for uneven floors.

Modeldetails

0,06 m³ Packaging dimensions:
18 kg / 16,5 kg L: 83/87 cm W: 46/51 cm H: 9/5 cm

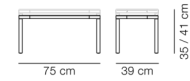

Essential Assortment

Pre-configured

Item number	Surface	Frame	Height	Price
66104584013505	Laminate Fenix NTM Black	Black lacquered aluminium	35 cm	1.000
66106059004105	White Carrara	Brushed aluminium	41 cm	1.780

Order configuration

Frame: Black or brushed aluminium.

Height: 35 or 41 cm.

	Fenix NTM laminate black	White Carrara	Black Marquina
Black	1.000	1.400	1.400
Brushed aluminium	1.305	1.780	1.780

Certifications

EN 15372:2016 (L3)

Model 6615

Piloti Alu table 120x39 cm



Designed by Hugo Passos, 2021

Coffee table with table top in stone or Fenix NTM laminate with a black core. Base in powder coated aluminium or brushed aluminium. Mounted with plastic glides, which can adjusted in height for uneven floors.

Modeldetails

0,08 m³ Packaging dimensions:
27,5 kg / 24 kg L: 127/132 cm W: 46/51 cm H: 8/5 cm

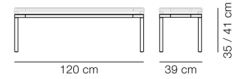

Essential Assortment

Pre-configured

Item number	Surface	Frame	Height	Price
66154584013505	Laminate Fenix NTM Black	Black lacquered aluminium	35 cm	1.180
66156059004105	White Carrara	Brushed aluminium	41 cm	2.015

Order configuration

Frame: Black or brushed aluminium.

Height: 35 or 41 cm.

	Fenix NTM laminate black	White Carrara	Black Marquina
Black	1.180	1.770	1.770
Brushed aluminium	1.540	2.015	2.015

Certifications

EN 15372:2016 (L3)

Model 6620

Piloti Alu table 75x75 cm



Designed by Hugo Passos, 2021

Coffee table with table top in stone or Fenix NTM laminate with a black core. Base in powder coated aluminium or brushed aluminium. Mounted with plastic glides, which can adjusted in height for uneven floors.

Modeldetails

0,09 m³ Packaging dimensions:
32 kg / 29,5 kg L: 82/87 cm W: 83/88 cm H: 8/5 cm

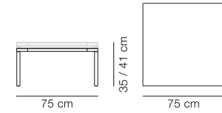

Essential Assortment

Pre-configured

Item number	Surface	Frame	Height	Price
66204584013505	Laminate Fenix NTM Black	Black lacquered aluminium	35 cm	1.180
66206059004105	White Carrara	Brushed aluminium	41 cm	2.015

Order configuration

Frame: Black or brushed aluminium.

Height: 35 or 41 cm.

	Fenix NTM laminate black	White Carrara	Black Marquina
Black	1.180	1.770	1.770
Brushed aluminium	1.540	2.015	2.015

Certifications

EN 15372:2016 (L3)

Model 1280

Pon Side Table Ø35 cm



Designed by Jasper Morrison, 2016

Side table in solid wood. Table top, column and base are joined with steel rods. The table can be disassembled for maintenance. Delivered assembled.

Modeldetails

0,06 m³ Packaging dimensions:
8,5 kg / 7,5 kg L: 39 cm W: 39 cm H: 40 cm

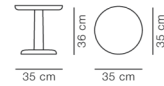

Essential Assortment

Pre-configured

Item number	Wood	Price
12802053600	Oak oil, FSC Mix 70%	675
12802063600	Oak light oil, FSC Mix 70%	675
12802073600	Smoked oak, oiled, FSC Mix 70%	735

Order configuration

Oak soap	Oak oiled	Oak light oil	Smoked oak, oiled	Oak lacquered	Oak black lacquered
675	675	675	735	780	780

Certifications

FSC® certified
EN 15372:2016 (L1)

Model 1285

Pon Side Table Ø40 cm



Designed by Jasper Morrison, 2016

Side table in solid wood. Table top, column and base are joined with steel rods. The table can be disassembled for maintenance. Delivered assembled.

Modeldetails

0,11 m³ Packaging dimensions:
9,6 kg / 8,4 kg L: 44 cm W: 44 cm H: 45 cm

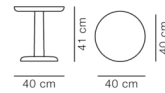

Essential Assortment

Pre-configured

Item number	Wood	Price
12852054100	Oak oil, FSC Mix 70%	710
12852064100	Oak light oil, FSC Mix 70%	710
12852074100	Smoked oak, oiled, FSC Mix 70%	775

Order configuration

Oak soap	Oak oiled	Oak light oil	Smoked oak, oiled	Oak lacquered	Oak black lacquered
710	710	710	775	855	855

Certifications

FSC® certified
EN 15372:2016 (L1)

Model 1290

Pon Side Table Ø45 cm



Designed by Jasper Morrison, 2016

Side table in solid wood. Table top, column and base are joined with steel rods. The table can be disassembled for maintenance. Delivered assembled.

Modeldetails

0,12 m³ Packaging dimensions:
7,9 kg / L: 49 cm W: 49 cm H: 50 cm
6,6 kg

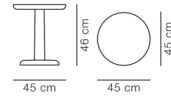

Essential Assortment

Pre-configured

Item number	Wood	Price
12902054600	Oak oil, FSC Mix 70%	775
12902064600	Oak light oil, FSC Mix 70%	775
12902074600	Smoked oak, oiled, FSC Mix 70%	900

Order configuration

	Oak soap	Oak oiled	Oak light oil	Smoked oak, oiled	Oak lacquered	Oak black lacquered
	775	775	775	900	1.005	1.005

Certifications

FSC® certified
EN 15372:2016 (L1)

Model 1295

Pon Coffee Table Ø90 cm



Designed by Jasper Morrison, 2016

Coffee table in solid wood. Table top, column and base are joined with steel rod. The table can be disassembled for maintenance. Knock-down, delivered unassembled.

Modeldetails

0,11 m³ Packaging dimensions:
25 kg / 20 kg L: 94 cm W: 105 cm H: 11 cm

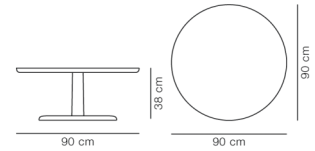

Essential Assortment

Pre-configured

Item number	Wood	Price
12952053800	Oak oil, FSC Mix 70%	2.210
12952063800	Oak light oil, FSC Mix 70%	2.210
12952073800	Smoked oak, oiled, FSC Mix 70%	2.540

Order configuration

	Oak soap	Oak oiled	Oak light oil	Smoked oak, oiled	Oak lacquered	Oak black lacquered
	2.210	2.210	2.210	2.540	2.640	2.640

Certifications

FSC® certified
EN 15372:2016 (L1)

Model 1960

Tableau Table Ø100 cm



Designed by Space Copenhagen, 2018

Fixed position coffee table made from Portuguese limestone. Table top of limestone, reinforced underside with fiber web. Base of intersecting limestone plates. The table must be assembled on site by professionals. Never sit or stand on your marble tabletop and avoid placing particularly heavy items on it.

Modeldetails

1,25 m³ Packaging dimensions:
123 kg / 78 kg L: 108 cm W: 26 cm H: 108 cm

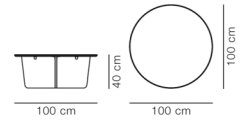

Essential Assortment

Pre-configured

Item number	Surface	Price
19606005064000	Dark Atlantico Limestone	3.555

Model 1966

Tableau Table 100x100 cm



Designed by Space Copenhagen, 2018

Fixed position coffee table made from Portuguese limestone. Table top of limestone, reinforced underside with fiber web. Base of intersecting limestone plates. The table must be assembled on site by professionals. Never sit or stand on your marble tabletop and avoid placing particularly heavy items on it.

Modeldetails

1,55 m³ Packaging dimensions:
128 kg / 83 kg L: 108 cm W: 26 cm H: 108 cm

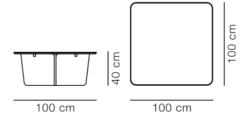

Essential Assortment

Pre-configured

Item number	Surface	Price
19666005074000	Dark Atlantico Limestone	3.555

Model 1965

Tableau Table 140x140 cm



Designed by Space Copenhagen, 2018

Fixed position coffee table made from Portuguese limestone. Table top of limestone, reinforced underside with fiber web. Base of intersecting limestone plates. The table must be assembled on site by professionals. Never sit or stand on your marble tabletop and avoid placing particularly heavy items on it.

Modeldetails

2 m³ Packaging dimensions:
260 kg / 152 kg L: 149 cm W: 26 cm H: 149 cm

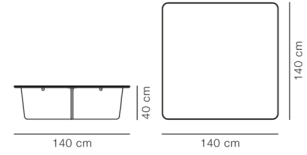

Essential Assortment

Pre-configured

Item number	Surface	Price
19656005044000	Dark Atlantico Limestone	5.765

Model 5104

ND104 Trisse Coffee Table Ø68 cm



Designed by Nanna Ditzel, 1962

Coffee table in solid wood. Table top, column and base are joined with steel rod.
Knock-down, delivered unassembled.

Modeldetails

0,04 m³ Packaging dimensions:
12,5 kg / L: 70 / 46 / 55 cm W: 70 / 10 / 55 cm
10,4 kg H: 4 / 10 / 5 cm

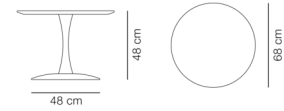

Essential Assortment

Pre-configured

Item number	Wood	Price
510424320500	Oak oil, FSC Mix 70%	915

Order configuration

	Oak soap	Oak oiled	Oak light oil	Smoked oak, oiled	Oak clear lacquered
	915	915	915	1.080	1.030

Certifications

FSC® certified
EN 15372:2023 (L3)

Model 5110

ND110 Trisse Coffee Table Ø55 cm



Designed by Nanna Ditzel, 1962

Coffee table in solid wood. Table top, column and base are joined with steel rod.
Knock-down, delivered unassembled.

Modeldetails

0,3 m³ Packaging dimensions:
8,1 kg / L: 60 / 46 / 55 cm W: 60 / 10 / 55 cm
6,1 kg H: 4 / 10 / 5 cm

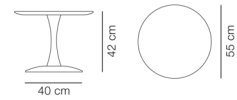

Essential Assortment

Pre-configured

Item number	Wood	Price
511024820500	Oak oil, FSC Mix 70%	835

Order configuration

	Oak soap	Oak oiled	Oak light oil	Smoked oak, oiled	Oak clear lacquered
	835	835	835	995	905

Certifications

FSC® certified
EN 15372:2023 (L3)

Model 5112

ND112 Trisse Coffee Table Ø75 cm



Designed by Nanna Ditzel, 1962

Coffee table in solid wood. Table top, column and base are joined with steel rod.
Knock-down, delivered unassembled.

Modeldetails

0,04 m³ Packaging dimensions:
13,5 kg / 11 kg L: 77 / 46 / 55 cm W: 77 / 10 / 55 cm
H: 4 / 10 / 5 cm

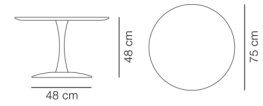

Essential Assortment

Pre-configured

Item number	Wood	Price
511224920500	Oak oil, FSC Mix 70%	955

Order configuration

	Oak soap	Oak oiled	Oak light oil	Smoked oak, oiled	Oak clear lacquered
	955	955	955	1.185	1.130

Certifications

FSC® certified
EN 15372:2023 (L3)

Model 5114

ND114 Trisse Coffee Table Ø90 cm



Designed by Nanna Ditzel, 1962

Coffee table in solid wood. Table top, column and base are joined with steel rod.
Knock-down, delivered unassembled.

Modeldetails

0,06 m³ Packaging dimensions:
16,7 kg / 14 kg L: 92 / 46 / 55 cm W: 92 / 12 / 55 cm
H: 4 / 12 / 5 cm

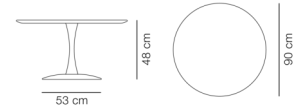

Essential Assortment

Pre-configured

Item number	Wood	Price
511425020500	Oak oil, FSC Mix 70%	1.270

Order configuration

	Oak soap	Oak oiled	Oak light oil	Smoked oak, oiled	Oak clear lacquered
	1.270	1.270	1.270	1.695	1.490

Certifications

FSC® certified

Model 1028

Wegner Ox Table Ø80 cm

Designed by Hans J. Wegner, 1960

Table top in veneer as per original designed construction. Core of furniture board. Edge in solid wood. Always mounted with plastic glides. Available in two heights, please specify height.



Modeldetails

0,05 m³ Packaging dimensions:
15 kg / 13,6 kg L: 83/51 cm W: 83/30 cm H: 6/6 cm

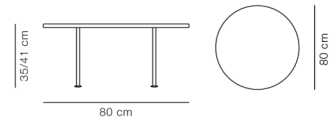

Essential Assortment

Pre-configured

Item number	Surface	Frame	Height	Price
10287056013500	Oak oil, FSC Mix 70%	Brushed stainless steel	35 cm	1.430
10287056014100	Oak oil, FSC Mix 70%	Brushed stainless steel	41 cm	1.430
10281646013500	Walnut oil	Brushed stainless steel	35 cm	2.005
10281646014100	Walnut oil	Brushed stainless steel	41 cm	2.005

Order configuration

Height: 35 or 41 cm.

	Oak lacquered	Oak oil	Walnut oil
Stainless steel, brushed	1.655	1.430	2.005

Certifications

Oak is FSC® certified

Model 1020

Wegner Ox Table Ø100 cm



Designed by Hans J. Wegner, 1960

Table top in veneer as per original designed construction. Core of MDF. Edge in solid wood. Always mounted with plastic glides. Available in two heights, please specify height.

Modeldetails

0,07 m³ Packaging dimensions:
20 kg / 18,6 kg L: 103/51 cm W: 103/30 cm H: 6/6 cm

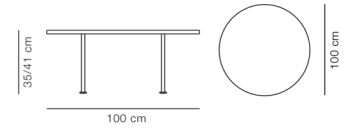

Essential Assortment

Pre-configured

Item number	Surface	Frame	Height	Price
10207056013500	Oak oil, FSC Mix 70%	Brushed stainless steel	35 cm	2.005
10207056014100	Oak oil, FSC Mix 70%	Brushed stainless steel	41 cm	2.005

Order configuration

Height: 35 or 41 cm.

	Oak lacquered	Oak oil
Stainless steel, brushed	2.100	2.005

Certifications

Oak is FSC® certified

Model 1022

Wegner Ox Table Ø120 cm



Designed by Hans J. Wegner, 1960

Table top in veneer as per original designed construction. Core of MDF. Edge in solid wood. Always mounted with plastic glides. Available in two heights, please specify height.

Modeldetails

0,1 m³ Packaging dimensions:
28 kg / 24,6 kg L: 123/51 cm W: 123/51 cm H: 6/6 cm

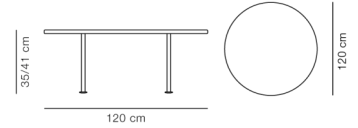

Essential Assortment

Pre-configured

Item number	Surface	Frame	Height	Price
10227056013500	Oak oil, FSC Mix 70%	Brushed stainless steel	35 cm	2.290
10227056014100	Oak oil, FSC Mix 70%	Brushed stainless steel	41 cm	2.290
10221646013500	Walnut oil	Brushed stainless steel	35 cm	2.580
10221646014100	Walnut oil	Brushed stainless steel	41 cm	2.580

Order configuration

Height: 35 or 41 cm.

	Oak lacquered	Oak oil	Walnut oil
Stainless steel, brushed	2.420	2.290	2.580

Certifications

Oak is FSC® certified

Model 1025

Wegner Ox Table Ø150 cm



Designed by Hans J. Wegner, 1960

Table top in veneer as per original designed construction. Core of MDF. Edge in solid wood. Always mounted with plastic glides. Available in two heights, please specify height.

Modeldetails

0,15 m³ Packaging dimensions:
39 kg / 35,6 kg L: 153/51 cm W: 153/51 cm H: 6/6 cm

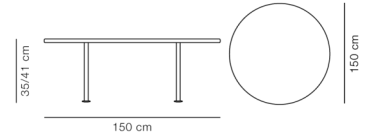

Essential Assortment

Pre-configured

Item number	Surface	Frame	Height	Price
10251056013500	Oak oil	Brushed stainless steel	35 cm	3.930
10251056014100	Oak oil	Brushed stainless steel	41 cm	3.930
10251646013500	Walnut oil	Brushed stainless steel	35 cm	4.305
10251646014100	Walnut oil	Brushed stainless steel	41 cm	4.305

Order configuration

Height: 35 or 41 cm.

	Oak lacquered	Oak oil	Walnut oil
Stainless steel, brushed	4.075	3.930	4.305

Storage

Model 2921



BM29 Shelf

1 compartment, 2 shelves

Designed by Børge Mogensen, 1956

Rails and brackets are solid wood while the shelves are veneer. The shelves are mounted on the rails and brackets using screws. The rails are mounted to the wall with the keyhole fittings and screws. Brass screws for mounting of shelves to rails and to the wall is included. Rawlplugs is not included as it depends on the specific type of wall.

Modeldetails

0,02 m³ Packaging dimensions:
9 kg / 7 kg L: 81 cm W: 27 cm H: 8 cm

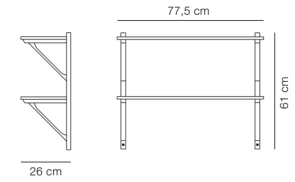

Essential Assortment

Pre-configured

Item number	Surface	Price
29215129310400	Oak clear lacquer	1.085
29215129316200	Walnut lacquer	1.205

Max load capacity for the shelf is 10 kg per shelf, where the composition of the wall and the mounting of the module allow this. The weight should be distributed evenly.

Model 2901



BM29 Shelf

1 compartment, 3 shelves & desk shelf

Designed by Børge Mogensen, 1956

Rails and brackets are solid wood while the shelves are veneer. The shelves are mounted on the rails and brackets using screws. The rails are mounted to the wall with the keyhole fittings and screws. Brass screws for mounting of shelves to rails and to the wall is included. Raw/plugs is not included as it depends on the specific type of wall.

Modeldetails

0,07 m³ Packaging dimensions:
16 kg / L: 137 cm W: 45 cm H: 11 cm
14 kg

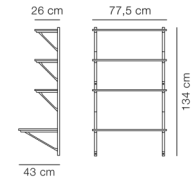

Essential Assortment

Pre-configured

Item number	Surface	Price
29015329110400	Oak clear lacquer	2.050
29015329116200	Walnut lacquer	2.410

Max load capacity for the shelf is 10 kg per shelf, where the composition of the wall and the mounting of the module allow this. The weight should be distributed evenly.

Model 2920

BM29 Shelf 2 compartments, 2 shelves



Designed by Børge Mogensen, 1956

Rails and brackets are solid wood while the shelves are veneer. The shelves are mounted on the rails and brackets using screws. The rails are mounted to the wall with the keyhole fittings and screws. Brass screws for mounting of shelves to rails and to the wall is included. Rawplugs is not included as it depends on the specific type of wall.

Modeldetails

0,05 m³ Packaging dimensions:
13 kg / 11 kg L: 156 cm W: 28 cm H: 11 cm

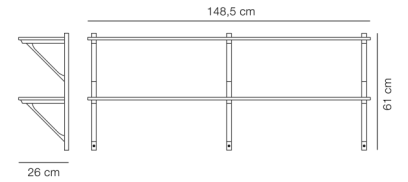

Essential Assortment

Pre-configured

Item number	Surface	Price
29205229210400	Oak clear lacquer	1.685
29205229216200	Walnut lacquer	1.930

Max load capacity for the long shelves is 15 kg per shelf where the composition on the wall and the mounting of the module allow this. The weight should be distributed evenly.

Model 2900



BM29 Shelf

2 compartments, 3 shelves, desk shelf

Designed by Børge Mogensen, 1956

Rails and brackets are solid wood while the shelves are veneer. The shelves are mounted on the rails and brackets using screws. The rails are mounted to the wall with the keyhole fittings and screws. Brass screws for mounting of shelves to rails and to the wall is included. Rawplugs is not included as it depends on the specific type of wall.

Modeldetails

0,1 m³ Packaging dimensions:
26 kg / 24 kg L: 156 cm W: 45 cm H: 14 cm

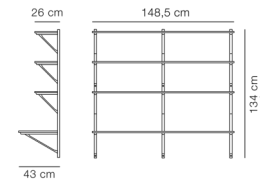

Essential Assortment

Pre-configured

Item number	Surface	Price
29005429010400	Oak clear lacquer	3.015
29005429016200	Walnut lacquer	3.375

Max load capacity is 15 kg per long shelf where the composition of the wall and the mounting of the module allow this. The weight should be distributed evenly.

Complements

Model 5375

BM375 Nesting Tables



Designed by Børge Mogensen, 1962

Side table with base in solid wood and table top in veneer made with box-joints. A nest consists of 3 tables.

Modeldetails

0,13 m³ Packaging dimensions:
13 kg / 11 kg L: 50 cm W: 50 cm H: 52 cm

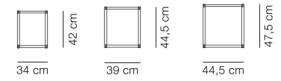

Essential Assortment

Pre-configured

Item number	Wood	Description	Price
53752060337500	Oak light oil, FSC Mix 70%	Set of 3	960

Certifications

FSC® certified
EN 15372:2016 (L2)

Model 1610

Gallery Stool



Designed by Hans Sandgren Jakobsen, 1998

Stool made from a single mould of plywood and fixed with metal joints.

Modeldetails

0,12 m³ Packaging dimensions:
6,1 kg / 4 kg L: 56 cm W: 41 cm H: 54 cm

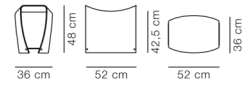

Essential Assortment

Pre-configured

Item number	Wood	Price
1610223	Black ash, FSC Mix 70%	820
1610226	Walnut lacquer, FSC Mix 70%	820

Certifications

FSC® certified

Model 6565

JG Stool



Designed by Jørgen Gammelgaard, 1970

Folding stool with base in stainless steel with seat in leather or 100% linen canvas.
Leather seat has canvas backing. No glides available.

Modeldetails

0,02 m³ Packaging dimensions:
6,2 kg / 5,6 kg L: 76 cm W: 48 cm H: 6 cm

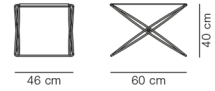

Essential Assortment

Pre-configured

Item number	Seat	Frame	Price
65653160100	Natural canvas	Brushed stainless steel	745
65653460100	Leather Max 98, Black	Brushed stainless steel	990
65653560100	Leather Vegeta, Natural	Brushed stainless steel	990
65653360100	Leather Max 95, Cognac	Brushed stainless steel	1.025

Certifications

EN 1022:2005, EN 16139:2013 (L1)

Model 6500

Magazine Table Side table



Designed by Jens Risom, 1949

Side table. Base and table top in plywood.

Modeldetails

0,14 m³ Packaging dimensions:
6,1 kg / 4,6 kg L: 61 cm W: 44 cm H: 52 cm



Essential Assortment

Pre-configured

Item number	Wood	Price
650020200	Oak lacquer, FSC Mix 70%	560
650022500	Oak black lacquer, FSC Mix 70%	560

Certifications

FSC® certified

Model 5009



ND09 Coat stand

Designed by Nanna Ditzel, 1963

Coat rack in solid wood. Top, column and base are joined with steel rod. Knock-down, delivered unassembled.

Modeldetails

0,25 m³ Packaging dimensions:
 9,8 kg / 7,3 kg L: 71 / 104 / 55 cm W: 71 / 12 / 55 cm H: 43 / 12 / 5 cm

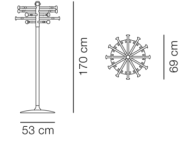

Essential Assortment

Pre-configured

Item number	Wood	Price
500962310500	Oak oil	1.330

Order configuration

	Oak soap	Oak oiled	Oak light oil	Oak clear lacquered	Oak black lacquered
	1.330	1.330	1.330	1.610	1.720

Model 6830

Pioneer Stool, ht 46 cm



Designed by Maria Bruun, 2023

Stackable stool with a base in solid wood. Seat consists of an inner construction of a MDF core with moulded polyurethane foam, either HR or CMHR foam and upholstered with a removable fabric cover with zippers or non-removable cover in leather. Upholstered seat is removable. Metal screws and fittings. Mounted with plastic glides, felt glides are available.

Modeldetails

0,09 m³ Packaging dimensions:
5,5 kg / 3,5 kg L: 42 cm W: 42 cm H: 50 cm

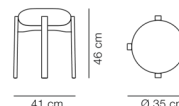

Essential Assortment

Pre-configured

Item number	Upholstery	Frame	Price
6830448550894400	Odino RC41	Beech Dark Brown, FSC Mix 70%	530
6830448560897400	Odino NE22	Beech oiled, FSC Mix 70%	530
6830448580898400	Odino RC43	Beech Bordeaux, FSC Mix 70%	530
6830448540854400	Odino PV82	Oak lacquer, FSC Mix 70%	650
6830002070854400	Hallingdal 200	Oak lacquer, FSC Mix 70%	690
6830508610855400	Leather Primo 86-1, Dark brown	Smoked oak stained lacquer, FSC Mix 70%	795
6830500900854400	Leather Vegeta 90, Natural	Oak lacquer, FSC Mix 70%	800

Essential variants are delivered with plastic glides and HR foam

Order configuration

Fabric group 0: Odino fabric

	Beech: black lacquered, Dark brown lacquered, Bordeaux, Oiled	Oak lacquered	Smoked oak stained, lacquered
Fabric group 0	530	650	705
Fabric group 1	590	650	705
Fabric group 2	630	690	750
Fabric group 3	660	720	775
Fabric group 4	705	770	825
Fabric group 5	800	865	920
C.O.M. fabric	600	660	720
Leather group 1	640	700	755
Leather group 2	675	740	795
Leather group 3	685	745	795
Leather group 4	735	800	850
Leather group 5	830	895	950
C.O.M. leather	650	715	770

Fabric consumption: 0,5 m. Leather consumption: 0,5 m²

Stackable: 6 pcs. on floor.

Certifications

FSC® certified

EN 1022:2005, EN 16139:2013 (L2)

Recommended upholstery

Fabric group 1	Re-wool, Capture, Bardal, Linara, Erik
Fabric group 2	Steelcut Trio, Hallingdal, Barnum, Fiord, Loop, Ruskin
Fabric group 3	Divina Melange, Vidar, Sunniva, Clay, Zero
Fabric group 4	Elle, Safire
Fabric group 5	Gentle
Leather group 1	Omni
Leather group 2	Primo, Trace
Leather group 3	Max
Leather group 4	Nubuck, Vegeta, Organic

Model 6402

Seto Stool



Designed by Keiji Takeuchi, 2023

Base in solid wood mounted with a non-removable seat in canvas finished with a leather cord. Glides in felt are included.

Modeldetails

0,09 m³ Packaging dimensions:
6 kg / L: 55 cm W: 37 cm H: 45 cm
5,2 kg

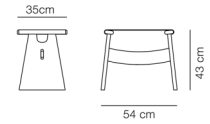

Essential Assortment

Pre-configured

Item number	Seat	Frame	Price
64023085337	Black canvas	Oak black lacquer, FSC Mix 70%	720
64023185237	Natural canvas	Oak light oil - FSC Mix 70%	720

Certifications

FSC® certified
EN 1022:2005, EN 16139:2013 (L1)

Model 1756

Sequoia Pouf Ø40 cm



Designed by Space Copenhagen, 2020

Fully upholstered pouf with Inner shell in moulded polyurethane foam, either HR or CMHR foam, reinforced with a steel frame and wooden base.
Upholstered in textile and mounted with plastic gliders, felt glides are available.

Modeldetails

0,1 m³ Packaging dimensions:
8 kg / 6 kg L: 45 cm W: 45 cm H: 47 cm

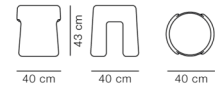

Essential Assortment

Pre-configured

Item number	Upholstery	Price
175600481046	Barnum 24, Lana	935
175600205046	Hallingdal 110	935
175649980046	Sheepskin Moonlight	1.250

Essential variants only delivered with HR foam

Order configuration

Fabric group 1	810
Fabric group 2	935
Fabric group 3	980
Fabric group 4	1.070
Fabric group 5	1.185
C.O.M. fabric	885
Leather group 0	910
Leather group 1	965
Leather group 2	1.060
Leather group 3	1.120
Leather group 4	1.210
Leather group 5	1.390
C.O.M. leather	965
Sheepskin	1.250

Fabric consumption: 1,1 m

Recommended upholstery

Fabric group 1	Gran Linen, Natural Linen, Erik, Remix, Capture, Bardal, Re-wool, Linara
Fabric group 2	Hallingdal, Barnum, Loop, Steelcut Trio, Fiord, Ruskin
Fabric group 3	Divina Melange, Vidar, Sunniva, Clay
Fabric group 4	Elle, Safire, Sisù
Fabric group 5	Gentle
Leather group 0	Vice
Leather group 1	Omni
Leather group 2	Primo, Trace
Leather group 3	Max
Leather group 4	Nubuck, Vegeta, Organic

Model 8321

Silhouette Mirror Ø55 cm



Designed by OEO Studio, 2020

Mirror with frame in solid wood. 4 mm mirror glass. Back of black lacquered MDF. Wall suspension fittings of birch plywood included. Screws and rawplugs for mounting not included. Caution: as solid wood reacts to damp or dry air, the mirror should not be placed in extreme indoor climate conditions.

Modeldetails

0,029 m³ Packaging dimensions:
7 kg / L: 69 cm W: 70 cm H: 6 cm
3,8 kg

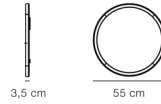

Essential Assortment

Pre-configured

Item number	Frame	Price
832113	Oak light oil	600
832111	Walnut oil	720

Model 8320

Silhouette Mirror Ø100 cm

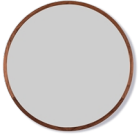

Designed by OEO Studio, 2020

Mirror with frame in solid wood. 4 mm mirror glass. Back of black lacquered MDF. Wall suspension fittings of birch plywood included. Screws and rawplugs for mounting not included. Caution: as solid wood reacts to damp or dry air, the mirror should not be placed in extreme indoor climate conditions.

Modeldetails

0,08 m³ Packaging dimensions:
20 kg / 12 kg L: 114 cm W: 116 cm H: 6 cm

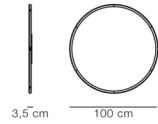

Essential Assortment

Pre-configured

Item number	Frame	Price
832013	Oak light oil	1.085
832011	Walnut oil	1.205

Model 8322

Silhouette Mirror 70x70 cm



Designed by OEO Studio, 2020

Mirror with frame in solid wood. 4 mm mirror glass. Back of black lacquered MDF. Wall suspension fittings of birch plywood included. Screws and rawlplugs for mounting not included. Caution: as solid wood reacts to damp or dry air, the mirror should not be placed in extreme indoor climate conditions.

Modeldetails

0,04 m³ Packaging dimensions:
11 kg / 7 kg L: 82 cm W: 80 cm H: 6 cm

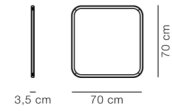

Essential Assortment

Pre-configured

Item number	Frame	Price
832213	Oak light oil	900
832211	Walnut oil	1.025

Model 8324



Silhouette Mirror 70x180 cm

Designed by OEO Studio, 2020

Mirror with frame in solid wood. 4 mm mirror glass. Back of black lacquered MDF. Wall suspension fittings of birch plywood included. Screws and rawlplugs for mounting not included. Caution: as solid wood reacts to damp or dry air, the mirror should not be placed in extreme indoor climate conditions.

Modeldetails

0,09 m³ Packaging dimensions:
30 kg / 16 kg L: 191 cm W: 83 cm H: 7 cm

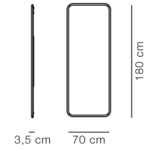

Essential Assortment

Pre-configured

Item number	Frame	Price
832413	Oak light oil	1.445
832411	Walnut oil	1.565

Model 8201

Orb Vase Height 20 cm



Designed by Tadaima, 2025

Mouthblown vase made from crystal glass with visible soda bubbles.

Modeldetails

0,02 m³ Packaging dimensions:
3,8 kg / L: 28 cm W: 28 cm H: 28 cm
3,3 kg



Essential Assortment

Pre-configured

Item number	Material	Price
820140	Glass	210

Model 8202



Conical Vase Height 30 cm

Designed by Tadaima, 2025

Mouthblown vase made from crystal glass with visible soda bubbles.

Modeldetails

0,03 m³ Packaging dimensions:
4,6 kg / L: 26 cm W: 26 cm H: 37 cm
3,9 kg

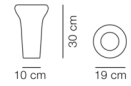

Essential Assortment

Pre-configured

Item number	Material	Price
820240	Glass	220

Model 8203



Conical Vase Height 40 cm

Designed by Tadaima, 2025

Mouthblown vase made from crystal glass with visible soda bubbles.

Modeldetails

0,05 m³ Packaging dimensions:
6,4 kg / L: 32 cm W: 32 cm H: 48 cm
5,3 kg

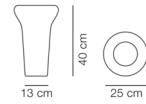

Essential Assortment

Pre-configured

Item number	Material	Price
820340	Glass	340

Model 8230



Grid Throw 140x180 cm

Designed by Tadaima, 2025

Throw in jacquard-woven fabric made from 54% cotton, 23% acrylic, 11% Mohair, 9% Virgin Wool, 3% Alpaca Wool.

Modeldetails

0,06 m³ Packaging dimensions:
1,6 kg / L: 56 cm W: 46 cm H: 19 cm
1,4 kg

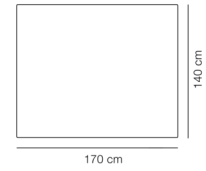

Essential Assortment

Pre-configured

Item number	Colour	Price
823070906	Dark Grey tone in tone	350
823070907	Off-white tone in tone	350
823070908	Black tone in tone	350

Price per unit.
Sold in set of 3pcs in same colour.

Model 8240

Grid Decorative Cushion 40x60 cm



Designed by Tadaima, 2025

Decorative cushion with filling made of 100% Danish duck feathers. Removable cover in jacquard-woven fabric made of 54% cotton, 23% acrylic, 11% mohair, 9% virgin wool, 3% alpaca wool.

Modeldetails

0,09 m³ Packaging dimensions:
1,3 kg / L: 37 cm W: 37 cm H: 52 cm
1,1 kg

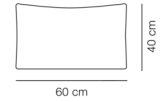

Essential Assortment

Pre-configured

Item number	Colour	Price
8240710060	Dark Grey tone in tone	140
8240710070	Off-white tone in tone	140
8240710080	Black tone in tone	140

Price per unit.
Sold in set of 3pcs in same colour.

Model 5102

ND102 Trisse Stool Ø32 cm



Designed by Nanna Ditzel, 1962

Stool in solid wood. Top, column and base are joined with steel rod.

Modeldetails

0,04 m³ Packaging dimensions:
3,8 kg / L: 35 cm W: 35 cm H: 30 cm
2,3 kg

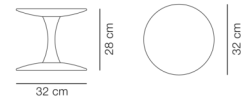

Essential Assortment

Pre-configured

Item number	Wood	Price
510224020500	Oak oil, FSC Mix 70%	405

Order configuration

	Oak soap	Oak oiled	Oak light oil	Smoked oak, oiled	Oak clear lacquered	Oak black lacquered
	405	405	405	510	450	450

Certifications

FSC® certified
EN 16139:2025 (L1), EN 1022:2023

Model 5105

ND105 Trisse Stool Ø40 cm



Designed by Nanna Ditzel, 1962

Stool in solid wood. Top, column and base are joined with steel rod. Mounted with felt glides.

Modeldetails

0,09 m³ Packaging dimensions:
6,2 kg / 4,4 kg L: 43 cm W: 43 cm H: 48 cm

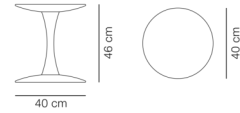

Essential Assortment

Pre-configured

Item number	Wood	Price
510530020579	Oak oil, FSC Mix 70%	520

Order configuration

	Oak soap	Oak oiled	Oak light oil	Smoked oak, oiled	Oak clear lacquered	Oak black lacquered
	520	520	520	765	565	565

Certifications

FSC® certified
EN 16139:2025 (L1), EN 1022:2023

Model F1090

Fredericia Care Kits



Designed by Fredericia Furniture

All Fredericia Care Kits are packaged in a brown cardboard box and includes necessary cloths or sponges for one treatment. Instructions are enclosed and can also be downloaded through fredericia.com.

Order configuration

	Wood oil	Wood light oil	Wood soap	Leather Care Lotion, single bottle	Leather Care Kit
	30	30	30	25	60

Only for sale in Europe.

Material Samples

All prices are excl. VAT and shipping costs

PRODUCT	SIZE	PRICE EUR
Sample kits		
Sample Box, full collection	275 x 315 x 110 mm	429
Sample Organizer, small	260 x 315 x 70 mm	221
Wall mounted hook for chairs, Oak lacquered		25
Fredericia logo block, black ash & white logo	25m x 83 mm	40
Leather sets		
Leather card	A4 fold-out	22
Saddle leather, set of 3 pcs	70 x 150 mm	15
Leather Hanger, Gr. 0+1	A5	67
Leather Hanger, Gr. 2	A5	67
Leather Hanger, Gr. 3	A5	98
Leather Hanger, Gr. 3+4	A5	98
Leather, single samples		
A5, Leather Gr. 0-2	A5	6
A5, Leather Gr. 3-4	A5	9
75x55mm, Leather Gr. 0-2	75x55mm	4
75x55mm Leather Gr. 3-4	75x55mm	4
Saddle leather	75x55mm	4
Sheepskin	75x55mm	4
Fabric, single samples		
Texture sample, standard fabrics*	75x55mm	3
Canvas & Linen webbing	75x55mm	2
Wood		
Wood Retail Display w. 10x10cm solid wood samples	360x130x60mm	280
Single wood sample, small	75x55mm	7
Single wood sample, large	100x100mm	11
Metal	75x55mm	4
Laminates / linoleum	75x55mm	5
Stone		
Stone Retail Display w. 10x10cm solid stone samples	360x130x60mm	251
Single graphic stone sample, small	75x55mm	4
Single solid stone sample, large	100x100mm	22
Pato Colours		
Pato Colour reference	75x55mm	4
Pato Polypropylene	60x100mm	5

*Available in one colour only

For other material & surface samples, please contact Customer Care & Quality at customerservice@fredericia.com

Fredericia Furniture A/S

Treldevej 183
7000 Fredericia

info@fredericia.com
+45 7592 3344



fredericia.com