

Recommended Prices

Ex. VAT - EUR - January 2025

Version 25.1



Fredericia





Content

Visual index	04
Material information	10
Fredericia Standard Fabrics	12
Textile supplier overview	13
Fredericia Leather	14
Leather supplier overview	15
Customer Care & C.O.M. upholstery	16
Table size seating overview	17
Terms & Conditions of Sale and Delivery	19
Pricelist	
Chairs & stools	23
Lounge chairs	105
Sofas	153
Tables	239
Coffee & Side Tables	281
Storage	315
Complements	321
Material Samples & Care Kits	341











Chairs & Stools

COLLECTION	PAGE
BM61 & BM62 Borge Mogensen	24
Eyes Johannes Foersom & Peter Hiort-Lorenzen	28
Flamingo Johannes Foersom & Peter Hiort-Lorenzen	33
J39 Mogensen Chair Borge Mogensen	34
Klint Chair Kaare Klint	36
Lynderup Chair Borge Mogensen	38
Mogensen Bench & Chair Borge Mogensen	43
Pato 4 Leg Welling/Ludvik	45
Pato Wood Base Welling/Ludvik	49
Pato Sledge Welling/Ludvik	51
Pato Swivel & Office Welling/Ludvik	58
Pato Executive Welling/Ludvik	62
Pioneer Maria Bruun	67
Plan Armchair Edward Barber & Jay Osgerby	69
Plan Chair Edward Barber & Jay Osgerby	71
Post Cecilie Manz	77
The Spanish Dining Chair Borge Mogense	79
Soborg Borge Mogensen	82

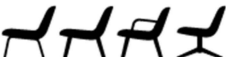







Chairs & Stools

COLLECTION		PAGE
Spine Wood Base Space Copenhagen		89
Swoon Dining Space Copenhagen		92
Trinidad Nanna Ditzel		94
Yksi Thau & Kallio		103

Lounge Chairs

COLLECTION		PAGE
A-Chair Jens Risom		106
Canvas 21 Chair Børge Mogensen		108
The Canvas Chair Børge Mogensen		110
Corona Chair Poul M. Volther		113
Ditzel Lounge Nanna Ditzel		115
Eyes Lounge Johannes Foersom & Peter Hiort-Lorenzen		117
Gomo Lounge Hugo Passos		121
The Hunting Chair Børge Mogensen		123
Jota Lounge Chair Jasper Morrison		125
Mogensen 22 Collection Børge Mogensen		127
Mono Birgitte Due Madsen & Jonas Trampedach		130
Pato Lounge Welling/Ludvik		132

Lounge Chairs

COLLECTION		PAGE
Savannah Monica Förster		133
The Spanish Chair Børge Mogensen		135
Spine Lounge Space Copenhagen		137
Swoon Lounge Space Copenhagen		139
Wegner 1788 Lounge Chair Hans J. Wegner		143
Wegner J16 Rocking Chair Hans J. Wegner		145
Wegner Ox Chair Hans J. Wegner		149
Wegner Queen Chair Hans J. Wegner		151







Sofas

COLLECTION		PAGE
Calmo Hugo Passos		154
Delphi Hannes Wettstein		169
EJ220 Erik Jørgensen	 ERIK JØRGENSEN	187
EJ280 Erik Jørgensen Studio	 ERIK JØRGENSEN	191
EJ315 Erik Ole Jørgensen		204
Gomo Sofa Hugo Passos		207
JG Sofa Jørgen Gammelgaard		209
Jota Sofa Jasper Morrison		211



Sofas

COLLECTION		PAGE
Konami Damian Williamson		214
Mogensen 22 Collection Børge Mogensen		218
Mogensen 23 Collection Børge Mogensen		224
Nami Damian Williamson		226
No.1 Børge Mogensen		230
Savannah Monica Förster		232
Spine Space Copenhagen		234
The Spoke-Back Sofa Børge Mogensen		235









Tables

COLLECTION		PAGE
Ana Table Arde		240
BM71 Library Table Børge Mogensen		242
Mogensen Dining Tables Børge Mogensen		243
Islets Maria Bruun		253
JG Table Jørgen Gammelgaard		254
Plan Table Edward Barber & Jay Osgerby		256
Plan Table, Column Edward Barber & Jay Osgerby		272

Tables

COLLECTION		PAGE
Post Cecilie Manz		275
Taro Jasper Morrison		279



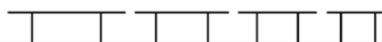







Coffee & Side Tables

COLLECTION		PAGE
BM67 Coffee Table Børge Mogensen		282
Insula Anne-Mette Bartholin Jensen & Morten Ernst		283
Islets Maria Bruun		287
JG Coffee Table Jørgen Gammelgaard		289
Niveau Cecilie Manz		290
Pal Keiji Takeuchi		293
Piloti Hugo Passos		295
Pon Jasper Morrison		304
Tableau Space Copenhagen		308
Wegner Ox Table Hans J. Wegner		311

Storage

COLLECTION		PAGE
BM29 Shelf Børge Mogensen		316

Complements

COLLECTION		PAGE
BM Nesting Tables Børge Mogensen		322
Fellow & Meadow Space Copenhagen		323
Gallery Hans Sandgren Jakobsen		325
Hydro & Locus Sofie Østerby		326
JG Folding Stool Jorgen Gammelgaard		331
Magazine Table Jens Risom		332
Nara Shin Azumi		333
Pioneer Maria Bruun		334
Seto Stool Keiji Takeuchi		335
Sequoia Space Copenhagen		336
Silhouette OEO Studio		337

Wood surfaces

Material and surface may refer to both solid wood and outer layer on plywood or veneered table tops. Oak, ash and beech are sourced from sustainably managed European forests. Walnut is American walnut. Not all products are available in all materials.



FSC® Licence number
FSC C151292

WOOD	FINISH	DESCRIPTION
Oak	Oak soap	Treated with natural soap flakes. Light colour gets patina and darkens over time
	Oak lacquered	Clear lacquer, slightly white pigmented
	Oak oil	Clear natural oil with darkening effect on the natural colour tone of oak
	Oak light oil	Clear natural oil slightly pigmented, preserving the natural light colour tone of oak.
	Smoked oak, oiled	Fumed oak with clear natural oil treatment. Brown colour tone where large colour differences occur between wooden parts. The dark colour lightens with sunlight.
	Smoked oak stained, lacquered	Stained in smoked oak colour and finished with matt lacquer. The natural surface of the wood is visible through the stain.
	Grey oak stained, lacquered / Light grey oak stained, lacquered	Stained in a dark grey/ light grey shade and finished with matt lacquer. The natural surface of the wood is visible through the stain.
	Oak black lacquered	Finished with black lacquer preserving wooden grain structure.
Ash	Oak white painted	Painted white preserving wooden grain structure.
	Ash oil	Clear natural oil with darkening effect on the natural colour tone of oak.
	Ash brown stained	Stained in dark colour. The natural surface of the wood is visible through the stain.
	White ash	Painted white preserving wooden grain structure
Beech	Black ash	Finished with black lacquer preserving wooden grain structure
	Beech soap	Treated with natural soap flakes, light colour gets patina and darkens over time.
	Beech lacquered	Clear lacquer
	Beech vintage lacquered	Finished with a slightly brown pigmented lacquer, darkening the surface of the wood.
	Beech standard lacquered colours	Finished with a coloured lacquer which limits the visibility of the wooden grain structure. Only available for Trinidad and J39. The specific colours can be seen under each product.
	Beech Black lacquered	Finished with black lacquer limiting the visibility of the wooden grain structure
Walnut	Beech white painted	Painted white, limiting the visibility of the wooden grain structure
	Walnut lacquered	Clear lacquer with UV protection
	Walnut oiled	Clear natural oil
Oregon Pine	Oregon Pine lacquered	Finished with a slightly brown pigmented lacquer, darkening the surface of the wood.

Laminate & linoleum

Not all models are available in all colours. Customised finishes are available, subject to quotation.

MATERIAL	COLOUR CODE	ANA	JG TABLE	PLAN TABLE
Fenix NTM laminate, white	Fenix 0032	•		
Fenix NTM laminate, black	Fenix 0720	•		•
Fenix NTM laminate, almond	Fenix 0717	•		
Linoleum, black			•	•
Linoleum, grey			•	
Really, Cotton Cream				•

For a visual overview of all our materials please see our material and surface catalogue *Fredericia Colour World* at fredericia.com

Material information

Standard Colours

The Standard Colours are applied to coloured-through recycled polypropylene (PP) and certain woods, as well as powder coats. Customised colours are available for an extra charge. Customer approval of the test is required before production start-up.

COLOUR NAME	COLOUR CODE	J39 MOGENSEN CHAIR	TRINIDAD	PLAN CHAIR & TABLE	PATO
Black	RAL 9005	•	•	•	•
White	RAL 9016	•			•
Dark grey	NCS S 8000 N				•
Stone	NCS S 3502 B				•
Sand	NCS S 2005 Y30R				•
Quartz grey	RAL 7039				•
Storm	NCS S 5020 R90B				•
Ancient green	NCS S 8010 B50G				•
Ocean	NCS S 3010 B90G				•
Dark red	NCS S 5540 Y90R				•
Modernist green	NCS S 5020-G30Y			•	
Bordeaux	NCS S 7020-R10B			•	
Heritage red	NCS S 4550-Y60R	•			
Indigo blue	RAL 5011	•			
Khaki green	NCS S 7010-G70Y	•	•		
Pebble grey	NCS S 3005-Y50R	•			
Nordic blue	NCS S 3005-Y50R		•		

Metal Surfaces

Not all models are available in all colours. Customised finishes are available, subject to quotation.

NAME	DESCRIPTION
Brushed stainless steel	Stainless steel, brushed finish. Appearance match other brushed finishes.
Brushed chrome	Brushed, then chromed steel. Appearance match other brushed finishes.
Brushed aluminium	Aluminium with brushed finish. Appearance match other brushed finishes.
Chrome	Chrome plated (chrom III), occasionally in combination with polished aluminium.
Polished aluminium	Shiny polished aluminium. Appearance match chrome finish.
Matt chrome	Chrome plated (Chrom III), satin chromed.
Black	Powder coated RAL 9005.
Flint	Powder coating with metallic effect, gunmetal colour.

Stone

Marble and limestone are natural materials where two surfaces are never alike. The stones can contain sediments from fossils, sand holes, glass veins and porosity and all are indicators of genuine stone while attributing to the natural character of the surface. By quotation all stone can be delivered with polyester coating which seals the surface. Not all models are available in all surfaces. Marble is not flexible and won't respond well to heavy loading. Never sit or stand on your marble tabletop and avoid placing particularly heavy items on it. Max load is 20 kgs.

NAME	DESCRIPTION
Grey Pietra Marble	Grey Pietra is a marble with a matt, grey surface with natural, irregular flecks of white. The grey colour of the background can appear uniform but the nuances of grey can vary. The fine white streaks and slightly darker grey glazes give the surface an animated and elegant look. Grey Pietra is sourced from Turkey.
Black Marquina Marble	Black Marquina is an elegant marble with a matt, black surface with natural strong white veins. The intense marble takes its name from the quarries around the town of Marquina from which it is extracted. The irregular white veins can vary considerably from batch to batch. Black Marquina is sourced from Spain.

Fredericia Standard Fabrics

White Carrara Marble	White Carrara is a classic white marble with a matt surface, characterised by the occurrence of natural and irregular grey veins. White Carrara has been used for centuries by architects, designers and artists alike. The white surface can vary in tone and the occurrence of grey to almost black veins can likewise vary in quantity and strength. White Carrara is sourced from Italy.
Dark Atlantico Limestone	Dark Atlantico is a limestone with a beautiful natural surface and warm colour tones in umbra grey shades. Possible aspects of fossils and sediments. Large colour differences to be expected. Extremely sensitive to acids, which can leave non-removable marks. Dark Atlantico is sourced from Portugal.
Ivory Quartzite	Ivory Quartzite is a light and elegant stone with a matt ivory surface. The nuances can vary including the possibility of both light and darker veining. Resistant to acids and scratching. Ivory Quartzite is sourced from Brazil.
Tundra Grey Marble	Tundra Grey Marble is an exquisite natural stone with a unique blend of cloud-like grey hues and pearl tones. Its intricate veining patterns create a mesmerizing visual effect with a fine-grained surface which is smooth to the touch. Tundra grey is sourced from Turkey.

Fredericia Standard Fabrics

The Fredericia Standard Fabrics are a range of state-of-the-art upholstery fabrics recommended for the Fredericia product range. Textiles can be supplied in flame-retardant qualities that meet the requirements of the British Standard (BS) and California Technical Bulletin (CAL 117) fire safety law. For extended range of textiles, please see our Textile supplier overview.

*ATTENTION: Velour can have press marks (where pile naps have tendency to lay down) either from transport or in use. This is a typical property of velour and it is not to be seen as a defect.

NAME	COMPOSITION	MARTINDALE	ENVIRONMENTAL	FABRIC GROUP	BRAND
Connect	48% WO / 41% recycled PL / 9% PA / 2% virgin PL	90.000	EU Ecolabel	0	Gabriel
Bardal	70% WO / 30% VI	62.000	EU Ecolabel	1	Gudbrandsdalens Uldvarefabrik
Capture	85% WO / 15% PA	+100.000	EU Ecolabel	1	Gabriel
Grand Linen	100% LI	30.0000	Oeko-Tex 100	1	Fredericia / Libeco
Linara	63% CO / 37% LI	36.000	Oeko-Tex 100	1	Romo
Natural linen	91% / LI / 9% PA	28.000	Oeko-Tex 100	1	Fredericia / Libeco
Remix	90% WO / 10% PA	+100.000	EU Ecolabel	1	Kvadrat
Re-wool	45% WO (45% recycled WO) / 10% PA	100.000	EU Ecolabel	1	Kvadrat
Barnum	45% CO / 19% VI / 15% WO / 13% PC / 8% PA	60.000	Oeko-Tex 100	2	Nevotex
Fiord	92% WO / 8% PA	60.000	EU Ecolabel	2	Kvadrat
Hallingdal	70% WO / 30 % VI	+100.000	EU Ecolabel	2	Kvadrat
Loop	46% PAN / 23% WO / 15% CO / 12% PA / 4% PL	60.000		2	Kirkby Design (Romo)
Ruskin	70% VI / 15% LI / 10% WO / 5% PA	60.000		2	Romo
Savoy*	100% Trevira CS	+100.000	EU Ecolabel	2	Gabriel
Steelcut trio	90% WO / 10% PA	+100.000	EU Ecolabel	2	Kvadrat
Clay	76% LI / 21% CO / 3% PL	45.000	Greenguard Gold	3	Sahco (Kvadrat)
Divina Melange	100% WO	45.000	EU Ecolabel	3	Kvadrat
Foss	76% WO / 11% VI / 8% PA / 5% LI	100.000	EU Ecolabel	3	Kvadrat
Harald*	100% CO	+100.000	Greenguard Gold	3	Kvadrat
Sunniva	58% WO / 25% VI / 8% LI / 5% PA / 4% PL	50.000	Greenguard Gold	3	Kvadrat
Vidar	94% WO / 6% PA	+100.000	EU Ecolabel	3	Kvadrat
Cotil 863	54% WO / 44% CO	30.000		4	Cotil
Elle	25% CO / 20% VI / 20% WO / 20% PC / 15% PA	70.000	Greenguard	4	Sahco (Kvadrat)
Safire	43% VI / 17% PAN / 15% WO / 9% CO / 8% PL / 8% LI	+100.000	Greenguard	4	Kvadrat Raf Simons
Sisu	99% WO / 1% PL	70.000	Greenguard Gold	4	Kvadrat
Gentle	60% WO / 20% PA / 20% PL	90.000	Greenguard Gold	5	Kvadrat Febrik
Grand mohair*	100% Mohair (cotton base)	+100.000	Oeko-Tex 100	5	Danish Art Weaving

Textile supplier overview

Textile supplier overview

Shows numerous fabric options graded into the Fredericia price group structure and therefore surpass C.O.M procedure. Not all fabrics shown are suitable for all products, and Fredericia reserves the right to reject certain combinations of fabric and furniture.

For sample swatches please refer to the suppliers.

KVADRAT/SAHCO/FEBRIK	FABRIC GROUP		FABRIC GROUP		FABRIC GROUP
Floyd	0	Divina / Divina MD	3	Zero	3
Guest	0	Ecriture	3	Beda	4
Canvas	2	Keiga	3	Moss	4
Haku	2	Nalia	3	Byram	5
Maple	2	Tonica	3	Helia	5
Steelcut/Quartet	2	Tonus	3		

GABRIEL	FABRIC GROUP		FABRIC GROUP	NEVOTEX	FABRIC GROUP
Grain	1	Crisp	2	Erik	1
Passion	1	Focus / Focus Melange	2	Megan	1
Parcel loop	1	Mood	2	Njord	1
Select	1	Nobel	2	Illusion	2
Breeze Fusion	2	Savak	3		

ROMO GROUP	FABRIC GROUP		FABRIC GROUP	GUDBRANDSDALENS ULDFABRIK	FABRIC GROUP
Elio	1	Soho	2	Amdal	2
Smooth	1	Fibre	3	Hemsedal	4
Fleck Eco	2	Tosca	4		

DEDAR	FABRIC GROUP	JAB	FABRIC GROUP	VESCOM	FABRIC GROUP
Voulez Vous	3	City Velvet	2	Acton	1
Adamo & Eva	4			Auckland	2
Karakorum	5			Foster	2
				Moore	2

CAMIRA	FABRIC GROUP
Blazer	1
Main Line Flax	1
Yoredale	2

Fredericia Leather

From surface finish to colour range, the leathers in the Fredericia Leather Collection are fine-tuned to complement the product range, both visually and in material tactility. The tanning processes are kept in enclosed systems to minimise local water pollution and environmental impact. All leathers are tanned in Italy or Sweden. Each partner tannery is monitored and supervised to secure Fredericia's ethical and quality standards.

NAME	COLOURS	TYPE	ENVIRONMENTAL	DESCRIPTION	LEATHER GROUP
Vice	11 Black	Pigmented Corrected grain 1,2-1,4 mm	European hides Chrome III tanned in Italy Blau e Engel Ecolabel	The leather surface is corrected with an even grain pattern embossment. Vice is an extremely durable leather. Reduced breathability.	0
Omni	112 Warm grey 293 Burnt sienna 301 Black 307 Cognac 320 Dark clay 377 Dark brown	Semi-aniline, Full grain 1,2-1,4 mm	European hides Chrome III tanned in Italy Blau e Engel Ecolabel	Elegant leather with harmonuous and regular full grain structure and a comfortable touch. User friendly with good protection against dirt and light, while being durable. All Omni colours are available as CRIB5 with pricing in Leather group 2 Omni 301, 307 & 377 available with SPOOR traceability no. verifying the origin of the raw with pricing in Leather group 2	1 (w/ CRIB5: 2)
Primo	74 Umbra grey 75 Cognac 86-1 Dark brown 88 Black	Semi-aniline Full grain 1,5-1,7 mm	European hides Chrome III tanned in Italy Blau e Engel Ecolabel	Classic full-grain semi-aniline leather made from the best bull hides. A precise protective layer gives a comfortable touch with good breathability, while adding resitance to dirt.	2
Trace	8146 Olive 8175 Black 8680 Heritage brown 8870 Light tan	Semi-aniline Full grain 1,2-1,4 mm	Danish & Swedish hides Processed in Denmark, tanned in Germany. Chrome free Biodegradable & compostable	Trace is a semi-aniline leather developed specifically for Fredericia in Collaborattion with Spoor, where the hides are traceable down to the specific animal. The leather is elegant with a rich depth in colour. Comes from the finest sorting of hides limited to Denmark and Sweden.	2
Max	91 Nutshell 92 Tan 93 Indian red 95 Cognac 96 Dark brown 98 Black	Aniline Full grain 1,2-1,4 mm	European hides Chrome III + vegetable tanned in Italy Blau e Engel Ecolabel	Luxurious aniline leather with a natural open-pored texture, made from the absolute top selection bull hides. The leather is highly breathable and comfortable with a smooth surface and tight structure. Max 95 & 98 available with SPOOR traceability no. verifying the origin of the raw with pricing in Leather group 4.	3
Cera	905 Russet brown	Aniline Full grain 1,1-1,3 mm	European hides Chrome III tanned in Italy Blau e Engel Ecolabel	A luxurious full-grain aniline leather which has been finished with a light wax resulting in a smooth surface with a silky feel. An open-pored leather that is highly breathable with a tight and elegant structure. Cera is made from the absolute top selection bull hides primarily from Norway and Switzerland.	4
Vegeta	90 Natural	Aniline (uncoloured) Full grain 1,2-1,4 mm	European hides Vegetable tanned in Italy Blau e Engel Ecolabel	Produced from the absolute top selection of hides. Vegeta has a natural open-pored texture, making the leather highly breathable. The leather acquires a unique patina and darkens over time.	4
Organic	906 Mocca	Semi-aniline Full grain 1,1-1,3 mm	Scandinavian hides Vegetable tanned in Sweden Organic content certified	Visible marks and variation in the surface coming from a free-ranging animal life is to be expected. Raw hides are traceable to certified organic cattle.	4
Nubuck	501 Light sand 502 Warm grey 506 Anthracite 512 Olive	Nubuck Sanded full grain 1,2-1,5 mm	European hides Chrome III tanned in Italy Blau e Engel Ecolabel	A full-grain aniline hide has been lightly sanded to obtain an exclusive matte effect. Tanning includes Scotchguard protection.	4

Leather supplier overview

Leather supplier overview

Shows numerous leather options graded into the Fredericia price group structure.

Not all leathers shown are suitable for all products, and Fredericia reserves the right to reject certain combinations of leather and furniture. Minimum order quantity required from external leather suppliers is a consumption of at least 5m2.

For sample swatches please refer to the suppliers.

	LEATHER GROUP 1	LEATHER GROUP 2	LEATHER GROUP 3	LEATHER GROUP 4	LEATHER GROUP 5
Stolz (minimum pcs = 5 m2)		Select	Cervo	Velvet	
		Atlas		Vegetal	
Sorensen (minimum pcs = 5 m2)	Ultra crib 5	Triumph crib 5	Dunes	Terra	Elegance
	Optimo	Spectrum			
	Nuance	Flux			

A leather card of selected Sorensen Leathers can be ordered through Fredericia Customer Care.

We are here to help you

Customer Care & Aftersales

Mon–Thu: 08.00–16.00
Fri: 08.00–15.30

customerservice@fredericia.com
+45 7592 3344

Essential Assortment

Our Essential Assortment is a curated selection of our products which has been pre-configured from our general pricelist. The entire assortment will be available with all required metadata, making it suitable for e-commerce. Our Essential Assortment will be supported thoroughly by image material and have a consistent delivery time.

Important notice:

The Essential Assortment has been pre-configured in all aspects including foam, upholstery, gliders etc. Changes in the configuration is not possible. If this is needed we refer to our general pricelist-matrix.

For upholstered furniture the standard foam will always be HR foam. If CMHR foam (UK approved) is needed this is considered a special variant, and must be configured in the general pricelist-matrix.

Customers Own Materials

Fredericia offers to upholster in custom-specific fabric and leather (C.O.M), after approval from Fredericia's quality department. For fabric and leather not included in Fredericia's standard Fabrics and Graded-in programmes we require a sample of at least 30x30cm. The physical sample and materials should be sent to Fredericia with the Fredericia C.O.M. forms attached.

C.O.M. sample form:
<http://www.fredericia.com/general/COMsampleform.pdf>

C.O.M. material form:
<http://www.fredericia.com/generaUCOMmaterialform.pdf>

The forms are also available through customer care & aftersales at customerservice@fredericia.com

Please be aware that if Fredericia receives materials and samples with insufficient information, delivery times will be affected.

Address:
Fredericia Furniture A/S
Treldevej 183
Gate 2
DK-7000 Fredericia

Table size seating overview

























MODEL	PRODUCT	SIZE (CM)	TABLE HEIGHTS AVAILABLE	SEATS (PATO)
6624	Plan Table	70 x 60	Dining, counter and bar height	
6627	Plan Table	Ø72	Dining, counter and bar height	
6629	Plan Table	Ø90	Dining, counter and bar height	
6631	Plan Table Fixed	200 x 100	Dining, counter and bar height	
6632	Plan Table Extendable	200/260 x 100	Dining height	
667B	Plan Table, Configuration B	120 x 260	Dining, counter and bar height	
667D	Plan Table, Configuration D	120 x 320	Dining, counter and bar height	
667F	Plan Table, Configuration F	120 x 380	Dining, counter and bar height	
667H	Plan Table, Configuration H	120 x 440	Dining, counter and bar height	

Table size seating overview

MODEL	PRODUCT	SIZE (CM)		SEATS (J39)
6292	Mogensen C18 Table	160 x 80	Shaker-style frame allows for any chair width	
6290	Mogensen C18 Table	180 x 90	Shaker-style frame allows for any chair width	
6293	Mogensen C18 Table	220 x 90	Shaker-style frame allows for any chair width	
6284	Mogensen 6284 Table	180 x 90		
6286	Mogensen 6286 Table	195 x 97,5	Shaker-style frame allows for any chair width	
6386	Mogensen 6386 Table	245 x 97,5	Shaker-style frame allows for any chair width	
6106	Taro	220 x 93,5		
6121	Taro	Ø120		
6438	Post Table	225 x 100		
6440	Post Table	265 x 100		
6441	Post Table	270 x 100		
6442	Post Table	320 x 100		
6490	Ana	220 x 95 Extra length: 320 x 95		 
6491	Ana	180 x 95 Extra length: 280 x 95		 

Terms and conditions of sale and delivery for Fredericia Furniture A/S

Sale and claim process

Our Customer Care team is ready to assist you with the ordering and claim process.

Offer

You can request an offer by sending an e-mail to our Customer Care team at the following e-mail address: quote@fredericia.com

Any offer is made subject to errors, omissions and other inconsistencies, including misspellings. The stated dates of delivery are indicative only, as Fredericia reserves the right to change the dates of delivery in the final order confirmation.

Offers are binding for Fredericia for 60 days from the date of the offer, unless the price list is updated with new prices within 60 days from the date of the offer, or unless another deadline is expressly stated in the offer.

How to place an order

You can place an order by emailing our Customer Care team via the following email address: salesorder@fredericia.com

Please make sure your order is correct and includes all the information needed to process it, such as quantity/size/color/legs/gliders etc. Please also use the correct product name as stated in our pricelist.

Receiving the order confirmation

You will receive the order confirmation as soon as the order has been entered into our system. You can usually expect to receive this confirmation within 48 hours from sending the order.

Please always check the order confirmation as soon as possible after receiving it and contact us immediately if you find any discrepancies.

Changes or cancellations of orders

In general, we advise to keep cancellations to a minimum, but if changes or cancellations are needed, following rules apply.

- Changes to orders later than three working days after receipt of the order confirmation may affect both delivery and price, and a surcharge of EUR 40 / DKK 300 / SEK 420 / NOK 420 will be charged.
- If an order is canceled later than three days after the order confirmation, a fee of at least 10 % of the order amount will be charged. In addition, if customer-specific materials have been ordered and confirmed, an amount corresponding to the cost of this will be charged.

Returns

Returns are generally not accepted.

If you wish to return products, this can only be done with prior written agreement with Fredericia.

Terms of delivery

Please find the expected week of dispatch in your order confirmation.

If your order is delayed for various reasons, we will inform you of the new expected delivery week whenever possible.

If the delay exceeds 3 months and is not due to force majeure, you have the right to cancel the order. If a confirmed shipment is postponed at the customer's request, Fredericia reserves the right to invoice the total order amount on the originally agreed shipment date.

Fredericia cannot be held responsible for delivery issues or delays due to force majeure.

Requests for non-standard fabric 'Graded-in, COM and COL'

Graded-in fabric

We offer a large selection of fabrics and leathers in our standard fabric program which are listed in the pricelist. These have been carefully selected by the Fredericia design team.

In addition, we offer a wider range of graded-in fabrics for upholstery. If graded-in fabrics are requested, we will inform you whether a specific fabric is suitable for the requested design and cost. Please contact our Customer Care.

COM fabrics and COL leather

Fredericia offers upholstery in customer-specific fabric and leather (COM and COL), after approval by Fredericia quality department. For textiles and leather that do not appear in Fredericia's standard or Graded-in program, we require a sample of at least 30 x 30 cm for testing, to determine whether the fabric is suitable for the design.

To proceed with COM fabric or leather, please send your request to our Customer Care team via customerservice@fredericia.com

Materials sent to Fredericia are delivered as "DDP - delivered duty paid". Fredericia reserves the right to change the delivery time and charge a fee if the material is not delivered as described above. Please note that customs and other expenses in connection with sending material samples are for the customer's own account.

Product range

Fredericia has the right to cease production of certain products without notice.

Dimensions and tolerances

The stated dimensions are indicative and may vary, and deviations from a product's stated dimensions may occur. Any color or wood samples must be considered indicative. Fredericia cannot be held responsible for any differences between samples and the delivered products, and small variations in colors or wood materials may occur in large orders, as the products change naturally over time. Such variations are not considered manufacturing defects.

Reservation of ownership

Fredericia reserves, with the limitations resulting from inalienable legal rules, ownership of the sold item until the entire purchase price plus accrued costs has been paid to Fredericia.

Claims

We are dedicated to processing your claim efficiently, and we strive to respond as soon as possible. We kindly ask you to register your claim as soon as you find a defect in your product.

Please send your claim to service@fredericia.com including information as, pictures, item description, order number, dimensions, defect description, pictures of any visible stamps on the product etc. It is possible to fill in a claim form via below link, to secure all necessary information included in the inquiry.

<https://fredericia.com/da-DK/professionals#/gallery/Claims>

If the claim is accepted, Customer Care places an order for a new product or remedy the defect, by ordering a spare part or securing a repair.

Replacement orders or spare parts are only delivered to the same delivery address as the original order. Costs in connection with delivery or installation at the end customer are not covered by Fredericia. Cost for delivering a replacement or sparepart to the original address is covered by Fredericia. We will inform you whether you should return the defective product.

Product liability

Fredericia is liable if a delivered product causes personal injury or causes damage to property, if the object in question is, by its nature, usually intended for commercial use and is mainly used by the injured party accordingly.

Fredericia is not responsible for damage to commercial property, unless it is documented that the damage is due to errors on Fredericia's part that should not have been prevented by the Buyer's examination of the delivered products.

If a third party makes a claim for compensation for product liability against the Buyer, the Buyer must immediately notify Fredericia in writing.

Limitation of liability

Fredericia's liability is in all respects limited to the following.

Fredericia assumes no liability for losses caused by delay, defects or other non-compliance, unless the loss is caused by gross negligence on Fredericia's part.

Fredericia assumes no responsibility for indirect losses, including loss of goodwill, lost profits (e.g. loss of profit), operating losses, running costs or loss of clientele.

Fredericia's liability for damages in relation to a single order is in all cases limited to the value of the order in question calculated as the total purchase price excluding VAT.

- If the product has been abused, misused, or cleaned using wrong cleaning methods
- Damage due to normal wear and tear
- If the product has been placed outdoors or in a humid environment
- If the product has been exposed to prolonged strong sunlight or heat.
- If a product deviates from a sample of wood or fabric. As the material matures naturally over a period, samples can only be considered as a guiding
- Cane wicker is excepted from the extended warranty, and a two-year warranty is provided.

Products manufactured according to customer specifications are not covered by Fredericia's test certificates regarding strength, durability and stability, and Fredericia therefore gives no warranty in this regard.

The original purchase invoice is mandatory when a claim is made under the extended warranty.

Replaced products or replaced product parts shall become the property of Fredericia. Delivery of a replacement product or repair of a product does not result in a renewal or extension of the applicable warranty period.

Any inquiries or questions related to this warranty should be directed to our Customer Care department.

Warranty

Extended product warranty

Fredericia offers an extended warranty against production and construction defects. The warranty covers faults which were present at the time of purchase, or which have arisen due to faults which were present at the time of purchase. The warranty period is calculated from the date of the original invoice. During the applicable warranty period, Fredericia will, at its sole obligation and its sole discretion, either repair, replace or issue a credit note regarding the defective product, the defective part or the defective components.

Extended product warranty applies from products purchased after 1st of January 2023.

25-year warranty

A 25-year warranty is provided on selected models:

- The Spanish Chair (2226)
- OX og Queen Chair (1000/1010)
- Corona Chair (5000)
- BM 22 collection by Børge Mogensen

10-year warranty

A 10-year warranty is provided on sofas.

7-year warranty

A 7-year warranty is provided on armchairs, chairs, tables, coffee tables and smaller pieces of furniture under our Complements collection (e.g. side tables).

2-year warranty

A 2-year warranty is provided on lamps and accessories, including vases and loose spare parts.

The warranty does not apply in the following situations (the list is non-exhaustive):

- COM – customer leather, customer fabrics or material ordered separately
- In cases of consequential or incidental damage
- If the product has been stored, assembled, or maintained wrongly
- In the attempt of a failed repair or modification of the product without Fredericia's consent.

Transport

Standard delivery

Delivery of goods from Fredericia is deemed to have occurred when the customer has received the goods. Standard delivery will be made to the same country as the invoicing address. All orders are shipped with the best suitable carrier and week of dispatch is indicated on your order confirmation. The stated delivery date is indicative and may therefore be waived. Standard delivery addresses cannot be located in a country different from the country of the invoicing address.

Non-standard delivery address

For orders above a high minimum order value, we are able to deliver to a non-standard delivery address. If a non-standard delivery address is requested, your Customer Care representative will send you a form to be filled out with details. Any changes to the sales order or delivery booking cannot be made before the form has been returned.

Any request for delivery to a non-standard delivery address, may be charged with a special delivery surcharge calculated on a case by case basis.

Any special requirements on delivery, ex. use of lorry with a tail lift etc. may be charged with a special delivery surcharge calculated on a case by case basis.

Please check the delivery surcharges with our Customer Care.

Change of delivery address

- Changes to delivery address can be made up until two weeks before confirmed dispatch week, however changes will be charged a fee of EUR 40 / DKK 300 / SEK 420 / NOK 420.
- Changes to delivery address less than two weeks before confirmed dispatch week, will be charged a fee of EUR 100 / DKK 750 / SEK 1.050 / NOK 1.050.
- Changes to delivery address after the order has left our warehouse, an extra fee will be added depending on the status of the delivery.

Please contact your Customer Care representative in all cases.

Fix delivery / delivery of low amount orders

Please inform your Customer Care representative if you need a fixed date or time for your order, so that we can include this in your order confirmation.

Fixed delivery on a specific date, will be charged an extra fee of EUR 100 EUR / DKK 750 / SEK 1.050 / NOK 1.050.

Fixed delivery on a specific timeslot, will be charged an extra fee of EUR 100 EUR / DKK 750 / SEK 1.050 / NOK 1.050.

We reserve the right to change confirmed date and time of delivery due to force majeure.

For the delivery of smaller orders with a value below EUR 700 / DKK 5,200 / SEK 7,000 / NOK 7,000 a separate shipping surcharge of EUR 60 / DKK 450 / SEK 870 / NOK 870 will be applied.

For the delivery of spare parts unrelated to a claim with a value below EUR 700 / DKK 5,200 / SEK 7,000 / NOK 7,000 a separate shipping surcharge of EUR 10 / DKK 75 / SEK 110 / NOK 110 will be applied.

Standard delivery conditions

Standard delivery conditions to addresses located within Europe is either "DAP – Delivered At Place" or "DDP – Delivered Duty Paid", unless stated otherwise on your order.

Standard delivery conditions to addresses located outside Europe is "EXW – Ex Works", unless stated otherwise on your order.

For specific information about your delivery conditions, please see your order confirmation or contact our Logistics department.

Transport damages and missing products

Upon delivery, it is your responsibility to check the delivery for visible

damages. If the delivery does not comply with your expectations, reservations should be made on the delivery note and expressly noted to the carrier immediately on the CMR document. The note must include a clear and detailed description of whether the products are damaged, wet etc. For documentation purposes, please make sure to take pictures of the damaged pallets, packaging or products right after delivery and forward them according to our claim procedure.

Missing products should be noted on the delivery note and CMR document. Please contact our Customer Care immediately after delivery and confirmation of missing products. We will investigate the missing delivery in our supply chain and logistics. If no proper documentation and pictures is provided and the claim is not received within 72 hours of receipt of the goods, Fredericia is not obligated to accept the claim.

Non-visible damage

If there are no visible damages to the exterior of the packaging or the products upon receipt, but visible damages to the products are discovered after the opening of the packaging, it must be reported to us in writing. You are required to take photographs of the product and the packaging and submit them to us along with a written report as soon as they are discovered, and no later than 7 days after receipt.

Payment

Any questions to making payments, our accounting department is always at your service to assist. Our accounting department can be contacted on economy@fredericia.com.

Payment information

All payments must be made using bank transfer to Fredericia's account at the Buyer's expense, unless another payment method is agreed in writing. The payment information for bank transfers, such as the IBAN number and SWIFT code, can be found on your sales order or -invoice.

For sales invoices:

- Please refer to the invoice number in the payment description. It is possible to combine payments for several invoices in one transfer. All invoices paid must be referenced in the payment description.

For sales orders (prepayment / payment-before-production):

- Please refer to the sales order number (SO123456) in the payment description. If missing payment description with proper referencing, Fredericia reserve the right to change the confirmed date and time of delivery on your expense.

Debtor policy

New customers at Fredericia are obliged to make a prepayment on the first three orders. Please note that the prepayment must happen before initiating the production of the submitted order. Credit assessment may be requested for subsequent orders. For customers with a credit limit, this can be disclosed by the sales- or customer service representative. If the credit limit for an account is reached, Fredericia requires previous invoices to be paid in full before new orders can be placed.

Invoices and prepayments of sales orders must be paid on time. If a due date is exceeded, payment reminders will be sent followed by debt collection and temporary closure of the account.

Fredericia has the right to impose interest of 2.0% per month started from the day after the due date and until full payment has been made. Fees for payment reminders are charged in accordance with applicable law.

Failure to make timely payment for an order will be considered a material breach. In the event of non-payment, Fredericia has the right to withhold all further deliveries to the customer. Fredericia assumes no responsibility as a result of withholding deliveries, regardless of whether such deliveries are interconnected.

Payment to Fredericia cannot be withheld on the basis that the product is defective, unless Fredericia has acknowledged the claim.

Reminders

- First reminder: five (5) days after due date
- Second reminder: ten (10) days after the first reminder was sent.
- Third reminder: ten (10) days after second reminder was sent. On third reminder, we inform you that your account has been suspended for further orders and will also include notification of debt collection.

Account suspension and reactivating account

For accounts that has been suspended, Fredericia will not process or deliver orders (confirmed/not confirmed) until the overdue amount has been paid.

Once the overdue amount has been paid, the account suspension will be revoked and confirmed orders will be processed and shipped as indicated on your order.

For accounts that has been suspended and reactivated, the general payment terms will be revoked, and the following three order must again be prepaid according to the debtor policy. Fredericia will decide if the general payment terms can be changed depending on your payment history.

Bank account information

Fredericia can receive payments using the following currency accounts depending on invoice/order currency. If payment is made to a below account that differs from its main currency, Fredericia reserve the right to add surcharges depending on the bank fees.

Always use the bank information provided on your sales invoice or -order.

CURRENCY	IBAN	SWIFT/BIC
DKK	DK8920000440300510	NDEADKKK
EUR	DK0320005005892335	NDEADKKK
NOK	NO7460210722087	NDEANOKK
SEK	SE3695000099601819659515	NDEASESS

CONTACT

Fredericia Furniture A/S
Treldevej 183
7000 Fredericia
customerservice@fredericia.com
www.fredericia.com

Chairs & Stools

Model 3261

BM61 Chair Cane wicker



Designed by Børge Mogensen, 1958

Chair in solid wood with seat and back in cane webbing. Mounted with interchangeable quick-click plastic glides. Separate felt glides included.

Modeldetails

0,25 m³ Packaging dimensions:
6 kg / L: 55 cm W: 55 cm H: 82,5 cm
4,3 kg

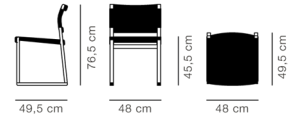

Essential Assortment

Item number	Wood	Seat and back	Price
32611024000	Oak lacquer	Cane wicker, natural	2.410

Order configuration

	Oak lacquered	Oak oiled
Natural cane wicker	2.410	2.625

Model 3361

BM61 Chair Linen webbing



Designed by Børge Mogensen, 1958

Chair in solid wood. Seat and backrest of linen webbing. Mounted with interchangeable quick-click plastic glides. Separate felt glides included.

Modeldetails

0,25 m³ Packaging dimensions:
5,4 kg / 4,4 kg L: 55 cm W: 55 cm H: 82,5 cm

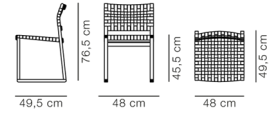

Essential Assortment

Item number	Wood	Seat and back	Price
33610063100	Oak black lacquered	Linen webbing black	1.105
33611023000	Oak lacquer	Linen webbing natural	1.225

Order configuration

	Oak black lacquered	Oak lacquered	Oak oiled
Natural webbing	1.205	1.225	1.375
Black webbing	1.105		

Certifications

EN 1022:2005, EN 16139:2013 (L2)

Model 3262

BM62 Armchair Cane wicker



Designed by Børge Mogensen, 1958

Armchair in solid wood with seat and back in cane webbing. Mounted with interchangeable quick-click plastic glides. Separate felt glides included.

Modeldetails

0,32 m³ Packaging dimensions:
7,3 kg / 5,1 kg L: 55 cm W: 67 cm H: 82,5 cm

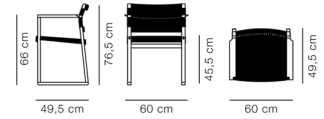

Essential Assortment

Item number	Wood	Seat and back	Price
32621024000	Oak lacquer	Cane wicker, natural	3.010

Order configuration

	Oak lacquered	Oak oiled
Natural cane wicker	3.010	3.085

Model 3362

BM62 Armchair Linen webbing



Designed by Børge Mogensen, 1958

Chair in solid wood. Seat and backrest of linen webbing. Mounted with interchangeable quick-click plastic glides. Separate felt glides included.

Modeldetails

0,3 m³ Packaging dimensions:
6,2 kg / 5,2 kg L: 55 cm W: 67 cm H: 82,5 cm

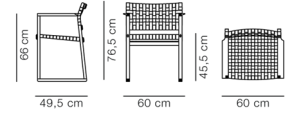

Essential Assortment

Item number	Wood	Seat and back	Price
33620063100	Oak black lacquered	Linen webbing black	1.265
33621023000	Oak lacquer	Linen webbing natural	1.420

Order configuration

	Oak black lacquered	Oak lacquered	Oak oiled
Natural webbing	1.340	1.420	1.490
Black webbing	1.265		

Certifications

EN 1022:2005, EN 16139:2013 (L2)

Model 4810

Eyes 4 Leg Chair Tube base



Designed by Foersom & Hiort-Lorenzen, 2007

Chair with shell in moulded cold cured foam reinforced with steel, fully upholstered in fabric or leather. Base of steel tube mounted with plastic glides. Felt glides available.

Modeldetails

0,4 m³ Packaging dimensions:
13 kg / 10 kg L: 68 cm W: 62 cm H: 96 cm

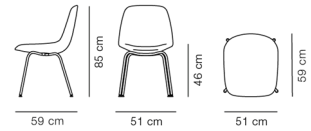

Essential Assortment

Item number	Upholstery	Frame	Price
4810193000006000503	Re-Wool 198	Black	705
48101931100006000503	Re-Wool 128	Black	705
48104452400006000603	Gentle 873	Brushed stainless steel	1.060

Essential variants are delivered with plastic glides and HR foam

Order configuration

	Black	Brushed stainless steel
Fabric group 0	710	710
Fabric group 1	765	765
Fabric group 2	845	845
Fabric group 3	880	880
Fabric group 4	995	995
Fabric group 5	1.190	1.190
C.O.M. fabric	765	765
Leather group 0	1.145	1.145
Leather group 1	1.235	1.235
Leather group 2	1.375	1.375
Leather group 3	1.595	1.595
Leather group 4	1.705	1.705
Leather group 5	1.965	1.965
C.O.M. leather	1.235	1.235

Fabric consumption: 1,2 m. Leather consumption: 2,5 m²

As standard delivered without decoration buttons.

Extra charge for

Buttons in the same upholstery as the chair or in selected leather: +103

Certifications

EN 1022:2005, EN 16139:2013 (L2)

Recommended upholstery

Fabric group 0	Connect
Fabric group 1	Re-wool, Remix, Bardal, Capture, Linara, Natural Linen, Erik
Fabric group 2	Hallingdal, Barnum, Fiord, Steelcut Trio, Loop, Ruskin
Fabric group 3	Sunniva, Vidar, Foss, Divina Melange, Clay
Fabric group 4	Safire, Sisú, Elle, Cotil 863
Fabric group 5	Gentle
Leather group 0	Vice
Leather group 1	Omni
Leather group 2	Primo, Trace
Leather group 3	Max
Leather group 4	Vegeta, Organic, Nubuck, Cera

Model 4830

Eyes 4 Leg Barstool



Designed by Foersom & Hiort-Lorenzen, 2007

Barstool with shell in moulded cold cured foam reinforced with steel, fully upholstered in fabric or leather. Base of steel tube mounted with plastic glides. Felt glides available. Please specify bar or counter height.

Modeldetails

0,55 m³ Packaging dimensions:
15 kg / 12 kg L: 65 cm W: 66 cm H: 129 cm

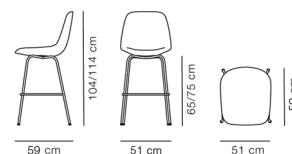

Essential Assortment

Item number	Upholstery	Frame	Price
4830193000006000523	Re-Wool 198	Black, 75 cm	1.000
48301931100006000523	Re-Wool 128	Black, 75 cm	1.000
48304452400006000623	Gentle 873	Brushed stainless steel, 75 cm	1.415

Essential variants are delivered with plastic glides and HR foam

Order configuration

Bar or counter height.

	Black	Brushed stainless steel
Fabric group 0	1.000	1.000
Fabric group 1	1.075	1.075
Fabric group 2	1.155	1.155
Fabric group 3	1.190	1.190
Fabric group 4	1.300	1.300
Fabric group 5	1.565	1.565
C.O.M. fabric	1.075	1.075
Leather group 0	1.435	1.435
Leather group 1	1.540	1.540
Leather group 2	1.685	1.685
Leather group 3	1.905	1.905
Leather group 4	2.015	2.015
Leather group 5	2.320	2.320
C.O.M. leather	1.540	1.540

Fabric consumption: 1,2 m. Leather consumption: 2,5 m²

As standard delivered without decoration buttons.

Black frame, 65 cm in height, available while stocks last.

Extra charge for

Buttons in the same upholstery as the chair or in selected leather: +103

Certifications

EN 1022:2005, EN 16139:2013 (L1)

Recommended upholstery

Fabric group 0	Connect
Fabric group 1	Re-wool, Remix, Bardal, Capture, Linara, Natural Linen, Erik
Fabric group 2	Hallingdal, Barnum, Fiord, Steelcut Trio, Loop, Ruskin
Fabric group 3	Sunniva, Vidar, Foss, Divina Melange, Clay
Fabric group 4	Safire, Sisu, Elle, Cotil 863
Fabric group 5	Gentle
Leather group 0	Vice
Leather group 1	Omni
Leather group 2	Primo, Trace
Leather group 3	Max
Leather group 4	Vegeta, Organic, Nubuck, Cera

Model 4808

Eyes Cantilever Armchair



Designed by Foersom & Hiort-Lorenzen, 2007

Chair with shell in moulded cold cured foam reinforced with steel, fully upholstered in fabric or leather. Cantilever base in steel with leather armrests. Mounted with plastic glides.

Modeldetails

0,4 m³ Packaging dimensions:
13 kg / 10 kg L: 62 cm W: 68 cm H: 97 cm

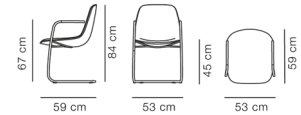

Essential Assortment

Item number	Upholstery	Frame	Price
4808193000006000550	Re-Wool 198	Black, arm with leather 98, black	1.190
48081931100006000550	Re-Wool 128	Black, arm with leather 98, black	1.190
48084452400006000640	Gentle 873	Mat chrome, arm leather 95 cognac	1.720

Essential variants are delivered with plastic glides and HR foam

Order configuration

Arm: Leather (90 natural, 95 cognac or 98 black).

	Black	Mat chrome
Fabric group 0	1.130	1.130
Fabric group 1	1.215	1.215
Fabric group 2	1.305	1.305
Fabric group 3	1.350	1.350
Fabric group 4	1.485	1.485
Fabric group 5	1.780	1.780
C.O.M. fabric	1.215	1.215
Leather group 0	1.645	1.645
Leather group 1	1.770	1.770
Leather group 2	1.940	1.940
Leather group 3	2.205	2.205
Leather group 4	2.335	2.335
Leather group 5	2.685	2.685
C.O.M. leather	1.770	1.770

Fabric consumption: 1,2 m. Leather consumption: 2,5 m²

As standard delivered without decoration buttons.

Extra charge for

Buttons in the same upholstery as the chair or in selected leather: +103

Recommended upholstery

Fabric group 0	Connect
Fabric group 1	Re-wool, Remix, Bardal, Capture, Linara, Natural Linen, Erik
Fabric group 2	Hallingdal, Barnum, Fiord, Steelcut Trio, Loop, Ruskin
Fabric group 3	Sunniva, Vidar, Foss, Divina Melange, Clay
Fabric group 4	Safire, Sisú, Elle, Cotil 863
Fabric group 5	Gentle
Leather group 0	Vice
Leather group 1	Omni
Leather group 2	Primo, Trace
Leather group 3	Max
Leather group 4	Vegeta, Organic, Nubuck, Cera

Model 4818

Eyes Swivel Chair Swivel base



Designed by Foersom & Hiort-Lorenzen, 2007

Chair with shell in moulded cold cured foam reinforced with steel, fully upholstered in fabric or leather. 4-point swivel base in aluminum. Mounted with plastic glides. Felt glides and castors available. The base is not height adjustable.

Modeldetails

0,4 m³ Packaging dimensions:
16 kg / 13 kg L: 62 cm W: 68 cm H: 97 cm

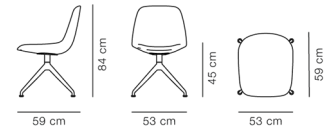

Order configuration

	Black	Polished aluminium
Fabric group 0	985	985
Fabric group 1	1.060	1.060
Fabric group 2	1.140	1.140
Fabric group 3	1.180	1.180
Fabric group 4	1.300	1.300
Fabric group 5	1.560	1.560
C.O.M. fabric	1.060	1.060
Leather group 0	1.445	1.445
Leather group 1	1.555	1.555
Leather group 2	1.705	1.705
Leather group 3	1.935	1.935
Leather group 4	2.055	2.055
Leather group 5	2.360	2.360
C.O.M. leather	1.555	1.555

Fabric consumption: 1,2 m. Leather consumption: 2,5 m²

As standard delivered without decoration buttons.

Extra charge for

Buttons in the same upholstery as the chair or in selected leather: +103
Castors: +26

Certifications

EN 1022:2005, EN 16139:2013 (L1)

Recommended upholstery

Fabric group 0	Connect
Fabric group 1	Re-wool, Remix, Bardal, Capture, Linara, Natural Linen, Erik
Fabric group 2	Hallingdal, Barnum, Fiord, Steelcut Trio, Loop, Ruskin
Fabric group 3	Sunniva, Vidar, Foss, Divina Melange, Clay
Fabric group 4	Safire, Sisu, Elle, Cotil 863
Fabric group 5	Gentle
Leather group 0	Vice
Leather group 1	Omni
Leather group 2	Primo, Trace
Leather group 3	Max
Leather group 4	Vegeta, Organic, Nubuck, Cera

Model 4820

Eyes Swivel Armchair Swivel base



Designed by Foersom & Hiort-Lorenzen, 2007

Chair with shell in moulded cold cured foam reinforced with steel, fully upholstered in fabric or leather. Armrests in stainless steel and leather. 4-point swivel base in aluminum. Mounted with reversible plastic glides which can be changed to felt when reversed. Castors available. The base is not height adjustable.

Modeldetails

0,4 m³ Packaging dimensions:
17 kg / 14 kg L: 62 cm W: 68 cm H: 97 cm

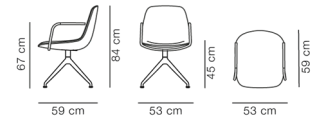

Order configuration

Arm: Leather (90 natural, 95 cognac or 98 black).

	Black	Polished aluminium
Fabric group 0	1.235	1.235
Fabric group 1	1.330	1.330
Fabric group 2	1.410	1.410
Fabric group 3	1.450	1.450
Fabric group 4	1.570	1.570
Fabric group 5	1.885	1.885
C.O.M. fabric	1.330	1.330
Leather group 0	1.695	1.695
Leather group 1	1.825	1.825
Leather group 2	1.975	1.975
Leather group 3	2.210	2.210
Leather group 4	2.325	2.325
Leather group 5	2.670	2.670
C.O.M. leather	1.825	1.825

Fabric consumption: 1,2 m. Leather consumption: 2,5 m²

As standard delivered without decoration buttons.

Extra charge for

Buttons in the same upholstery as the chair or in selected leather: +103
Castors: +26

Certifications

EN 1022:2005, EN 16139:2013 (L1)

Recommended upholstery

Fabric group 0	Connect
Fabric group 1	Re-wool, Remix, Bardal, Capture, Linara, Natural Linen, Erik
Fabric group 2	Hallingdal, Barnum, Fiord, Steelcut Trio, Loop, Ruskin
Fabric group 3	Sunniva, Vidar, Foss, Divina Melange, Clay
Fabric group 4	Safire, Sisu, Elle, Cotil 863
Fabric group 5	Gentle
Leather group 0	Vice
Leather group 1	Omni
Leather group 2	Primo, Trace
Leather group 3	Max
Leather group 4	Vegeta, Organic, Nubuck, Cera

Model 3381

Flamingo Chair Swivel base



Designed by Foersom & Hiort-Lorenzen, 2003

Swivel chair with shell in moulded cold cured foam, CMHR or HR foam, reinforced with steel, fully upholstered in fabric or leather. Cover is non-removable. Swivel base of stainless steel tube, mounted with plastic glides. Natural fibre glides, as an alternative to felt.

Modeldetails

0,4 m³ Packaging dimensions:
18 kg / 15 kg L: 67 cm W: 61 cm H: 93 cm

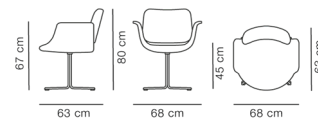

Essential Assortment

Item number	Upholstery	Frame	Price
338100219060140	Hallingdal 130	Brushed stainless steel	1.770
338150093060140	Leather Max 93, Indian red	Brushed stainless steel	2.800
338150095060140	Leather Max 95, Cognac	Brushed stainless steel	2.800
338150098060140	Leather Max 98, Black	Brushed stainless steel	2.800

Essential variants are delivered with plastic glides and HR foam

Order configuration

	Black	Brushed stainless steel
Fabric group 1	1.680	1.680
Fabric group 2	1.795	1.795
Fabric group 3	1.850	1.850
Fabric group 4	2.010	2.010
Fabric group 5	2.410	2.410
C.O.M. fabric	1.680	1.680
Leather group 0	2.195	2.195
Leather group 1	2.360	2.360
Leather group 2	2.590	2.590
Leather group 3	2.950	2.950
Leather group 4	3.130	3.130
Leather group 5	3.595	3.595
C.O.M. leather	2.360	2.360

Fabric consumption: 1,5 m. Leather consumption: 2,5 m²

Extra charge for

Glides with natural fibre: +24

Recommended upholstery

Fabric group 1	Remix, Capture, Bardal, Re-wool, Linara, Natural Linen, Erik
Fabric group 2	Hallingdal, Barnum, Loop, Steelcut Trio, Fiord, Ruskin
Fabric group 3	Divina Melange, Vidar, Sunniva, Foss, Clay
Fabric group 4	Elle, Sisu, Safire
Fabric group 5	Grand Mohair, Gentle
Leather group 0	Vice
Leather group 1	Omni
Leather group 2	Primo, Trace
Leather group 3	Max
Leather group 4	Nubuck, Vegeta, Organic, Cera

Model 3239

J39 Mogensen Chair



Designed by Børge Mogensen, 1947

Chair in solid wood with woven paper cord seat. Back in wood moulded in layers.

Modeldetails

0,3 m³ Packaging dimensions:
6,2 kg / 4,8 kg L: 53 cm W: 55 cm H: 101 cm

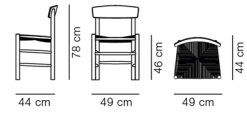

Essential Assortment

Item number	Seat	Wood	Price
32392172510	Natural paper cord	Beech black lacquer, FSC Mix 70%	445
32392202510	Natural paper cord	Beech vintage lacquer, FSC Mix 70%	445
32392802510	Natural paper cord	Beech khaki green, FSC Mix 70%	445
32392812510	Natural paper cord	Beech indigo blue, FSC Mix 70%	445
32392822510	Natural paper cord	Beech Heritage red, FSC Mix 70%	445
32392832510	Natural paper cord	Beech pebble grey, FSC Mix 70%	445
32392032510	Natural paper cord	Oak soap, FSC Mix 70%	695
32392052510	Natural paper cord	Oak oil, FSC Mix 70%	695
32392062510	Natural paper cord	Oak light oil, FSC Mix 70%	695
32392242610	Black paper cord	Oak black lacquer, FSC Mix 70%	740

Order configuration

	Oak black lacquered	Beech coloured lacquer	Beech soap	Oak soap	Oak oiled	Oak light oil	Walnut oiled
Seat natural paper cord	695	525	525	695	695	695	840
Seat black paper cord	740						

Beech coloured lacquer: Black, White, Indigo blue, Khaki green, Heritage red, Pebble grey, Vintage lacquered.

Extra charge for

QuickClick glides with or without felt (R3239): +24

Certifications

Oak is FSC® certified
Beech is FSC® certified
Nordic Swan Ecolabel
ANSI/BIFMA X5.4-2020

Model P3239



J39 Mogensen Chair Seat pad

Designed by Fredericia Furniture, 2022

Seat cushion for J39 Mogensen chair. HR Foam with cover in black semi-aniline or Russet brown (cognac) aniline leather and backing in canvas. Produced from excess and scrap leather from own production in Denmark.

Modeldetails

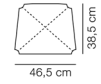

Order configuration

	Leather Cera Russet brown Unit price	Leather Cera Russet brown Total	Leather Primo Black Unit price	Leather Primo Black Total
1 pcs	130	130	130	130
12 pcs	126	1.510	126	1.510
24 pcs	120	2.880	120	2.880

Recommended upholstery

Leather group 2 Primo
Leather group 4 Cera

Model 3207

Klint Chair



Designed by Kaare Klint, 1936

Chair with solid wood frame and a woven paper cord seat. Molded veneer back with core in the same wood as top veneer.

Modeldetails

0,48 m³ Packaging dimensions:
6 kg / 4,5 kg L: 57 cm W: 59 cm H: 87 cm

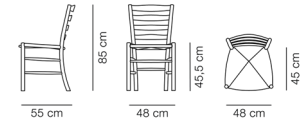

Essential Assortment

Item number	Seat	Wood	Price
32072242500	Natural paper cord	Oak black lacquer, FSC Mix 70%	705
32072032500	Natural paper cord	Oak soap, FSC Mix 70%	945
32072052500	Natural paper cord	Oak oil, FSC Mix 70%	945

Extra charge for

QuickClick glides with or without felt (R3207G): +24

Certifications

FSC® certified
Nordic Swan Ecolabel
EN 1022:2005, EN 16139:2013 (L1)

Model 3208



Klint Armchair

Designed by Kaare Klint, 1936

Armchair with solid wood frame and a woven paper cord seat. Molded veneer back with core in the same wood as top veneer.

Modeldetails

0,3 m³ Packaging dimensions:
9 kg / L: 57 cm W: 61 cm H: 87 cm
5,5 kg

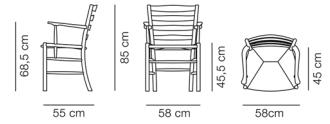

Essential Assortment

Item number	Seat	Wood	Price
32082242500	Natural paper cord	Oak black lacquer, FSC Mix 70%	825
32082032500	Natural paper cord	Oak soap, FSC Mix 70%	1.060
32082052500	Natural paper cord	Oak oil, FSC Mix 70%	1.060

Extra charge for

QuickClick glides with or without felt (R3207G): +24

Certifications

FSC® certified
Nordic Swan Ecolabel
EN 1022:2005, EN 16139:2013 (L1)

Model 3080

Lynderup Chair Wooden seat



Designed by Børge Mogensen, 1954

Stacking chair with steel frame. Interchangeable back and seat of plywood finished with water-based lacquer. Frame of powder coated or chromed tubular steel. Mounted with interchangeable Quick-click glides in plastic. Interchangeable glides in felt are included and delivered with each chair.

Modeldetails

1,64 m³ Packaging dimensions:
6,5 kg / 5,5 kg L: 60 cm W: 71 cm H: 96 cm

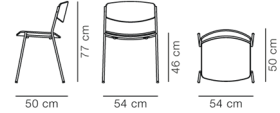

Essential Assortment

Item number	Wood	Frame	Price
30802231791075001	Black ash, FSC Mix 70%	Black lacquer	390
30802021791075001	Oak lacquer FSC Mix 70%	Black lacquer	470
30802261791075001	Walnut lacquer, FSC Mix 70%	Black lacquer	480

Order configuration

	Oak lacquered	Black ash	Walnut lacquered
Black	470	390	480
Chrome	465	405	485

Mounted with Quick-click glides in plastic. Interchangeable glides in felt are included and delivered with each chair.
Stackable: 20 pcs. on trolley, 12 pcs. on floor.

Certifications

EU Ecolabel
FSC® certified
EN 1022:2005, EN 16139:2013 (L1)

Model 3081

Lynderup Chair Seat upholstered



Designed by Børge Mogensen, 1954

Stacking chair with steel frame and upholstered seat. Interchangeable back finished with water-based lacquer. Plywood has beech core with ash, oak or walnut top veneer. Fully upholstered seat upholstered in CMHR or HR foam, covered in fabric or leather. Frame of powder coated or chromed tubular steel. Mounted with interchangeable quick-click plastic glides. Separate felt glides included.

Modeldetails

0,41 m³ Packaging dimensions:
7,5 kg / 6,5 kg L: 60 cm W: 71 cm H: 96 cm

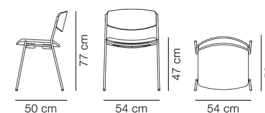

Essential Assortment

Item number	Upholstery	Wood	Frame	Price
30810130302231791075	Connect 60999	Black ash, FSC Mix 70%	Black lacquer	530
30810130102021791075	Connect 60147	Oak lacquer, FSC Mix 70%	Black lacquer	555
30811930002231791075	Re-Wool 198	Black ash, FSC Mix 70%	Black lacquer	565
30810130302261791075	Connect 60999	Walnut lacquer, FSC Mix 70%	Black lacquer	575
30815130102231791075	Leather Omni 301, Black	Black ash, FSC Mix 70%	Black lacquer	590
30811931102021791075	Re-Wool 128	Oak lacquer, FSC Mix 70%	Black lacquer	600
30811930002261791075	Re-Wool 198	Walnut lacquer, FSC Mix 70%	Black lacquer	610
30815130102021791075	Leather Omni 301, Black	Oak lacquer, FSC Mix 70%	Black lacquer	610
30815130102261791075	Leather Omni 301, Black	Walnut lacquer, FSC Mix 70%	Black lacquer	635

Essential variants only delivered with HR foam

Order configuration

Frame: Chrome or black.

	Oak lacquered	Black ash	Walnut lacquered
Fabric group 0	600	565	615
Fabric group 1	615	580	635
Fabric group 2	645	610	665
Fabric group 3	675	640	695
Fabric group 4	730	695	755
Fabric group 5	805	760	825
C.O.M. fabric	615	580	635
Leather group 0	610	580	630
Leather group 1	630	595	650
Leather group 2	660	625	680
Leather group 3	670	635	690
Leather group 4	700	665	720
Leather group 5	805	765	830
C.O.M. leather	630	595	650

Fabric consumption: 0,6 m. Leather consumption: 0,54 m²

Mounted with Quick-click glides in plastic. Interchangeable glides in felt are included and delivered with each chair.
Stackable: 15 pcs. on trolley, 8 pcs. on floor.

Certifications

EU Ecolabel variants: Chrome or black powder-coated frame together with black shell, HR foam and upholstery in Omni leather 301 black, Connect, Remix or Re-wool fabric

FSC® certified

EN 1022:2005, EN 16139:2013 (L1)

Recommended upholstery

Fabric group 0	Connect
Fabric group 1	Grand Linen, Remix, Capture, Bardal, Re-wool, Linara, Natural Linen, Erik
Fabric group 2	Hallingdal, Barnum, Loop, Steelcut Trio, Fiord, Ruskin, Savoy
Fabric group 3	Divina Melange, Vidar, Sunniva, Harald, Foss, Clay
Fabric group 4	Sisu, Safire, Elle, Cotil
Fabric group 5	Grand Mohair, Gentle
Leather group 0	Vice
Leather group 1	Omni
Leather group 2	Primo
Leather group 3	Max
Leather group 4	Nubuck, Vegeta, Organic, Cera

Model 3078



Lynderup Accessories Coupling device

Black coupling device in plastic for Lynderup Chair. The device is interchangeable and can be added to a standard chair. When not in use, it can be flipped under the seat and remain on the chair until next use and when stacking the chair.

Order configuration

For model 3080
and 3081

15

**Model
3079**

Lynderup Accessories
Chair suspensions

Chair suspensions in black powder coated steel.

Order configuration

	No template	Template enclosed
Black	70	165

Model 1004

Pato / Lynderup Accessories Transport trolley



Transport trolley for the stackable chairs Lynderup, Pato Sledge and Pato 4-Leg.
Black powder coated steel.

Modeldetails

0,77 m³ Packaging dimensions:
24 kg / L: 90 cm W: 59 cm H: 102 cm
18 kg

Order configuration

Black	1.035
-------	-------

Model 3236

Mogensen 3236 Chair Seat upholstered



Designed by Børge Mogensen, 1956

Frame of solid wood and back of wood moulded in layers. Plywood core seat upholstered with CMHR or HR foam and covered in fabric or leather.

Modeldetails

0,28 m³ Packaging dimensions:
7,5 kg / 6 kg L: 50 cm W: 54 cm H: 83 cm

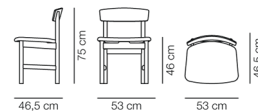

Essential Assortment

Item number	Upholstery	Wood	Price
323620351301	Leather Omni 301, Black	Oak soap, FSC Mix 70%	740
323622451301	Leather Omni 301, Black	Oak black lacquer, FSC Mix 70%	740

Essential variants only delivered with HR foam

Order configuration

	Oak black lacquered	Oak soap	Oak oiled	Oak light oil
Fabric group 1	895	815	920	920
Fabric group 2	940	855	965	965
Fabric group 3	995	905	1.015	1.015
Fabric group 4	1.070	970	1.080	1.080
Fabric group 5	1.120	1.020	1.130	1.130
C.O.M. fabric	895	815	920	920
Leather group 0	840	765	875	875
Leather group 1	905	825	930	930
Leather group 2	970	885	990	990
Leather group 3	1.060	965	1.070	1.070
Leather group 4	1.165	1.060	1.170	1.170
Leather group 5	1.340	1.220	1.325	1.325
C.O.M. leather	905	825	930	930

Fabric consumption: 0,6 m. Leather consumption: 0,67 m²

Extra charge for

QuickClick glides with or without felt (R3236): +24

Certifications

FSC® certified

Recommended upholstery

Fabric group 1	Grand Linen, Remix, Capture, Bardal, Re-wool, Natural Linen, Linara, Erik
Fabric group 2	Hallingdal, Barnum, Loop, Steelcut Trio, Fiord, Ruskin, Savoy
Fabric group 3	Divina Melange, Vidar, Sunniva, Harald, Foss, Clay
Fabric group 4	Cotil, Sisu, Elle, Safire
Fabric group 5	Grand Mohair, Gentle
Leather group 0	Vice
Leather group 1	Omni
Leather group 2	Primo
Leather group 3	Max
Leather group 4	Vegeta, Nubuck, Organic, Cera

Model 3171

The Mogensen Bench Seat upholstered



Designed by Børge Mogensen, 1956

Frame of solid wood. Back is made from a single piece of solid wood. Seat of plywood core generously upholstered with CMHR or HR foam and covered in fabric or leather.

Modeldetails

0,82 m³ Packaging dimensions:
23 kg / 21 kg L: 175 cm W: 59 cm H: 79 cm

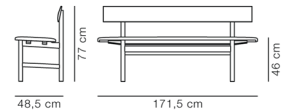

Essential Assortment

Item number	Upholstery	Wood	Price
317100651301	Leather Omni 301, Black	Oak black lacquered	3.010
317110551301	Leather Omni 301, Black	Oak oil	3.010
317110750095	Leather Max 95, Cognac	Oak light oil	3.375
317110951301	Leather Omni 301, Black	Smoked oak, oiled	3.375
317110350090	Leather Vegeta 90, Natural	Oak soap	3.615

Essential variants only delivered with HR foam

Order configuration

	Oak soap	Oak oiled	Oak light oil	Oak black lacquered	Smoked oak, oiled
Fabric group 1	3.045	3.085	3.045	3.350	3.505
Fabric group 2	3.180	3.215	3.180	3.495	3.655
Fabric group 3	3.345	3.385	3.345	3.680	3.845
Fabric group 4	3.555	3.590	3.555	3.910	4.085
Fabric group 5	3.730	3.770	3.730	4.105	4.290
C.O.M. fabric	3.045	3.085	3.045	3.350	3.505
Leather group 0	2.875	2.910	2.875	3.160	3.305
Leather group 1	3.090	3.125	3.090	3.400	3.555
Leather group 2	3.285	3.320	3.285	3.610	3.775
Leather group 3	3.535	3.575	3.535	3.890	4.070
Leather group 4	3.890	3.930	3.890	4.280	4.475
Leather group 5	4.475	4.515	4.475	4.925	5.145
C.O.M. leather	3.090	3.125	3.090	3.400	3.555

Fabric consumption: 1,8 m. Leather consumption: 2,5 m²

Extra charge for

QuickClick glides with or without felt (R3171): +24

Recommended upholstery

Fabric group 1	Grand Linen, Remix, Capture, Bardal, Re-wool, Natural Linen, Linara, Erik
Fabric group 2	Hallingdal, Barnum, Loop, Steelcut Trio, Fiord, Ruskin, Savoy
Fabric group 3	Divina Melange, Vidar, Sunniva, Harald, Foss, Clay
Fabric group 4	Cotil, Sisu, Elle, Safire
Fabric group 5	Grand Mohair, Gentle
Leather group 0	Vice
Leather group 1	Omni
Leather group 2	Primo
Leather group 3	Max
Leather group 4	Vegeta, Nubuck, Organic, Cera

Model 4200

Pato 4 Leg Chair Polypropylene seat



Designed by Welling / Ludvik, 2013

Stacking chair. Shell of 100% recycled coloured-through polypropylene. Frame of steel tube chromed or powder coated. Mounted with interchangeable plastic glides.

Modeldetails

0,48 m³ Packaging dimensions:
6,6 kg / 5 kg L: 59 cm W: 63 cm H: 95 cm



Essential Assortment

Item number	Shell	Frame	Price
42000740005	Quartz grey	Black	220
42001140005	White	Black	220
42001240005	Black	Black	220
42001540005	Ocean	Black	260
42001640005	Storm	Black	260
42001940005	Stone	Black	260
42002340005	Ancient green	Black	260
42002440005	Dark red	Black	260
42002540005	Dark grey	Black	260
42002740005	Sand	Black	260

Essential variants are delivered with plastic glides

Order configuration

	Black / White / Quartz grey Polypropylene	Other standard colours Polypropylene
Black	220	260
Chrome	265	265

Stackable: 25 pcs. on trolley, 18 pcs. on floor.

Extra charge for

Glides with felt:	+12
Other standard frame colours:	+30

Certifications

EU Ecolabel variant: Black powder-coated frame

EN 1021-1:2006 - Smouldering cigarette, EN 1021-2:2006 - Match flame equivalent, EN 1022:2005, EN 16139:2013 (L2)

Model 4202

Pato 4 Leg Chair Fully upholstered



Designed by Welling / Ludvik, 2013

Fully upholstered chair, stackable. Inner shell of 100% recycled polypropylene with CMHR or HR foam, covered in fabric or leather. Cover is non-removable. Frame of steel tube chromed or powder coated. Mounted with interchangeable plastic glides.

Modeldetails

0,36 m³ Packaging dimensions:
6,6 kg / 5 kg L: 58,5 cm W: 61 cm H: 94 cm

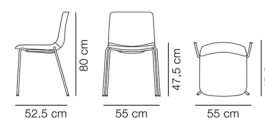

Essential Assortment

Item number	Upholstery	Frame	Price
42020130340005	Connect 60999	Black	435
42020746540005	Remix 123	Black	495
42021930040005	Re-Wool 198	Black	495
42021931140005	Re-Wool 128	Black	495
42025130140005	Leather Omni 301, Black	Black	600
42025130740005	Leather Omni 307, Cognac	Black	600

Essential variants are delivered with plastic glides and HR foam

Order configuration

Frame: Chrome or black.

Fabric group 0	525
Fabric group 1	550
Fabric group 2	605
Fabric group 3	670
Fabric group 4	750
Fabric group 5	830
C.O.M. fabric	550
Leather group 0	580
Leather group 1	620
Leather group 2	735
Leather group 3	885
Leather group 4	970
Leather group 5	1.115
C.O.M. leather	620

Fabric consumption: 0,62 m. Leather consumption: 1,3 m²

Stackable: 23 pcs. on trolley, 16 pcs. on floor.

Extra charge for

Glides with felt:	+12
Other standard frame colours:	+30

Certifications

EU Ecolabel variants: Black powder-coated frame together with HR foam and upholstery in Omni leather 301 black, Connect, Remix or Re-wool fabric
EN 1022:2005, EN 16139:2013 (L2)

Recommended upholstery

Fabric group 0	Connect
Fabric group 1	Grand Linen, Linara, Bardal, Capture, Remix, Re-wool, Natural Linen, Erik
Fabric group 2	Barnum, Hallingdal, Savoy, Steelcut Trio, Fiord, Ruskin, Loop
Fabric group 3	Harald, Vidar, Clay, Sunniva, Divina Melange, Foss
Fabric group 4	Sisu, Elle, Safire, Cotil
Fabric group 5	Gentle, Grand Mohair
Leather group 0	Vice
Leather group 1	Omni
Leather group 2	Primo
Leather group 3	Max
Leather group 4	Nubuck, Organic, Vegeta, Cera

Model 4210

Pato 4 Leg Armchair Polypropylene seat



Designed by Welling / Ludvik, 2013

Stacking chair with arms. Shell of 100% recycled coloured-through polypropylene. Arms of black powder coated aluminum. Frame of steel tube chromed or powder coated. Mounted with interchangeable plastic glides.

Modeldetails

0,48 m³ Packaging dimensions:
6,6 kg / L: 59 cm W: 63 cm H: 89 cm
5,9 kg



Order configuration

	Standard colours Polypropylene
Black	395
Chrome	395

Stackable: 18 pcs. on trolley, 13 pcs. on floor.

Extra charge for

Glides with felt:	+12
Other standard frame colours:	+37

Certifications

EN 1021-1:2006 - Smouldering cigarette, EN 1021-2:2006 - Match flame equivalent, EN 1022:2005, EN 16139:2013 (L2)

Model 4212

Pato 4 Leg Armchair Fully upholstered



Designed by Welling / Ludvik, 2013

Fully upholstered chair with arms, stackable. Inner shell of 100% recycled polypropylene with CMHR or HR foam, covered in fabric or leather. Cover is non-removable. Arms of black powder coated aluminum. Frame of steel tube chromed or powder coated. Mounted with interchangeable plastic glides.

Modeldetails

0,36 m³ Packaging dimensions:
8,1 kg / 6,6 kg L: 58,5 cm W: 61 cm H: 94 cm

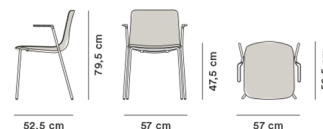

Essential Assortment

Item number	Upholstery	Frame	Price
4212013034000513	Connect 60999	Black	565
4212074654000513	Remix 123	Black	625
4212193004000513	Re-Wool 198	Black	625
4212193114000513	Re-Wool 128	Black	625
4212513014000513	Leather Omni 301, Black	Black	685
4212513074000513	Leather Omni 307, Cognac	Black	685

Essential variants are delivered with plastic glides and HR foam

Order configuration

Frame: Chrome or black.

Fabric group 0	655
Fabric group 1	690
Fabric group 2	740
Fabric group 3	810
Fabric group 4	895
Fabric group 5	985
C.O.M. fabric	690
Leather group 0	710
Leather group 1	760
Leather group 2	875
Leather group 3	1.025
Leather group 4	1.130
Leather group 5	1.300
C.O.M. leather	760

Fabric consumption: 0,62 m. Leather consumption: 1,3 m²

Stackable: 16 pcs. on trolley, 11 pcs. on floor.

Extra charge for

Glides with felt: +12
Other standard frame colours: +37

Certifications

EN 1022:2005, EN 16139:2013 (L2)

Recommended upholstery

Fabric group 0	Connect
Fabric group 1	Grand Linen, Linara, Bardal, Capture, Remix, Re-wool, Natural Linen, Erik
Fabric group 2	Barnum, Hallingdal, Savoy, Steelcut Trio, Fiord, Loop, Ruskin
Fabric group 3	Harald, Vidar, Clay, Sunniva, Divina Melange, Foss
Fabric group 4	Sisu, Elle, Safire, Cotil
Fabric group 5	Gentle, Grand Mohair
Leather group 0	Vice
Leather group 1	Omni
Leather group 2	Primo, Trace
Leather group 3	Max
Leather group 4	Nubuck, Organic, Vegeta, Cera

Model 4225

Pato Wood base Chair Polypropylene seat



Designed by Welling / Ludvik, 2016

Chair with solid wood legs. Shell of 100% recycled coloured-through polypropylene.

Modeldetails

0,4 m³

7 kg /
4,6 kg

Packaging dimensions:

L: 51,3 cm W: 56,1 cm H: 113,1 cm

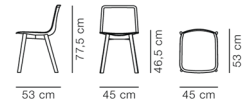

Order configuration

Frame: Oak lacquered, oak black lacquered or smoked oak stained, lacquered.

Standard
colours
Polypropylene

385

Extra charge for

QuickClick glides with or without felt:

+12

Certifications

FSC® certified

EN 1021-1:2006 - Smouldering cigarette, EN 1021-2:2006 - Match flame equivalent, EN 1022:2005, EN 16139:2013 (L2)

Model 4222

Pato Wood base Chair Fully upholstered



Designed by Welling / Ludvik, 2016

Fully upholstered chair with solid wood frame. Inner shell of 100% recycled polypropylene with CMHR or HR foam, covered in fabric or leather. Cover is non-removable.

Modeldetails

0,4 m³ Packaging dimensions:
7 kg / 5 kg L: 74 cm W: 61 cm H: 95 cm

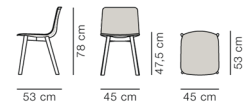

Essential Assortment

Item number	Upholstery	Frame	Price
422219300855000	Re-Wool 198	Smoked oak stained lacquer, FSC Mix 70%	625
422219311854000	Re-Wool 128	Oak lacquer, FSC Mix 70%	625
422251301855000	Leather Omni 301, Black	Smoked oak stained lacquer, FSC Mix 70%	685
422251307854000	Leather Omni 307, Cognac	Oak lacquer, FSC Mix 70%	685

Essential variants only delivered with HR foam

Order configuration

Frame: Oak lacquered, oak black lacquered or smoked oak stained, lacquered.

Fabric group 0	635
Fabric group 1	660
Fabric group 2	715
Fabric group 3	785
Fabric group 4	870
Fabric group 5	955
C.O.M. fabric	660
Leather group 0	685
Leather group 1	735
Leather group 2	850
Leather group 3	1.005
Leather group 4	1.105
Leather group 5	1.275
C.O.M. leather	735

Fabric consumption: 0,62 m. Leather consumption: 1,3 m²

Extra charge for

QuickClick glides with or without felt: +12

Certifications

FSC® certified
EN 1022:2005, EN 16139:2013 (L2)

Recommended upholstery

Fabric group 0	Connect
Fabric group 1	Grand Linen, Linara, Bardal, Capture, Remix, Re-wool, Natural Linen, Erik
Fabric group 2	Barnum, Hallingdal, Savoy, Steelcut Trio, Fiord, Ruskin, Loop
Fabric group 3	Harald, Vidar, Clay, Sunniva, Divina Melange, Foss
Fabric group 4	Sisu, Elle, Safire, Cotil
Fabric group 5	Gentle, Grand Mohair
Leather group 0	Vice
Leather group 1	Omni
Leather group 2	Primo, Trace
Leather group 3	Max
Leather group 4	Nubuck, Organic, Vegeta, Cera

Model 4100

Pato Sledge Chair Polypropylene seat



Designed by Welling / Ludvik, 2013

Stacking chair. Shell of 100% recycled coloured-through polypropylene. Frame of solid steel, chromed or powder coated. Mounted with interchangeable plastic glides.

Modeldetails

0,36 m³ Packaging dimensions:
7,5 kg / 6,2 kg L: 58 cm W: 64 cm H: 95 cm

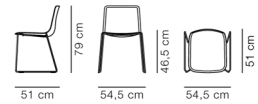

Essential Assortment

Item number	Shell	Frame	Price
41000740040	Quartz grey	Black	220
41001140040	White	Black	220
41001240040	Black	Black	220
41001540040	Ocean	Black	260
41001640040	Storm	Black	260
41001940040	Stone	Black	260
41002340040	Ancient green	Black	260
41002440040	Dark red	Black	260
41002540040	Dark grey	Black	260
41002740040	Sand	Black	260

Essential variants are delivered with plastic glides

Order configuration

	Black / White / Quartz grey Polypropylene	Other standard colours Polypropylene
Black	220	260
Chrome	265	265

Stackable: 25 pcs. on trolley, 18 pcs. on floor.
Suitable for outdoor use when frame is powder coated.

Extra charge for

Glides with felt:	+12
Other standard frame colours:	+30

Certifications

EU Ecolabel variant: Black powder-coated frame
EN 1021-1:2006 - Smouldering cigarette, EN 1021-2:2006 - Match flame equivalent, EN 1022:2005, EN 16139:2013 (L1)

Model 4102

Pato Sledge Chair Fully upholstered



Designed by Welling / Ludvik, 2013

Fully upholstered chair, stackable. Inner shell of 100% recycled polypropylene with CMHR or HR foam, covered in fabric or leather. Cover is non-removable. Frame of solid steel, chromed or powder coated. Mounted with interchangeable plastic glides.

Modeldetails

0,36 m³ Packaging dimensions:
8,5 kg / 7 kg L: 58,5 cm W: 61 cm H: 94 cm



Essential Assortment

Item number	Upholstery	Frame	Price
41020130340040	Connect 60999	Black	435
41020746540040	Remix 123	Black	495
41021930040040	Re-Wool 198	Black	495
41021931140040	Re-Wool 128	Black	495
41025130140040	Leather Omni 301, Black	Black	600
41025130740040	Leather Omni 307, Cognac	Black	600

Essential variants are delivered with plastic glides and HR foam

Order configuration

Frame: Chrome or black.

Fabric group 0	525
Fabric group 1	550
Fabric group 2	605
Fabric group 3	670
Fabric group 4	750
Fabric group 5	830
C.O.M. fabric	550
Leather group 0	580
Leather group 1	620
Leather group 2	735
Leather group 3	885
Leather group 4	970
Leather group 5	1.115
C.O.M. leather	620

Fabric consumption: 0,62 m. Leather consumption: 1,3 m²

Stackable: 23 pcs. on trolley, 16 pcs. on floor.

Extra charge for

Glides with felt:	+12
Other standard frame colours:	+30

Certifications

EU Ecolabel variants: Black powder-coated frame together with HR foam and upholstery in Omni leather 301 black, Connect, Remix or Re-wool fabric
EN 1022:2005, EN 16139:2013 (L1)

Recommended upholstery

Fabric group 0	Connect
Fabric group 1	Grand Linen, Linara, Bardal, Capture, Remix, Re-wool, Natural Linen, Erik
Fabric group 2	Barnum, Hallingdal, Savoy, Steelcut Trio, Fiord, Ruskin, Loop
Fabric group 3	Harald, Vidar, Clay, Sunniva, Divina Melange, Foss
Fabric group 4	Sisu, Elle, Safire, Cotil
Fabric group 5	Gentle, Grand Mohair
Leather group 0	Vice
Leather group 1	Omni
Leather group 2	Primo, Trace
Leather group 3	Max
Leather group 4	Nubuck, Organic, Vegeta, Cera

Model 4110

Pato Sledge Armchair Polypropylene seat



Designed by Welling / Ludvik, 2013

Stacking chair with arms. Shell of 100% recycled coloured-through polypropylene. Frame of solid steel, chromed or powder coated. Mounted with interchangeable plastic glides.

Modeldetails

0,36 m³ Packaging dimensions:
8,3 kg / 6,8 kg L: 58,5 cm W: 61 cm H: 94 cm



Order configuration

	Standard colours Polypropylene
Black	395
Chrome	395

Stackable: 18 pcs. on trolley, 13 pcs. on floor.

Extra charge for

Glides with felt:	+12
Other standard frame colours:	+37

Certifications

EN 1021-1:2006 - Smouldering cigarette, EN 1021-2:2006 - Match flame equivalent, EN 16139:2013 (L1)

Model 4112

Pato Sledge Armchair Fully upholstered



Designed by Welling / Ludvik, 2013

Fully upholstered chair with arms, stackable. Inner shell of 100% recycled polypropylene with CMHR or HR foam, covered in fabric or leather. Cover is non-removable. Frame of solid steel, chromed or powder coated. Mounted with interchangeable plastic glides.

Modeldetails

0,36 m³ Packaging dimensions:
9,3 kg / 7,8 kg L: 58,5 cm W: 61 cm H: 94 cm

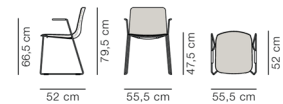

Essential Assortment

Item number	Upholstery	Frame	Price
4112013034004012	Connect 60999	Black	565
4112074654004012	Remix 123	Black	625
4112193004004012	Re-Wool 198	Black	625
4112193114004012	Re-Wool 128	Black	625
4112513014004012	Leather Omni 301, Black	Black	685
4112513074004012	Leather Omni 307, Cognac	Black	685

Essential variants are delivered with plastic glides and HR foam

Order configuration

Frame: Chrome or black.

Fabric group 0	655
Fabric group 1	685
Fabric group 2	740
Fabric group 3	805
Fabric group 4	890
Fabric group 5	980
C.O.M. fabric	685
Leather group 0	705
Leather group 1	760
Leather group 2	875
Leather group 3	1.025
Leather group 4	1.130
Leather group 5	1.295
C.O.M. leather	760

Fabric consumption: 0,62 m. Leather consumption: 1,3 m²

Stackable: 16 pcs. on trolley, 11 pcs. on floor.

Extra charge for

Glides with felt: +12
Other standard frame colours: +37

Certifications

EN 16139:2013 (L1)

Recommended upholstery

Fabric group 0	Connect
Fabric group 1	Grand Linen, Linara, Bardal, Capture, Remix, Re-wool, Natural Linen, Erik
Fabric group 2	Barnum, Hallingdal, Savoy, Steelcut Trio, Fiord, Ruskin, Loop
Fabric group 3	Harald, Vidar, Clay, Sunniva, Divina Melange, Foss
Fabric group 4	Sisu, Elle, Safire, Cotil
Fabric group 5	Gentle, Grand Mohair
Leather group 0	Vice
Leather group 1	Omni
Leather group 2	Primo, Trace
Leather group 3	Max
Leather group 4	Nubuck, Organic, Vegeta, Cera

Model 4300



Pato Sledge Barstool Polypropylene seat

Designed by Welling / Ludvik, 2013

Barstool. Shell of 100% recycled coloured-through polypropylene. Frame of solid steel, chromed or powder coated. Mounted with interchangeable plastic glides. Please specify bar or counter height.

Modeldetails

0,34 m³

Packaging dimensions:

8 kg /
7,5 kg

L: 57 cm W: 52 cm H: 115 cm

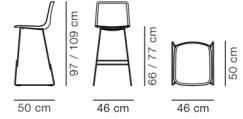

Order configuration

Bar or counter height.

	Standard colours Polypropylene
Black	340
Chrome	340

Extra charge for

Glides with felt:	+12
Other standard frame colours:	+46

Certifications

EN 1021-1:2006 - Smouldering cigarette, EN 1021-2:2006 - Match flame equivalent, EN 1022:2005, EN 16139:2013 (L2)

Model 4302



Pato Sledge Barstool Fully upholstered

Designed by Welling / Ludvik, 2013

Fully upholstered barstool. Inner shell of 100% recycled polypropylene with CMHR or HR foam, covered in fabric or leather. Cover is non-removable. Frame of solid steel, chromed or powder coated. Mounted with interchangeable plastic glides. Please specify bar or counter height.

Modeldetails

0,34 m³ Packaging dimensions:
9 kg / 8 kg L: 57 cm W: 53 cm H: 107 cm

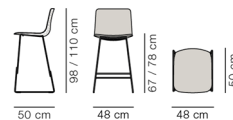

Order configuration

Frame: Chrome or black.
Bar or counter height.

Fabric group 0	615
Fabric group 1	645
Fabric group 2	700
Fabric group 3	765
Fabric group 4	850
Fabric group 5	935
C.O.M. fabric	645
Leather group 0	665
Leather group 1	715
Leather group 2	830
Leather group 3	985
Leather group 4	1.080
Leather group 5	1.245
C.O.M. leather	715

Fabric consumption: 0,62 m. Leather consumption: 1,3 m²

Extra charge for

Glides with felt: +12
Other standard frame colours: +46

Certifications

EN 1022:2005, EN 16139:2013 (L2)

Recommended upholstery

Fabric group 0	Connect
Fabric group 1	Grand Linen, Linara, Bardal, Capture, Remix, Re-wool, Natural Linen, Erik
Fabric group 2	Barnum, Hallingdal, Savoy, Steelcut Trio, Fiord, Ruskin, Loop
Fabric group 3	Harald, Vidar, Clay, Sunniva, Divina Melange, Foss
Fabric group 4	Sisu, Elle, Safire, Cotil
Fabric group 5	Gentle, Grand Mohair
Leather group 0	Vice
Leather group 1	Omni
Leather group 2	Primo, Trace
Leather group 3	Max
Leather group 4	Nubuck, Organic, Vegeta, Cera

Model 4312

Pato Sledge Stool Fully upholstered

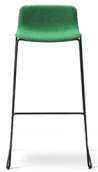

Designed by Welling / Ludvik, 2016

Fully upholstered barstool, stackable. Inner shell of 100% recycled polypropylene with CMHR or HR foam, covered in fabric or leather. Cover is non-removable. Frame of solid steel, chromed or powder coated. Mounted with interchangeable plastic glides. Please specify bar or counter height.

Modeldetails

0,32 m³ Packaging dimensions:
8,5 kg / 6,4 kg L: 51,5 cm W: 56 cm H: 113 cm

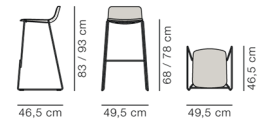

Essential Assortment

Item number	Upholstery	Frame	Height	Price
43120130340040780	Connect 60999	Black	Sh 78 cm	530
43120746540040780	Remix 123	Black	Sh 78 cm	530
43121930040040780	Re-Wool 198	Black	Sh 78 cm	530
43121931140040780	Re-Wool 128	Black	Sh 78 cm	530
43125130140040780	Leather Omni 301, Black	Black	Sh 78 cm	660
43125130740040780	Leather Omni 307, Cognac	Black	Sh 78 cm	660

Essential variants are delivered with plastic glides and HR foam

Order configuration

Frame: Chrome or black.
Bar or counter height.

Fabric group 0	600
Fabric group 1	635
Fabric group 2	690
Fabric group 3	755
Fabric group 4	840
Fabric group 5	925
C.O.M. fabric	635
Leather group 0	660
Leather group 1	705
Leather group 2	825
Leather group 3	975
Leather group 4	1.075
Leather group 5	1.235
C.O.M. leather	705

Fabric consumption: 0,5 m. Leather consumption: 1,12 m²

Stackable: 12 pcs. on floor.

Extra charge for

Glides with felt: +12
Other standard frame colours: +46

Certifications

EN 1022:2005, EN 16139:2013 (L2)

Recommended upholstery

Fabric group 0	Connect
Fabric group 1	Grand Linen, Linara, Bardal, Capture, Remix, Re-wool, Natural Linen, Erik
Fabric group 2	Barnum, Hallingdal, Savoy, Steelcut Trio, Fiord, Ruskin, Loop
Fabric group 3	Harald, Vidar, Clay, Sunniva, Divina Melange, Foss
Fabric group 4	Sisu, Elle, Safire, Cotil
Fabric group 5	Gentle, Grand Mohair
Leather group 0	Vice
Leather group 1	Omni
Leather group 2	Primo, Trace
Leather group 3	Max
Leather group 4	Nubuck, Organic, Vegeta, Cera

Model 4002

Pato Swivel Chair Fully upholstered



Designed by Welling / Ludvik, 2014

Fully upholstered swivel chair. Inner shell of 100% recycled polypropylene with CMHR or HR foam, covered in fabric or leather. Cover is non-removable. 4-star aluminum base, polished or powder coated. Mounted with plastic glides.

Modeldetails

0,25 m³ Packaging dimensions:
12 kg / 8,9 kg L: 51,3 cm W: 56,1 cm H: 113,1 cm

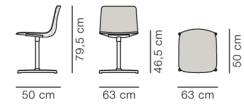

Order configuration

Frame: Polished aluminium or black.

Fabric group 0	550
Fabric group 1	570
Fabric group 2	615
Fabric group 3	685
Fabric group 4	720
Fabric group 5	800
C.O.M. fabric	570
Leather group 0	680
Leather group 1	720
Leather group 2	765
Leather group 3	830
Leather group 4	930
Leather group 5	1.080
C.O.M. leather	720

Fabric consumption: 0,62 m. Leather consumption: 1,3 m²

Other frame colours by quotation (min. 25 pcs.).

Glides with felt: +12
Castors, chrome or black: +26

Certifications

EN 1022:2005, EN 16139:2013 (L1)

Recommended upholstery

Fabric group 0	Connect
Fabric group 1	Grand Linen, Linara, Bardal, Capture, Remix, Natural Linen, Re-wool
Fabric group 2	Hallingdal, Savoy, Barnum, Steelcut Trio, Fiord, Ruskin, Loop
Fabric group 3	Harald, Vidar, Clay, Sunniva, Divina Melange, Foss
Fabric group 4	Sisu, Elle, Safire, Cotil
Fabric group 5	Gentle, Grand Mohair
Leather group 0	Vice
Leather group 1	Omni
Leather group 2	Primo, Trace
Leather group 3	Max
Leather group 4	Nubuck, Vegeta, Organic, Cera

Model 4012

Pato Swivel Armchair Fully upholstered



Designed by Welling / Ludvik, 2014

Fully upholstered swivel chair with arms. Inner shell of 100% recycled polypropylene with CMHR or HR foam, covered in fabric or leather. Cover is non-removable. 4-star aluminum base, polished or powder coated. Mounted with plastic glides.

Modeldetails

0,48 m³ Packaging dimensions:
13 kg / L: 64,5 cm W: 71,5 cm H: 104 cm
10,6 kg

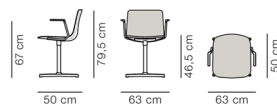

Order configuration

Frame: Polished aluminium or black.

Fabric group 0	665
Fabric group 1	680
Fabric group 2	725
Fabric group 3	800
Fabric group 4	835
Fabric group 5	910
C.O.M. fabric	680
Leather group 0	790
Leather group 1	835
Leather group 2	875
Leather group 3	940
Leather group 4	1.030
Leather group 5	1.190
C.O.M. leather	835

Fabric consumption: 0,62 m. Leather consumption: 1,3 m²

Other frame colours by quotation (min. 25 pcs.).

Extra charge for

Glides with felt:	+12
Castors, chrome or black:	+26

Recommended upholstery

Fabric group 0	Connect
Fabric group 1	Grand Linen, Linara, Capture, Remix, Natural Linen, Re-wool, Erik
Fabric group 2	Hallingdal, Savoy, Barnum, Steelcut Trio, Fiord, Ruskin, Loop
Fabric group 3	Harald, Vidar, Clay, Sunniva, Divina Melange, Foss
Fabric group 4	Sisu, Elle, Safire, Cotil
Fabric group 5	Gentle, Grand Mohair
Leather group 0	Vice
Leather group 1	Omni
Leather group 2	Primo, Trace
Leather group 3	Max
Leather group 4	Nubuck, Vegeta, Organic, Cera

Model 4022

Pato Office Chair Fully upholstered



Designed by Welling / Ludvik, 2014

Fully upholstered height-adjustable swivel chair. Inner shell of 100% recycled polypropylene with CMHR or HR foam, covered in fabric or leather. Cover is non-removable. 5-star base with castors, aluminum polished or powder coated.

Modeldetails

0,42 m³ Packaging dimensions:
13 kg / L: 69 cm W: 69 cm H: 88 cm
10,3 kg

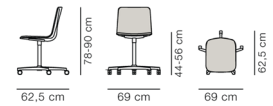

Order configuration

Frame: Polished aluminum or black.

Fabric group 0	605
Fabric group 1	625
Fabric group 2	670
Fabric group 3	745
Fabric group 4	780
Fabric group 5	865
C.O.M. fabric	625
Leather group 0	740
Leather group 1	785
Leather group 2	830
Leather group 3	900
Leather group 4	995
Leather group 5	1.165
C.O.M. leather	785

Fabric consumption: 0,62 m. Leather consumption: 1,3 m²

Other frame colours by quotation (min. 25 pcs.).

Certifications

EN 1022:2005, EN 16139:2013 (L1)

Recommended upholstery

Fabric group 0	Connect
Fabric group 1	Grand Linen, Linara, Bardal, Capture, Remix, Re-wool, Natural Linen, Erik
Fabric group 2	Barnum, Hallingdal, Savoy, Steelcut Trio, Fiord, Ruskin, Loop
Fabric group 3	Harald, Vidar, Clay, Sunniva, Divina Melange, Foss
Fabric group 4	Sisu, Elle, Safire, Cotil
Fabric group 5	Gentle, Grand Mohair
Leather group 0	Vice
Leather group 1	Omni
Leather group 2	Primo, Trace
Leather group 3	Max
Leather group 4	Nubuck, Organic, Vegeta, Cera

Model 4032

Pato Office Armchair Fully upholstered



Designed by Welling / Ludvik, 2014

Fully upholstered height-adjustable swivel chair with arms. Inner shell of 100% recycled polypropylene with CMHR or HR foam, covered in fabric or leather. Cover is non-removable. 5-star aluminum base with castors, polished or powder coated.

Modeldetails

0,42 m³ Packaging dimensions:
13 kg / L: 69 cm W: 69 cm H: 88 cm
10,3 kg

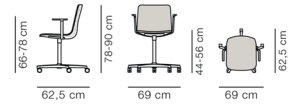

Order configuration

Frame: Polished aluminium or black.

Fabric group 0	720
Fabric group 1	740
Fabric group 2	785
Fabric group 3	860
Fabric group 4	895
Fabric group 5	980
C.O.M. fabric	740
Leather group 0	855
Leather group 1	900
Leather group 2	945
Leather group 3	1.015
Leather group 4	1.115
Leather group 5	1.285
C.O.M. leather	900

Fabric consumption: 0,62 m. Leather consumption: 1,3 m²

Other frame colours by quotation (min. 25 pcs.).

Recommended upholstery

Fabric group 0	Connect
Fabric group 1	Grand Linen, Linara, Bardal, Capture, Remix, Natural Linen, Re-wool
Fabric group 2	Hallingdal, Savoy, Barnum, Steelcut Trio, Fiord, Ruskin, Loop
Fabric group 3	Harald, Vidar, Clay, Sunniva, Divina Melange, Foss
Fabric group 4	Sisu, Elle, Safire, Cotil
Fabric group 5	Gentle, Grand Mohair
Leather group 0	Vice
Leather group 1	Omni
Leather group 2	Primo, Trace
Leather group 3	Max
Leather group 4	Nubuck, Vegeta, Organic, Cera

Model 4052



Pato Executive Armchair Swivel base

Designed by Welling / Ludvik, 2015

Fully upholstered swivel chair with arms. Inner shell of plywood with CMHR or HR foam, covered in fabric or leather. Cover is non-removable. 4-star aluminum base, polished or powder coated. Mounted with plastic glides.

Modeldetails

0,48 m³ Packaging dimensions:
12 kg / L: 58,5 cm W: 63,5 cm H: 89 cm
10,5 kg

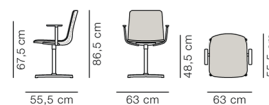

Order configuration

Frame: Polished aluminium or black.

Fabric group 0	795
Fabric group 1	825
Fabric group 2	880
Fabric group 3	965
Fabric group 4	1.015
Fabric group 5	1.135
C.O.M. fabric	825
Leather group 0	995
Leather group 1	1.080
Leather group 2	1.155
Leather group 3	1.280
Leather group 4	1.445
Leather group 5	1.735
C.O.M. leather	1.080

Fabric consumption: 0,9 m. Leather consumption: 2,3 m²

Other frame colours by quotation (min. 25 pcs.).

Extra charge for

Glides with felt:	+12
Castors, chrome or black	+26

Certifications

FSC® certified
EN 1022:2005, EN 16139:2013 (L1)

Recommended upholstery

Fabric group 0	Connect
Fabric group 1	Grand Linen, Linara, Bardal, Capture, Remix, Re-wool, Natural Linen, Erik
Fabric group 2	Barnum, Hallingdal, Savoy, Steelcut Trio, Fiord, Ruskin, Loop
Fabric group 3	Harald, Vidar, Clay, Sunniva, Divina Melange, Foss
Fabric group 4	Sisu, Elle, Safire, Cotil
Fabric group 5	Gentle, Grand Mohair
Leather group 0	Vice
Leather group 1	Omni
Leather group 2	Primo, Trace
Leather group 3	Max
Leather group 4	Nubuck, Organic, Vegeta, Cera

Model 4072



Pato Executive Armchair

Height adjustable swivel base

Designed by Welling / Ludvik, 2015

Fully upholstered height-adjustable swivel chair with arms. Inner shell of plywood with CMHR or HR foam, covered in fabric or leather. Cover is non-removable. 5-star base with castors, aluminum polished or powder coated. Please note chair cannot be delivered with glides instead of castors due to the gas lift.

Modeldetails

0,4 m³ Packaging dimensions:
14 kg / L: 64 cm W: 71 cm H: 104 cm
11,9 kg

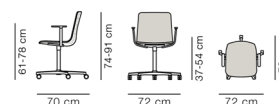

Order configuration

Frame: Polished aluminium or black.

Fabric group 0	860
Fabric group 1	890
Fabric group 2	950
Fabric group 3	1.040
Fabric group 4	1.095
Fabric group 5	1.230
C.O.M. fabric	890
Leather group 0	1.080
Leather group 1	1.170
Leather group 2	1.260
Leather group 3	1.395
Leather group 4	1.585
Leather group 5	1.910
C.O.M. leather	1.170

Fabric consumption: 0,9 m. Leather consumption: 2,3 m²

Other frame colours by quotation (min. 25 pcs.).

Certifications

FSC® certified

EN 1022:2005, EN 16139:2013 (L1)

Recommended upholstery

Fabric group 0	Connect
Fabric group 1	Grand Linen, Linara, Bardal, Capture, Remix, Re-wool, Natural Linen, Erik
Fabric group 2	Barnum, Hallingdal, Savoy, Steelcut Trio, Fiord, Ruskin, Loop
Fabric group 3	Harald, Vidar, Clay, Sunniva, Divina Melange, Foss
Fabric group 4	Sisu, Elle, Safire, Cotil
Fabric group 5	Gentle, Grand Mohair
Leather group 0	Vice
Leather group 1	Omni
Leather group 2	Primo, Trace
Leather group 3	Max
Leather group 4	Nubuck, Organic, Vegeta, Cera

Model 1004

Pato / Lynderup Accessories Transport trolley



Transport trolley for the stackable chairs Lynderup, Pato Sledge and Pato 4-Leg.
Black powder coated steel.

Modeldetails

0,77 m³ Packaging dimensions:
24 kg / L: 90 cm W: 59 cm H: 102 cm
18 kg

Order configuration

Black	1.035
-------	-------

**Model
1068**

Pato Accessories
Chair suspensions for barstool

Chair suspensions in black powder coated steel.

Order configuration

	No template	Template enclosed
Black	85	205

**Model
1069**

Pato Accessories
Chair suspensions for chair

Chair suspensions in black powder coated steel.

Order configuration

	No template	Template enclosed
Black	85	205

Model 6830

Pioneer Stool, ht 46 cm



Designed by Maria Bruun, 2023

Stackable stool with a base in solid wood. Seat consists of an inner construction of a MDF core with HR or CMHR foam and upholstered with a removable fabric cover with zippers or non-removable cover in leather. Upholstered seat is removable. Metal screws and fittings. Mounted with plastic glides, felt glides are available.

Modeldetails

0,09 m³ Packaging dimensions:
7 kg / 4 kg L: 42 cm W: 42 cm H: 50 cm

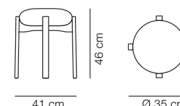

Essential Assortment

Item number	Upholstery	Frame	Price
6830002070854400	Hallingdal 200	Oak lacquer, FSC Mix 70%	590
6830002220855400	Hallingdal 370	Smoked oak stained lacquer, FSC Mix 70%	650
6830020390854400	Zero 0001	Oak lacquer, FSC Mix 70%	705
6830406280855400	Vidar 386	Smoked oak stained lacquer, FSC Mix 70%	705
6830508610855400	Leather Primo 86-1, Dark brown	Smoked oak stained lacquer, FSC Mix 70%	705
6830500900854400	Leather Vegeta 90, Natural	Oak lacquer, FSC Mix 70%	765

Essential variants are delivered with plastic glides and HR foam

Order configuration

	Beech black lacquered	Oak lacquered	Smoked oak stained, lacquered
Fabric group 1	590	650	705
Fabric group 2	620	680	735
Fabric group 3	645	705	760
Fabric group 4	690	755	810
Fabric group 5	785	845	905
C.O.M. fabric	590	650	705
Leather group 1	640	700	755
Leather group 2	665	725	780
Leather group 3	670	730	780
Leather group 4	725	780	835
Leather group 5	815	875	930
C.O.M. leather	640	700	755

Fabric consumption: 0,5 m. Leather consumption: 0,5 m²

Stackable: 6 pcs. on floor.

Certifications

FSC® certified

EN 1022:2005, EN 16139:2013 (L2)

Recommended upholstery

Fabric group 1	Linara, Bardal, Capture, Re-wool, Erik
Fabric group 2	Hallingdal, Barnum, Steelcut Trio, Fiord, Loop, Ruskin
Fabric group 3	Vidar, Clay, Sunniva, Divina Melange, Foss
Fabric group 4	Elle, Safire
Fabric group 5	Gentle
Leather group 1	Omni
Leather group 2	Primo, Trace
Leather group 3	Max
Leather group 4	Nubuck, Vegeta, Organic

Model 6831



Pioneer Stool, ht. 67 or 77 cm

Designed by Maria Bruun, 2023

Stool in two optional heights with a base in solid wood and footrest in plywood. Seat consists of an inner construction of a MDF core with HR or CMHR foam and upholstered with a removable fabric cover with zippers or non-removable cover in leather. Upholstered seat is removable. Metal screws and fittings. Mounted with plastic glides, felt glides are available. Please specify counter- or bar height.

Modeldetails

0,15 m³ Packaging dimensions:
8,5 kg / 5,5 kg L: 42 cm W: 42 cm H: 82 cm

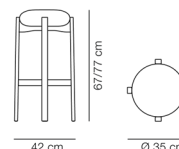

Essential Assortment

Item number	Upholstery	Frame	Height	Price
68310020708540177400	Hallingdal 200	Oak lacquer, FSC Mix 70%	Sh 77 cm	825
68310022208550177400	Hallingdal 370	Smoked oak stained lacquer, FSC Mix 70%	Sh 77 cm	885
68310203908540177400	Zero 0001	Oak lacquer, FSC Mix 70%	Sh 77 cm	945
68314062808550177400	Vidar 386	Smoked oak stained lacquer, FSC Mix 70%	Sh 77 cm	945
68315086108550177400	Leather Primo 86-1, Dark brown	Smoked oak stained lacquer, FSC Mix 70%	Sh 77 cm	945
68315009008540177400	Leather Vegeta 90, Natural	Oak lacquer, FSC Mix 70%	Sh 77 cm	965

Essential variants are delivered with plastic glides, HR foam and bar height

Order configuration

Bar or counter height.

	Beech black lacquered	Oak lacquered	Smoked oak stained, lacquered
Fabric group 1	765	885	945
Fabric group 2	795	915	970
Fabric group 3	820	940	1.000
Fabric group 4	865	990	1.045
Fabric group 5	955	1.085	1.135
C.O.M. fabric	765	885	945
Leather group 1	815	935	995
Leather group 2	830	950	1.000
Leather group 3	835	960	1.015
Leather group 4	885	1.005	1.055
Leather group 5	975	1.100	1.145
C.O.M. leather	815	935	995

Fabric consumption: 0,5 m. Leather consumption: 0,5 m²

Certifications

FSC® certified
EN 1022:2005, EN 16139:2013 (L2)

Recommended upholstery

Fabric group 1	Linara, Bardal, Capture, Re-wool, Erik
Fabric group 2	Hallingdal, Barnum, Steelcut Trio, Fiord, Loop, Ruskin
Fabric group 3	Vidar, Clay, Sunniva, Divina Melange, Foss
Fabric group 4	Elle, Safire
Fabric group 5	Gentle
Leather group 1	Omni
Leather group 2	Primo, Trace
Leather group 3	Max
Leather group 4	Nubuck, Vegeta, Organic

Model 3418



Plan Armchair Fully upholstered

Designed by Edward Barber & Jay Osgerby, 2024

Fully upholstered chair with frame in tubular steel, powder coated or brushed steel. Inner backrest frame in steel with moulded foam and inner seat in plywood with CMHR or HR foam covered in fabric or leather. Mounted with plastic glides. Felt glides available.

Model details

0,185 m³ Packaging dimensions:
9 kg / 7,5 kg L: 65 cm W: 57 cm H: 101 cm

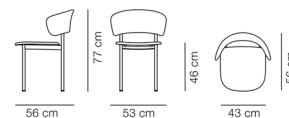

Essential Assortment

Item number	Upholstery	Frame	Price
3418400193000561	Re-Wool 198	Black	610
3418537041420561	Steelcut Quartet 924	Modernist green	610
3418538041400561	Steelcut Quartet 554	Bordeaux	610
3418500193110561	Re-Wool 128	Brushed steel	670
3418400513010561	Leather Omni 301, Black	Black	730
3418400500950561	Leather Max 95, Cognac	Black	790
3418500513010561	Leather Omni 301, Black	Brushed steel	790
3418500500950561	Leather Max 95, Cognac	Brushed steel	860

Essential variants are delivered with plastic glides and HR foam

Order configuration

Frame: Brushed Steel or standard colours: Black, Modernist green, Bordeaux

	Standard colours	Brushed Steel
Fabric group 0	680	745
Fabric group 1	685	755
Fabric group 2	715	785
Fabric group 3	745	815
Fabric group 4	800	870
Fabric group 5	860	930
C.O.M. fabric	685	755
Leather group 0	740	815
Leather group 1	765	840
Leather group 2	790	870
Leather group 3	805	880
Leather group 4	835	915
Leather group 5	905	980
C.O.M. leather	765	840

Fabric consumption: 1,1 m. Leather consumption: 1,1 m²

Spare parts: Glides with or without felt (R3412G)

Certifications

EU Ecolabel variants: Brushed Steel, Modernist Green, Bordeaux or black powder-coated frame together with HR foam and upholstery in Omni leather, Connect, Remix, Re-wool or Steelcut Quartet fabric

FSC® certified

ANSI/BIFMA X5.4-2020, EN 1022:2005, EN 16139:2013 (L2)

Recommended upholstery

Fabric group 0	Connect
Fabric group 1	Erik, Linara, Bardal, Capture, Remix, Natural Linen, Re-wool
Fabric group 2	Hallingdal, Barnum, Steelcut Trio, Fiord, Ruskin, Loop
Fabric group 3	Vidar, Clay, Sunniva, Divina Melange, Foss
Fabric group 4	Sisu, Elle, Safire
Fabric group 5	Gentle
Leather group 0	Vice
Leather group 1	Omni
Leather group 2	Primo, Trace
Leather group 3	Max
Leather group 4	Nubuck, Vegeta, Organic, Cera

Model 3438



Plan Arm Barstool Fully upholstered

Designed by Edward Barber & Jay Osgerby, 2024

Fully upholstered barstool with frame in tubular steel, powder coated or brushed steel. Inner backrest frame in steel with moulded foam and inner seat in plywood with CMHR or HR foam covered in fabric or leather. Mounted with plastic glides. Felt glides available. Please specify bar or counter height.

Model details

0,39 m³ Packaging dimensions:
13 kg / 10 kg L: 58 cm W: 58 cm H: 115 cm

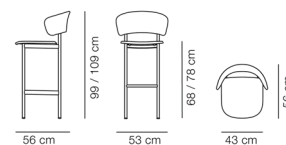

Essential Assortment

Item number	Upholstery	Frame	Height	Price
343840019300078561	Re-Wool 198	Black	Sh 78 cm	825
343853704142078561	Steelcut Quartet 924	Modernist green	Sh 78 cm	825
343853804140078561	Steelcut Quartet 554	Bordeaux	Sh 78 cm	825
343840051301078561	Leather Omni 301, Black	Black	Sh 78 cm	1.005
343840050095078561	Leather Max 95, Cognac	Black	Sh 78 cm	1.060
343850019311078561	Re-Wool 128	Brushed steel	Sh 78 cm	1.060
343850051301078561	Leather Omni 301, Black	Brushed steel	Sh 78 cm	1.180
343850050095078561	Leather Max 95, Cognac	Brushed steel	Sh 78 cm	1.240

Essential variants are delivered with plastic glides, HR foam and bar height

Order configuration

Frame: Brushed Steel or standard colours: Black, Modernist green, Bordeaux
Bar or counter height.

	Standard colours	Brushed Steel
Fabric group 0	890	1.100
Fabric group 1	1.020	1.235
Fabric group 2	1.080	1.290
Fabric group 3	1.135	1.345
Fabric group 4	1.235	1.445
Fabric group 5	1.420	1.625
C.O.M. fabric	1.020	1.235
Leather group 0	1.020	1.230
Leather group 1	1.075	1.285
Leather group 2	1.125	1.335
Leather group 3	1.155	1.350
Leather group 4	1.265	1.460
Leather group 5	1.455	1.645
C.O.M. leather	1.075	1.285

Fabric consumption: 1,1 m. Leather consumption: 1,1 m²

Spare parts: Glides with or without felt (R3412G)

Certifications

EU Ecolabel variants: Brushed Steel, Modernist Green, Bordeaux or black powder-coated frame together with HR foam and upholstery in Omni leather, Connect, Remix, Re-wool or Steelcut Quartet fabric

FSC® certified

ANSI/BIFMA X5.4-2020, EN 1022:2005, EN 16139:2013 (L2)

Recommended upholstery

Fabric group 0	Connect
Fabric group 1	Erik, Linara, Bardal, Capture, Remix, Natural Linen, Re-wool
Fabric group 2	Hallingdal, Barnum, Steelcut Trio, Fiord, Ruskin, Loop
Fabric group 3	Vidar, Clay, Sunniva, Divina Melange, Foss
Fabric group 4	Sisu, Elle, Safire
Fabric group 5	Gentle
Leather group 0	Vice
Leather group 1	Omni
Leather group 2	Primo, Trace
Leather group 3	Max
Leather group 4	Nubuck, Vegeta, Organic, Cera

Model 3412



Plan Chair Wooden seat

Designed by Edward Barber & Jay Osgerby, 2022

Chair with steel frame and plywood veneer seat and back finished with water-based lacquer. Frame is powder coated tubular steel mounted with plastic glides. Felt glides available.

Modeldetails

0,28 m³ Packaging dimensions:
8,2 kg / L: 46 cm W: 60 cm H: 100 cm
6,8 kg

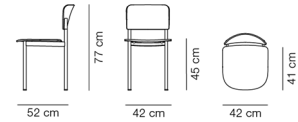

Essential Assortment

Item number	Wood	Frame	Price
341240020256	Oak lacquer FSC Mix 70%	Black	350
341240022356	Black ash, FSC Mix 70%	Black	350

Essential variants are delivered with plastic glides

Order configuration

	Oak lacquered	Black ash
Black	350	350
Modernist green	410	410
Bordeaux	410	410

Spare parts: Glides with or without felt (R3412G)

Certifications

EU Ecolabel
FSC® certified
ANSI/BIFMA X5.4-2020

Model 3413



Plan Chair Seat upholstered

Designed by Edward Barber & Jay Osgerby, 2022

Chair with steel frame, fully upholstered seat, plywood veneer back finished with water-based lacquer. Inner seat in plywood with CMHR or HR foam covered in fabric or leather.
Frame is powder coated tubular steel mounted with plastic glides. Felt glides available.

Modeldetails

0,28 m³ Packaging dimensions:
8,2 kg / 6,7 kg L: 46 cm W: 60 cm H: 100 cm

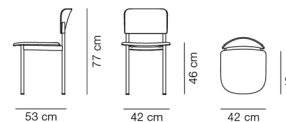

Essential Assortment

Item number	Upholstery	Wood	Frame	Price
341340020219311056	Re-Wool 128	Oak lacquer FSC Mix 70%	Black	445
341340022319300056	Re-Wool 198	Black ash, FSC Mix 70%	Black	445
341340022351301056	Leather Omni 301, Black	Black ash, FSC Mix 70%	Black	505

Essential variants are delivered with plastic glides and HR foam

Order configuration

Frame: Black, Modernist green or Bordeaux.

	Oak lacquered	Black ash
Fabric group 0	495	495
Fabric group 1	505	505
Fabric group 2	535	535
Fabric group 3	565	565
Fabric group 4	620	620
Fabric group 5	685	685
C.O.M. fabric	505	505
Leather group 0	515	515
Leather group 1	555	555
Leather group 2	575	575
Leather group 3	590	590
Leather group 4	625	625
Leather group 5	695	695
C.O.M. leather	555	555

Fabric consumption: 0,6 m. Leather consumption: 0,7 m²

Spare parts: Glides with or without felt (R3412G)

Certifications

EU Ecolabel variants: Modernist Green, Bordeaux or black powder-coated frame together with HR foam and upholstery in Omni leather, Connect, Remix, Re-wool or Steelcut Quartet fabric

FSC® certified

ANSI/BIFMA X5.4-2020

Recommended upholstery

Fabric group 0	Connect
Fabric group 1	Linara, Bardal, Capture, Remix, Natural Linen, Re-wool, Grand Linen, Erik
Fabric group 2	Hallingdal, Savoy, Barnum, Steelcut Trio, Fiord, Ruskin, Loop
Fabric group 3	Harald, Vidar, Clay, Sunniva, Divina Melange, Foss
Fabric group 4	Elle, Safire, Sisu
Fabric group 5	Gentle, Grand Mohair
Leather group 0	Vice
Leather group 1	Omni
Leather group 2	Primo, Trace
Leather group 3	Max
Leather group 4	Nubuck, Organic, Vegeta, Cera

Model 3414



Plan Chair Fully upholstered

Designed by Edward Barber & Jay Osgerby, 2022

Fully upholstered chair with frame in tubular steel, powder coated or brushed steel. Inner backrest frame in steel with moulded foam and inner seat in plywood with CMHR or HR foam covered in fabric or leather. Mounted with plastic glides. Felt glides available.

Modeldetails

0,28 m³ Packaging dimensions:
8 kg / L: 46 cm W: 60 cm H: 100 cm
6,5 kg

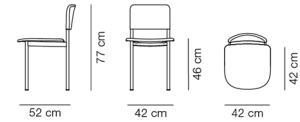

Essential Assortment

Item number	Upholstery	Frame	Price
3414400193000561	Re-Wool 198	Black	505
3414537041420561	Steelcut Quartet 924	Modernist green	505
3414538041400561	Steelcut Quartet 554	Bordeaux	505
3414500193110561	Re-Wool 128	Brushed steel	565
3414400513010561	Leather Omni 301, Black	Black	625
3414400500950561	Leather Max 95, Cognac	Black	690
3414500513010561	Leather Omni 301, Black	Brushed steel	690
3414500500950561	Leather Max 95, Cognac	Brushed steel	760

Essential variants are delivered with plastic glides and HR foam

Order configuration

Frame: Brushed Steel or standard colours: Black, Modernist green, Bordeaux

	Standard colours	Brushed Steel
Fabric group 0	575	645
Fabric group 1	585	655
Fabric group 2	610	685
Fabric group 3	640	715
Fabric group 4	695	770
Fabric group 5	760	830
C.O.M. fabric	585	655
Leather group 0	635	715
Leather group 1	665	735
Leather group 2	690	770
Leather group 3	700	780
Leather group 4	735	815
Leather group 5	805	885
C.O.M. leather	665	735

Fabric consumption: 1 m. Leather consumption: 1 m²

Spare parts: Glides with or without felt (R3412G)

Certifications

EU Ecolabel variants: HR foam and upholstery in Omni leather 301 black, Connect, Remix or Re-wool fabric

FSC® certified

ANSI/BIFMA X5.4-2020, EN 1022:2005, EN 16139:2013 (L2)

Recommended upholstery

Fabric group 0	Connect
Fabric group 1	Linara, Bardal, Capture, Remix, Natural Linen, Re-wool, Grand Linen, Erik
Fabric group 2	Hallingdal, Savoy, Barnum, Steelcut Trio, Fiord, Ruskin, Loop
Fabric group 3	Harald, Vidar, Clay, Sunniva, Divina Melange, Foss
Fabric group 4	Elle, Safire, Sisu
Fabric group 5	Gentle, Grand Mohair
Leather group 0	Vice
Leather group 1	Omni
Leather group 2	Primo, Trace
Leather group 3	Max
Leather group 4	Nubuck, Organic, Vegeta, Cera

Model 3432



Plan Barstool Wooden seat

Designed by Edward Barber & Jay Osgerby, 2023

Barstool with steel frame and plywood veneer seat and back finished with water-based lacquer.
Frame is powder coated tubular steel mounted with plastic glides. Felt glides available. Please specify bar or counter height.

Modeldetails

0,273 m³ Packaging dimensions:
11,6 kg / 8,8 kg L: 54 cm W: 46 cm H: 110 cm

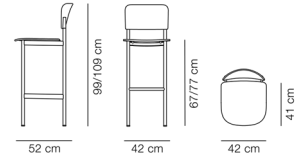

Essential Assortment

Item number	Wood	Frame	Height	Price
34324002027856	Oak lacquer FSC Mix 70%	Black	Sh 78 cm	590
34324002237856	Black ash, FSC Mix 70%	Black	Sh 78 cm	590

Essential variants are delivered with plastic glides bar height

Order configuration

Bar or counter height.

	Oak lacquered	Black ash
Black	590	590
Modernist green	610	610
Bordeaux	610	610

Spare parts: Glides with or without felt (R3412G)

Certifications

EU Ecolabel
FSC® certified
ANSI/BIFMA X5.4-2020

Model 3433



Plan Barstool Seat upholstered

Designed by Edward Barber & Jay Osgerby, 2023

Barstool with steel frame, fully upholstered seat, plywood veneer back finished with water-based lacquer. Inner seat in plywood with CMHR or HR foam covered in fabric or leather.
Frame is powder coated tubular steel mounted with plastic glides. Felt glides available. Please specify bar or counter height.

Modeldetails

0,273 m³ Packaging dimensions:
11,6 kg / 8,8 kg L: 54 cm W: 46 cm H: 110 cm

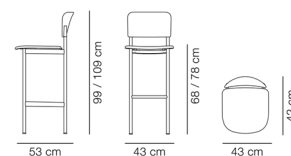

Essential Assortment

Item number	Upholstery	Wood	Frame	Price
34334002021931107856	Re-Wool 128	Oak lacquer FSC Mix 70%	Black	650
34334002231930007856	Re-Wool 198	Black ash, FSC Mix 70%	Black	650
34334002235130107856	Leather Omni 301, Black	Black ash, FSC Mix 70%	Black	705

Essential variants are delivered with plastic glides, HR foam and bar height

Order configuration

Frame: Black, Modernist green or Bordeaux.

Bar or counter height.

	Oak lacquered	Black ash
Fabric group 0	685	685
Fabric group 1	765	765
Fabric group 2	795	795
Fabric group 3	830	830
Fabric group 4	890	890
Fabric group 5	1.000	1.000
C.O.M. fabric	765	765
Leather group 0	775	775
Leather group 1	810	810
Leather group 2	845	845
Leather group 3	860	860
Leather group 4	940	940
Leather group 5	1.070	1.070
C.O.M. leather	810	810

Fabric consumption: 0,6 m. Leather consumption: 0,7 m²

Spare parts: Glides with or without felt (R3412G)

Certifications

EU Ecolabel variants: Modernist Green, Bordeaux or black powder-coated frame together with HR foam and upholstery in Omni leather, Connect, Remix, Re-wool or Steelcut Quartet fabric

FSC® certified

ANSI/BIFMA X5.4-2020

Recommended upholstery

Fabric group 0	Connect
Fabric group 1	Grand Linen, Linara, Bardal, Capture, Remix, Natural Linen, Re-wool, Erik
Fabric group 2	Hallingdal, Savoy, Barnum, Steelcut Trio, Fiord, Ruskin, Loop
Fabric group 3	Harald, Vidar, Clay, Sunniva, Divina Melange, Foss
Fabric group 4	Sisu, Elle, Safire, Cotil
Fabric group 5	Gentle, Grand Mohair
Leather group 0	Vice
Leather group 1	Omni
Leather group 2	Primo, Trace
Leather group 3	Max
Leather group 4	Nubuck, Vegeta, Organic, Cera

Model 3434



Plan Barstool Fully upholstered

Designed by Edward Barber & Jay Osgerby, 2023

Fully upholstered barstool with frame in tubular steel, powder coated or brushed steel. Inner backrest frame in steel with moulded foam and inner seat in plywood with CMHR or HR foam covered in fabric or leather. Mounted with plastic glides. Felt glides available. Please specify bar or counter height.

Modeldetails

0,273 m³ Packaging dimensions:
12 kg / L: 54 cm W: 46 cm H: 110 cm
9,1 kg

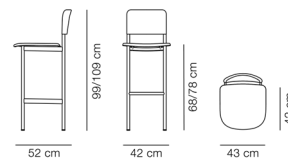

Essential Assortment

Item number	Upholstery	Frame	Height	Price
343440019300078561	Re-Wool 198	Black	Sh 78 cm	705
343453704142078561	Steelcut Quartet 924	Modernist green	Sh 78 cm	705
343453804140078561	Steelcut Quartet 554	Bordeaux	Sh 78 cm	705
343440051301078561	Leather Omni 301, Black	Black	Sh 78 cm	885
343440050095078561	Leather Max 95, Cognac	Black	Sh 78 cm	945
343450019311078561	Re-Wool 128	Brushed steel	Sh 78 cm	945
343450051301078561	Leather Omni 301, Black	Brushed steel	Sh 78 cm	1.060
343450050095078561	Leather Max 95, Cognac	Brushed steel	Sh 78 cm	1.120

Essential variants are delivered with plastic glides, HR foam and bar height

Order configuration

Frame: Brushed Steel or standard colours: Black, Modernist green, Bordeaux
Bar or counter height.

	Standard colours	Brushed Steel
Fabric group 0	770	985
Fabric group 1	905	1.115
Fabric group 2	960	1.170
Fabric group 3	1.015	1.225
Fabric group 4	1.120	1.325
Fabric group 5	1.300	1.505
C.O.M. fabric	905	1.115
Leather group 0	905	1.115
Leather group 1	955	1.165
Leather group 2	1.005	1.215
Leather group 3	1.040	1.235
Leather group 4	1.150	1.340
Leather group 5	1.340	1.530
C.O.M. leather	955	1.165

Fabric consumption: 1 m. Leather consumption: 1 m²

Spare parts: Glides with or without felt (R3412G)

Certifications

EU Ecolabel variants: Brushed Steel, Modernist Green, Bordeaux or black powder-coated frame together with HR foam and upholstery in Omni leather, Connect, Remix, Re-wool or Steelcut Quartet fabric

FSC® certified

ANSI/BIFMA X5.4-2020, EN 1022:2005, EN 16139:2013 (L2)

Recommended upholstery

Fabric group 0	Connect
Fabric group 1	Grand Linen, Linara, Bardal, Capture, Remix, Natural Linen, Re-wool, Erik
Fabric group 2	Hallingdal, Savoy, Barnum, Steelcut Trio, Fiord, Ruskin, Loop
Fabric group 3	Harald, Vidar, Clay, Sunniva, Divina Melange, Foss
Fabric group 4	Sisu, Elle, Safire, Cotil
Fabric group 5	Gentle, Grand Mohair
Leather group 0	Vice
Leather group 1	Omni
Leather group 2	Primo, Trace
Leather group 3	Max
Leather group 4	Nubuck, Vegeta, Organic, Cera

Model 3445

Post Armchair Wooden seat



Designed by Cecilie Manz, 2019

Frame of solid wood. Back and seat of moulded veneer. Veneer core in the same wood as top veneer.

Modeldetails

0,25 m³ Packaging dimensions:
7,9 kg / 5 kg L: 53 cm W: 57 cm H: 82,5 cm

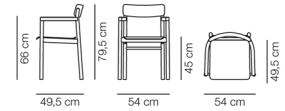

Essential Assortment

Item number	Wood	Price
344500500	Black lacquered	790
344510700	Oak light oil	790

Order configuration

	Oak lacquered	Oak light oil	Oak black lacquered
	860	790	790

Extra charge for

QuickClick glides with or without felt: +24

Certifications

EN 1022:2005, EN 16139:2013 (L1)

Model 3446

Post Armchair Seat upholstered



Designed by Cecilie Manz, 2019

Frame of solid wood. Back and seat of moulded veneer. Veneer core in the same wood as top veneer. Non-removable seat pad upholstered with CMHR or HR foam and covered in fabric or leather.

Modeldetails

0,25 m³ Packaging dimensions:
8,8 kg / 6 kg L: 53 cm W: 57 cm H: 82,5 cm

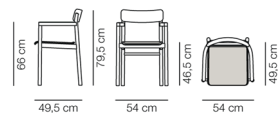

Essential Assortment

Item number	Upholstery	Wood	Price
344650095010700	Leather Max 95, Cognac	Oak light oil	910
344651301000500	Leather Omni 301, Black	Black lacquered	910

Essential variants only delivered with HR foam

Order configuration

	Oak lacquered	Oak light oil	Oak black lacquered
Fabric group 0	880	880	880
Fabric group 1	950	950	950
Fabric group 2	990	990	990
Fabric group 3	1.025	1.025	1.025
Fabric group 4	1.095	1.095	1.095
Fabric group 5	1.185	1.185	1.185
C.O.M. fabric	950	950	950
Leather group 0	885	885	885
Leather group 1	955	955	955
Leather group 2	995	995	995
Leather group 3	1.030	1.030	1.030
Leather group 4	1.070	1.070	1.070
Leather group 5	1.230	1.230	1.230
C.O.M. leather	955	955	955

Fabric consumption: 0,26 m. Leather consumption: 0,45 m²

Extra charge for

QuickClick glides with or without felt: +24

Certifications

EN 1022:2005, EN 16139:2013 (L1)

Recommended upholstery

Fabric group 0	Connect
Fabric group 1	Grand Linen, Remix, Capture, Bardal, Re-wool, Linara, Natural Linen, Erik
Fabric group 2	Hallingdal, Barnum, Loop, Steelcut Trio, Fiord, Ruskin, Savoy
Fabric group 3	Divina Melange, Vidar, Sunniva, Harald, Foss, Clay
Fabric group 4	Cotil, Elle, Sisu, Safire
Fabric group 5	Grand Mohair, Gentle
Leather group 0	Vice
Leather group 1	Omni
Leather group 2	Primo, Trace
Leather group 3	Max
Leather group 4	Nubuck, Organic, Vegeta, Cera

Model 3237

The Spanish Dining Chair



Designed by Børge Mogensen, 1964

Chair with frame of solid wood. Seat and back in vegetable tanned saddle leather with metal buckles. Leather seat has canvas backing. Saddle straps can be tightened as the leather expands through use.

Modeldetails

0,32 m³ Packaging dimensions:
9,5 kg / 7,7 kg L: 54 cm W: 60,5 cm H: 99 cm

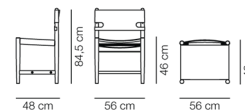

Essential Assortment

Item number	Upholstery	Wood	Price
323710750502	Leather, cognac	Oak light oil	2.050
323710350500	Leather, natural	Oak soap	2.290
323710950501	Leather, black	Smoked oak, oiled	2.410

Order configuration

	Oak soap	Oak oiled	Oak light oil	Oak black lacquered	Smoked oak, oiled
Natural leather	2.290	2.415	2.415	2.415	2.780
Black leather	2.235	2.235	2.235	2.235	2.410
Cognac leather	2.235	2.235	2.050	2.235	2.570
Dark Brown leather	2.235	2.235	2.235	2.235	2.570

Extra charge for

QuickClick glides with or without felt (R3237): +24

Certifications

EN 1022:2005, EN 16139:2013 (L2)

Model 3238

The Spanish Dining Chair Armchair



Designed by Børge Mogensen, 1964

Armchair with frame of solid wood. Seat and back in vegetable tanned saddle leather with metal buckles. Leather seat has canvas backing. Saddle straps can be tightened as the leather expands through use.

Model details

0,3 m³ Packaging dimensions:
10 kg / 8,9 kg L: 53 cm W: 69 cm H: 83 cm

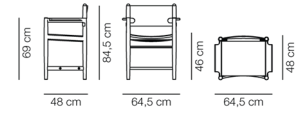

Essential Assortment

Item number	Upholstery	Wood	Price
323810750502	Leather, cognac	Oak light oil	2.290
323810350500	Leather, natural	Oak soap	2.530
323810950501	Leather, black	Smoked oak, oiled	2.650

Order configuration

	Oak soap	Oak oiled	Oak light oil	Oak black lacquered	Smoked oak, oiled
Natural leather	2.530	2.635	2.635	2.635	3.185
Black leather	2.440	2.440	2.440	2.440	2.650
Cognac leather	2.440	2.440	2.290	2.440	2.805
Dark Brown leather	2.440	2.440	2.440	2.440	2.805

Extra charge for

QuickClick glides with or without felt (R3237): +24

Certifications

EN 1022:2005, EN 16139:2013 (L2)

Model P3237

The Spanish Dining Chair Accs. Leather set for 3237 / 3238



Designed by Børge Mogensen

Seat and back in vegetable tanned saddle leather with metal buckles. Leather seat has canvas backing. Saddle straps can be tightened as the leather expands through use.

Order configuration

	Natural leather	Black leather	Cognac leather	Dark Brown leather
	1.605	1.445	1.445	1.445

Model 3050

Søborg Wood base Chair Wooden seat



Designed by Børge Mogensen, 1950

Frame of solid wood, seat and back of moulded plywood. Interchangeable seat and back mounted with black metal screws. Mounted with plastic glides.

Modeldetails

0,4 m³ Packaging dimensions:
7,6 kg / 5 kg L: 58 cm W: 62 cm H: 97 cm

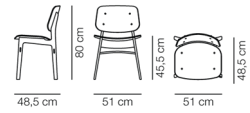

Essential Assortment

Item number	Wood	Price
3050202868	Oak lacquer FSC Mix 70%	565
3050224856	Oak black lacquer, FSC Mix 70%	565
3050162730	Walnut lacquer	685

Essential variants are delivered with plastic glides

Order configuration

	Oak lacquered	Oak oiled	Oak black lacquered	Walnut lacquered
	565	630	565	685

Extra charge for

Glides with felt: +12

Certifications

Oak is FSC® certified
EN 1022:2005, EN 16139:2013 (L2)

Model 3051

Søborg Wood base Chair Seat upholstered



Designed by Børge Mogensen, 1950

Wooden side chair with upholstered seat. Frame of solid wood, seat and back of moulded plywood. Interchangeable seat pad upholstered in CMHR or HR foam with fixed cover in fabric or leather. Interchangeable back mounted with black metal screws. Mounted with plastic glides.

Modeldetails

0,34 m³ Packaging dimensions:
8,2 kg / 5,6 kg L: 58 cm W: 62 cm H: 97 cm

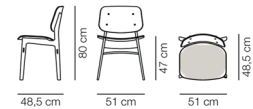

Essential Assortment

Item number	Upholstery	Wood	Price
305120286800219	Hallingdal 130	Oak lacquer FSC Mix 70%	675
305120286851301	Leather Omni 301, Black	Oak lacquer FSC Mix 70%	675
305122485600219	Hallingdal 130	Oak black lacquer, FSC Mix 70%	675
305122485651301	Leather Omni 301, Black	Oak black lacquer, FSC Mix 70%	675
305116273000219	Hallingdal 130	Walnut lacquer	855
305116273051301	Leather Omni 301, Black	Walnut lacquer	855
305120286850095	Leather Max 95, Cognac	Oak lacquer FSC Mix 70%	855

Essential variants are delivered with plastic glides and HR foam

Order configuration

	Oak lacquered	Oak oiled	Oak black lacquered	Walnut lacquered
Fabric group 1	725	725	725	870
Fabric group 2	745	745	745	895
Fabric group 3	775	775	775	930
Fabric group 4	810	810	810	975
Fabric group 5	850	850	850	1.020
C.O.M. fabric	725	725	725	870
Leather group 0	710	710	710	855
Leather group 1	765	765	765	920
Leather group 2	820	820	820	985
Leather group 3	890	890	890	1.065
Leather group 4	980	980	980	1.175
Leather group 5	1.125	1.125	1.125	1.350
C.O.M. leather	765	765	765	920

Fabric consumption: 0,6 m. Leather consumption: 0,54 m²

Extra charge for

Glides with felt: +12

Certifications

Oak is FSC® certified
EN 1022:2005, EN 16139:2013 (L2)

Recommended upholstery

Fabric group 1	Grand Linen, Linara, Bardal, Capture, Remix, Natural Linen, Re-wool, Erik
Fabric group 2	Hallingdal, Savoy, Barnum, Steelcut Trio, Fiord, Ruskin, Loop
Fabric group 3	Harald, Vidar, Clay, Sunniva, Divina Melange, Foss
Fabric group 4	Sisu, Elle, Safire, Cotil
Fabric group 5	Gentle, Grand Mohair
Leather group 0	Vice
Leather group 1	Omni
Leather group 2	Primo, Trace
Leather group 3	Max
Leather group 4	Vegeta, Nubuck, Organic, Cera

Model 3052

Søborg Wood base Chair Front upholstered



Designed by Børge Mogensen, 1950

Wooden side chair with upholstered seat and back. Frame of solid wood, seat and back of moulded plywood. Interchangeable seat pad and non-removeable back upholstered in CMHR or HR foam with fixed cover in fabric or leather. Mounted with plastic glides.

Modeldetails

0,34 m³ Packaging dimensions:
9,2 kg / 6,6 kg L: 58 cm W: 62 cm H: 97 cm

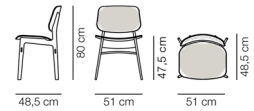

Order configuration

	Oak lacquered	Oak oiled	Oak black lacquered	Walnut lacquered
Fabric group 1	825	825	825	990
Fabric group 2	875	875	875	1.050
Fabric group 3	930	930	930	1.120
Fabric group 4	1.015	1.015	1.015	1.220
Fabric group 5	1.120	1.120	1.120	1.340
C.O.M. fabric	825	825	825	990
Leather group 0	830	830	830	995
Leather group 1	890	890	890	1.070
Leather group 2	995	995	995	1.190
Leather group 3	1.110	1.110	1.110	1.330
Leather group 4	1.220	1.220	1.220	1.465
Leather group 5	1.405	1.405	1.405	1.685
C.O.M. leather	890	890	890	1.070

Fabric consumption: 0,6 m. Leather consumption: 0,9 m²

Extra charge for

Glides with felt: +12

Certifications

Oak is FSC® certified
EN 1022:2005, EN 16139:2013 (L2)

Recommended upholstery

Fabric group 1	Grand Linen, Linara, Bardal, Capture, Remix, Natural Linen, Re-wool, Erik
Fabric group 2	Hallingdal, Savoy, Barnum, Steelcut Trio, Fiord, Ruskin, Loop
Fabric group 3	Harald, Vidar, Clay, Sunniva, Divina Melange, Foss
Fabric group 4	Sisu, Elle, Safire, Cotil
Fabric group 5	Gentle, Grand Mohair
Leather group 0	Vice
Leather group 1	Omni
Leather group 2	Primo, Trace
Leather group 3	Max
Leather group 4	Vegeta, Nubuck, Organic, Cera

Model 3060

Søborg Metal base Chair Wooden seat



Designed by Børge Mogensen, 1952

Plywood side chair with steel frame. Interchangeable seat and back mounted with black metal screws. Mounted with plastic glides.

Modeldetails

0,34 m³ Packaging dimensions:
8,6 kg / 6 kg L: 58 cm W: 62 cm H: 97 cm

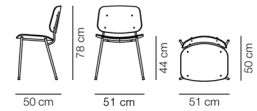

Essential Assortment

Item number	Wood	Frame	Price
3060202400	Oak lacquer FSC Mix 70%	Black	565
3060224400	Oak black lacquer, FSC Mix 70%	Black	565
3060162400	Walnut lacquer	Black	685

Essential variants are delivered with plastic glides

Order configuration

	Oak lacquered	Oak oiled	Oak black lacquered	Walnut lacquered
Black	565	605	565	685
Chrome	605	605	605	730

Other frame colours by quotation (min. 20 pcs.).

Extra charge for

Glides with felt: +12

Certifications

Oak is FSC® certified
EN 1022:2005, EN 16139:2013 (L2)

Model 3061

Søborg Metal base Chair Seat upholstered



Designed by Børge Mogensen, 1952

Plywood side chair with steel frame. Interchangeable seat pad upholstered in CMHR or HR foam with fixed cover in fabric or leather. Interchangeable back mounted with black metal screws. Mounted with plastic glides.

Modeldetails

0,34 m³ Packaging dimensions:
9,5 kg / 6,9 kg L: 58 cm W: 62 cm H: 97 cm

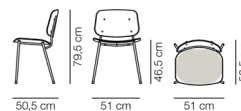

Essential Assortment

Item number	Upholstery	Wood	Frame	Price
306120210000219	Hallingdal 130	Oak lacquer FSC Mix 70%	Chrome	675
306120240051301	Leather Omni 301, Black	Oak lacquer FSC Mix 70%	Black	675
306122410000219	Hallingdal 130	Oak black lacquer, FSC Mix 70%	Chrome	675
306122440051301	Leather Omni 301, Black	Oak black lacquer, FSC Mix 70%	Black	675
306116210000219	Hallingdal 130	Walnut lacquer	Chrome	855
306116240051301	Leather Omni 301, Black	Walnut lacquer	Black	855

Essential variants are delivered with plastic glides and HR foam

Order configuration

Frame: Chrome or black.

	Oak lacquered	Oak oiled	Oak black lacquered	Walnut lacquered
Fabric group 1	727	727	727	872
Fabric group 2	752	752	752	902
Fabric group 3	782	782	782	932
Fabric group 4	817	817	817	977
Fabric group 5	857	857	857	1.022
C.O.M. fabric	727	727	727	872
Leather group 0	717	717	717	857
Leather group 1	772	772	772	922
Leather group 2	822	822	822	987
Leather group 3	892	892	892	1.067
Leather group 4	982	982	982	1.172
Leather group 5	1.127	1.127	1.127	1.347
C.O.M. leather	772	772	772	922

Fabric consumption: 0,6 m. Leather consumption: 0,54 m²

Other frame colours by quotation (min. 20 pcs.).

Extra charge for

Glides with felt: +12

Certifications

Oak is FSC® certified

EN 1022:2005, EN 16139:2013 (L2)

Recommended upholstery

Fabric group 1	Grand Linen, Linara, Bardal, Capture, Remix, Natural Linen, Re-wool, Erik
Fabric group 2	Hallingdal, Savoy, Barnum, Steelcut Trio, Fiord, Ruskin, Loop
Fabric group 3	Harald, Vidar, Clay, Sunniva, Divina Melange, Foss
Fabric group 4	Sisu, Elle, Safire, Cotil
Fabric group 5	Gentle, Grand Mohair
Leather group 0	Vice
Leather group 1	Omni
Leather group 2	Primo, Trace
Leather group 3	Max
Leather group 4	Nubuck, Organic, Vegeta, Cera

Model 3062

Søborg Metal base Chair Front upholstered



Designed by Børge Mogensen, 1952

Plywood side chair with steel frame. Interchangeable seat pad and non-removeable back upholstered in CMHR or HR foam with fixed cover in fabric or leather. Mounted with plastic glides.

Modeldetails

0,34 m³ Packaging dimensions:
10,2 kg / 7,6 kg L: 58 cm W: 62 cm H: 97 cm



Essential Assortment

Item number	Upholstery	Wood	Frame	Price
306220210000219056	Hallingdal 130	Oak lacquer FSC Mix 70%	Chrome	735
306220240051301056	Leather Omni 301, Black	Oak lacquer FSC Mix 70%	Black	735
306222410000219056	Hallingdal 130	Oak black lacquer, FSC Mix 70%	Chrome	735
306222440051301056	Leather Omni 301, Black	Oak black lacquer, FSC Mix 70%	Black	735

Essential variants are delivered with plastic glides and HR foam

Order configuration

Frame: Chrome or black.

	Oak lacquered	Oak oiled	Oak black lacquered	Walnut lacquered
Fabric group 1	815	815	815	975
Fabric group 2	865	865	865	1.040
Fabric group 3	920	920	920	1.105
Fabric group 4	1.005	1.005	1.005	1.205
Fabric group 5	1.105	1.105	1.105	1.325
C.O.M. fabric	815	815	815	975
Leather group 0	820	820	820	980
Leather group 1	880	880	880	1.055
Leather group 2	980	980	980	1.175
Leather group 3	1.095	1.095	1.095	1.315
Leather group 4	1.205	1.205	1.205	1.445
Leather group 5	1.385	1.385	1.385	1.660
C.O.M. leather	880	880	880	1.055

Fabric consumption: 0,6 m. Leather consumption: 0,9 m²

Other frame colours by quotation (min. 20 pcs.).

Extra charge for

Glides with felt: +12

Certifications

Oak is FSC® certified

EN 1022:2005, EN 16139:2013 (L2)

Recommended upholstery

Fabric group 1	Grand Linen, Linara, Bardal, Capture, Remix, Natural Linen, Re-wool, Erik
Fabric group 2	Hallingdal, Savoy, Barnum, Steelcut Trio, Fiord, Ruskin, Loop
Fabric group 3	Harald, Vidar, Clay, Sunniva, Divina Melange, Foss
Fabric group 4	Sisu, Elle, Safire, Cotil
Fabric group 5	Gentle, Grand Mohair
Leather group 0	Vice
Leather group 1	Omni
Leather group 2	Primo, Trace
Leather group 3	Max
Leather group 4	Nubuck, Organic, Vegeta, Cera

**Model
3090**

Søborg Accessories
Chair suspensions

Chair suspensions in black powder coated steel.

Order configuration

	No template	Template enclosed
Black	70	165

Model 1721

Spine Wood Chair Front upholstered



Designed by Space Copenhagen, 2011

Chair with legs of solid wood with powder coated aluminum stretcher. Seat shell of plywood with beech core. Front side of seat shell upholstered with CMHR or HR foam and covered in fabric or leather, finished with piping.

Modeldetails

0,3 m³ Packaging dimensions:
10 kg / 8 kg L: 61 cm W: 54 cm H: 83 cm

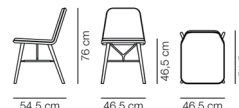

Essential Assortment

Item number	Upholstery	Wood	Price
1721756500110000	Leather Vice 11, Black	Ash, black lacquer - black metal, FSC MIX 70%	1.125
1721756586800000	Leather Trace 8680, Heritage brown	Ash, black lacquer - black metal, FSC MIX 70%	1.250
1721757002070000	Hallingdal 200	Oak lacquer - black metal, FSC Mix 70%	1.500
1721755511120000	Leather Omni 112, Warm grey	Smoked oak stained lacq. -black metal, FSC Mix 70%	1.625

Essential variants only delivered with HR foam

Order configuration

	Oak lacquered	Black ash	Smoked oak stained, lacquered
Fabric group 0	1.530	1.205	1.680
Fabric group 1	1.645	1.295	1.810
Fabric group 2	1.675	1.330	1.845
Fabric group 3	1.725	1.380	1.900
Fabric group 4	1.810	1.465	1.990
Fabric group 5	1.925	1.555	2.115
C.O.M. fabric	1.645	1.295	1.810
Leather group 0	1.565	1.240	1.720
Leather group 1	1.680	1.335	1.850
Leather group 2	1.750	1.400	1.925
Leather group 3	1.815	1.465	1.995
Leather group 4	1.995	1.615	2.195
Leather group 5	2.295	1.855	2.525
C.O.M. leather	1.680	1.335	1.850

Fabric consumption: 0,6 m. Leather consumption: 0,9 m²

Metal parts: Black.

Extra Charge for

QuickClick glides with or without felt: +12

Certifications

FSC® certified
EN 1022:2005, EN 16139:2013 (L1)

Recommended upholstery

Fabric group 0	Connect
Fabric group 1	Grand Linen, Linara, Bardal, Capture, Remix, Re-wool, Natural Linen, Erik
Fabric group 2	Hallingdal, Savoy, Barnum, Steelcut Trio, Fiord, Ruskin, Loop
Fabric group 3	Harald, Vidar, Clay, Sunniva, Divina Melange, Foss
Fabric group 4	Sisu, Safire, Cotil, Elle
Fabric group 5	Gentle, Grand Mohair
Leather group 0	Vice
Leather group 1	Omni
Leather group 2	Primo, Trace
Leather group 3	Max
Leather group 4	Nubuck, Organic, Vegeta, Cera

Model 1731



Spine Wood Barstool Front upholstered

Designed by Space Copenhagen, 2011

Barstool with legs of solid wood with powder coated aluminum stretcher. Seat shell of plywood with beech core. Front side of seat shell is upholstered with CMHR or HR foam and covered in fabric or leather, finished with piping. Please specify counter- or bar height.

Modeldetails

0,34 m³ Packaging dimensions:
13,3 kg / 10,2 kg L: 57 cm W: 53 cm H: 109/120 cm

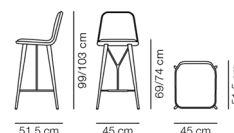

Essential Assortment

Item number	Upholstery	Wood	Seat height	Price
1731756500110400	Leather Vice 11, Black	Ash, black lacquer - black metal, FSC MIX 70%	74 cm	1.180
1731756586800400	Leather Trace 8680, Heritage brown	Ash, black lacquer - black metal, FSC MIX 70%	74 cm	1.300
1731757002070400	Hallingdal 200	Oak lacquer - black metal, FSC Mix 70%	74 cm	1.535
1731755511120400	Leather Omni 112, Warm grey	Smoked oak stained lacq. -black metal, FSC Mix 70%	74 cm	1.770

Essential variants only delivered with HR foam

Order configuration

Bar or counter height.

	Oak lacquered	Black ash	Smoked oak stained, lacquered
Fabric group 0	1.560	1.230	1.715
Fabric group 1	1.675	1.320	1.845
Fabric group 2	1.710	1.355	1.880
Fabric group 3	1.760	1.405	1.935
Fabric group 4	1.845	1.495	2.030
Fabric group 5	1.960	1.585	2.155
C.O.M. fabric	1.675	1.320	1.845
Leather group 0	1.595	1.265	1.755
Leather group 1	1.715	1.360	1.885
Leather group 2	1.785	1.430	1.965
Leather group 3	1.850	1.495	2.035
Leather group 4	2.035	1.645	2.240
Leather group 5	2.340	1.895	2.575
C.O.M. leather	1.715	1.360	1.885

Fabric consumption: 0,6 m. Leather consumption: 0,96 m²

Metal parts: Black.

Extra Charge for

QuickClick glides with or without felt:

+12

Certifications

FSC® certified

EN 1022:2005, EN 16139:2013 (L1)

Recommended upholstery

Fabric group 0	Connect
Fabric group 1	Grand Linen, Linara, Bardal, Capture, Remix, Re-wool, Natural Linen, Erik
Fabric group 2	Hallingdal, Savoy, Barnum, Steelcut Trio, Fiord, Ruskin, Loop
Fabric group 3	Harald, Vidar, Clay, Sunniva, Divina Melange, Foss
Fabric group 4	Sisu, Safire, Cotil, Elle
Fabric group 5	Gentle, Grand Mohair
Leather group 0	Vice
Leather group 1	Omni
Leather group 2	Primo, Trace
Leather group 3	Max
Leather group 4	Nubuck, Organic, Vegeta, Cera

Model 1736

Spine Wood Stool Seat upholstered



Designed by Space Copenhagen, 2014

Legs of solid wood with powder coated aluminum stretcher. Seat shell of plywood with beech core and oak top veneer. Seat is upholstered with CMHR or HR foam and covered in fabric or leather. Please specify counter or bar height.

Modeldetails

0,14 m³ Packaging dimensions:
6,5 kg / 5,74 kg L: 39 cm W: 46 cm H: 72/78 cm

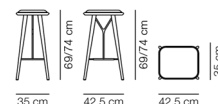

Essential Assortment

Item number	Upholstery	Wood	Seat height	Price
1736756500110400	Leather Vice 11, Black	Ash, black lacquer - black metal, FSC MIX 70%	74 cm	705
1736756586800400	Leather Trace 8680, Heritage brown	Ash, black lacquer - black metal, FSC MIX 70%	74 cm	825
1736757002070400	Hallingdal 200	Oak lacquer - black metal, FSC Mix 70%	74 cm	945
1736755511120400	Leather Omni 112, Warm grey	Smoked oak stained lacq. -black metal, FSC Mix 70%	74 cm	1.060

Essential variants only delivered with HR foam

Order configuration

Bar or counter height.

	Oak lacquered	Black ash	Smoked oak stained, lacquered
Fabric group 0	975	770	1.075
Fabric group 1	1.050	825	1.155
Fabric group 2	1.065	840	1.170
Fabric group 3	1.080	855	1.190
Fabric group 4	1.105	875	1.215
Fabric group 5	1.135	910	1.245
C.O.M. fabric	1.050	825	1.155
Leather group 0	990	780	1.090
Leather group 1	1.065	840	1.170
Leather group 2	1.080	855	1.190
Leather group 3	1.105	880	1.220
Leather group 4	1.220	970	1.340
Leather group 5	1.400	1.115	1.540
C.O.M. leather	1.065	840	1.170

Fabric consumption: 0,57 m. Leather consumption: 0,44 m²

Metal parts: Black.

Extra Charge for

QuickClick glides with or without felt: +12

Certifications

FSC® certified

EN 1022:2005, EN 16139:2013 (L1)

Recommended upholstery

Fabric group 0	Connect
Fabric group 1	Grand Linen, Linara, Bardal, Capture, Remix, Re-wool, Natural Linen, Erik
Fabric group 2	Hallingdal, Savoy, Barnum, Steelcut Trio, Fiord, Ruskin, Loop
Fabric group 3	Harald, Vidar, Clay, Sunniva, Divina Melange, Foss
Fabric group 4	Sisu, Safire, Cotil, Elle
Fabric group 5	Gentle, Grand Mohair
Leather group 0	Vice
Leather group 1	Omni
Leather group 2	Primo, Trace
Leather group 3	Max
Leather group 4	Nubuck, Organic, Vegeta, Cera

Model 1777

Swoon Dining Armchair Wood base



Designed by Space Copenhagen, 2019

Fully upholstered chair with solid wood legs mounted with metal thread. Inner shell in moulded high pressure polyurethane foam, reinforced with a steel frame. Removable seat cushion with CMHR or HR foam with removable cover. Available in fabric or leather. Mounted with plastic glides. Felt glides available.

Modeldetails

0,43 m³ Packaging dimensions:
15 kg / L: 69,2 cm W: 69,7 cm H: 90 cm
10,9 kg

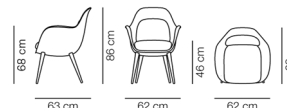

Essential Assortment

Item number	Upholstery	Legs	Price
17770772200005202005	Sunniva 242	Oak lacquer, FSC Mix 70%	1.515
17770773900005162005	Sunniva 717	Walnut lacquer	1.515
17770774500005224005	Sunniva 192	Oak black lacquer FSC Mix 70%	1.515

Essential variants are delivered with plastic glides and HR foam

Order configuration

Legs: Walnut lacquered, oak lacquered, oak oiled, smoked oak stained lacquered or oak black lacquered.

Fabric group 0	1.355
Fabric group 1	1.460
Fabric group 2	1.615
Fabric group 3	1.755
Fabric group 4	2.025
Fabric group 5	2.380
C.O.M. fabric	1.460
Leather group 1	1.685
Leather group 2	1.940
Leather group 3	2.160
Leather group 4	2.390
Leather group 5	2.750
C.O.M. leather	1.685

Fabric consumption: 3 m. Leather consumption: 5 m²

Different fabrics on corpus and cushion upon request.

Certifications

Oak is FSC® certified

EN 1022:2005, EN 16139:2013 (L2), ANSI/BIFMA M7.1 Standard Test Method for Determining VOC Emissions from Office (tested with ECO-label fabric and HR-foam)

Recommended upholstery

Fabric group 0	Connect
Fabric group 1	Capture, Re-wool, Bardal, Linara, Remix, Erik
Fabric group 2	Hallingdal, Savoy, Barnum, Steelcut Trio, Ruskin, Fiord, Loop
Fabric group 3	Foss, Sunniva, Harald, Divina Melange, Vidar, Clay
Fabric group 4	Safire, Sisu, Elle
Fabric group 5	Gentle, Grand Mohair
Leather group 1	Omni
Leather group 2	Primo, Trace
Leather group 3	Max
Leather group 4	Vegeta, Nubuck, Organic

Model 1779

Swoon Dining Armchair Swivel base



Designed by Space Copenhagen, 2019

Fully upholstered dining chair with aluminum swivel base. Inner shell in moulded polyurethane foam, reinforced with a steel frame. Removable seat cushion with CMHR or HR foam with removable cover. Available in fabric or leather. Mounted with plastic glides.

Modeldetails

0,43 m³ Packaging dimensions:
22 kg / 16 kg L: 69,2 cm W: 69,7 cm H: 90 cm

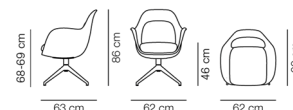

Essential Assortment

Item number	Upholstery	Frame	Price
17790772200005905040	Sunniva 242	Swivel base polished aluminium	1.645
17790773900005451040	Sunniva 717	Swivel base black	1.645
17790774500005451040	Sunniva 192	Swivel base black	1.645

Essential variants are delivered with plastic glides and HR foam

Order configuration

Frame: Polished aluminium or black.

Fabric group 0	1.535
Fabric group 1	1.655
Fabric group 2	1.810
Fabric group 3	1.950
Fabric group 4	2.220
Fabric group 5	2.575
C.O.M. fabric	1.655
Leather group 1	1.880
Leather group 2	2.135
Leather group 3	2.355
Leather group 4	2.585
Leather group 5	2.975
C.O.M. leather	1.880

Fabric consumption: 3 m. Leather consumption: 5 m²

Different fabrics on corpus and cushion upon request.

Extra charge for

Castors, chrome or black: +26

Certifications

EN 1022:2005, EN 16139:2013 (L2), ANSI/BIFMA M7.1 Standard Test Method for Determining VOC Emissions from Office (tested with ECO-label fabric and HR-foam)

Recommended upholstery

Fabric group 0	Connect
Fabric group 1	Capture, Re-wool, Bardal, Linara, Remix, Erik
Fabric group 2	Hallingdal, Savoy, Barnum, Steelcut Trio, Ruskin, Fiord, Loop
Fabric group 3	Foss, Sunniva, Harald, Divina Melange, Vidar, Clay
Fabric group 4	Safire, Sisu, Elle
Fabric group 5	Gentle, Grand Mohair
Leather group 1	Omni
Leather group 2	Primo, Trace
Leather group 3	Max
Leather group 4	Vegeta, Nubuck, Organic

Model 3398

Trinidad Chair Wooden seat



Designed by Nanna Ditzel, 1993

Stacking chair. Frame of steel tube, back of moulded plywood with CNC-milled cut-outs. Seat and back mounted with rivets. Mounted with interchangeable plastic glides.

Modeldetails

0,4 m³ Packaging dimensions:
5,8 kg / 4,9 kg L: 71,5 cm W: 53,5 cm H: 103 cm



Essential Assortment

Item number	Wood	Frame	Price
339821200000450016	Beech, lacquer, FSC Mix 70%	Black	470
339827500000100016	Beech nordic blue, FSC Mix 70%	Chrome	470
339828000000100016	Beech khaki green, FSC Mix 70%	Chrome	470
339820200000100016	Oak lacquer FSC Mix 70%	Chrome	530
339822300000100016	Black ash, FSC Mix 70%	Chrome	530
339822600000450016	Walnut lacquer, FSC Mix 70%	Black	530
339829100000551016	Grey oak stained, lacq. FSC Mix 70%	Flint	530
339814400000100016	Oregon pine aged lacquer	Chrome	530

Essential variants are delivered with plastic glides

Order configuration

	Black ash	Beech lacquered / Beech coloured lacquer	Oak lacquered / Oak oiled / Oregon pine aged lacquer	Walnut lacquered	Light grey / Grey	Smoked oak stained, lacquered
Black	555	470	555	530	555	555
Flint	555	485	555	555	555	555
Chrome	530	485	555	555	555	555

Beech coloured lacquer: Nordic blue, Khaki green

Stackable: 8 pcs.

Extra charge for

Glides with felt: +12
Frame brushed stainless steel - each: +177

Certifications

FSC® certified
EN 1022:2005, EN 16139:2013 (L2)

Model 3396

Trinidad Chair Seat upholstered



Designed by Nanna Ditzel, 1993

Wood chair with steel frame and upholstered seat. Frame of steel tube, back of moulded plywood with CNC-milled cut-outs. Fixed interchangeable seat pad upholstered in CMHR or HR foam, covered in fabric or leather. Seat and back mounted with rivets. Mounted with interchangeable plastic glides.

Modeldetails

0,4 m³ Packaging dimensions:
5,9 kg / 5 kg L: 71,5 cm W: 53,5 cm H: 103 cm



Essential Assortment

Item number	Upholstery	Wood	Frame	Price
339621251301450016	Leather Omni 301, Black	Beech, lacquer, FSC Mix 70%	Black	565
339620251301100016	Leather Omni 301, Black	Oak lacquer FSC Mix 70%	Chrome	625
339622351301100016	Leather Omni 301, Black	Black ash, FSC Mix 70%	Chrome	625
339622651301450016	Leather Omni 301, Black	Walnut lacquer, FSC Mix 70%	Black	625
339629151301551016	Leather Omni 301, Black	Grey oak stained, lacq. FSC Mix 70%	Flint	625

Essential variants are delivered with plastic glides and HR foam

Order configuration

Frame: Chrome, black or flint.

	Black ash	Beech lacquered / Beech coloured lacquer	Oak lacquered / Oak oiled / Oregon pine aged lacquer	Walnut lacquered	Light grey / Grey	Smoked oak stained, lacquered
Fabric group 0	615	555	615	615	615	615
Fabric group 1	660	595	660	660	660	660
Fabric group 2	670	605	670	670	670	670
Fabric group 3	680	615	680	680	680	680
Fabric group 4	690	625	690	690	690	690
Fabric group 5	720	655	720	720	720	720
C.O.M. fabric	660	595	660	660	660	660
Leather group 0	635	575	635	635	635	635
Leather group 1	685	620	685	685	685	685
Leather group 2	730	665	730	730	730	730
Leather group 3	765	700	765	765	765	765
Leather group 4	800	735	800	800	800	800
Leather group 5	920	845	920	920	920	920
C.O.M. leather	685	620	685	685	685	685

Fabric consumption: 0,5 m. Leather consumption: 0,44 m²

Beech coloured lacquer: Nordic blue, Khaki green.

Extra charge for

Glides with felt: +12
Frame brushed stainless steel - each: +177

Certifications

FSC® certified
EN 1022:2005, EN 16139:2013 (L2)

Recommended upholstery

Fabric group 0	Connect
Fabric group 1	Grand Linen, Remix, Capture, Bardal, Re-wool, Linara, Natural Linen, Erik
Fabric group 2	Hallingdal, Barnum, Loop, Steelcut Trio, Fiord, Ruskin, Savoy
Fabric group 3	Divina Melange, Vidar, Sunniva, Harald, Foss, Clay
Fabric group 4	Sisu, Safire, Elle, Cotil
Fabric group 5	Grand Mohair, Gentle
Leather group 0	Vice
Leather group 1	Omni
Leather group 2	Primo, Trace
Leather group 3	Max
Leather group 4	Nubuck, Organic, Vegeta, Cera

Model 3399

Trinidad Armchair Wooden seat



Designed by Nanna Ditzel, 1993

Chair with arms, non stackable. Frame of steel tube, seat and back of moulded plywood with CNC-milled cut-outs. Seat and back mounted with rivets. Mounted with interchangeable plastic glides.

Modeldetails

0,46 m³ Packaging dimensions:
7,8 kg / 5,8 kg L: 64 cm W: 71 cm H: 100 cm



Essential Assortment

Item number	Wood	Frame	Price
339921200000450016	Beech, lacquer, FSC Mix 70%	Black	705
339920200000100016	Oak lacquer FSC Mix 70%	Chrome	765
339922300000100016	Black ash, FSC Mix 70%	Chrome	765
339922600000450016	Walnut lacquer, FSC Mix 70%	Black	765
339929100000551016	Grey oak stained, lacq. FSC Mix 70%	Flint	765

Essential variants are delivered with plastic glides

Order configuration

	Black ash	Beech lacquered / Beech coloured lacquer	Oak lacquered / Oak oiled / Oregon pine aged lacquer	Walnut lacquered	Light grey / Grey	Smoked oak stained, lacquered
Black	810	745	810	765	810	810
Flint	810	745	810	810	810	810
Chrome	765	745	810	810	810	810

Beech coloured lacquer: Nordic blue, Khaki green.

Extra charge for

Glides with felt: +12

Certifications

FSC® certified
EN 1022:2005, EN 16139:2013 (L2)

Model 3397

Trinidad Armchair Seat upholstered



Designed by Nanna Ditzel, 1993

Chair with arms and upholstered seat, non-stackable. Frame of steel tube, seat and back of moulded plywood. Back with CNC-milled cut-outs. Non-removable seat pad upholstered in CMHR or HR foam, covered in fabric or leather. Seat and back mounted with rivets. Mounted with interchangeable plastic glides.

Modeldetails

0,46 m³ Packaging dimensions:
8 kg / 6 kg L: 64 cm W: 71 cm H: 100 cm

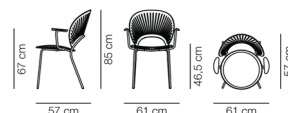

Essential Assortment

Item number	Upholstery	Wood	Frame	Price
339721251301450016	Leather Omni 301, Black	Beech, lacquer, FSC Mix 70%	Black	800
339720251301100016	Leather Omni 301, Black	Oak lacquer FSC Mix 70%	Chrome	885
339722351301100016	Leather Omni 301, Black	Black ash, FSC Mix 70%	Chrome	885
339722651301450016	Leather Omni 301, Black	Walnut lacquer, FSC Mix 70%	Black	885
339729151301551016	Leather Omni 301, Black	Grey oak stained, lacq. FSC Mix 70%	Flint	885

Essential variants are delivered with plastic glides and HR foam

Order configuration

Frame: Chrome, black or flint.

	Black ash	Beech lacquered / Beech coloured lacquered	Oak lacquered / Oak oiled / Oregon pine aged lacquer	Walnut lacquered	Light grey / Grey	Smoked oak stained, lacquered
Fabric group 0	860	795	860	860	860	860
Fabric group 1	925	855	925	925	925	925
Fabric group 2	935	860	935	935	935	935
Fabric group 3	940	870	940	940	940	940
Fabric group 4	945	880	945	945	945	945
Fabric group 5	995	925	995	995	995	995
C.O.M. fabric	925	855	925	925	925	925
Leather group 0	880	805	880	880	880	880
Leather group 1	945	865	945	945	945	945
Leather group 2	995	910	995	995	995	995
Leather group 3	1.030	960	1.030	1.030	1.030	1.030
Leather group 4	1.080	1.010	1.080	1.080	1.080	1.080
Leather group 5	1.245	1.160	1.245	1.245	1.245	1.245
C.O.M. leather	945	865	945	945	945	945

Fabric consumption: 0,5 m. Leather consumption: 0,44 m²

Beech coloured lacquered: Nordic blue, Khaki green.

Extra charge for

Glides with felt: +12

Certifications

FSC® certified
EN 1022:2005, EN 16139:2013 (L2)

Recommended upholstery

Fabric group 0	Connect
Fabric group 1	Grand Linen, Remix, Capture, Bardal, Re-wool, Linara, Natural Linen, Erik
Fabric group 2	Hallingdal, Barnum, Loop, Steelcut Trio, Fiord, Ruskin, Savoy
Fabric group 3	Divina Melange, Vidar, Sunniva, Harald, Foss, Clay
Fabric group 4	Sisu, Safire, Elle, Cotil
Fabric group 5	Grand Mohair, Gentle
Leather group 0	Vice
Leather group 1	Omni
Leather group 2	Primo, Trace
Leather group 3	Max
Leather group 4	Nubuck, Organic, Vegeta, Cera

Model 3400



Trinidad Barstool Wooden seat

Designed by Nanna Ditzel, 1998

Barstool. Frame of steel tube, back of moulded plywood with CNC-milled cut-outs. Seat and back mounted with rivets. Mounted with interchangeable plastic glides.

Modeldetails

0,33 m³ Packaging dimensions:
9 kg / 5,6 kg L: 56,5 cm W: 52 cm H: 114 cm

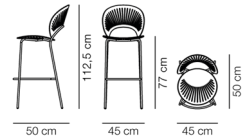

Order configuration

	Black ash	Beech lacquered / Beech coloured lacquer	Oak lacquered / Oak oiled / Oregon pine aged lacquer	Walnut lacquered	Light grey / Grey	Smoked oak stained, lacquered
Black	905	885	905	905	905	905
Flint	905	885	905	905	905	905
Chrome	905	885	905	905	905	905

Beech coloured lacquer: Nordic blue, Khaki green.

Extra charge for

Glides with felt: +12

Certifications

FSC® certified

Model 3401



Trinidad Barstool Seat upholstered

Designed by Nanna Ditzel, 1998

Barstool with upholstered seat. Frame of steel tube, back of moulded plywood, with CNC-milled cut-outs. Non-removable seat pad upholstered in CMHR or HR foam, covered in fabric or leather. Seat and back mounted with rivets. Mounted with interchangeable plastic glides.

Model details

0,33 m³ Packaging dimensions:
10 kg / L: 56,5 cm W: 52 cm H: 114 cm
6,6 kg

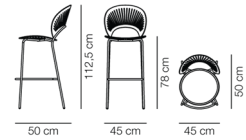

Order configuration

Frame: Chrome, black or flint.

	Black ash	Beech lacquered / Beech coloured lacquer	Oak lacquered / Oak oiled / Oregon pine aged lacquer	Walnut lacquered	Light grey / Grey	Smoked oak stained, lacquered
Fabric group 0	900	885	900	900	900	900
Fabric group 1	970	950	970	970	970	970
Fabric group 2	975	955	975	975	975	975
Fabric group 3	985	965	985	985	985	985
Fabric group 4	995	975	995	995	995	995
Fabric group 5	1.045	1.025	1.045	1.045	1.045	1.045
C.O.M. fabric	970	950	970	970	970	970
Leather group 0	1.000	985	1.000	1.000	1.000	1.000
Leather group 1	1.075	1.060	1.075	1.075	1.075	1.075
Leather group 2	1.120	1.105	1.120	1.120	1.120	1.120
Leather group 3	1.155	1.135	1.155	1.155	1.155	1.155
Leather group 4	1.210	1.195	1.210	1.210	1.210	1.210
Leather group 5	1.395	1.375	1.395	1.395	1.395	1.395
C.O.M. leather	1.075	1.060	1.075	1.075	1.075	1.075

Fabric consumption: 0,5 m. Leather consumption: 0,44 m²

Beech coloured lacquer: Nordic blue, Khaki green.

Extra charge for

Glides with felt: +12

Certifications

FSC® certified

Recommended upholstery

Fabric group 0	Connect
Fabric group 1	Grand Linen, Linara, Bardal, Capture, Remix, Natural Linen, Re-wool, Erik
Fabric group 2	Hallingdal, Savoy, Barnum, Steelcut Trio, Fiord, Ruskin, Loop
Fabric group 3	Harald, Vidar, Clay, Sunniva, Divina Melange, Foss
Fabric group 4	Sisu, Safire, Elle, Cotil
Fabric group 5	Gentle, Grand Mohair
Leather group 0	Vice
Leather group 1	Omni
Leather group 2	Primo, Trace
Leather group 3	Max
Leather group 4	Vegeta, Nubuck, Organic, Cera

**Model
3288**

Trinidad Accessories
Coupling device

Modeldetails

⌘ 0,1 kg /
0,08 kg

Order configuration

For model 3396
and 3398

15

**Model
8101**

Trinidad Accessories
Transport trolley

Modeldetails

0,49 m³ Packaging dimensions:
15 kg / L: 69 cm W: 51,2 cm H: 140 cm
9 kg

Transport trolley for stackable Trinidad chair. Black powder coated steel.

Order configuration

For 2 x 8 chairs

Black	840
-------	-----

**Model
8102**

Trinidad Accessories
Chair suspensions

Modeldetails

⌘ 0,5 kg /
0,5 kg

Chair suspensions in black powder coated steel.

Order configuration

	No template	Template enclosed
Black	80	195

Model 3340

Yksi Armchair Wooden seat



Designed by Thau & Kallio, 2018

Chair with frame in solid wood. Seat and arm/backrest in moulded plywood with beech core and oak top veneer.

Modeldetails

0,26 m³ Packaging dimensions:
8 kg / L: 54 cm W: 59 cm H: 82 cm
5,5 kg

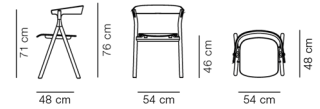

Essential Assortment

Item number	Wood	Price
334000600	Oak black lacquered	660
334010200	Oak lacquer	660

Stackable: 2 pcs.

Extra charge for

QuickClick glides with or without felt (R3340G): +24

Certifications

EN 1022:2005, EN 16139:2013 (L1)

Model 3341

Yksi Armchair Seat upholstered



Designed by Thau & Kallio, 2018

Chair with frame in solid wood. Arm/backrest in moulded plywood with beech core and oak top veneer. Seat in moulded plywood padded with CMHR or HR foam and upholstered in fabric or leather.

Modeldetails

0,26 m³ Packaging dimensions:
8,5 kg / 6 kg L: 54 cm W: 59 cm H: 82 cm

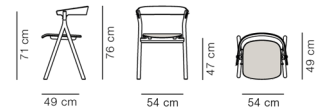

Essential Assortment

Item number	Wood	Upholstery	Price
334100650011000	Oak black lacquered	Leather Vice 11, Black	720
334110250011000	Oak lacquer	Leather Vice 11, Black	720

Essential variants only delivered with HR foam

Order configuration

	Oak lacquered	Oak black lacquered
Fabric group 0	765	790
Fabric group 1	820	850
Fabric group 2	865	895
Fabric group 3	905	935
Fabric group 4	980	1.005
Fabric group 5	1.075	1.100
C.O.M. fabric	820	850
Leather group 0	765	790
Leather group 1	825	850
Leather group 2	875	900
Leather group 3	920	950
Leather group 4	970	1.000
Leather group 5	1.115	1.150
C.O.M. leather	825	850

Fabric consumption: 0,5 m. Leather consumption: 0,6 m²

Extra charge for

QuickClick glides with or without felt (R3340G): +24

Certifications

EN 1022:2005, EN 16139:2013 (L1)

Recommended upholstery

Fabric group 0	Connect
Fabric group 1	Grand Linen, Linara, Bardal, Capture, Remix, Re-wool, Natural Linen, Erik
Fabric group 2	Hallingdal, Savoy, Barnum, Steelcut Trio, Fiord, Ruskin, Loop
Fabric group 3	Harald, Vidar, Clay, Sunniva, Divina Melange, Foss
Fabric group 4	Sisu, Safire, Elle, Cotil
Fabric group 5	Gentle, Grand Mohair
Leather group 0	Vice
Leather group 1	Omni
Leather group 2	Primo, Trace
Leather group 3	Max
Leather group 4	Nubuck, Vegeta, Organic, Cera

Lounge Chairs

Model 6540

A-Chair Wood base



Designed by Jens Risom, 1961

Fully upholstered lounge chair with separate seat cushion. Inner frame of wood, upholstered in CMHR or HR foam, covered in fabric or leather. Fixed legs of solid wood. Removable seat cushion has a foam core in feather wrap. Cover on seat cushion is removable.

Modeldetails

0,65 m³ Packaging dimensions:
28 kg / 20 kg L: 90 cm W: 80 cm H: 90 cm

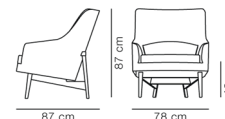

Essential Assortment

Item number	Upholstery	Wood	Price
654019300016200	Re-Wool 198	Walnut lacquer	2.955
654019309010200	Re-Wool 358	Oak lacquer	2.955
654019311010200	Re-Wool 128	Oak lacquer	2.955
654001671016200	Loop 33	Walnut lacquer	3.310

Essential variants only delivered with HR foam

Order configuration

	Oak lacquered	Oak oiled	Oak black lacquered	Walnut lacquered
Fabric group 1	3.045	3.150	3.045	3.360
Fabric group 2	3.310	3.410	3.310	3.605
Fabric group 3	3.545	3.650	3.545	3.825
Fabric group 4	4.005	4.105	4.005	4.255
Fabric group 5	4.595	4.700	4.595	4.810
C.O.M. fabric	3.045	3.150	3.045	3.360
Leather group 1	3.970	4.070	3.970	4.220
Leather group 2	4.635	4.740	4.635	4.845
Leather group 3	5.220	5.325	5.220	5.390
Leather group 4	5.830	5.935	5.830	5.965
C.O.M. leather	3.970	4.070	3.970	4.220

Fabric consumption: 3,1 m. Leather consumption: 5,8 m²

Extra charge for

QuickClick glides with or without felt: +12

Certifications

EN 1022:2005, EN 16139:2013 (L2)

Recommended upholstery

Fabric group 1	Grand Linen, Remix, Capture, Bardal, Re-wool, Linara, Natural Linen, Erik
Fabric group 2	Hallingdal, Barnum, Loop, Steelcut Trio, Fiord, Ruskin
Fabric group 3	Divina Melange, Vidar, Sunniva, Foss, Clay
Fabric group 4	Elle, Sisu, Safire, Cotil
Fabric group 5	Grand Mohair, Gentle
Leather group 1	Omni
Leather group 2	Trace
Leather group 3	Max
Leather group 4	Organic, Vegeta, Cera

Model 6542

A-Chair Metal base



Designed by Jens Risom, 1961

Fully upholstered lounge chair with separate seat cushion. Inner frame of wood, upholstered in CMHR or HR foam, covered in fabric or leather. Fixed legs of chromed or powder coated steel tubes. Removable seat cushion has foam core in feather wrap. Cover on seat cushion is removable.

Modeldetails

0,65 m³ Packaging dimensions:
29 kg / 21 kg L: 90 cm W: 80 cm H: 90 cm

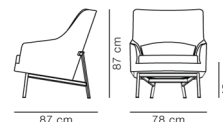

Essential Assortment

Item number	Upholstery	Frame	Price
654219300040012	Re-Wool 198	Black	2.955
654219309040012	Re-Wool 358	Black	2.955
654219311040012	Re-Wool 128	Black	2.955
654201671040012	Loop 33	Black	3.190

Essential variants only delivered with HR foam

Order configuration

Frame: Black or matt chrome.

Fabric group 1	3.045
Fabric group 2	3.310
Fabric group 3	3.545
Fabric group 4	4.005
Fabric group 5	4.595
C.O.M. fabric	3.045
Leather group 1	3.970
Leather group 2	4.635
Leather group 3	5.220
Leather group 4	5.830
C.O.M. leather	3.970

Fabric consumption: 3,1 m. Leather consumption: 5,8 m²

Extra charge for

QuickClick glides with felt: +12

Certifications

EN 1022:2005, EN 16139:2013 (L2)

Recommended upholstery

Fabric group 1	Grand Linen, Remix, Capture, Bardal, Re-wool, Linara, Natural Linen, Erik
Fabric group 2	Hallingdal, Barnum, Loop, Steelcut Trio, Fiord, Ruskin
Fabric group 3	Divina Melange, Vidar, Sunniva, Foss, Clay
Fabric group 4	Elle, Sisu, Safire, Cotil
Fabric group 5	Grand Mohair, Gentle
Leather group 1	Omni
Leather group 2	Trace
Leather group 3	Max
Leather group 4	Organic, Vegeta, Cera

Model 2021

Canvas 21 Chair



Designed by Børge Mogensen, 1968

Lounge chair of solid wood and canvas. Fittings in solid brass. Interchangeable seat, back and armrests made of 100% linen canvas.

Modeldetails

9 kg /
7 kg

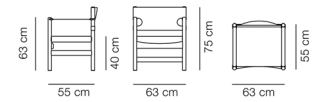

Essential Assortment

Item number	Seat and back	Wood	Price
20212032000000	Natural canvas	Oak soap, FSC Mix 70%	1.415
20212062000000	Natural canvas	Oak light oil, FSC Mix 70%	1.415
20212241000000	Black canvas	Oak black lacquer, FSC Mix 70%	1.415
20212071000000	Black canvas	Smoked oak, oiled, FSC Mix 70%	1.535

Extra charge for

Armrests in black or natural saddle leather: +115

Certifications

FSC® certified

Model P2031

The Canvas Chair Accessories Seat cushion for 2021 & 2031

Modeldetails



Designed by Børge Mogensen

Loose seat cushion for The Canvas Chair and Canvas 21 Chair in HR or CMHR-foam. Seat cushion has removable cover.

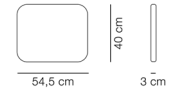

Essential Assortment

Item number	Upholstery	Price
P2031499980	Natural canvas	210
P2031499990	Black canvas	210

Essential variants only delivered with HR foam

Order configuration

Leather group 0	375
Leather group 1	400
Leather group 2	470
Leather group 3	540
Leather group 4	610
Leather group 5	700
C.O.M. leather	400
Canvas black or natural	210

Recommended upholstery

Leather group 0	Vice
Leather group 1	Omni
Leather group 2	Primo, Trace
Leather group 3	Max
Leather group 4	Nubuck, Vegeta, Organic, Cera

Model 2031

The Canvas Chair Lounge chair



Designed by Børge Mogensen, 1970

Lounge chair of solid wood and canvas. Interchangeable seat and back made of 100% linen canvas.

Modeldetails

0,5 m³ Packaging dimensions:
13,8 kg / 8,3 kg L: 81 cm W: 72 cm H: 85 cm

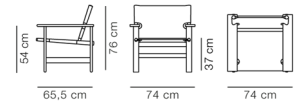

Essential Assortment

Item number	Seat and back	Wood	Price
20312062000	Natural canvas	Oak light oil, FSC Mix 70%	1.770
20312251000	Black canvas	Oak black lacquer, FSC Mix 70%	1.770
20312071000	Black canvas	Smoked oak, oiled, FSC Mix 70%	2.005

Order configuration

Oak soap Canvas natural	Oak light oil Canvas natural	Oak black lacquered Canvas black	Smoked oak, oiled Canvas black
1.965	1.770	1.770	2.005

Certifications

FSC® certified

BS 5852:Part 1:1979 - Match flame equivalent, BS 5852:Part 1:1979 - Smouldering cigarette, EN 1022:2005, EN 16139:2013 (L2)

Model P2031

The Canvas Chair Accessories Seat cushion for 2021 & 2031

Modeldetails



Designed by Børge Mogensen

Loose seat cushion for The Canvas Chair and Canvas 21 Chair in HR or CMHR-foam. Seat cushion has removable cover.

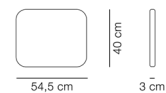

Essential Assortment

Item number	Upholstery	Price
P2031499980	Natural canvas	210
P2031499990	Black canvas	210

Essential variants only delivered with HR foam

Order configuration

Leather group 0	375
Leather group 1	400
Leather group 2	470
Leather group 3	540
Leather group 4	610
Leather group 5	700
C.O.M. leather	400
Canvas black or natural	210

Recommended upholstery

Leather group 0	Vice
Leather group 1	Omni
Leather group 2	Primo, Trace
Leather group 3	Max
Leather group 4	Nubuck, Vegeta, Organic, Cera

**Model
R2031**

The Canvas Chair Accessories
Complete canvas set for 2031

Designed by Børge Mogensen

Complete canvas set in 100% linen canvas.

Order configuration

Canvas naturel	Canvas black
685	685

Model 5000



Corona Chair Swivel base

Designed by Poul M. Volther, 1964

Swivel lounge chair. Seat and back of four separate pads of moulded cold cured foam, fully upholstered in fabric or leather. Spring steel swivel base and frame. Mounted with natural fibre glides, as an alternative to felt.

Modeldetails

0,56 m³ Packaging dimensions:
37 kg / 29 kg L: 95/60 cm W: 85/55 cm H: 52/29 cm

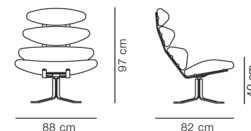

Essential Assortment

Item number	Upholstery	Frame	Price
500050095050000	Leather Max 95, Cognac	Brushed steel	5.320

Essential variants only delivered with HR foam

Order configuration

	Black	Brushed steel
Fabric group 1	3.895	3.895
Fabric group 2	4.010	4.010
Fabric group 3	4.120	4.120
Fabric group 4	4.310	4.310
Fabric group 5	4.685	4.685
C.O.M. fabric	3.895	3.895
Leather group 1	4.965	4.965
Leather group 2	5.265	5.265
Leather group 3	5.440	5.440
Leather group 4	5.760	5.760
Leather group 5	6.920	6.920
C.O.M. leather	4.965	4.965

Fabric consumption: 2 m. Leather consumption: 5 m²

Recommended upholstery

Fabric group 1	Grand Linen, Remix, Capture, Bardal, Re-wool, Linara, Natural Linen, Erik
Fabric group 2	Hallingdal, Barnum, Loop, Steelcut Trio, Fiord, Ruskin
Fabric group 3	Divina Melange, Vidar, Sunniva, Harald, Foss, Clay
Fabric group 4	Elle, Sisu, Safire, Cotil
Fabric group 5	Grand Mohair, Gentle
Leather group 1	Omni
Leather group 2	Primo, Trace
Leather group 3	Max
Leather group 4	Nubuck, Vegeta, Organic, Cera

Model 5002

Corona Ottoman



Designed by Poul M. Volther, 1964

Ottoman of cold cured foam reinforced with steel, fully upholstered in fabric or leather. Spring steel base and frame. Mounted with natural fibre glides, as an alternative to felt.

Modeldetails

0,17 m³ Packaging dimensions:
12 kg / 10 kg L: 75 cm W: 46 cm H: 47 cm

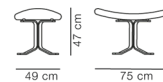

Essential Assortment

Item number	Upholstery	Frame	Price
500250095050000	Leather Max 95, Cognac	Brushed steel	2.005

Essential variants only delivered with HR foam

Order configuration

	Black	Brushed steel
Fabric group 1	1.415	1.415
Fabric group 2	1.465	1.465
Fabric group 3	1.510	1.510
Fabric group 4	1.580	1.580
Fabric group 5	1.745	1.745
C.O.M. fabric	1.415	1.415
Leather group 1	1.775	1.775
Leather group 2	1.900	1.900
Leather group 3	2.095	2.095
Leather group 4	2.360	2.360
Leather group 5	2.820	2.820
C.O.M. leather	1.775	1.775

Fabric consumption: 0,85 m. Leather consumption: 2,5 m²

Recommended upholstery

Fabric group 1	Grand Linen, Remix, Capture, Bardal, Re-wool, Linara, Natural Linen, Erik
Fabric group 2	Hallingdal, Barnum, Loop, Steelcut Trio, Fiord, Ruskin
Fabric group 3	Divina Melange, Vidar, Sunniva, Harald, Foss, Clay
Fabric group 4	Elle, Sisu, Safire, Cotil
Fabric group 5	Grand Mohair, Gentle
Leather group 1	Omni
Leather group 2	Primo, Trace
Leather group 3	Max
Leather group 4	Nubuck, Vegeta, Organic, Cera

Model 2631

Ditzel Lounge Chair Wood base, Sheepskin



Designed by Nanna Ditzel, 1953

Upholstered lounge chair with legs of solid wood mounted with metal thread. Body moulded in cold cured foam, CMHR or HR foam, reinforced with steel frame. Upholstered in sheepskin. Cover is non-removable.

Modeldetails

0,72 m³ Packaging dimensions:
28 kg / 15 kg L: 88 cm W: 80 cm H: 77 cm



Essential Assortment

Item number	Upholstery	Legs	Price
2631499800000102020	Sheepskin Moonlight	Oak lacquer, FSC Mix 70%	3.130
2631499800000101620	Sheepskin Moonlight	Walnut lacquer	3.130

Essential variants only delivered with HR foam

Order configuration

	Oak lacquered	Oak oiled	Smoked oak stained, lacquered	Walnut lacquered
Sheepskin	3.130	3.445	3.445	3.130

Fabric consumption: 2,5 m. Leather consumption: 4 m²

Certifications

Oak is FSC® certified

EN 1022:2005, EN 16139:2013 (L2), ANSI/BIFMA M7.1 Standard Test Method for Determining VOC Emissions from Office (tested with ECO-label fabric and HR-foam)

Model 2632

Ditzel Lounge Chair Wood base



Designed by Nanna Ditzel, 1953

Legs of solid wood mounted with metal thread. Body moulded in cold cured foam, CMHR or HR foam, reinforced with steel frame and topped with batting. Upholstered in fabric or leather with piping in the same upholstery. Available with piping in leather when upholstered in fabric. Cover is non-removable.

Modeldetails

0,72 m³ Packaging dimensions:
27 kg / 14 kg L: 88 cm W: 80 cm H: 77 cm



Essential Assortment

Item number	Upholstery	Legs	Price
26320026890020500	Hallingdal 116	Oak oil, FSC Mix 70%	1.845

Order configuration

	Oak lacquered	Oak oiled	Smoked oak stained, lacquered	Walnut lacquered
Fabric group 1	1.685	1.685	1.685	1.685
Fabric group 2	1.850	1.850	1.850	1.850
Fabric group 3	2.000	2.000	2.000	2.000
Fabric group 4	2.295	2.295	2.295	2.295
Fabric group 5	2.670	2.670	2.670	2.670
C.O.M. fabric	1.685	1.685	1.685	1.685
Leather group 1	2.220	2.220	2.220	2.220
Leather group 2	2.555	2.555	2.555	2.555
Leather group 3	2.885	2.885	2.885	2.885
Leather group 4	3.240	3.240	3.240	3.240
Leather group 5	3.725	3.725	3.725	3.725
C.O.M. leather	2.220	2.220	2.220	2.220

Fabric consumption: 2,5 m. Leather consumption: 4 m²

Two additional seams on front and back when upholstered in leather.

Possibility of upholstery in other textiles in addition to recommended upholstery, two extra seams on front and back can occur.

When upholstered in fabric, piping is available in leather: 88 Black, 95 Cognac or 90 Natural.

Certifications

Oak is FSC® certified

EN 1022:2005, EN 16139:2013 (L2), ANSI/BIFMA M7.1 Standard Test Method for Determining VOC Emissions from Office (tested with ECO-label fabric and HR-foam)

Recommended upholstery

Fabric group 1	Bardal, Capture
Fabric group 2	Hallingdal, Barnum, Ruskin
Fabric group 3	Clay, Divina Melange
Fabric group 4	Sisu, Elle
Fabric group 5	Gentle
Leather group 1	Omni
Leather group 2	Primo, Trace
Leather group 3	Max
Leather group 4	Nubuck, Vegeta, Organic

Model 4850

Eyes Lounge Chair 4-Leg tube base



Designed by Foersom & Hiort-Lorenzen, 2011

Fully upholstered shell in cold cured foam reinforced with a steel frame, covered in fabric or leather. Cover is non-removable. Base of steel tube mounted with plastic glides. Felt glides available.

Modeldetails

0,47 m³ Packaging dimensions:
19 kg / L: 77 cm W: 76 cm H: 80 cm
16 kg

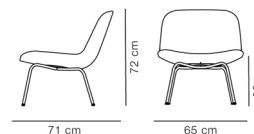

Order configuration

	Black	Brushed stainless steel
Fabric group 0	960	960
Fabric group 1	1.035	1.035
Fabric group 2	1.135	1.135
Fabric group 3	1.185	1.185
Fabric group 4	1.330	1.330
Fabric group 5	1.600	1.600
C.O.M. fabric	1.035	1.035
Leather group 0	1.620	1.620
Leather group 1	1.740	1.740
Leather group 2	1.950	1.950
Leather group 3	2.275	2.275
Leather group 4	2.435	2.435
Leather group 5	2.800	2.800
C.O.M. leather	1.740	1.740

Fabric consumption: 1,5 m. Leather consumption: 3 m²

As standard delivered without decoration buttons.

Extra charge for

Buttons in the same upholstery as the chair or in selected leather: +103

Certifications

EN 1022:2005, EN 16139:2013 (L1)

Recommended upholstery

Fabric group 0	Connect
Fabric group 1	Re-wool, Remix, Bardal, Capture, Linara, Natural Linen, Erik
Fabric group 2	Hallingdal, Barnum, Fiord, Steelcut Trio, Loop, Ruskin
Fabric group 3	Sunniva, Vidar, Foss, Divina Melange, Clay
Fabric group 4	Safire, Sisu, Elle, Cotil 863
Fabric group 5	Gentle
Leather group 0	Vice
Leather group 1	Omni
Leather group 2	Primo, Trace
Leather group 3	Max
Leather group 4	Vegeta, Organic, Nubuck, Cera

Model 4854

Eyes Lounge Chair Wood base



Designed by Foersom & Hiort-Lorenzen, 2011

Fully upholstered shell in cold cured foam reinforced with a steel frame, covered in fabric or leather. Cover is non-removable. Base of solid wood. Glides not included.

Modeldetails

0,5 m³ Packaging dimensions:
13 kg / 10 kg L: 77 cm W: 76 cm H: 80 cm

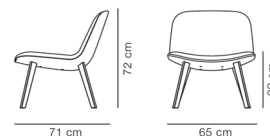

Essential Assortment

Item number	Upholstery	Frame	Price
4854193000006000200	Re-Wool 198	Oak black lacquer	990
48541931100006000100	Re-Wool 128	Oak lacquer	990
48544452400006000100	Gentle 873	Oak lacquer	1.610

Essential variants only delivered with HR foam

Order configuration

	Oak lacquered	Oak black lacquered	Smoked oak stained
Fabric group 0	960	960	960
Fabric group 1	1.035	1.035	1.035
Fabric group 2	1.135	1.135	1.135
Fabric group 3	1.185	1.185	1.185
Fabric group 4	1.330	1.330	1.330
Fabric group 5	1.600	1.600	1.600
C.O.M. fabric	1.035	1.035	1.035
Leather group 0	1.620	1.620	1.620
Leather group 1	1.740	1.740	1.740
Leather group 2	1.950	1.950	1.950
Leather group 3	2.275	2.275	2.275
Leather group 4	2.435	2.435	2.435
Leather group 5	2.800	2.800	2.800
C.O.M. leather	1.740	1.740	1.740

Fabric consumption: 1,5 m. Leather consumption: 3 m²

As standard delivered without decoration buttons.

Extra charge for

Buttons in the same upholstery as the chair or in selected leather: +103

Certifications

EN 1022:2005, EN 16139:2013 (L1)

Recommended upholstery

Fabric group 0	Connect
Fabric group 1	Re-wool, Remix, Bardal, Capture, Linara, Natural Linen, Erik
Fabric group 2	Hallingdal, Barnum, Fiord, Steelcut Trio, Loop, Ruskin
Fabric group 3	Sunniva, Vidar, Foss, Divina Melange, Clay
Fabric group 4	Safire, Sisù, Elle, Cotil 863
Fabric group 5	Gentle
Leather group 0	Vice
Leather group 1	Omni
Leather group 2	Primo, Trace
Leather group 3	Max
Leather group 4	Vegeta, Organic, Nubuck, Cera

Model 4856

Eyes Lounge Armchair Wood base



Designed by Foersom & Hiort-Lorenzen, 2011

Fully upholstered shell in cold cured foam reinforced with a steel frame, covered in fabric or leather. Cover is non-removable. Base and armrests of solid wood. Glides not included.

Modeldetails

0,5 m³ Packaging dimensions:
14 kg / 11 kg L: 77 cm W: 76 cm H: 80 cm

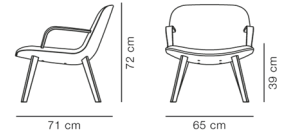

Essential Assortment

Item number	Upholstery	Frame	Price
4856193000006000200	Re-Wool 198	Oak black lacquer	1.485
48561931100006000100	Re-Wool 128	Oak lacquer	1.485
48564452400006000100	Gentle 873	Oak lacquer	2.110

Essential variants only delivered with HR foam

Order configuration

	Oak lacquered	Oak black lacquered	Smoked oak stained
Fabric group 0	1.520	1.520	1.520
Fabric group 1	1.635	1.635	1.635
Fabric group 2	1.735	1.735	1.735
Fabric group 3	1.785	1.785	1.785
Fabric group 4	1.930	1.930	1.930
Fabric group 5	2.320	2.320	2.320
C.O.M. fabric	1.635	1.635	1.635
Leather group 0	2.175	2.175	2.175
Leather group 1	2.340	2.340	2.340
Leather group 2	2.550	2.550	2.550
Leather group 3	2.875	2.875	2.875
Leather group 4	3.035	3.035	3.035
Leather group 5	3.490	3.490	3.490
C.O.M. leather	2.340	2.340	2.340

Fabric consumption: 1,5 m. Leather consumption: 3 m²

As standard delivered without decoration buttons.

Extra charge for

Buttons in the same upholstery as the chair or in selected leather: +103

Recommended upholstery

Fabric group 0	Connect
Fabric group 1	Re-wool, Remix, Bardal, Capture, Linara, Natural Linen, Erik
Fabric group 2	Hallingdal, Barnum, Fiord, Steelcut Trio, Loop, Ruskin
Fabric group 3	Sunniva, Vidar, Foss, Divina Melange, Clay
Fabric group 4	Safire, Sisú, Elle, Cotil 863
Fabric group 5	Gentle
Leather group 0	Vice
Leather group 1	Omni
Leather group 2	Primo, Trace
Leather group 3	Max
Leather group 4	Vegeta, Organic, Nubuck, Cera

Model 4858

Eyes Lounge Chair Swivel base



Designed by Foersom & Hiort-Lorenzen, 2011

Fully upholstered shell in cold cured foam reinforced with a steel frame covered in fabric or leather. Cover is non-removable. 4-point swivel base in polished or powder coated aluminum. Mounted with reversible plastic glides which can be changed to felt when reversed.

Modeldetails

0,5 m³ Packaging dimensions:
19 kg / 16 kg L: 77 cm W: 76 cm H: 80 cm

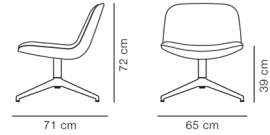

Order configuration

	Black	Polished aluminium
Fabric group 0	1.015	1.015
Fabric group 1	1.090	1.090
Fabric group 2	1.200	1.200
Fabric group 3	1.250	1.250
Fabric group 4	1.405	1.405
Fabric group 5	1.690	1.690
C.O.M. fabric	1.090	1.090
Leather group 0	1.710	1.710
Leather group 1	1.840	1.840
Leather group 2	2.060	2.060
Leather group 3	2.405	2.405
Leather group 4	2.575	2.575
Leather group 5	2.960	2.960
C.O.M. leather	1.840	1.840

Fabric consumption: 1,5 m. Leather consumption: 3 m²

As standard delivered without decoration buttons.

Extra charge for

Buttons in the same upholstery as the chair or in selected leather: +103

Recommended upholstery

Fabric group 0	Connect
Fabric group 1	Re-wool, Remix, Bardal, Capture, Linara, Natural Linen, Erik
Fabric group 2	Hallingdal, Barnum, Fiord, Steelcut Trio, Loop, Ruskin
Fabric group 3	Sunniva, Vidar, Foss, Divina Melange, Clay
Fabric group 4	Safire, Sisu, Elle, Cotil 863
Fabric group 5	Gentle
Leather group 0	Vice
Leather group 1	Omni
Leather group 2	Primo, Trace
Leather group 3	Max
Leather group 4	Vegeta, Organic, Nubuck, Cera

Model 5721

Gomo Lounge Chair



Designed by Hugo Passos, 2023

Fully upholstered lounge chair. Inner construction consists of a wooden shell in moulded plywood and furniture board and seat is supported with webbing. Upholstered in HR or CMHR foam and cover in fabric or leather. Fabric cover is removable. Two base options available: A fixed base with plastic legs with reversible plastic glides which can be changed to felt. A metal swivel base with a black lacquered wooden plate mounted with plastic glides. Felt glides available.

Modeldetails

0,37 m³ Packaging dimensions:
27 kg / 25 kg L: 67 cm W: 72 cm H: 76 cm

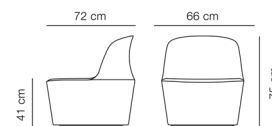

Essential Assortment

Item number	Upholstery	Frame	Price
5721193000005503271	Re-Wool 198	Fixed base, FSC Mix 70%	1.655
57211931100005503271	Re-Wool 128	Fixed base, FSC Mix 70%	1.655
5721193000005503305	Re-Wool 198	Swivel base, FSC Mix 70%	1.890
57211931100005503305	Re-Wool 128	Swivel base, FSC Mix 70%	1.890
5721499800005503271	Sheepskin Moonlight	Fixed base, FSC Mix 70%	3.065
5721499800005503305	Sheepskin Moonlight	Swivel base, FSC Mix 70%	3.305

Essential variants are delivered with plastic glides and HR foam

Order configuration

	Fixed base	Swivel base
Fabric group 0	1.555	1.775
Fabric group 1	1.670	1.910
Fabric group 2	1.780	2.015
Fabric group 3	1.885	2.115
Fabric group 4	2.065	2.290
Fabric group 5	2.420	2.640
C.O.M. fabric	1.670	1.910
Leather group 0	2.035	2.295
Leather group 1	2.215	2.475
Leather group 2	2.390	2.645
Leather group 3	2.600	2.845
Leather group 4	2.975	3.220
Leather group 5	3.630	3.870
C.O.M. leather	2.215	2.475
Sheepskin	3.065	3.305

Fabric consumption: 1,9 m. Leather consumption: 3,8 m²

When upholstered in velvet the stitching will not be visible.

Extra charge for

Return function base: +47

Certifications

FSC® certified

EU Ecolabel variants: Fixed or Swivel base together with HR foam and upholstery in Connect, Remix, Re-wool, Steelcut Quartet, Vidar, Tonus or Wave fabric
ANSI/BIFMA X5.4-2020

Recommended upholstery

Fabric group 0	Connect
Fabric group 1	Grand Linen, Capture, Re-wool, Bardal, Linara, Remix, Erik
Fabric group 2	Hallingdal, Barnum, Steelcut Trio, Ruskin, Fiord, Loop
Fabric group 3	Foss, Sunniva, Divina Melange, Vidar, Clay
Fabric group 4	Safire, Sisu, Elle
Fabric group 5	Gentle
Leather group 0	Vice
Leather group 1	Omni
Leather group 2	Primo, Trace
Leather group 3	Max
Leather group 4	Vegeta, Nubuck, Organic

Model P5721

Gomo Accessories Loose cover for Gomo Lounge Chair

Modeldetails



Designed by Hugo Passos, 2023

Loose cover for re-upholstery of Gomo Chair. Please note there will not be visible stitching in velour textiles.
Professional assistance is recommended.

Order configuration

Fabric group 0	500
Fabric group 1	535
Fabric group 2	570
Fabric group 3	600
Fabric group 4	650
Fabric group 5	765
C.O.M. fabric	535

Fabric consumption: 1,9 m

Recommended upholstery

Fabric group 0	Connect
Fabric group 1	Grand Linen, Capture, Re-wool, Bardal, Linara, Remix, Erik
Fabric group 2	Hallingdal, Barnum, Steelcut Trio, Ruskin, Fiord, Loop
Fabric group 3	Foss, Sunniva, Divina Melange, Vidar, Clay
Fabric group 4	Safire, Sisu, Cotil, Elle
Fabric group 5	Gentle

Model 2229

The Hunting Chair Lounge chair



Designed by Børge Mogensen, 1950

Lounge chair of solid wood and saddle leather. Interchangeable seat and back made in vegetable tanned saddle leather with metal buckles. Leather seat has canvas backing. Saddle straps can be tightened as the leather expands through use.

Modeldetails

0,45 m³ Packaging dimensions:
13 kg / L: 74 cm W: 88 cm H: 74 cm
10,5 kg

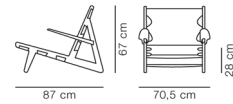

Essential Assortment

Item number	Upholstery	Wood	Price
222900650501	Leather, black	Oak black lacquered	4.700
222910750502	Leather, cognac	Oak light oil	4.700
222910350500	Leather, natural	Oak soap	5.185
222910950501	Leather, black	Smoked oak, oiled	5.545

Order configuration

	Oak soap	Oak oiled	Oak light oil	Oak black lacquered	Smoked oak, oiled
Natural leather	5.185	5.620	5.620	5.620	6.465
Black leather	5.070	5.070	5.070	4.700	5.545
Cognac leather	5.070	5.070	4.700	5.070	5.835

Certifications

EN 1022:2005, EN 16139:2013 (L1)

**Model
P2229**

The Hunting Chair Accessories

Complete leather set for 2229

Designed by Børge Mogensen

Complete leather set made in vegetable tanned saddle leather with metal buckles. Leather seat has canvas backing. Saddle straps can be tightened as the leather expands through use.

Order configuration

Natural leather	Black leather	Cognac leather
3.215	2.620	2.620

Model 2711

Jota Lounge Chair



Designed by Jasper Morrison, 2024

Fully upholstered lounge chair with internal frame of wood and seat supported with supportive webbing. Available with cover in fabric where seat and back cushions are removable covers while cover on frame is fixed. Cushions are with down and foam granulate mix in separate chambers, in addition seat cushion is made with a foam core. Cover is done with piping on gables and french stitching details on cushions. Mounted with oak legs.

Modeldetails

0,92 m³ Packaging dimensions:
49 kg / 38,5 kg L: 99 cm W: 82 cm H: 113 cm

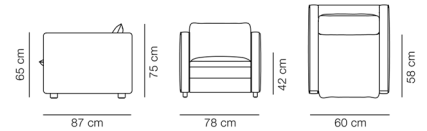

Order configuration

Legs: wooden legs in either Oak light oil, Oak lacquered or oak black lacquered.

Fabric group 1	2.365
Fabric group 2	2.610
Fabric group 3	2.850
Fabric group 4	3.210
Fabric group 5	4.070
C.O.M. fabric	2.365

Fabric consumption: 5,5 m
Delivery from February 2025

Certifications

FSC® certified

Recommended upholstery

Fabric group 1	Bardal, Capture, Re-wool
Fabric group 2	Barnum, Steelcut Trio, Fiord, Ruskin, Loop
Fabric group 3	Vidar, Clay, Divina Melange
Fabric group 4	Sisu, Elle, Safire

Model P2711

Decorative cushion



Designed by Jasper Morrison, 2024

Decorative cushion with french stitching details for Jota. Down and foam granulate mix filling. Removable cover in fabric.

Modeldetails

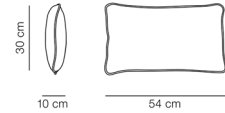

Order configuration

Fabric group 1	125
Fabric group 2	150
Fabric group 3	170
Fabric group 4	205
Fabric group 5	290
C.O.M. fabric	125

Fabric consumption: 0,65 m

Delivery from February 2025

Recommended upholstery

Fabric group 1	Bardal, Capture, Re-wool
Fabric group 2	Barnum, Steelcut Trio, Fiord, Ruskin, Loop
Fabric group 3	Vidar, Clay, Divina Melange
Fabric group 4	Sisu, Elle, Safire

Model 2204



Mogensen Wing Chair Easy Chair

Designed by Børge Mogensen, 1963

Fully upholstered easy chair with piping in all stitches. Available in leather or fabric. Fixed legs of solid wood, built into the wood internal frame. Seat is supported with jute and rubber band webbing. Separate seat cushion with removable covers. Please specify cushion type. Cushions are either with foam core with down wrap or filled with a foam and down mix in separte chambers.

Modeldetails

0,95 m³ Packaging dimensions:
65 kg / 29 kg L: 96 cm W: 77 cm H: 129 cm

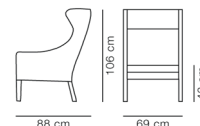

Essential Assortment

Item number	Upholstery	Wood	Price
22041035009010	Leather Vegeta 90, Natural	Oak soap	8.865
22041075084110	Leather Cera 905, Russet brown	Oak light oil	8.865

Essential variants only delivered with HR foam

Order configuration

	Oak soap	Oak oiled	Oak light oil	Oak black lacquered	Walnut oiled
Fabric group 1	5.590	5.590	5.590	5.590	5.590
Fabric group 2	5.920	5.920	5.920	5.920	5.920
Fabric group 3	6.230	6.230	6.230	6.230	6.230
Fabric group 4	6.705	6.705	6.705	6.705	6.705
Fabric group 5	7.790	7.790	7.790	7.790	7.790
Leather group 2	7.515	7.515	7.515	7.515	7.515
Leather group 3	8.420	8.420	8.420	8.420	8.420
Leather group 4	9.655	9.655	9.655	9.655	9.655
Leather group 5	11.055	11.055	11.055	11.055	11.055

Fabric consumption: 5,8 m. Leather consumption: 11,61 m²

Recommended upholstery

Fabric group 1	Bardal, Linara, Capture, Remix, Re-wool, Grand Linen, Erik
Fabric group 2	Hallingdal, Fiord, Ruskin, Savoy, Barnum, Steelcut Trio, Loop
Fabric group 3	Divina Melange, Vidar, Sunniva, Clay, Foss
Fabric group 4	Sisu, Safire
Fabric group 5	Gentle
Leather group 2	Primo, Trace
Leather group 3	Max
Leather group 4	Vegeta, Nubuck, Organic, Cera

Model 2207

Mogensen Club Chair Lounge Chair



Designed by Børge Mogensen, 1963

Fully upholstered lounge chair with piping in all stitches. Available in leather or fabric. Fixed legs of solid wood, built into the wood internal frame. Seat is supported with jute and rubber band webbing. Separate seat and back cushions with removable covers. Please specify cushion type. Cushions are either with foam core with down wrap or filled with a foam and down mix in separate chambers

Model details

0,53 m³ Packaging dimensions:
31 kg / 24 kg L: 86 cm W: 73 cm H: 86 cm

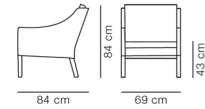

Essential Assortment

Item number	Upholstery	Wood	Price
22071035009010	Leather Vegeta 90, Natural	Oak soap	6.500
22071075084110	Leather Cera 905, Russet brown	Oak light oil	6.500

Essential variants only delivered with HR foam

Order configuration

	Oak soap	Oak oiled	Oak light oil	Oak black lacquered	Walnut oiled
Fabric group 1	4.055	4.055	4.055	4.055	4.055
Fabric group 2	4.345	4.345	4.345	4.345	4.345
Fabric group 3	4.620	4.620	4.620	4.620	4.620
Fabric group 4	5.035	5.035	5.035	5.035	5.035
Fabric group 5	5.985	5.985	5.985	5.985	5.985
Leather group 2	5.450	5.450	5.450	5.450	5.450
Leather group 3	6.145	6.145	6.145	6.145	6.145
Leather group 4	7.085	7.085	7.085	7.085	7.085
Leather group 5	8.720	8.720	8.720	8.720	8.720

Fabric consumption: 5 m. Leather consumption: 8,71 m²

Recommended upholstery

Fabric group 1	Bardal, Linara, Capture, Remix, Re-wool, Grand Linen, Erik
Fabric group 2	Hallingdal, Fiord, Ruskin, Savoy, Barnum, Steelcut Trio, Loop
Fabric group 3	Divina Melange, Vidar, Sunniva, Clay, Foss
Fabric group 4	Sisu, Safire
Fabric group 5	Gentle
Leather group 2	Primo, Trace
Leather group 3	Max
Leather group 4	Vegeta, Nubuck, Organic, Cera

Model 2202

Mogensen Ottoman



Designed by Børge Mogensen, 1963

Fully upholstered ottoman with piping in all stitches. Available in leather or fabric. Fixed legs of solid wood, built into the wood internal frame. Seat is supported with polyamide webbing. Separate seat cushion with removable cover. Please specify cushion type. Cushions are either with foam core with down wrap or filled with a foam and down mix in separate chambers

Modeldetails

0,2 m³ Packaging dimensions:
11 kg / 9 kg L: 60 cm W: 60 cm H: 55 cm

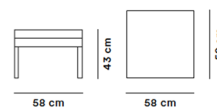

Essential Assortment

Item number	Upholstery	Wood	Price
22021035009010	Leather Vegeta 90, Natural	Oak soap	2.360
22021075084110	Leather Cera 905, Russet brown	Oak light oil	2.360

Essential variants only delivered with HR foam

Order configuration

	Oak soap	Oak oiled	Oak light oil	Oak black lacquered	Walnut oiled
Fabric group 1	1.825	1.825	1.825	1.825	1.825
Fabric group 2	1.970	1.970	1.970	1.970	1.970
Fabric group 3	2.105	2.105	2.105	2.105	2.105
Fabric group 4	2.310	2.310	2.310	2.310	2.310
Fabric group 5	2.760	2.760	2.760	2.760	2.760
Leather group 2	2.175	2.175	2.175	2.175	2.175
Leather group 3	2.420	2.420	2.420	2.420	2.420
Leather group 4	2.650	2.650	2.650	2.650	2.650
Leather group 5	3.040	3.040	3.040	3.040	3.040

Fabric consumption: 2,5 m. Leather consumption: 3,13 m²

Recommended upholstery

Fabric group 1	Bardal, Linara, Capture, Remix, Re-wool, Grand Linen, Erik
Fabric group 2	Hallingdal, Fiord, Ruskin, Savoy, Barnum, Steelcut Trio, Loop
Fabric group 3	Divina Melange, Vidar, Sunniva, Clay, Foss
Fabric group 4	Sisu, Safire
Fabric group 5	Gentle
Leather group 2	Primo, Trace
Leather group 3	Max
Leather group 4	Vegeta, Nubuck, Organic, Cera

Model 7421

Mono Pouf Ø39 cm



Designed by Due & Trampedach, 2020

Fully upholstered pouf with piping in all stitches. Inner frame of wood, seat undercarriage with webbing. Base in black lacquered MDF mounted with plastic glides. Upholstered with CMHR or HR foam. Available in fabric or leather. The cover is non-removable.

Modeldetails

0,1 m³ Packaging dimensions:
7,5 kg / 5,6 kg L: 44 cm W: 44 cm H: 50 cm

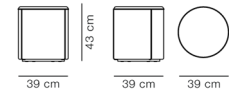

Order configuration

Fabric group 1	685
Fabric group 2	765
Fabric group 3	840
Fabric group 4	975
Fabric group 5	1.160
C.O.M. fabric	685
Leather group 1	1.040
Leather group 2	1.210
Leather group 3	1.385
Leather group 4	1.545
Leather group 5	1.775
C.O.M. leather	1.040

Fabric consumption: 1,3 m. Leather consumption: 2,4 m²

Certifications

EN 1022:2005, EN 16139:2013 (L2)

Recommended upholstery

Fabric group 0	Connect
Fabric group 1	Grand Linen, Remix, Capture, Bardal, Re-wool, Linara, Natural Linen, Erik
Fabric group 2	Hallingdal, Barnum, Loop, Steelcut Trio, Fiord, Ruskin, Savoy
Fabric group 3	Divina Melange, Vidar, Sunniva, Harald, Foss, Clay
Fabric group 4	Sisu, Safire, Elle, Cotil
Fabric group 5	Grand Mohair, Gentle
Leather group 0	Vice
Leather group 1	Omni
Leather group 2	Primo, Trace
Leather group 3	Max
Leather group 4	Nubuck, Organic, Vegeta, Cera

Model 7423

Mono Pouf Ø55 cm



Designed by Due & Trampedach, 2020

Fully upholstered pouf with piping in all stitches. Inner frame of wood, seat undercarriage with webbing. Base in black lacquered MDF mounted with plastic glides. Upholstered with CMHR or HR foam. Available in fabric or leather. The cover is non-removable.

Modeldetails

0,17 m³ Packaging dimensions:
11 kg / 8,2 kg L: 61 cm W: 61 cm H: 45 cm

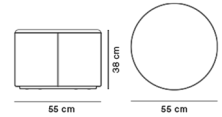

Order configuration

Fabric group 1	765
Fabric group 2	850
Fabric group 3	925
Fabric group 4	1.070
Fabric group 5	1.260
C.O.M. fabric	765
Leather group 1	1.135
Leather group 2	1.315
Leather group 3	1.500
Leather group 4	1.695
Leather group 5	1.950
C.O.M. leather	1.135

Fabric consumption: 1,4 m. Leather consumption: 3,2 m²

Certifications

EN 1022:2005, EN 16139:2013 (L2)

Recommended upholstery

Fabric group 0	Connect
Fabric group 1	Grand Linen, Remix, Capture, Bardal, Re-wool, Linara, Natural Linen, Erik
Fabric group 2	Hallingdal, Barnum, Loop, Steelcut Trio, Fiord, Ruskin, Savoy
Fabric group 3	Divina Melange, Vidar, Sunniva, Harald, Foss, Clay
Fabric group 4	Sisu, Safire, Elle, Cotil
Fabric group 5	Grand Mohair, Gentle
Leather group 0	Vice
Leather group 1	Omni
Leather group 2	Primo, Trace
Leather group 3	Max
Leather group 4	Nubuck, Organic, Vegeta, Cera

Model 4372

Pato Lounge Sledge base



Designed by Welling / Ludvik, 2016

Fully upholstered lounge chair. Frame of solid steel, chromed or powder coated. Inner shell of plywood with CMHR or HR foam, covered in fabric or leather. Cover is non-removable. Mounted with plastic glides.

Modeldetails

0,38 m³ Packaging dimensions:
15 kg / 9 kg L: 84 cm W: 73 cm H: 87 cm

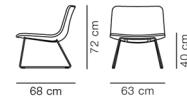

Order configuration

Frame: Chrome or black.

Fabric group 0	840
Fabric group 1	910
Fabric group 2	1.075
Fabric group 3	1.220
Fabric group 4	1.485
Fabric group 5	1.635
C.O.M. fabric	910
Leather group 0	960
Leather group 1	1.035
Leather group 2	1.275
Leather group 3	1.585
Leather group 4	1.740
Leather group 5	2.005
C.O.M. leather	1.035

Fabric consumption: 1,5 m. Leather consumption: 2,5 m²

Other frame colours by quotation.

Extra charge for

Glides with felt: +12

Certifications

FSC® certified
EN 1022:2005, EN 16139:2013 (L1)

Recommended upholstery

Fabric group 0	Connect
Fabric group 1	Grand Linen, Linara, Bardal, Capture, Remix, Re-wool, Natural Linen, Erik
Fabric group 2	Barnum, Hallingdal, Savoy, Steelcut Trio, Fiord, Ruskin, Loop
Fabric group 3	Harald, Vidar, Clay, Sunniva, Divina Melange, Foss
Fabric group 4	Sisu, Elle, Safire, Cotil
Fabric group 5	Gentle, Grand Mohair
Leather group 0	Vice
Leather group 1	Omni
Leather group 2	Primo, Trace
Leather group 3	Max
Leather group 4	Nubuck, Organic, Vegeta, Cera

Model 8805

Savannah Lounge Chair Petit



Designed by Monica Förster, 2022

Lounge chair with upholstered cushions. External frame of solid wood mounted with non-removable upholstery leather, fabric or 100% linen canvas. Cushions of cold cured foam upholstered in fabric. Cover is non-removable on frame and back. Cover on seat cushion is removable.

Modeldetails

0,45 m³ Packaging dimensions:
30 kg / 23 kg L: 76 cm W: 74 cm H: 77 cm

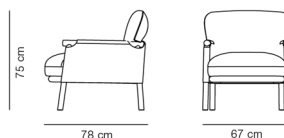

Order configuration

Frame: Oak light oil or oak black lacquered.

	Cushions: Fabric gr. 1	Cushions: Fabric gr. 2	Cushions: Fabric gr. 3	Cushions: Fabric gr. 4	Cushions: Fabric gr. 5	Cushions: Fabric COM
Leather group 1	3.380	3.495	3.610	3.800	4.070	3.380
Leather group 2	3.450	3.565	3.680	3.870	4.140	3.450
Leather group 3	3.550	3.665	3.780	3.970	4.240	3.550
Leather group 4	3.650	3.765	3.880	4.070	4.340	3.650
C.O.M. leather	3.380	3.495	3.610	3.800	4.070	3.380
Canvas black or natural	3.300	3.415	3.530	3.720	3.990	3.300

Fabric consumption: 3,2 m

Fabric consumption on frame: 1,5 m.

Leather consumption on frame: 3 m²

Certifications

EN 1022:2005, EN 16139:2013 (L2), ANSI/BIFMA M7.1 Standard Test Method for Determining VOC Emissions from Office (tested with ECO-label fabric and HR-foam)

Recommended upholstery

Fabric group 1	Bardal, Re-wool, Capture, Grand Linen, Erik
Fabric group 2	Hallingdal, Fiord, Steelcut Trio, Ruskin, Barnum, Loop
Fabric group 3	Sunniva, Vidar, Divina Melange, Clay
Fabric group 4	Sisu, Safire, Elle
Fabric group 5	Gentle
Leather group 0	Vice
Leather group 1	Omni
Leather group 2	Primo, Trace
Leather group 3	Max
Leather group 4	Vegeta, Nubuck, Organic

Model 8801

Savannah Lounge Chair



Designed by Monica Förster, 2015

Lounge chair with upholstered cushions. External frame of solid wood mounted with non-removable upholstery leather, fabric or 100% linen canvas. Cushions of cold cured foam upholstered in fabric. Cover is non-removable on frame and back. Cover on seat cushion is removable.

Modeldetails

0,9 m³ Packaging dimensions:
34 kg / 29 kg L: 111 cm W: 98 cm H: 82 cm

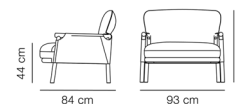

Order configuration

Frame: Oak light oil or oak black lacquered.

	Cushions: Fabric gr. 1	Cushions: Fabric gr. 2	Cushions: Fabric gr. 3	Cushions: Fabric gr. 4	Cushions: Fabric gr. 5	Cushions: Fabric COM
Leather group 1	4.150	4.380	4.485	4.815	5.765	4.150
Leather group 2	4.220	4.450	4.560	4.885	5.835	4.220
Leather group 3	4.325	4.550	4.660	4.990	5.935	4.325
Leather group 4	4.425	4.655	4.765	5.095	6.040	4.425
C.O.M. leather	4.150	4.380	4.485	4.815	5.765	4.150
Canvas black or natural	4.070	4.295	4.405	4.735	5.680	4.070

Fabric consumption: 3,2 m

Fabric consumption on frame: 1,5 m.

Leather consumption on frame: 3,5 m²

Note - arm cushions have to be ordered separately (P8801).

Certifications

EN 1022:2005, EN 16139:2013 (L2), ANSI/BIFMA M7.1 Standard Test Method for Determining VOC Emissions from Office (tested with ECO-label fabric and HR-foam)

Recommended upholstery

Fabric group 1	Bardal, Re-wool, Capture, Grand Linen, Erik
Fabric group 2	Hallingdal, Fiord, Steelcut Trio, Ruskin, Barnum, Loop
Fabric group 3	Sunniva, Vidar, Divina Melange, Clay
Fabric group 4	Sisu, Safire, Elle
Fabric group 5	Gentle
Leather group 0	Vice
Leather group 1	Omni
Leather group 2	Primo, Trace
Leather group 3	Max
Leather group 4	Vegeta, Nubuck, Organic

Model 2226

The Spanish Chair Lounge chair



Designed by Børge Mogensen, 1958

Lounge chair of solid wood and saddle leather. Interchangeable seat and back made in vegetable tanned saddle leather with metal buckles. Leather seat has canvas backing. Saddle straps can be tightened as the leather expands through use.

Modeldetails

0,41 m³ Packaging dimensions:
16,5 kg / L: 64 cm W: 87 cm H: 73 cm
10,7 kg

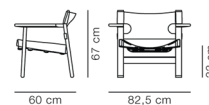

Essential Assortment

Item number	Upholstery	Wood	Price
222600650501	Leather, black	Oak black lacquered	3.545
222620650502	Leather, cognac	Oak light oil, FSC Mix 70%	3.545
222620350500	Leather, natural	Oak soap, FSC Mix 70%	4.135
222616450501	Leather, black	Walnut oiled	4.370
222616450510	Leather dark brown	Walnut oiled	4.370
222620750501	Leather, black	Smoked oak, oiled, FSC Mix 70%	4.370

Order configuration

	Oak soap	Oak oiled	Oak light oil	Oak black lacquered	Smoked oak, oiled	Walnut oiled
Natural leather	4.135	4.520	4.520	4.520	5.285	5.285
Black leather	3.865	3.865	3.865	3.545	4.370	4.370
Cognac leather	3.865	3.865	3.545	3.865	4.605	4.605
Dark Brown leather	3.865	3.865	3.865	3.865	4.605	4.370

Certifications

Oak (soap, oiled, light oil, smoked oiled) is FSC® certified

EN 1021-1:2006 - Smouldering cigarette, EN 1021-2:2006 - Match flame equivalent, EN 1022:2005, EN 16139:2013 (L2), EN ISO 6941:2003

**Model
P2226**

The Spanish Chair Accessories
Complete leather set for 2226



Designed by Børge Mogensen

Complete leather set with interchangeable seat and back made in vegetable tanned saddle leather with metal buckles. Leather seat has canvas backing. Saddle straps can be tightened as the leather expands through use.

Order configuration

	Natural leather	Black leather	Cognac leather	Dark Brown leather
	2,515	1,820	1,820	1,820

Model 1710

Spine Lounge Chair



Designed by Space Copenhagen, 2016

Lounge chair with legs of solid wood. Wooden seat shell of moulded plywood. The cushion in CMHR or HR foam. Available in fabric or leather, with piping in all stitches. Cushions are kept in place with Velcro fixtures and are removable for cleaning.

Modeldetails

0,56 m³ Packaging dimensions:
45 kg / 34 kg L: 86 cm W: 86 cm H: 76 cm

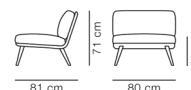

Essential Assortment

Item number	Upholstery	Wood	Price
171020200044807	Grand Linen Naturel 0024	Oak lacquer FSC Mix 70%	3.615
171022300050088	Leather Primo 88, Black	Black ash, FSC Mix 70%	3.615
171022300050841	Leather Cera 905, Russet brown	Black ash, FSC Mix 70%	4.820

Essential variants only delivered with HR foam

Order configuration

	Oak lacquered	Black ash	Smoked oak stained, lacquered
Fabric group 0	3.850	3.465	4.070
Fabric group 1	4.140	3.725	4.555
Fabric group 2	4.345	3.935	4.780
Fabric group 3	4.675	4.265	4.865
Fabric group 4	5.225	4.810	5.415
Fabric group 5	5.670	5.255	5.860
C.O.M. fabric	4.140	3.725	4.330
Leather group 0	4.045	3.665	4.265
Leather group 1	4.350	3.940	4.540
Leather group 2	4.760	4.350	4.950
Leather group 3	5.140	4.725	5.330
Leather group 4	5.655	5.200	5.800
Leather group 5	6.500	5.980	6.580
C.O.M. leather	4.350	3.940	4.540

Fabric consumption: 2,9 m. Leather consumption: 5 m²

QuickClick glides with felt upon request (R1730).

Certifications

FSC® certified

EN 1022:2005, EN 16139:2013 (L2)

Recommended upholstery

Fabric group 1	Grand Linen, Linara, Bardal, Capture, Remix, Re-wool, Natural Linen, Erik
Fabric group 2	Hallingdal, Savoy, Barnum, Steelcut Trio, Fiord, Ruskin, Loop
Fabric group 3	Harald, Vidar, Clay, Sunniva, Divina Melange, Foss
Fabric group 4	Sisu, Safire, Cotil, Elle
Fabric group 5	Gentle, Grand Mohair
Leather group 0	Vice
Leather group 1	Omni
Leather group 2	Primo, Trace
Leather group 3	Max
Leather group 4	Nubuck, Organic, Vegeta, Cera

Model 1711

Spine Lounge Chair Petit



Designed by Space Copenhagen, 2016

Lounge chair with legs of solid wood. Wooden seat shell of moulded plywood. Cushions in CMHR or HR foam. Available in fabric or leather, with piping in all stitches. Cushions are kept in place with Velcro fixtures and are removable for cleaning.

Modeldetails

0,38 m³ Packaging dimensions:
29 kg / 24 kg L: 75,5 cm W: 69,5 cm H: 72,5 cm

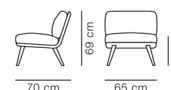

Essential Assortment

Item number	Upholstery	Wood	Price
171120244807000	Grand Linen Naturel 0024	Oak lacquer FSC Mix 70%	2.530
171122350088000	Leather Primo 88, Black	Black ash, FSC Mix 70%	2.650
171122350841000	Leather Cera 905, Russet brown	Black ash, FSC Mix 70%	3.375

Essential variants only delivered with HR foam

Order configuration

	Oak lacquered	Black ash	Smoked oak stained, lacquered
Fabric group 0	2.540	2.095	2.455
Fabric group 1	2.730	2.255	2.615
Fabric group 2	2.870	2.395	2.755
Fabric group 3	3.050	2.575	2.935
Fabric group 4	3.275	2.795	3.160
Fabric group 5	3.650	3.170	3.535
C.O.M. fabric	2.730	2.255	2.615
Leather group 0	2.655	2.225	2.590
Leather group 1	2.855	2.395	2.755
Leather group 2	3.165	2.710	3.070
Leather group 3	3.575	3.120	3.480
Leather group 4	3.935	3.430	3.790
Leather group 5	4.525	3.945	4.305
C.O.M. leather	2.855	2.395	2.755

Fabric consumption: 2,7 m. Leather consumption: 4,2 m²

Extra charge for

QuickClick glides with or without felt: +12

Certifications

FSC® certified
EN 1022:2005, EN 16139:2013 (L2)

Recommended upholstery

Fabric group 1	Grand Linen, Linara, Bardal, Capture, Remix, Re-wool, Natural Linen, Erik
Fabric group 2	Hallingdal, Savoy, Barnum, Steelcut Trio, Fiord, Ruskin, Loop
Fabric group 3	Harald, Vidar, Clay, Sunniva, Divina Melange, Foss
Fabric group 4	Sisu, Safire, Cotil, Elle
Fabric group 5	Gentle, Grand Mohair
Leather group 0	Vice
Leather group 1	Omni
Leather group 2	Primo, Trace
Leather group 3	Max
Leather group 4	Nubuck, Organic, Vegeta, Cera

Model 1770

Swoon Lounge Armchair Wood base



Designed by Space Copenhagen, 2016

Fully upholstered lounge chair with solid wood legs mounted with metal thread. Inner shell in moulded high pressure polyurethane foam, reinforced with a steel frame. Removable seat and back cushion of low emission foam, with removable cover. Available in fabric or leather.

Modeldetails

0,93 m³ Packaging dimensions:
32,8 kg / L: 94 cm W: 94 cm H: 105 cm
18,6 kg

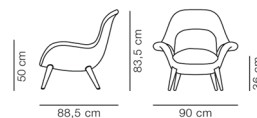

Essential Assortment

Item number	Upholstery	Legs	Price
17700772200005202000	Sunniva 242	Oak lacquer, FSC Mix 70%	2.710
17700773900005162000	Sunniva 717	Walnut lacquer	2.710
17700774500005224000	Sunniva 192	Oak black lacquer FSC Mix 70%	2.710
17700167500005202000	Elle 230	Oak lacquer, FSC Mix 70%	2.950

Essential variants only delivered with HR foam

Order configuration

Legs: Walnut lacquered, oak lacquered, oak oiled, smoked oak stained lacquered or oak black lacquered.

Fabric group 0	2.310
Fabric group 1	2.485
Fabric group 2	2.965
Fabric group 3	3.180
Fabric group 4	3.600
Fabric group 5	4.140
C.O.M. fabric	2.485
Leather group 1	3.310
Leather group 2	3.900
Leather group 3	4.415
Leather group 4	4.950
Leather group 5	5.695
C.O.M. leather	3.310

Fabric consumption: 4,4 m. Leather consumption: 8 m²

Different fabrics on corpus and cushion upon request.

Certifications

Oak is FSC® certified

EN 1022:2005, EN 16139:2013 (L2), ANSI/BIFMA M7.1 Standard Test Method for Determining VOC Emissions from Office (tested with ECO-label fabric and HR-foam)

Recommended upholstery

Fabric group 0	Connect
Fabric group 1	Capture, Re-wool, Bardal, Linara, Remix, Erik
Fabric group 2	Hallingdal, Savoy, Barnum, Steelcut Trio, Ruskin, Fiord, Loop
Fabric group 3	Foss, Sunniva, Harald, Divina Melange, Vidar, Clay
Fabric group 4	Safire, Sisu, Elle
Fabric group 5	Gentle, Grand Mohair
Leather group 1	Omni
Leather group 2	Primo, Trace
Leather group 3	Max
Leather group 4	Vegeta, Nubuck, Organic

Model 1771

Swoon Ottoman Wood base

Designed by Space Copenhagen, 2018

Fully upholstered footstool with solid wood legs mounted with metal thread. Inner shell in moulded polyurethane foam, reinforced with a steel frame. Available in fabric or leather.



Modeldetails

0,15 m³ Packaging dimensions:
13 kg / 9,5 kg L: 55 cm W: 65 cm H: 48 cm



Essential Assortment

Item number	Upholstery	Legs	Price
17710772200005202000	Sunniva 242	Oak lacquer, FSC Mix 70%	900
17710773900005162000	Sunniva 717	Walnut lacquer	900
17710774500005224000	Sunniva 192	Oak black lacquer FSC Mix 70%	900
17710167500005202000	Elle 230	Oak lacquer, FSC Mix 70%	960

Essential variants only delivered with HR foam

Order configuration

Legs: Walnut lacquered, oak lacquered, oak oiled, smoked oak stained lacquered or oak black lacquered.

Fabric group 0	840
Fabric group 1	905
Fabric group 2	990
Fabric group 3	1.050
Fabric group 4	1.175
Fabric group 5	1.340
C.O.M. fabric	905
Leather group 1	1.395
Leather group 2	1.585
Leather group 3	1.780
Leather group 4	1.985
Leather group 5	2.285
C.O.M. leather	1.395

Fabric consumption: 2 m. Leather consumption: 2,5 m²

Certifications

Oak is FSC® certified

EN 1022:2005, EN 16139:2013 (L2), ANSI/BIFMA M7.1 Standard Test Method for Determining VOC Emissions from Office (tested with ECO-label fabric and HR-foam)

Recommended upholstery

Fabric group 0	Connect
Fabric group 1	Capture, Re-wool, Bardal, Linara, Remix, Erik
Fabric group 2	Hallingdal, Savoy, Barnum, Steelcut Trio, Ruskin, Fiord, Loop
Fabric group 3	Foss, Sunniva, Harald, Divina Melange, Vidar, Clay
Fabric group 4	Safire, Sisu, Elle
Fabric group 5	Gentle, Grand Mohair
Leather group 1	Omni
Leather group 2	Primo, Trace
Leather group 3	Max
Leather group 4	Vegeta, Nubuck, Organic

Model 1774

Swoon Lounge Petit Armchair Wood base



Designed by Space Copenhagen, 2019

Fully upholstered lounge chair with solid wood legs mounted with metal thread. Inner shell in moulded high pressure polyurethane foam, reinforced with a steel frame. Removable seat and back cushion of low emission foam, with removable cover. Available in fabric or leather.

Modeldetails

0,61 m³ Packaging dimensions:
19 kg / 13,5 kg L: 82,2 cm W: 83,7 cm H: 89 cm

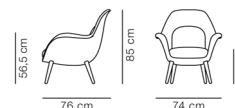

Essential Assortment

Item number	Upholstery	Legs	Price
17740772200005202000	Sunniva 242	Oak lacquer, FSC Mix 70%	2.095
17740773900005162000	Sunniva 717	Walnut lacquer	2.095
17740774500005224000	Sunniva 192	Oak black lacquer FSC Mix 70%	2.095
17740167500005202000	Elle 230	Oak lacquer, FSC Mix 70%	2.460

Essential variants only delivered with HR foam

Order configuration

Legs: Walnut lacquered, oak lacquered, oak oiled, smoked oak stained lacquered or oak black lacquered.

Fabric group 0	1.925
Fabric group 1	2.070
Fabric group 2	2.310
Fabric group 3	2.525
Fabric group 4	2.940
Fabric group 5	3.480
C.O.M. fabric	2.070
Leather group 1	2.335
Leather group 2	2.685
Leather group 3	2.990
Leather group 4	3.315
Leather group 5	3.810
C.O.M. leather	2.335

Fabric consumption: 3,9 m. Leather consumption: 6,5 m²

Different fabrics on corpus and cushion upon request.

Certifications

Oak is FSC® certified

EN 1022:2005, EN 16139:2013 (L2), ANSI/BIFMA M7.1 Standard Test Method for Determining VOC Emissions from Office (tested with ECO-label fabric and HR-foam)

Recommended upholstery

Fabric group 0	Connect
Fabric group 1	Capture, Re-wool, Bardal, Linara, Remix, Erik
Fabric group 2	Hallingdal, Savoy, Barnum, Steelcut Trio, Ruskin, Fiord, Loop
Fabric group 3	Foss, Sunniva, Harald, Divina Melange, Vidar, Clay
Fabric group 4	Safire, Sisu, Elle
Fabric group 5	Gentle, Grand Mohair
Leather group 1	Omni
Leather group 2	Primo, Trace
Leather group 3	Max
Leather group 4	Vegeta, Nubuck, Organic

Model 1776

Swoon Lounge Petit Armchair Swivel base



Designed by Space Copenhagen, 2019

Fully upholstered lounge chair with aluminum swivel base. Inner shell in moulded high pressure polyurethane foam, reinforced with a steel frame. Removable seat and back cushion of low emission foam, with removable cover. Available in fabric or leather. Mounted with reversible plastic glides which can be changed to felt when reversed.

Modeldetails

0,61 m³ Packaging dimensions:
30 kg / 18 kg L: 82,2 cm W: 83,7 cm H: 89 cm



Essential Assortment

Item number	Upholstery	Frame	Price
17760772200005905072	Sunniva 242	Swivel base polished aluminium	2.335
17760773900005451071	Sunniva 717	Swivel base black	2.335
17760774500005451071	Sunniva 192	Swivel base black	2.335
17760167500005905072	Elle 230	Swivel base polished aluminium	2.685

Essential variants only delivered with HR foam

Order configuration

Frame: Polished aluminium or black.

Fabric group 0	2.150
Fabric group 1	2.310
Fabric group 2	2.550
Fabric group 3	2.765
Fabric group 4	3.185
Fabric group 5	3.720
C.O.M. fabric	2.310
Leather group 1	2.610
Leather group 2	2.965
Leather group 3	3.270
Leather group 4	3.590
Leather group 5	4.130
C.O.M. leather	2.610

Fabric consumption: 3,9 m. Leather consumption: 6,5 m²

Different fabrics on corpus and cushion upon request.

Certifications

EN 1022:2005, EN 16139:2013 (L2), ANSI/BIFMA M7.1 Standard Test Method for Determining VOC Emissions from Office (tested with ECO-label fabric and HR-foam)

Recommended upholstery

Fabric group 0	Connect
Fabric group 1	Capture, Re-wool, Bardal, Linara, Remix, Erik
Fabric group 2	Hallingdal, Savoy, Barnum, Steelcut Trio, Ruskin, Fiord, Loop
Fabric group 3	Foss, Sunniva, Harald, Divina Melange, Vidar, Clay
Fabric group 4	Safire, Sisu, Elle
Fabric group 5	Gentle, Grand Mohair
Leather group 1	Omni
Leather group 2	Primo, Trace
Leather group 3	Max
Leather group 4	Vegeta, Nubuck, Organic

Model 1788

Wegner 1788 Lounge Chair



Designed by Hans J. Wegner, 1974

Easy chair with frame of solid wood. Seat supported by jute webbing. Interchangeable seat and back cushions of HR foam, covered in fabric or leather and finished with buttons. Back cushion attached with leather straps. Available in fabric or leather.

Modeldetails

0,45 m³ Packaging dimensions:
15 kg / 10 kg L: 70 cm W: 70 cm H: 92 cm

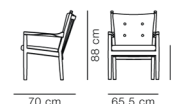

Essential Assortment

Item number	Upholstery	Wood	Price
17880055130130	Leather Omni 301, Black	Black lacquered	2.955
17882031410830	Capture 4201	Oak soap, FSC Mix 70%	2.955
17882031411230	Capture 5201	Oak soap, FSC Mix 70%	2.955
17882034480630	Natural Linen 0003	Oak soap, FSC Mix 70%	2.955
17882030095030	Cotil 863, 53938	Oak soap, FSC Mix 70%	3.130
17882035009530	Leather Max 95, Cognac	Oak soap, FSC Mix 70%	3.250

Essential variants only delivered with HR foam

Order configuration

	Oak soap	Oak oiled	Oak black lacquered
Fabric group 1	3.100	3.305	3.100
Fabric group 2	3.190	3.395	3.190
Fabric group 3	3.305	3.515	3.305
Fabric group 4	3.450	3.655	3.450
Fabric group 5	4.140	4.350	4.140
C.O.M. fabric	3.100	3.305	3.100
Leather group 1	3.115	3.320	3.115
Leather group 2	3.240	3.445	3.240
Leather group 3	3.405	3.610	3.405
Leather group 4	3.745	3.950	3.745
Leather group 5	4.305	4.510	4.305
C.O.M. leather	3.115	3.320	3.115

Fabric consumption: 1,3 m. Leather consumption: 4,2 m²

Extra charge for

QuickClick glides with or without felt (R1788): +12

Certifications

Oak is FSC® certified

Recommended upholstery

Fabric group 1	Grand Linen, Remix, Capture, Bardal, Re-wool, Linara, Natural Linen, Erik
Fabric group 2	Hallingdal, Barnum, Steelcut Trio, Fiord, Ruskin, Savoy
Fabric group 3	Divina Melange, Vidar, Sunniva, Foss, Clay
Fabric group 4	Cotil, Sisu, Elle, Safire
Fabric group 5	Gentle
Leather group 1	Omni
Leather group 2	Primo, Trace
Leather group 3	Max
Leather group 4	Organic, Nubuck, Vegeta, Cera

Model P1788

Wegner 1788 Accessories Cushions for 1788

Designed by Hans J. Wegner

Cushions for Wegner 1788 easy chair. Consists of seat and back cushions of HR foam, covered in fabric or leather and finished with buttons. Back cushion attached with leather straps. Available in fabric or leather.

Order configuration

Fabric group 1	885
Fabric group 2	965
Fabric group 3	1.075
Fabric group 4	1.210
Fabric group 5	1.450
C.O.M. fabric	885
Leather group 1	895
Leather group 2	1.010
Leather group 3	1.165
Leather group 4	1.280
Leather group 5	1.475
C.O.M. leather	895

Fabric consumption: 1,3 m. Leather consumption: 4,2 m²

Recommended upholstery

Fabric group 1	Grand Linen, Linara, Bardal, Capture, Remix, Natural Linen, Re-wool, Erik
Fabric group 2	Hallingdal, Barnum, Steelcut Trio, Fiord, Ruskin, Savoy
Fabric group 3	Vidar, Clay, Sunniva, Divina Melange, Foss
Fabric group 4	Sisu, Cofil, Elle, Safire
Fabric group 5	Gentle
Leather group 1	Omni
Leather group 2	Primo, Trace
Leather group 3	Max
Leather group 4	Nubuck, Vegeta, Organic, Cera

Model 16000



Wegner J16 Rocking Chair

Designed by Hans J. Wegner, 1944

Rocking chair in solid wood. Woven seat of paper cord.

Modeldetails

0,58 m³ Packaging dimensions:
13 kg / 11 kg L: 79 cm W: 64,5 cm H: 113 cm

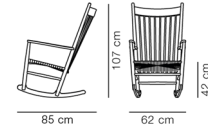

Essential Assortment

Item number	Seat	Wood	Price
1600020325000000	Natural paper cord	Oak soap, FSC Mix 70%	2.410
1600022425000000	Natural paper cord	Oak black lacquer, FSC Mix 70%	2.410
1600020525000000	Natural paper cord	Oak oil, FSC Mix 70%	2.410
1600022426000000	Black paper cord	Oak black lacquer, FSC Mix 70%	2.770
1600016425000000	Natural paper cord	Walnut oiled	3.010

Certifications

Oak is FSC® certified

Model P1600H



Wegner J16 Accessories Cushions for J16

Modeldetails

Designed by Hans J. Wegner

Cushions for Wegner J16 Rocking Chair. Loose seat, back or neck cushions in HR foam with a back of granulated foam.

Essential Assortment

Item number	Type	Upholstery	Price
P1600H03448060	Seat cushion with cover	Natural Linen 0003	235
P1600H13448060	Neck cushion with	Natural Linen 0003	330
P1600H04448060	Back cushion with cover	Natural Linen 0003	350
P1600H03513010	Seat cushion with cover	Leather Omni 301, Black	360
P1600H03513070	Seat cushion with cover	Leather Omni 307, Cognac	360
P1600H13513010	Neck cushion with	Leather Omni 301, Black	390
P1600H13513070	Neck cushion with	Leather Omni 307, Cognac	390
P1600H04513010	Back cushion with cover	Leather Omni 301, Black	470
P1600H04513070	Back cushion with cover	Leather Omni 307, Cognac	470

Essential variants only delivered with HR foam

Order configuration

	Neck cushion	Back cushion	Seat cushion
Fabric group 1	340	395	270
Fabric group 2	330	430	280
Fabric group 3	360	495	315
Fabric group 4	410	590	360
Fabric group 5	525	820	475
C.O.M. fabric	340	395	270
Leather group 1	420	535	370
Leather group 2	470	615	410
Leather group 3	545	745	470
Leather group 4	650	925	555
Leather group 5	830	1.230	700
C.O.M. leather	420	535	370

Recommended upholstery

Fabric group 1	Grand Linen, Linara, Bardal, Capture, Remix, Natural Linen, Re-wool, Erik
Fabric group 2	Hallingdal, Barnum, Steelcut Trio, Fiord, Ruskin
Fabric group 3	Vidar, Sunniva, Divina Melange, Foss
Fabric group 4	Sisu, Cotil
Leather group 0	Vice
Leather group 1	Omni
Leather group 2	Primo, Trace
Leather group 3	Max
Leather group 4	Nubuck, Vegeta, Organic, Cera

Model 16002

Wegner J16 Stool



Designed by Hans J. Wegner, 1950

Footstool in solid wood. Woven seat of paper cord.

Modeldetails

0,1 m³

Packaging dimensions:

5 kg /
4 kg

L: 56 cm W: 40 cm H: 46 cm

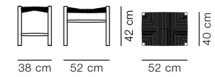

Essential Assortment

Item number	Seat	Wood	Price
1600220325000000	Natural paper cord	Oak soap, FSC Mix 70%	780
1600222425000000	Natural paper cord	Oak black lacquer, FSC Mix 70%	780
1600220525000000	Natural paper cord	Oak oil, FSC Mix 70%	780
1600216425000000	Natural paper cord	Walnut oiled	900
1600222426000000	Black paper cord	Oak black lacquer, FSC Mix 70%	985

Extra charge for

QuickClick glides with or without felt (R16002):

+12

Certifications

Oak is FSC® certified

Model P16002

Wegner J16 Accessories Cushion for J16 Stool

Designed by Hans J. Wegner

Cushions for Wegner J16 Rocking Chair. Loose cushions in foam.

Order configuration

	Cushion
Fabric group 1	265
Fabric group 2	290
Fabric group 3	315
Fabric group 4	340
Fabric group 5	405
C.O.M. fabric	265
Leather group 1	280
Leather group 2	350
Leather group 3	420
Leather group 4	460
Leather group 5	530
C.O.M. leather	280

Fabric consumption: 0,6 m. Leather consumption: 0,84 m²

Recommended upholstery

Fabric group 1	Grand Linen, Linara, Bardal, Capture, Remix, Natural Linen, Re-wool, Erik
Fabric group 2	Hallingdal, Barnum, Steelcut Trio, Fiord, Ruskin
Fabric group 3	Vidar, Sunniva, Divina Melange, Foss
Fabric group 4	Sisu, Cotil
Leather group 1	Omni
Leather group 2	Primo, Trace
Leather group 3	Max
Leather group 4	Nubuck, Vegeta, Organic, Cera

Model 1000

Wegner Ox Chair Easy chair



Designed by Hans J. Wegner, 1960

Fully upholstered easy chair in fabric or leather. Inner frame of solid wood and moulded cold cured foam. Pads at neck and armrest includes piping, available in leather as contrast to fabric upholstery. Stainless steel base. Mounted with plastic glides.

Modeldetails

1,1 m³ Packaging dimensions:
73 kg / 31 kg L: 103 cm W: 97 cm H: 117 cm

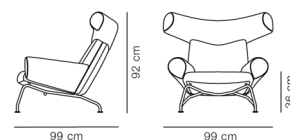

Essential Assortment

Item number	Upholstery	Piping	Frame	Price
1000002680900260100	Hallingdal 116	Leather Max 95, Cognac	Brushed stainless steel	8.690
1000500880909060100	Leather Primo 88, Black	Piping as upholstery	Brushed stainless steel	10.415
1000508410909060100	Leather Cera 905, Russet brown	Piping as upholstery	Brushed stainless steel	11.720

Essential variants only delivered with HR foam

Order configuration

	Black	Brushed stainless steel
Fabric group 1	8.712	8.712
Fabric group 2	9.022	9.022
Fabric group 3	9.167	9.167
Fabric group 4	9.607	9.607
Fabric group 5	11.517	11.517
C.O.M. fabric	8.712	8.712
Leather group 2	11.002	11.002
Leather group 3	11.837	11.837
Leather group 4	12.252	12.252
Leather group 5	14.077	14.077
C.O.M. leather	10.462	10.462

Fabric consumption: 4,5 m. Leather consumption: 13 m²

Not available in Trace leather.

Leather piping for furniture with fabric: +103
Pads for arm and horn in leather for furniture with fabric: +77

Certifications

EN 1022:2005, EN 16139:2013 (L2)

Recommended upholstery

Fabric group 1	Linara, Bardal, Capture, Re-wool, Erik
Fabric group 2	Hallingdal, Barnum, Steelcut Trio, Fiord, Ruskin
Fabric group 3	Vidar, Clay, Sunniva, Divina Melange, Foss
Leather group 2	Primo
Leather group 3	Max
Leather group 4	Nubuck, Vegeta, Organic, Cera

Model 1002

Wegner Ox Ottoman



Designed by Hans J. Wegner, 1960

Fully upholstered footstool in fabric or leather for Ox Chair and Queen Chair. Inner frame of solid wood and moulded cold cured foam. Side pads available in leather as contrast to fabric upholstery. Stainless steel base. Mounted with plastic glides.

Modeldetails

0,17 m³ Packaging dimensions:
13 kg / 11 kg L: 80 cm W: 56 cm H: 38 cm

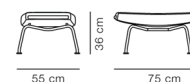

Essential Assortment

Item number	Upholstery	Frame	Price
1002002680900060100	Hallingdal 116	Brushed stainless steel	2.115
1002500880900060100	Leather Primo 88, Black	Brushed stainless steel	2.480
1002508410900060100	Leather Cera 905, Russet brown	Brushed stainless steel	2.600

Essential variants only delivered with HR foam

Order configuration

	Black	Brushed stainless steel
Fabric group 1	2.145	2.145
Fabric group 2	2.210	2.210
Fabric group 3	2.240	2.240
Fabric group 4	2.330	2.330
Fabric group 5	2.795	2.795
C.O.M. fabric	2.145	2.145
Leather group 2	2.615	2.615
Leather group 3	2.790	2.790
Leather group 4	2.875	2.875
Leather group 5	3.305	3.305
C.O.M. leather	2.505	2.505

Fabric consumption: 0,9 m. Leather consumption: 4,5 m²

Not available in Trace leather.

Extra charge for

Side pads in leather for furniture with fabric: +77

Recommended upholstery

Fabric group 1	Linara, Bardal, Capture, Re-wool, Erik
Fabric group 2	Hallingdal, Barnum, Steelcut Trio, Fiord, Ruskin
Fabric group 3	Vidar, Clay, Sunniva, Divina Melange, Foss
Leather group 2	Primo
Leather group 3	Max
Leather group 4	Nubuck, Vegeta, Organic, Cera

Model 1010

Wegner Queen Chair Easy chair



Designed by Hans J. Wegner, 1960

Fully upholstered easy chair in fabric or leather. Inner frame of solid wood and moulded cold cured foam. Piping at backrest and arm pads available in leather as contrast to fabric upholstery. Stainless steel base. Mounted with plastic glides.

Modeldetails

1,1 m³ Packaging dimensions:
71 kg / 28 kg L: 103 cm W: 97 cm H: 117 cm

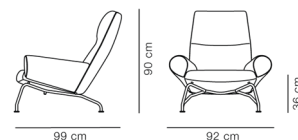

Essential Assortment

Item number	Upholstery	Piping	Frame	Price
1010002680900260100	Hallingdal 116	Leather Max 95, Cognac	Brushed stainless steel	6.560
1010500880909060100	Leather Primo 88, Black	Piping as upholstery	Brushed stainless steel	7.935
1010508410909060100	Leather Cera 905, Russet brown	Piping as upholstery	Brushed stainless steel	8.585

Essential variants only delivered with HR foam

Order configuration

	Black	Brushed stainless steel
Fabric group 1	6.570	6.570
Fabric group 2	6.825	6.825
Fabric group 3	6.950	6.950
Fabric group 4	7.320	7.320
Fabric group 5	8.785	8.785
C.O.M. fabric	6.570	6.570
Leather group 2	8.490	8.490
Leather group 3	9.190	9.190
Leather group 4	9.540	9.540
Leather group 5	10.970	10.970
C.O.M. leather	8.040	8.040

Fabric consumption: 3,8 m. Leather consumption: 9,5 m²

Not available in Trace leather.

Extra charge for

Leather piping for furniture with fabric:	+103
Arm pads in leather for furniture with fabric:	+53

Certifications

EN 1022:2005, EN 16139:2013 (L2)

Recommended upholstery

Fabric group 1	Linara, Bardal, Capture, Re-wool, Erik
Fabric group 2	Hallingdal, Barnum, Steelcut Trio, Fiord, Ruskin
Fabric group 3	Vidar, Clay, Sunniva, Divina Melange, Foss
Leather group 2	Primo
Leather group 3	Max
Leather group 4	Nubuck, Vegeta, Organic, Cera

Model P1010

Wegner Queen Accessories Neck cushion

Modeldetails



Designed by Hans J. Wegner, 1960

Removable neck cushion for Wegner Queen Chair. Available in leather only.

Order configuration

Leather group 2	405
Leather group 3	455
Leather group 4	485
Leather group 5	555
C.O.M. leather	370

Leather consumption: 0,5 m²

Recommended upholstery

Leather group 2	Primo
Leather group 3	Max
Leather group 4	Nubuck, Vegeta, Organic, Cera

Sofas

Model 5622

Calmo Sofa 2 seater, 80 cm cushions



Designed by Hugo Passos, 2019

Sofa with separate seat and back cushions. Inner frame of wood with nozag springs. Available in fabric or leather. Cushions available in foam core with down wrap or solid foam (CMHR or HR). External cover is non-removable. Cushion covers are removable. Leg trestles in solid wood or steel. Mounted with plastic glides. Felt glides available.

Modeldetails

1,06 m³ Packaging dimensions:
71 kg / 58 kg L: 174 cm W: 94 cm H: 65 cm

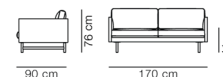

Essential Assortment

Item number	Upholstery	Frame	Price
5622028019311040046	Re-Wool 128	Black	3.975
5622028019311085446	Re-Wool 128	Oak lacquer, FSC Mix 70%	3.975
5622028007739040046	Sunniva 717	Black	4.220
5622028007739085446	Sunniva 717	Oak lacquer, FSC Mix 70%	4.220

Essential variants are delivered with plastic glides and HR foam core with down wrap

Order configuration

	Oak lacquered	Smoked oak stained, lacquered	Metal black	Matt chrome
Fabric group 1	4.100	4.100	4.100	4.100
Fabric group 2	4.395	4.395	4.395	4.395
Fabric group 3	4.960	4.960	4.960	4.960
Fabric group 4	5.810	5.810	5.810	5.810
Fabric group 5	6.910	6.910	6.910	6.910
C.O.M. fabric	4.100	4.100	4.100	4.100
Leather group 1	5.255	5.255	5.255	5.255
Leather group 2	6.615	6.615	6.615	6.615
Leather group 3	7.880	7.880	7.880	7.880
Leather group 4	8.665	8.665	8.665	8.665
Leather group 5	9.965	9.965	9.965	9.965
C.O.M. leather	5.255	5.255	5.255	5.255

Fabric consumption: 7,43 m. Leather consumption: 16,5 m²

Note - Complementary cushions are ordered separately (P5522).

Certifications

FSC® certified

EN 1022:2005, EN 16139:2013 (L2)

Recommended upholstery

Fabric group 1	Grand Linen, Remix, Capture, Bardal, Re-wool, Linara, Natural Linen, Erik
Fabric group 2	Hallingdal, Barnum, Loop, Steelcut Trio, Fiord, Ruskin, Savoy
Fabric group 3	Divina Melange, Vidar, Sunniva, Harald, Foss, Clay
Fabric group 4	Cotil, Elle, Sisu, Safire
Fabric group 5	Gentle
Leather group 1	Omni
Leather group 2	Primo, Trace
Leather group 3	Max
Leather group 4	Nubuck, Organic, Vegeta, Cera

Model 5652

Calmo Sofa 2 seater, 95 cm cushions



Designed by Hugo Passos, 2019

Sofa with separate seat and back cushions. Inner frame of wood with nozag springs. Available in fabric or leather. Cushions available in foam core with down wrap or solid foam (CMHR or HR). External cover is non-removable. Cushion covers are removable. Leg trestles in solid wood or steel. Mounted with plastic glides. Felt glides available.

Modeldetails

1,2 m³ Packaging dimensions:
83 kg / 64 kg L: 202 cm W: 93 cm H: 64 cm

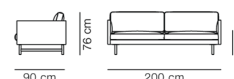

Essential Assortment

Item number	Upholstery	Frame	Price
5652029519311040046	Re-Wool 128	Black	3.975
5652029519311085446	Re-Wool 128	Oak lacquer, FSC Mix 70%	3.975
5652029507722040046	Sunniva 242	Black	4.220
5652029507722085446	Sunniva 242	Oak lacquer, FSC Mix 70%	4.220
5652029507739040046	Sunniva 717	Black	4.220
5652029507739085446	Sunniva 717	Oak lacquer, FSC Mix 70%	4.220
5652029507878040046	Sunniva 783	Black	4.220
5652029507878085446	Sunniva 783	Oak lacquer, FSC Mix 70%	4.220

Essential variants are delivered with plastic glides and HR foam core with down wrap

Order configuration

	Oak lacquered	Smoked oak stained, lacquered	Metal black	Matt chrome
Fabric group 1	4.310	4.310	4.310	4.310
Fabric group 2	4.815	4.815	4.815	4.815
Fabric group 3	5.405	5.405	5.405	5.405
Fabric group 4	6.405	6.405	6.405	6.405
Fabric group 5	7.700	7.700	7.700	7.700
C.O.M. fabric	4.310	4.310	4.310	4.310
Leather group 1	5.750	5.750	5.750	5.750
Leather group 2	7.350	7.350	7.350	7.350
Leather group 3	8.840	8.840	8.840	8.840
Leather group 4	9.725	9.725	9.725	9.725
Leather group 5	11.180	11.180	11.180	11.180
C.O.M. leather	5.750	5.750	5.750	5.750

Fabric consumption: 8,32 m. Leather consumption: 20 m²

Note - Complementary cushions are ordered separately (P5522).

Certifications

FSC® certified

EN 1022:2005, EN 16139:2013 (L2)



Recommended upholstery

Fabric group 1	Grand Linen, Remix, Capture, Bardal, Re-wool, Linara, Natural Linen, Erik
Fabric group 2	Hallingdal, Barnum, Loop, Steelcut Trio, Fiord, Ruskin, Savoy
Fabric group 3	Divina Melange, Vidar, Sunniva, Harald, Foss, Clay
Fabric group 4	Cotil, Elle, Sisu, Safire
Fabric group 5	Gentle
Leather group 1	Omni
Leather group 2	Primo, Trace
Leather group 3	Max
Leather group 4	Nubuck, Organic, Vegeta, Cera

Model 5623

Calmo Sofa 3 seater, 80 cm cushions

Modeldetails

 1,5 m³ Packaging dimensions:
 98 kg / 77 kg L: 252 cm W: 93 cm H: 64 cm



Designed by Hugo Passos, 2019

Sofa with separate seat and back cushions. Inner frame of wood with nozag springs. Available in fabric or leather. Cushions available in foam core with down wrap or solid foam (CMHR or HR). External cover is non-removable. Cushion covers are removable. Leg trestles in solid wood or steel. Mounted with plastic glides. Felt glides available.

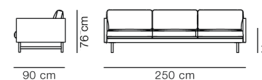

Essential Assortment

Item number	Upholstery	Frame	Price
5623038019311040046	Re-Wool 128	Black	4.820
5623038019311085446	Re-Wool 128	Oak lacquer, FSC Mix 70%	4.820
5623038007722040046	Sunniva 242	Black	5.305
5623038007722085446	Sunniva 242	Oak lacquer, FSC Mix 70%	5.305
5623038007739040046	Sunniva 717	Black	5.305
5623038007739085446	Sunniva 717	Oak lacquer, FSC Mix 70%	5.305
5623038007878040046	Sunniva 783	Black	5.305
5623038007878085446	Sunniva 783	Oak lacquer, FSC Mix 70%	5.305

Essential variants are delivered with plastic glides and HR foam core with down wrap

Order configuration

	Oak lacquered	Smoked oak stained, lacquered	Metal black	Matt chrome
Fabric group 1	5.175	5.175	5.175	5.175
Fabric group 2	5.460	5.460	5.460	5.460
Fabric group 3	6.185	6.185	6.185	6.185
Fabric group 4	7.275	7.275	7.275	7.275
Fabric group 5	8.675	8.675	8.675	8.675
C.O.M. fabric	5.175	5.175	5.175	5.175
Leather group 1	6.560	6.560	6.560	6.560
Leather group 2	8.295	8.295	8.295	8.295
Leather group 3	9.910	9.910	9.910	9.910
Leather group 4	10.900	10.900	10.900	10.900
Leather group 5	12.535	12.535	12.535	12.535
C.O.M. leather	6.560	6.560	6.560	6.560

Fabric consumption: 10,2 m. Leather consumption: 29,5 m²

Note - Complementary cushions are ordered separately (P5522).

Certifications

FSC® certified

EN 1022:2005, EN 16139:2013 (L2)

Recommended upholstery



Fabric group 1	Grand Linen, Remix, Capture, Bardal, Re-wool, Linara, Natural Linen, Erik
Fabric group 2	Hallingdal, Barnum, Loop, Steelcut Trio, Fiord, Ruskin, Savoy
Fabric group 3	Divina Melange, Vidar, Sunniva, Harald, Foss, Clay
Fabric group 4	Cotil, Elle, Sisu, Safire
Fabric group 5	Gentle
Leather group 1	Omni
Leather group 2	Primo, Trace
Leather group 3	Max
Leather group 4	Nubuck, Organic, Vegeta, Cera

Model 5625

Calmo Chaise Sofa

80 cm cushions, Chaise L or R

Modeldetails

 2,1 m³ Packaging dimensions:
 118 kg / 93 kg L: 252/96 cm W: 93/68 cm H: 64/45 cm



Designed by Hugo Passos, 2019

Sofa with separate seat and back cushions. Inner frame of wood with nozag springs. Available in fabric or leather. Cushions available in foam core with down wrap or solid foam (CMHR or HR). External cover is non-removable. Cushion covers are removable. Leg trestles in solid wood or steel. The placement of the chaise lounge can be changed on the spot using a standard hex key. Mounted with plastic glides. Felt glides available.

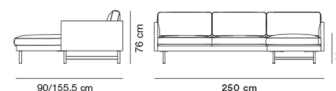

Order configuration

	Oak lacquered	Smoked oak stained, lacquered	Metal black	Matt chrome
Fabric group 1	6.155	6.155	6.155	6.155
Fabric group 2	6.740	6.740	6.740	6.740
Fabric group 3	7.475	7.475	7.475	7.475
Fabric group 4	8.800	8.800	8.800	8.800
Fabric group 5	10.510	10.510	10.510	10.510
C.O.M. fabric	6.155	6.155	6.155	6.155
Leather group 1	7.930	7.930	7.930	7.930
Leather group 2	10.050	10.050	10.050	10.050
Leather group 3	12.020	12.020	12.020	12.020
Leather group 4	13.220	13.220	13.220	13.220
Leather group 5	15.205	15.205	15.205	15.205
C.O.M. leather	7.930	7.930	7.930	7.930

Fabric consumption: 11,3 m. Leather consumption: 40,5 m²

Note - Complementary cushions are ordered separately (P5522).

Certifications

FSC® certified

EN 1022:2005, EN 16139:2013 (L2)

Recommended upholstery

Fabric group 1	Grand Linen, Remix, Capture, Bardal, Re-wool, Linara, Natural Linen, Erik
Fabric group 2	Hallingdal, Barnum, Loop, Steelcut Trio, Fiord, Ruskin, Savoy
Fabric group 3	Divina Melange, Vidar, Sunniva, Harald, Foss, Clay
Fabric group 4	Cotil, Elle, Sisu, Safire
Fabric group 5	Gentle
Leather group 1	Omni
Leather group 2	Primo, Trace
Leather group 3	Max
Leather group 4	Nubuck, Organic, Vegeta, Cera

Model 5620

Calmo Ottoman 80 cm cushion



Designed by Hugo Passos, 2019

Ottoman with separate seat cushion. Inner frame of wood with nozag springs. Available in fabric or leather. Cushions available in foam core with down wrap or solid foam (CMHR or HR). External cover is non-removable. Cushion cover are removable. Leg trestles in solid wood or steel. Mounted with plastic glides. Felt glides available.

Modeldetails

0,29 m³ Packaging dimensions:
23 kg / 15,5 kg L: 68 cm W: 96 cm H: 45 cm



Order configuration

	Oak lacquered	Smoked oak stained, lacquered	Metal black	Matt chrome
Fabric group 1	1.905	1.905	1.905	1.905
Fabric group 2	2.050	2.050	2.050	2.050
Fabric group 3	2.175	2.175	2.175	2.175
Fabric group 4	2.410	2.410	2.410	2.410
Fabric group 5	2.710	2.710	2.710	2.710
C.O.M. fabric	1.905	1.905	1.905	1.905
Leather group 1	2.255	2.255	2.255	2.255
Leather group 2	2.630	2.630	2.630	2.630
Leather group 3	2.975	2.975	2.975	2.975
Leather group 4	3.275	3.275	3.275	3.275
Leather group 5	3.765	3.765	3.765	3.765
C.O.M. leather	2.255	2.255	2.255	2.255

Fabric consumption: 1,74 m. Leather consumption: 4 m²

Certifications

EN 1022:2005, EN 16139:2013 (L2)

Recommended upholstery

Fabric group 1	Grand Linen, Remix, Capture, Bardal, Re-wool, Linara, Natural Linen, Erik
Fabric group 2	Hallingdal, Barnum, Loop, Steelcut Trio, Fiord, Ruskin, Savoy
Fabric group 3	Divina Melange, Vidar, Sunniva, Harald, Foss, Clay
Fabric group 4	Cotil, Elle, Sisu, Safire
Fabric group 5	Gentle
Leather group 1	Omni
Leather group 2	Primo, Trace
Leather group 3	Max
Leather group 4	Nubuck, Organic, Vegeta, Cera

Model P5522

Calmo Accessories Set of 3 decorative cushions



Designed by Hugo Passos

Decorative cushion for Calmo. Down filling. Removable cover in fabric. Available in fabric or leather.

Modeldetails

3,5 kg /
3 kg

Packaging dimensions:

L: 41 cm W: 41 cm H: 10 cm

Essential Assortment

Item number	Upholstery	Price
P552219311019	Re-Wool 128	275
P552207722019	Sunniva 242	335
P552207739019	Sunniva 717	335
P552207878019	Sunniva 783	335

Order configuration

Fabric group 1	295
Fabric group 2	370
Fabric group 3	435
Fabric group 4	550
Fabric group 5	695
C.O.M. fabric	295
Leather group 1	475
Leather group 2	655
Leather group 3	820
Leather group 4	905
Leather group 5	1.040
C.O.M. leather	475

Fabric consumption: 1,36 m. Leather consumption: 1,5 m²

Cushion: 40 x 40 cm.

Recommended upholstery

Fabric group 1	Grand Linen, Linara, Bardal, Capture, Remix, Natural Linen, Re-wool, Erik
Fabric group 2	Hallingdal, Savoy, Barnum, Steelcut Trio, Fiord, Ruskin, Loop
Fabric group 3	Harald, Vidar, Clay, Sunniva, Divina Melange, Foss
Fabric group 4	Sisu, Elle, Safire, Cotil
Fabric group 5	Gentle

Model 562A

Calmo Elements Configuration A, 333 x 253cm

Modeldetails

- 3,1 m³
- 200 kg /
163 kg



Designed by Hugo Passos, 2022

Sofa with separate seat and back cushions. Inner frame of wood with nozag springs. Available in fabric. Cushions available in foam core with down wrap or solid foam (CMHR or HR). External cover is non-removable. Cushion covers are removable. Leg trestles in solid wood or steel. Mounted with plastic glides. Felt glides available.



Order configuration

Leg trestles: Oak lacquered, Smoked oak stained lacquered, Metal black or Matt chrome

Fabric group 1	10.770
Fabric group 2	11.555
Fabric group 3	13.055
Fabric group 4	15.385
Fabric group 5	18.330
C.O.M. fabric	10.770

Fabric consumption: 19,22 m

Note - Complementary cushions are ordered separately (P5522).

Certifications

FSC® certified

EN 1022:2005, EN 16139:2013 (L2)

Recommended upholstery

Fabric group 1	Grand Linen, Linara, Bardal, Capture, Remix, Natural Linen, Re-wool, Erik
Fabric group 2	Hallingdal, Savoy, Barnum, Steelcut Trio, Fiord, Ruskin, Loop
Fabric group 3	Harald, Vidar, Clay, Sunniva, Divina Melange, Foss
Fabric group 4	Sisu, Elle, Safire, Cotil
Fabric group 5	Gentle

Model 562B

Calmo Elements Configuration B, 333 x 253cm

Modeldetails

- 3,1 m³
- 200 kg /
163 kg



Designed by Hugo Passos, 2022

Sofa with separate seat and back cushions. Inner frame of wood with nozag springs. Available in fabric. Cushions available in foam core with down wrap or solid foam (CMHR or HR). External cover is non-removable. Cushion covers are removable. Leg trestles in solid wood or steel. Mounted with plastic glides. Felt glides available.



Order configuration

Leg trestles: Oak lacquered, Smoked oak stained lacquered, Metal black or Matt chrome

Fabric group 1	10.770
Fabric group 2	11.555
Fabric group 3	13.055
Fabric group 4	15.385
Fabric group 5	18.330
C.O.M. fabric	10.770

Fabric consumption: 19,22 m

Note - Complementary cushions are ordered separately (P5522).

Certifications

FSC® certified

EN 1022:2005, EN 16139:2013 (L2)

Recommended upholstery

Fabric group 1	Grand Linen, Linara, Bardal, Capture, Remix, Natural Linen, Re-wool, Erik
Fabric group 2	Hallingdal, Savoy, Barnum, Steelcut Trio, Fiord, Ruskin, Loop
Fabric group 3	Harald, Vidar, Clay, Sunniva, Divina Melange, Foss
Fabric group 4	Sisu, Elle, Safire, Cotil
Fabric group 5	Gentle

Model 562C

Calmo Elements Configuration C, 333 x 333cm

Modeldetails

3,54 m³
227 kg /
182 kg



Designed by Hugo Passos, 2022

Sofa with separate seat and back cushions. Inner frame of wood with nozag springs. Available in fabric. Cushions available in foam core with down wrap or solid foam (CMHR or HR). External cover is non-removable. Cushion covers are removable. Leg trestles in solid wood or steel. Mounted with plastic glides. Felt glides available.



Order configuration

Leg trestles: Oak lacquered, Smoked oak stained lacquered, Metal black or Matt chrome

Fabric group 1	11.845
Fabric group 2	12.620
Fabric group 3	14.280
Fabric group 4	16.850
Fabric group 5	20.095
C.O.M. fabric	11.845

Fabric consumption: 21,9 m

Note - Complementary cushions are ordered separately (P5522).

Certifications

FSC® certified

EN 1022:2005, EN 16139:2013 (L2)

Recommended upholstery

Fabric group 1	Grand Linen, Linara, Bardal, Capture, Remix, Natural Linen, Re-wool, Erik
Fabric group 2	Hallingdal, Savoy, Barnum, Steelcut Trio, Fiord, Ruskin, Loop
Fabric group 3	Harald, Vidar, Clay, Sunniva, Divina Melange, Foss
Fabric group 4	Sisu, Elle, Safire, Cotil
Fabric group 5	Gentle

Model 562D

Calmo Elements Configuration D, 253 x 253cm

Modeldetails

2,66 m³
173 kg /
144 kg



Designed by Hugo Passos, 2022

Sofa with separate seat and back cushions. Inner frame of wood with nozag springs. Available in fabric. Cushions available in foam core with down wrap or solid foam (CMHR or HR). External cover is non-removable. Cushion covers are removable. Leg trestles in solid wood or steel. Mounted with plastic glides. Felt glides available.



Order configuration

Leg trestles: Oak lacquered, Smoked oak stained lacquered, Metal black or Matt chrome

Fabric group 1	9.695
Fabric group 2	10.490
Fabric group 3	11.830
Fabric group 4	13.920
Fabric group 5	16.565
C.O.M. fabric	9.695

Fabric consumption: 16,54 m

Note - Complementary cushions are ordered separately (P5522).

Certifications

FSC® certified

EN 1022:2005, EN 16139:2013 (L2)

Recommended upholstery

Fabric group 1	Grand Linen, Linara, Bardal, Capture, Remix, Natural Linen, Re-wool, Erik
Fabric group 2	Hallingdal, Savoy, Barnum, Steelcut Trio, Fiord, Ruskin, Loop
Fabric group 3	Harald, Vidar, Clay, Sunniva, Divina Melange, Foss
Fabric group 4	Sisu, Elle, Safire, Cotil
Fabric group 5	Gentle

Model 562E

Calmo Elements Configuration E, 253 x 174cm

Modeldetails

2,14 m³

149 kg /
130 kg



Designed by Hugo Passos, 2022

Sofa with separate seat and back cushions. Inner frame of wood with nozag springs. Available in fabric. Cushions available in foam core with down wrap or solid foam (CMHR or HR). External cover is non-removable. Cushion covers are removable. Leg trestles in solid wood or steel. Mounted with plastic glides. Felt glides available.



Order configuration

Leg trestles: Oak lacquered, Smoked oak stained lacquered, Metal black or Matt chrome

Fabric group 1	8.525
Fabric group 2	9.315
Fabric group 3	10.360
Fabric group 4	12.140
Fabric group 5	14.385
C.O.M. fabric	8.525

Fabric consumption: 13,94 m

Note - Complementary cushions are ordered separately (P5522).

Certifications

FSC® certified

EN 1022:2005, EN 16139:2013 (L2)

Recommended upholstery

Fabric group 1	Grand Linen, Linara, Bardal, Capture, Remix, Natural Linen, Re-wool, Erik
Fabric group 2	Hallingdal, Savoy, Barnum, Steelcut Trio, Fiord, Ruskin, Loop
Fabric group 3	Harald, Vidar, Clay, Sunniva, Divina Melange, Foss
Fabric group 4	Sisu, Elle, Safire, Cotil
Fabric group 5	Gentle

Model 562F

Calmo Elements Configuration F, 253 x 174cm

Modeldetails

2,14 m³
149 kg /
130 kg



Designed by Hugo Passos, 2022

Sofa with separate seat and back cushions. Inner frame of wood with nozag springs. Available in fabric. Cushions available in foam core with down wrap or solid foam (CMHR or HR). External cover is non-removable. Cushion covers are removable. Leg trestles in solid wood or steel. Mounted with plastic glides. Felt glides available.



Order configuration

Leg trestles: Oak lacquered, Smoked oak stained lacquered, Metal black or Matt chrome

Fabric group 1	8.525
Fabric group 2	9.315
Fabric group 3	10.360
Fabric group 4	12.140
Fabric group 5	14.385
C.O.M. fabric	8.525

Fabric consumption: 13,94 m

Note - Complementary cushions are ordered separately (P5522).

Certifications

FSC® certified

EN 1022:2005, EN 16139:2013 (L2)

Recommended upholstery

Fabric group 1	Grand Linen, Linara, Bardal, Capture, Remix, Natural Linen, Re-wool, Erik
Fabric group 2	Hallingdal, Savoy, Barnum, Steelcut Trio, Fiord, Ruskin, Loop
Fabric group 3	Harald, Vidar, Clay, Sunniva, Divina Melange, Foss
Fabric group 4	Sisu, Elle, Safire, Cotil
Fabric group 5	Gentle

Model 562G

Calmo Elements Configuration G, 417 x 333cm

Modeldetails

5,14 m³

329 kg /
268 kg



Designed by Hugo Passos, 2022

Sofa with separate seat and back cushions. Inner frame of wood with nozag springs. Available in fabric. Cushions available in foam core with down wrap or solid foam (CMHR or HR). External cover is non-removable. Cushion covers are removable. Leg trestles in solid wood or steel. Mounted with plastic glides. Felt glides available.



Order configuration

Leg trestles: Oak lacquered, Smoked oak stained lacquered, Metal black or Matt chrome

Fabric group 1	17.440
Fabric group 2	18.715
Fabric group 3	21.150
Fabric group 4	24.960
Fabric group 5	29.750
C.O.M. fabric	17.440

Fabric consumption: 31,53 m

Note - Complementary cushions are ordered separately (P5522).

Certifications

FSC® certified

EN 1022:2005, EN 16139:2013 (L2)

Recommended upholstery

Fabric group 1	Grand Linen, Linara, Bardal, Capture, Remix, Natural Linen, Re-wool, Erik
Fabric group 2	Hallingdal, Savoy, Barnum, Steelcut Trio, Fiord, Ruskin, Loop
Fabric group 3	Harald, Vidar, Clay, Sunniva, Divina Melange, Foss
Fabric group 4	Sisu, Elle, Safire, Cotil
Fabric group 5	Gentle

Model 562H

Calmo Elements Configuration H, 417 x 333cm

Modeldetails

5,14 m³

329 kg /
268 kg



Designed by Hugo Passos, 2022

Sofa with separate seat and back cushions. Inner frame of wood with nozag springs. Available in fabric. Cushions available in foam core with down wrap or solid foam (CMHR or HR). External cover is non-removable. Cushion covers are removable. Leg trestles in solid wood or steel. Mounted with plastic glides. Felt glides available.



Order configuration

Leg trestles: Oak lacquered, Smoked oak stained lacquered, Metal black or Matt chrome

Fabric group 1	17.440
Fabric group 2	18.715
Fabric group 3	21.150
Fabric group 4	24.960
Fabric group 5	29.750
C.O.M. fabric	17.440

Fabric consumption: 31,53 m

Note - Complementary cushions are ordered separately (P5522).

Certifications

FSC® certified

EN 1022:2005, EN 16139:2013 (L2)

Recommended upholstery

Fabric group 1	Grand Linen, Linara, Bardal, Capture, Remix, Natural Linen, Re-wool, Erik
Fabric group 2	Hallingdal, Savoy, Barnum, Steelcut Trio, Fiord, Ruskin, Loop
Fabric group 3	Harald, Vidar, Clay, Sunniva, Divina Melange, Foss
Fabric group 4	Sisu, Elle, Safire, Cotil
Fabric group 5	Gentle

Calmo Elements - Overview

Model 562A, Configuration A

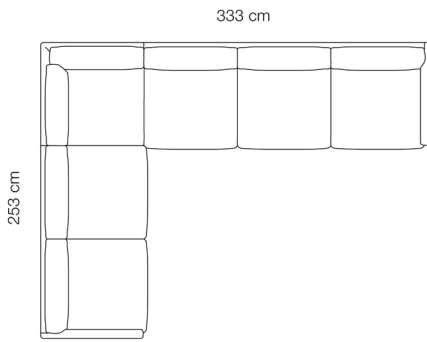

Model 562B, Configuration B

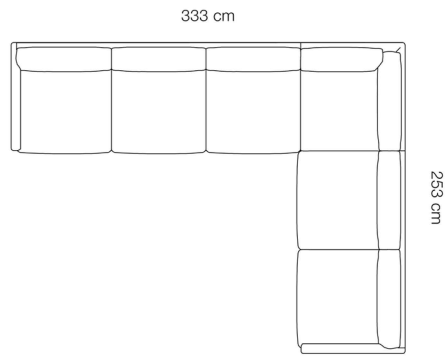

Model 562C, Configuration C

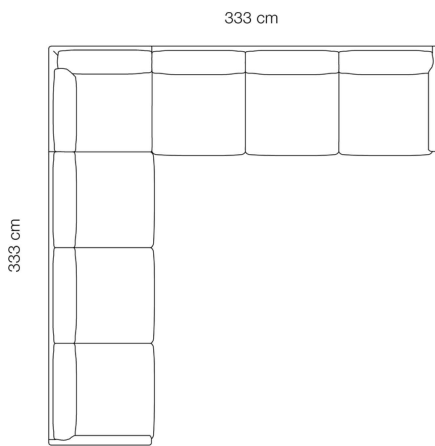

Model 562D, Configuration D

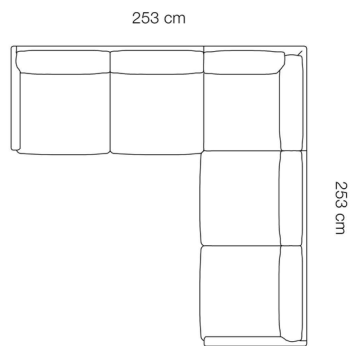

Model 562E, Configuration E

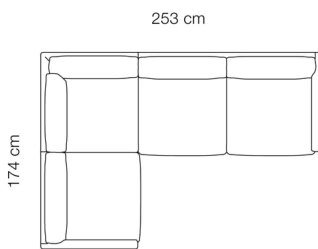

Model 562F, Configuration F

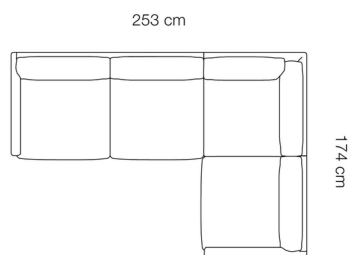

Model 562G, Configuration G

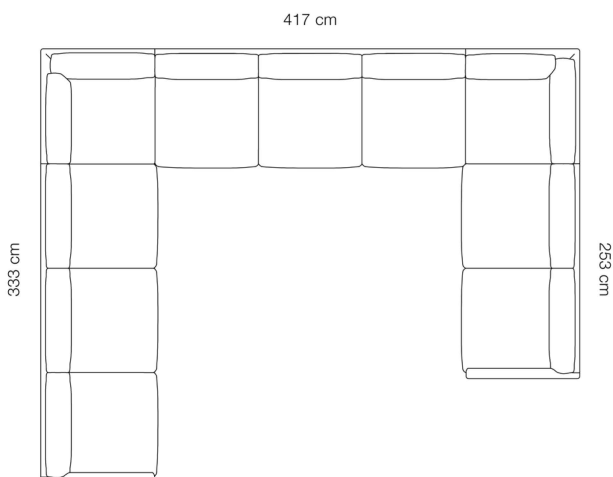

Model 562H, Configuration H

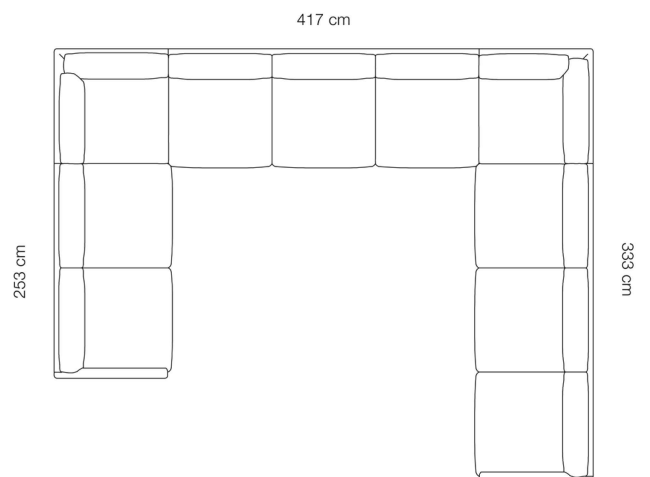

Model 4510

Delphi Sofa 205x85 cm



Designed by Hannes Wettstein, 2007

Fully upholstered sofa. Inner frame of wood with nozag springs, cold cured foam and duvet of down and foam granulate mixture. Available in fabric or leather. Aluminum or solid wood base.

Modeldetails

1,3 m³ Packaging dimensions:
100 kg / 90 kg L: 210 cm W: 95 cm H: 64 cm

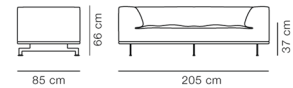

Essential Assortment

Item number	Upholstery	Legs	Price
45100401009098510100	Steelcut Trio, 213	Brushed aluminium	4.725
45105009809098510100	Leather Max 98, Black	Brushed aluminium	8.275
45105084109098510100	Leather Cera 905, Russet brown	Brushed aluminium	10.050

Essential variants only delivered with HR foam

Order configuration

Plinth: Oak light oil or same as other upholstery or leather (98 black, 95 cognac, 90 natural).

	Brushed aluminium	Oak light oil	Black
Fabric group 1	4.820	4.820	4.820
Fabric group 2	5.115	5.115	5.115
Fabric group 3	5.395	5.395	5.395
Fabric group 4	5.820	5.820	5.820
Fabric group 5	6.840	6.840	6.840
C.O.M. fabric	4.820	4.820	4.820
Leather group 1	6.830	6.830	6.830
Leather group 2	7.555	7.555	7.555
Leather group 3	8.715	8.715	8.715
Leather group 4	10.290	10.290	10.290
Leather group 5	12.730	12.730	12.730
C.O.M. leather	6.830	6.830	6.830

Fabric consumption: 5,8 m. Leather consumption: 16,5 m²

Leather consumption plinth: 2,25 m²

Extra charge for

Leather plinth if upholstery is in fabric: +832
Extra sitting height (2,5 cm): +206

Certifications

EN 1022:2005, EN 16139:2013 (L2)

Recommended upholstery

Fabric group 1	Grand Linen, Remix, Capture, Bardal, Re-wool, Linara, Natural Linen, Erik
Fabric group 2	Hallingdal, Barnum, Loop, Steelcut Trio, Fiord, Ruskin
Fabric group 3	Divina Melange, Vidar, Foss, Clay
Fabric group 4	Elle, Sisu, Safire
Fabric group 5	Gentle
Leather group 1	Omni
Leather group 2	Primo, Trace
Leather group 3	Max
Leather group 4	Nubuck, Vegeta, Organic, Cera

Model 4511

Delphi Sofa 240x85 cm



Designed by Hannes Wettstein, 2007

Fully upholstered sofa. Inner frame of wood with nozag springs, cold cured foam and duvet of down and foam granulate mixture. Available in fabric or leather. Aluminum or solid wood base.

Modeldetails

1,5 m³ Packaging dimensions:
110 kg / L: 245 cm W: 95 cm H: 64 cm
100 kg

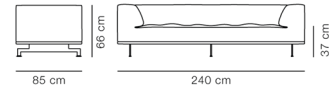

Essential Assortment

Item number	Upholstery	Legs	Price
45110401009098510100	Steelcut Trio, 213	Brushed aluminium	5.320
45115009809098510100	Leather Max 98, Black	Brushed aluminium	9.455
45115084109098510100	Leather Cera 905, Russet brown	Brushed aluminium	11.230

Essential variants only delivered with HR foam

Order configuration

Plinth: Oak light oil or same as other upholstery or leather (98 black, 95 cognac, 90 natural).

	Brushed aluminium	Oak light oil	Black
Fabric group 1	5.225	5.225	5.225
Fabric group 2	5.555	5.555	5.555
Fabric group 3	5.870	5.870	5.870
Fabric group 4	6.345	6.345	6.345
Fabric group 5	7.490	7.490	7.490
C.O.M. fabric	5.225	5.225	5.225
Leather group 1	7.720	7.720	7.720
Leather group 2	8.595	8.595	8.595
Leather group 3	10.000	10.000	10.000
Leather group 4	11.615	11.615	11.615
Leather group 5	15.230	15.230	15.230
C.O.M. leather	7.720	7.720	7.720

Fabric consumption: 6,5 m. Leather consumption: 20 m²

Leather consumption plinth: 2,25 m²

Extra charge for

Leather plinth if upholstery is in fabric: +832
Extra sitting height (2,5 cm): +206

Certifications

EN 1022:2005, EN 16139:2013 (L2)

Recommended upholstery

Fabric group 1 Grand Linen, Remix, Capture, Bardal, Re-wool, Linara, Natural Linen, Erik
Fabric group 2 Hallingdal, Barnum, Loop, Steelcut Trio, Fiord, Ruskin
Fabric group 3 Divina Melange, Vidar, Foss, Clay
Fabric group 4 Elle, Sisu, Safire
Fabric group 5 Gentle
Leather group 1 Omni
Leather group 2 Primo, Trace
Leather group 3 Max
Leather group 4 Nubuck, Vegeta, Organic, Cera

Model 4512

Delphi Sofa 325x85 cm

Modeldetails

2,7 m³ Packaging dimensions:
185 kg / L: 335 cm W: 95 cm H: 85 cm
120 kg



Designed by Hannes Wettstein, 2007

Fully upholstered sofa. Inner frame of wood with nozag springs, cold cured foam and duvet of down and foam granulate mixture. Available in fabric or leather. Aluminum or solid wood base.

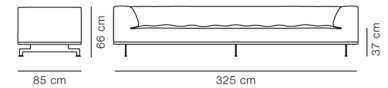

Essential Assortment

Item number	Upholstery	Legs	Price
45120401009098510100	Steelcut Trio, 213	Brushed aluminium	7.090
45125009809098510100	Leather Max 98, Black	Brushed aluminium	15.725
45125084109098510100	Leather Cera 905, Russet brown	Brushed aluminium	16.905

Essential variants only delivered with HR foam

Order configuration

Plinth: Oak light oil or same as other upholstery or leather (98 black, 95 cognac, 90 natural).

	Brushed aluminium	Oak light oil	Black
Fabric group 1	7.790	7.790	7.790
Fabric group 2	8.460	8.460	8.460
Fabric group 3	8.780	8.780	8.780
Fabric group 4	9.745	9.745	9.745
Fabric group 5	11.695	11.695	11.695
C.O.M. fabric	7.790	7.790	7.790
Leather group 1	12.850	12.850	12.850
Leather group 2	14.325	14.325	14.325
Leather group 3	16.615	16.615	16.615
Leather group 4	17.750	17.750	17.750
Leather group 5	20.415	20.415	20.415
C.O.M. leather	12.850	12.850	12.850

Fabric consumption: 8,5 m. Leather consumption: 22 m²

Leather consumption plinth: 2,25 m²

Extra charge for

Leather plinth if upholstery is in fabric:	+832
Extra sitting height (2,5 cm):	+206

Certifications

EN 1022:2005, EN 16139:2013 (L2)

Recommended upholstery

Fabric group 1	Grand Linen, Remix, Capture, Bardal, Re-wool, Linara, Natural Linen, Erik
Fabric group 2	Hallingdal, Barnum, Loop, Steelcut Trio, Fiord, Ruskin
Fabric group 3	Divina Melange, Vidar, Foss, Clay
Fabric group 4	Elle, Sisu, Safire
Fabric group 5	Gentle
Leather group 1	Omni
Leather group 2	Primo, Trace
Leather group 3	Max
Leather group 4	Nubuck, Vegeta, Organic, Cera

Model 4513

Delphi Elements Corner module 85x85 cm



Designed by Hannes Wettstein, 2007

Square corner module for Delphi modular sofa system. Fully upholstered in fabric or leather. Inner frame of wood with nozag springs, cold cured foam and duvet of down and foam granulate mixture. Aluminum or solid wood base. Modules can be independently rearranged.

Modeldetails

0,6 m³ Packaging dimensions:
50 kg / 45 kg L: 95 cm W: 64 cm H: 100 cm

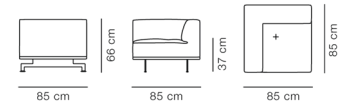

Order configuration

Plinth: Oak light oil or same as other upholstery or leather (98 black, 95 cognac, 90 natural).

	Brushed aluminium	Oak light oil	Black
Fabric group 1	2.680	2.680	2.680
Fabric group 2	2.905	2.905	2.905
Fabric group 3	3.015	3.015	3.015
Fabric group 4	3.335	3.335	3.335
Fabric group 5	4.005	4.005	4.005
C.O.M. fabric	2.680	2.680	2.680
Leather group 1	4.220	4.220	4.220
Leather group 2	4.700	4.700	4.700
Leather group 3	5.440	5.440	5.440
Leather group 4	5.810	5.810	5.810
Leather group 5	6.680	6.680	6.680
C.O.M. leather	4.220	4.220	4.220

Fabric consumption: 3,5 m. Leather consumption: 7,5 m²

Leather consumption plinth: 2,25 m²

Extra charge for

Leather plinth if upholstery is in fabric: +416
Extra sitting height (2,5 cm): +206

Certifications

EN 1022:2005, EN 16139:2013 (L2)

Recommended upholstery

Fabric group 1 Grand Linen, Remix, Capture, Bardal, Re-wool, Linara, Natural Linen, Erik
Fabric group 2 Hallingdal, Loop, Steelcut Trio, Fiord, Ruskin, Barnum
Fabric group 3 Divina Melange, Vidar, Foss, Clay
Fabric group 4 Elle, Sisu, Safire
Fabric group 5 Gentle
Leather group 1 Omni
Leather group 2 Primo, Trace
Leather group 3 Max
Leather group 4 Nubuck, Vegeta, Organic, Cera

Model 4501

Delphi Elements End module 120x85 cm, Arm L or R



Designed by Hannes Wettstein, 2007

Rectangular end module for Delphi modular sofa system. Fully upholstered in fabric or leather. Inner frame of wood with nozag springs, cold cured foam and duvet of down and foam granulate mixture. Aluminum or solid wood base. Modules can be independently rearranged. Please specify right- or left-hand corner.

Model details

0,8 m³ Packaging dimensions:
65 kg / 60 kg L: 125 cm W: 95 cm H: 64 cm

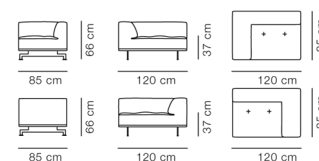

Essential Assortment

Item number	Upholstery	Legs	Module type	Price
45010401009027510100	Steelcut Trio, 213	Brushed aluminium	Right module	2.885
45010401009028510100	Steelcut Trio, 213	Brushed aluminium	Left module	2.885
45015009809027510100	Leather Max 98, Black	Brushed aluminium	Right module	5.035
45015009809028510100	Leather Max 98, Black	Brushed aluminium	Left module	5.035
45015084109027510100	Leather Cera 905, Russet brown	Brushed aluminium	Right module	5.900
45015084109028510100	Leather Cera 905, Russet brown	Brushed aluminium	Left module	5.900

Essential variants only delivered with HR foam

Order configuration

Plinth: Oak light oil or same as other upholstery or leather (98 black, 95 cognac, 90 natural).
Right or left hand arm.

	Brushed aluminium	Oak light oil	Black
Fabric group 1	2.765	2.765	2.765
Fabric group 2	2.990	2.990	2.990
Fabric group 3	3.200	3.200	3.200
Fabric group 4	3.515	3.515	3.515
Fabric group 5	4.280	4.280	4.280
C.O.M. fabric	2.765	2.765	2.765
Leather group 1	3.955	3.955	3.955
Leather group 2	4.410	4.410	4.410
Leather group 3	5.135	5.135	5.135
Leather group 4	6.125	6.125	6.125
Leather group 5	7.840	7.840	7.840
C.O.M. leather	3.955	3.955	3.955

Fabric consumption: 4,2 m. Leather consumption: 10 m²

Leather consumption plinth: 2,25 m²

Extra charge for

Leather plinth if upholstery is in fabric:	+416
Extra sitting height (2,5 cm):	+206

Certifications

EN 1022:2005, EN 16139:2013 (L2)

Recommended upholstery

Fabric group 1	Grand Linen, Remix, Capture, Bardal, Re-wool, Linara, Natural Linen, Erik
Fabric group 2	Hallingdal, Barnum, Loop, Steelcut Trio, Fiord, Ruskin
Fabric group 3	Divina Melange, Vidar, Foss, Clay
Fabric group 4	Elle, Sisu, Safire
Fabric group 5	Gentle
Leather group 1	Omni
Leather group 2	Primo, Trace
Leather group 3	Max
Leather group 4	Nubuck, Vegeta, Organic, Cera

Model 4514

Delphi Elements End module 180x85 cm, Arm L or R



Designed by Hannes Wettstein, 2007

Long rectangular end module for Delphi modular sofa system. Fully upholstered in fabric or leather. Inner frame of wood with nozag springs, cold cured foam and duvet of down and foam granulate mixture. Aluminum or solid wood base. Modules can be independently rearranged. Please specify right- or left-hand corner.

Modeldetails

1,1 m³ Packaging dimensions:
85 kg / 80 kg L: 185 cm W: 95 cm H: 64 cm

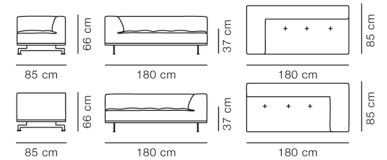

Order configuration

Plinth: Oak light oil or same as other upholstery or leather (98 black, 95 cognac, 90 natural).
Right or left hand arm.

	Brushed aluminium	Oak light oil	Black
Fabric group 1	3.625	3.625	3.625
Fabric group 2	3.960	3.960	3.960
Fabric group 3	4.120	4.120	4.120
Fabric group 4	4.610	4.610	4.610
Fabric group 5	5.530	5.530	5.530
C.O.M. fabric	3.625	3.625	3.625
Leather group 1	5.900	5.900	5.900
Leather group 2	6.610	6.610	6.610
Leather group 3	7.705	7.705	7.705
Leather group 4	8.250	8.250	8.250
Leather group 5	9.485	9.485	9.485
C.O.M. leather	5.900	5.900	5.900

Fabric consumption: 5,3 m. Leather consumption: 12,5 m²

Leather consumption plinth: 2,25 m²

Extra charge for

Leather plinth if upholstery is in fabric: +416
Extra sitting height (2,5 cm): +206

Certifications

EN 1022:2005, EN 16139:2013 (L2)

Recommended upholstery

Fabric group 1 Grand Linen, Remix, Capture, Bardal, Re-wool, Linara, Natural Linen, Erik
Fabric group 2 Hallingdal, Barnum, Loop, Steelcut Trio, Fiord, Ruskin
Fabric group 3 Divina Melange, Vidar, Foss, Clay
Fabric group 4 Elle, Sisu, Safire
Fabric group 5 Gentle
Leather group 1 Omni
Leather group 2 Primo, Trace
Leather group 3 Max
Leather group 4 Nubuck, Vegeta, Organic, Cera

Model 4504

Delphi Elements Ottoman 120x85 cm



Designed by Hannes Wettstein, 2007

Ottoman with inner frame of wood, cold cured foam and foam duvet. Fully upholstered in fabric or leather. Inner frame of wood with nozag springs, cold cured foam and duvet of down and foam granulate mixture. Aluminum or solid wood base. Can be used as part of modular configuration. Modules can be independently rearranged.

Modeldetails

0,6 m³ Packaging dimensions:
52 kg / 47 kg L: 125 cm W: 88 cm H: 52 cm

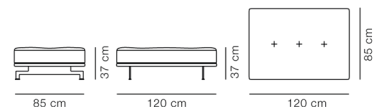

Essential Assortment

Item number	Upholstery	Legs	Price
45040401009098510100	Steelcut Trio, 213	Brushed aluminium	2.025
45045009809098510100	Leather Max 98, Black	Brushed aluminium	3.265
45045084109098510100	Leather Cera 905, Russet brown	Brushed aluminium	3.885

Essential variants only delivered with HR foam

Order configuration

Plinth: Oak light oil or same as other upholstery or leather (98 black, 95 cognac, 90 natural).

	Brushed aluminium	Oak light oil	Black
Fabric group 1	1.975	1.975	1.975
Fabric group 2	2.095	2.095	2.095
Fabric group 3	2.210	2.210	2.210
Fabric group 4	2.380	2.380	2.380
Fabric group 5	2.785	2.785	2.785
C.O.M. fabric	1.975	1.975	1.975
Leather group 1	2.665	2.665	2.665
Leather group 2	2.920	2.920	2.920
Leather group 3	3.330	3.330	3.330
Leather group 4	4.035	4.035	4.035
Leather group 5	5.145	5.145	5.145
C.O.M. leather	2.665	2.665	2.665

Fabric consumption: 2,6 m. Leather consumption: 6,5 m²

Leather consumption plinth: 2,25 m²

Extra charge for

Leather plinth if upholstery is in fabric:	+416
Extra sitting height (2,5 cm):	+206

Certifications

EN 1022:2005, EN 16139:2013 (L2)

Recommended upholstery

Fabric group 1	Grand Linen, Remix, Capture, Bardal, Re-wool, Linara, Natural Linen, Erik
Fabric group 2	Hallingdal, Barnum, Loop, Steelcut Trio, Fiord, Ruskin
Fabric group 3	Divina Melange, Vidar, Foss, Clay
Fabric group 4	Elle, Sisu, Safire
Fabric group 5	Gentle
Leather group 1	Omni
Leather group 2	Primo, Trace
Leather group 3	Max
Leather group 4	Nubuck, Vegeta, Organic, Cera

Model 4505

Delphi Elements Ottoman 85x85 cm



Designed by Hannes Wettstein, 2007

Ottoman with inner frame of wood, cold cured foam and foam duvet. Fully upholstered in fabric or leather. Inner frame of wood with nozag springs, cold cured foam and duvet of down and foam granulate mixture. Aluminum or solid wood base. Can be used as part of modular configuration. Modules can be independently rearranged.

Modeldetails

0,4 m³ Packaging dimensions:
30 kg / 25 kg L: 95 cm W: 85 cm H: 52 cm

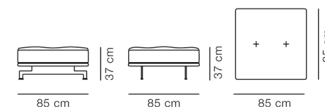

Essential Assortment

Item number	Upholstery	Legs	Price
45050401009098510100	Steelcut Trio, 213	Brushed aluminium	1.950
45055009809098510100	Leather Max 98, Black	Brushed aluminium	3.250
45055084109098510100	Leather Cera 905, Russet brown	Brushed aluminium	3.640

Essential variants only delivered with HR foam

Order configuration

Plinth: Oak light oil or same as other upholstery or leather (98 black, 95 cognac, 90 natural).

	Brushed aluminium	Oak light oil	Black
Fabric group 1	1.860	1.860	1.860
Fabric group 2	1.995	1.995	1.995
Fabric group 3	2.065	2.065	2.065
Fabric group 4	2.265	2.265	2.265
Fabric group 5	2.715	2.715	2.715
C.O.M. fabric	1.860	1.860	1.860
Leather group 1	2.815	2.815	2.815
Leather group 2	3.115	3.115	3.115
Leather group 3	3.575	3.575	3.575
Leather group 4	3.805	3.805	3.805
Leather group 5	4.380	4.380	4.380
C.O.M. leather	2.815	2.815	2.815

Fabric consumption: 1,9 m. Leather consumption: 6 m²

Leather consumption plinth: 2,25 m²

Extra charge for

Leather plinth if upholstery is in fabric:	+416
Extra sitting height (2,5 cm):	+206

Certifications

EN 1022:2005, EN 16139:2013 (L2)

Recommended upholstery

Fabric group 1	Grand Linen, Remix, Capture, Bardal, Re-wool, Linara, Natural Linen, Erik
Fabric group 2	Hallingdal, Barnum, Loop, Steelcut Trio, Fiord, Ruskin
Fabric group 3	Divina Melange, Vidar, Foss, Clay
Fabric group 4	Elle, Sisu, Safire
Fabric group 5	Gentle
Leather group 1	Omni
Leather group 2	Primo, Trace
Leather group 3	Max
Leather group 4	Nubuck, Vegeta, Organic, Cera

Model 4502

Delphi Elements Seat module 120x85 cm



Designed by Hannes Wettstein, 2007

Wide seat module for Delphi modular sofa system. Fully upholstered in fabric or leather. Inner frame of wood with nozag springs, cold cured foam and duvet of down and foam granulate mixture. Aluminum or solid wood base. Modules can be independently rearranged.

Modeldetails

0,8 m³ Packaging dimensions:
59 kg / 54 kg L: 95 cm W: 64 cm H: 125 cm

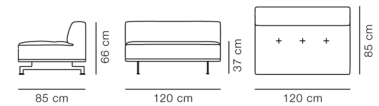

Order configuration

Plinth: Oak light oil or same as other upholstery or leather (98 black, 95 cognac, 90 natural).

	Brushed aluminium	Oak light oil	Black
Fabric group 1	2.425	2.425	2.425
Fabric group 2	2.650	2.650	2.650
Fabric group 3	2.760	2.760	2.760
Fabric group 4	3.090	3.090	3.090
Fabric group 5	3.710	3.710	3.710
C.O.M. fabric	2.425	2.425	2.425
Leather group 1	4.015	4.015	4.015
Leather group 2	4.500	4.500	4.500
Leather group 3	5.260	5.260	5.260
Leather group 4	5.635	5.635	5.635
Leather group 5	6.485	6.485	6.485
C.O.M. leather	4.015	4.015	4.015

Fabric consumption: 3,6 m. Leather consumption: 10 m²

Leather consumption plinth: 2,25 m²

Extra charge for

Leather plinth if upholstery is in fabric: +416
Extra sitting height (2,5 cm): +206

Certifications

EN 1022:2005, EN 16139:2013 (L2)

Recommended upholstery

Fabric group 1 Grand Linen, Remix, Capture, Bardal, Re-wool, Linara, Natural Linen, Erik
Fabric group 2 Hallingdal, Barnum, Loop, Steelcut Trio, Fiord, Ruskin
Fabric group 3 Divina Melange, Vidar, Foss, Clay
Fabric group 4 Elle, Sisu, Safire
Fabric group 5 Gentle
Leather group 1 Omni
Leather group 2 Primo, Trace
Leather group 3 Max
Leather group 4 Nubuck, Vegeta, Organic, Cera

Model 4506

Delphi Elements Seat module 85x85 cm



Designed by Hannes Wettstein, 2007

Short seat module for Delphi modular sofa system. Fully upholstered in fabric or leather. Inner frame of wood with nozag springs, cold cured foam and duvet of down and foam granulate mixture. Aluminum or solid wood base. Modules can be independently rearranged.

Modeldetails

0,6 m³ Packaging dimensions:
45 kg / 40 kg L: 95 cm W: 64 cm H: 100 cm

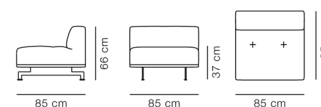

Essential Assortment

Item number	Upholstery	Legs	Price
45060401009098510100	Steelcut Trio, 213	Brushed aluminium	2.245
45065009809098510100	Leather Max 98, Black	Brushed aluminium	3.800
45065084109098510100	Leather Cera 905, Russet brown	Brushed aluminium	4.410

Essential variants only delivered with HR foam

Order configuration

Plinth: Oak light oil or same as other upholstery or leather (98 black, 95 cognac, 90 natural).

	Brushed aluminium	Oak light oil	Black
Fabric group 1	2.170	2.170	2.170
Fabric group 2	2.315	2.315	2.315
Fabric group 3	2.450	2.450	2.450
Fabric group 4	2.655	2.655	2.655
Fabric group 5	3.150	3.150	3.150
C.O.M. fabric	2.170	2.170	2.170
Leather group 1	3.040	3.040	3.040
Leather group 2	3.355	3.355	3.355
Leather group 3	3.865	3.865	3.865
Leather group 4	4.560	4.560	4.560
Leather group 5	5.765	5.765	5.765
C.O.M. leather	3.040	3.040	3.040

Fabric consumption: 2,9 m. Leather consumption: 7,5 m²

Leather consumption plinth: 2,25 m²

Extra charge for

Leather plinth if upholstery is in fabric:	+416
Extra sitting height (2,5 cm):	+206

Certifications

EN 1022:2005, EN 16139:2013 (L2)

Recommended upholstery

Fabric group 1	Grand Linen, Remix, Capture, Bardal, Re-wool, Linara, Natural Linen, Erik
Fabric group 2	Hallingdal, Barnum, Loop, Steelcut Trio, Fiord, Ruskin
Fabric group 3	Divina Melange, Vidar, Foss, Clay
Fabric group 4	Elle, Sisu, Safire
Fabric group 5	Gentle
Leather group 1	Omni
Leather group 2	Primo, Trace
Leather group 3	Max
Leather group 4	Nubuck, Vegeta, Organic, Cera

Model 4503

Delphi Elements Side chaise module 120x85 cm



Designed by Hannes Wettstein, 2007

Side module with extended depth for L-configuration of Delphi modular sofa. Fully upholstered in fabric or leather. Inner frame of wood with nozag springs, cold cured foam and duvet of down and foam granulate mixture. Aluminum or solid wood base. The backrest of the module is designed to be used in connection with main sofa armrest. Modules can be independently rearranged.

Model details

0,8 m³ Packaging dimensions:
59 kg / 54 kg L: 125 cm W: 95 cm H: 64 cm

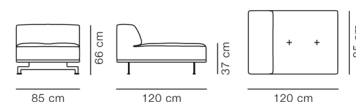

Order configuration

Plinth: Oak light oil or same as other upholstery or leather (98 black, 95 cognac, 90 natural).

	Brushed aluminium	Oak light oil	Black
Fabric group 1	2.400	2.400	2.400
Fabric group 2	2.610	2.610	2.610
Fabric group 3	2.710	2.710	2.710
Fabric group 4	3.015	3.015	3.015
Fabric group 5	3.620	3.620	3.620
C.O.M. fabric	2.400	2.400	2.400
Leather group 1	3.855	3.855	3.855
Leather group 2	4.305	4.305	4.305
Leather group 3	5.005	5.005	5.005
Leather group 4	5.355	5.355	5.355
Leather group 5	6.155	6.155	6.155
C.O.M. leather	3.855	3.855	3.855

Fabric consumption: 3,3 m. Leather consumption: 10 m²

Leather consumption plinth: 2,25 m²

Extra charge for

Leather plinth if upholstery is in fabric: +416
Extra sitting height (2,5 cm): +206

Certifications

EN 1022:2005, EN 16139:2013 (L2)

Recommended upholstery

Fabric group 0	Connect
Fabric group 1	Grand Linen, Linara, Bardal, Capture, Remix, Re-wool, Erik
Fabric group 2	Hallingdal, Barnum, Steelcut Trio, Fiord, Ruskin, Loop
Fabric group 3	Vidar, Clay, Divina Melange, Foss
Fabric group 4	Sisu, Elle, Safire
Fabric group 5	Gentle
Leather group 4	Cera

Model P4500

Delphi Accessories Decorative cushion



Designed by Hannes Wettstein, 2007

Loose back cushions in foam core with down wrap available in textile or leather.
Available in two sizes. The smallest available with a steel frame to avoid the cushion
skidding when upholstered in leather.

Modeldetails

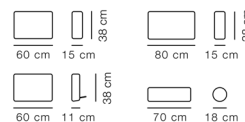

Essential Assortment

Item number	Upholstery	Cushion	Cushion	Price
P450004010011100	Steelcut Trio, 213	Cushion wall-edged	H38 x W60 x D15 cm	295
P450004010011200	Steelcut Trio, 213	Cushion wall-edged	H38 x W80 x D15 cm	295
P450050098011100	Leather Max 98, Black	Cushion wall-edged	H38 x W60 x D15 cm	590
P450050098011200	Leather Max 98, Black	Cushion wall-edged	H38 x W80 x D15 cm	590
P450050841011100	Leather Cera 905, Russet brown	Cushion wall-edged	H38 x W60 x D15 cm	705
P450050841011200	Leather Cera 905, Russet brown	Cushion wall-edged	H38 x W80 x D15 cm	705

Essential variants only delivered with HR foam

Order configuration

	Short cushion 38 x 60 cm	Short cushion w. bracket 38 x 60 cm	Long cushion 38 x 80 cm	Neck cushion Ø18 x 70 cm
Fabric group 1	255	315	290	280
Fabric group 2	305	365	355	330
Fabric group 3	330	385	385	355
Fabric group 4	400	460	475	430
Fabric group 5	480	550	570	520
C.O.M. fabric	255	315	290	280
Leather group 1	470	665	555	555
Leather group 2	540	770	645	645
Leather group 3	655	935	780	780
Leather group 4	710	1.015	850	850
Leather group 5	815	1.165	975	980
C.O.M. leather	470	665	555	555

Fabric and leather consumption:

Short cushion, 0,75 m / 1,2 m², Long cushion, 0,95 m / 2,0 m²

Back cushion, 0,75 m / 1,2 m², Neck cushion, 0,80 m / 1,5 m²

Recommended upholstery

Fabric group 1	Grand Linen, Linara, Bardal, Capture, Remix, Re-wool, Natural Linen, Erik
Fabric group 2	Hallingdal, Barnum, Steelcut Trio, Fiord, Ruskin, Loop
Fabric group 3	Vidar, Clay, Divina Melange, Foss
Fabric group 4	Sisu, Elle, Safire
Fabric group 5	Gentle
Leather group 1	Omni
Leather group 2	Primo, Trace
Leather group 3	Max
Leather group 4	Nubuck, Vegeta, Organic, Cera

Model 450A

Delphi Elements Configuration A, 325 x 170cm

Modeldetails

📦 2,8 m³	Packaging dimensions:
📦 227 kg / 207 kg	L: 125/125/100/125 cm W: 88/95/95/95 cm H: 52/64/64/64 cm



Designed by Hannes Wettstein, 2007

Delphi modular sofa system. Fully upholstered in fabric or leather. Inner frame of wood with nozag springs, cold cured foam and duvet of down and foam granulate mixture. Aluminum or solid wood base. Modules can be independently rearranged.

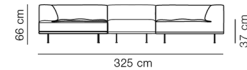

Essential Assortment

Item number	Upholstery	Legs	Price
450A0401009000510100	Steelcut Trio, 213	Brushed aluminium	10.040
450A5009809000510100	Leather Max 98, Black	Brushed aluminium	17.135
450A5084109000510100	Leather Cera 905, Russet brown	Brushed aluminium	20.095

Essential variants only delivered with HR foam

Order configuration

Base: Brushed aluminium, black or Oak light oil

Fabric group 1	9.675
Fabric group 2	10.390
Fabric group 3	11.060
Fabric group 4	12.065
Fabric group 5	14.495
C.O.M. fabric	9.675
Leather group 1	13.615
Leather group 2	15.095
Leather group 3	17.465
Leather group 4	20.845
Leather group 5	26.590
C.O.M. leather	13.615

Fabric consumption: 13,9 m. Leather consumption: 34 m²

Extra charge for

Leather plinth if upholstery is in fabric:	+1.664
Extra sitting height (2,5 cm):	+824

Recommended upholstery

Fabric group 1	Grand Linen, Linara, Bardal, Capture, Remix, Re-wool, Natural Linen, Erik
Fabric group 2	Hallingdal, Barnum, Steelcut Trio, Fiord, Ruskin, Loop
Fabric group 3	Vidar, Clay, Divina Melange, Foss
Fabric group 4	Sisu, Elle, Safire
Fabric group 5	Gentle
Leather group 1	Omni
Leather group 2	Primo, Trace
Leather group 3	Max
Leather group 4	Nubuck, Vegeta, Organic, Cera

Model 450B

Delphi Elements Configuration B, 265 x 205cm

Modeldetails

📦 2,5 m³	Packaging dimensions:
📦 200 kg / 185 kg	L: 125/101/185 cm W: 95/95/95 cm H: 64/64/64 cm

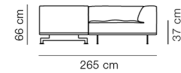

Designed by Hannes Wettstein, 2007

Delphi modular sofa system. Fully upholstered in fabric or leather. Inner frame of wood with nozag springs, cold cured foam and duvet of down and foam granulate mixture. Aluminum or solid wood base. Modules can be independently rearranged.

Essential Assortment

Item number	Upholstery	Legs	Price
450B0401009000510100	Steelcut Trio, 213	Brushed aluminium	9.750
450B5009809000510100	Leather Max 98, Black	Brushed aluminium	18.180
450B5084109000510100	Leather Cera 905, Russet brown	Brushed aluminium	19.960

Essential variants only delivered with HR foam

Order configuration

Base: Brushed aluminium, black or Oak light oil

Fabric group 1	9.070
Fabric group 2	9.855
Fabric group 3	10.335
Fabric group 4	11.460
Fabric group 5	13.815
C.O.M. fabric	9.070
Leather group 1	14.075
Leather group 2	15.720
Leather group 3	18.280
Leather group 4	20.185
Leather group 5	24.005
C.O.M. leather	14.075

Fabric consumption: 13 m. Leather consumption: 30 m²

Extra charge for

Leather plinth if upholstery is in fabric:	+1.248
Extra sitting height (2,5 cm):	+618

Recommended upholstery

Fabric group 1	Grand Linen, Linara, Bardal, Capture, Remix, Re-wool, Natural Linen, Erik
Fabric group 2	Hallingdal, Barnum, Steelcut Trio, Fiord, Ruskin, Loop
Fabric group 3	Vidar, Clay, Divina Melange, Foss
Fabric group 4	Sisu, Elle, Safire
Fabric group 5	Gentle
Leather group 1	Omni
Leather group 2	Primo, Trace
Leather group 3	Max
Leather group 4	Nubuck, Vegeta, Organic, Cera

Model 450D

Delphi Elements Configuration D, 265 x 205cm



Designed by Hannes Wettstein, 2007

Delphi modular sofa system. Fully upholstered in fabric or leather. Inner frame of wood with nozag springs, cold cured foam and duvet of down and foam granulate mixture. Aluminum or solid wood base. Modules can be independently rearranged.

Modeldetails

📦 2,5 m³	Packaging dimensions:
📦 307 kg / 282 kg	L: 185/101/125 cm W: 95/95/95 cm H: 64/64/64 cm

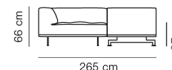

Essential Assortment

Item number	Upholstery	Legs	Price
450D0401009000510100	Steelcut Trio, 213	Brushed aluminium	9.750
450D5009809000510100	Leather Max 98, Black	Brushed aluminium	18.180
450D5084109000510100	Leather Cera 905, Russet brown	Brushed aluminium	19.960

Essential variants only delivered with HR foam

Order configuration

Base: Brushed aluminium, black or Oak light oil

Fabric group 1	9.070
Fabric group 2	9.855
Fabric group 3	10.335
Fabric group 4	11.460
Fabric group 5	13.815
C.O.M. fabric	9.070
Leather group 1	14.075
Leather group 2	15.720
Leather group 3	18.280
Leather group 4	20.185
Leather group 5	24.005
C.O.M. leather	14.075

Fabric consumption: 18,6 m. Leather consumption: 50 m²

Extra charge for

Leather plinth if upholstery is in fabric:	+2.080
Extra sitting height (2,5 cm):	+618



Recommended upholstery

Fabric group 1	Grand Linen, Linara, Bardal, Capture, Remix, Re-wool, Natural Linen, Erik
Fabric group 2	Hallingdal, Barnum, Steelcut Trio, Fiord, Ruskin, Loop
Fabric group 3	Vidar, Clay, Divina Melange, Foss
Fabric group 4	Sisu, Elle, Safire
Fabric group 5	Gentle
Leather group 1	Omni
Leather group 2	Primo, Trace
Leather group 3	Max
Leather group 4	Nubuck, Vegeta, Organic, Cera

Model 450C

Delphi Elements Configuration C, 360 x 255cm

Modeldetails

 4 m³ Packaging dimensions:
 200 kg / 185 kg L: 125/125/125/125/125 cm W: 95/95/95/95/95 cm H: 64/64/64/64/64 cm



Designed by Hannes Wettstein, 2007

Delphi modular sofa system. Fully upholstered in fabric or leather. Inner frame of wood with nozag springs, cold cured foam and duvet of down and foam granulate mixture. Aluminum or solid wood base. Modules can be independently rearranged.

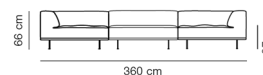

Essential Assortment

Item number	Upholstery	Legs	Price
450C0401009000510100	Steelcut Trio, 213	Brushed aluminium	13.640
450C5009809000510100	Leather Max 98, Black	Brushed aluminium	25.340
450C5084109000510100	Leather Cera 905, Russet brown	Brushed aluminium	28.145

Essential variants only delivered with HR foam

Order configuration

Base: Brushed aluminium, black or Oak light oil

Fabric group 1	12.755
Fabric group 2	13.850
Fabric group 3	14.580
Fabric group 4	16.150
Fabric group 5	19.510
C.O.M. fabric	12.755
Leather group 1	19.635
Leather group 2	21.930
Leather group 3	25.540
Leather group 4	28.595
Leather group 5	34.475
C.O.M. leather	19.635

Fabric consumption: 13 m. Leather consumption: 30 m²

Extra charge for

Leather plinth if upholstery is in fabric:	+2.080
Extra sitting height (2,5 cm):	+1.030

Recommended upholstery

Fabric group 1	Grand Linen, Linara, Bardal, Capture, Remix, Re-wool, Natural Linen, Erik
Fabric group 2	Hallingdal, Barnum, Steelcut Trio, Fiord, Ruskin, Loop
Fabric group 3	Vidar, Clay, Divina Melange, Foss
Fabric group 4	Sisu, Elle, Safire
Fabric group 5	Gentle
Leather group 1	Omni
Leather group 2	Primo, Trace
Leather group 3	Max
Leather group 4	Nubuck, Vegeta, Organic, Cera

Delphi Elements – Overview

4501 End module 120x85 cm, Arm L or R

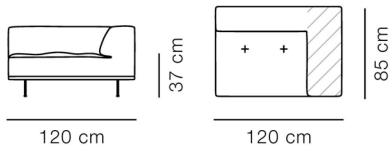
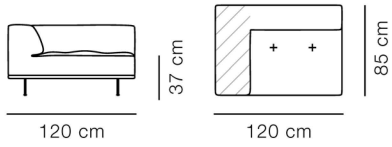

4514 End module 180x85 cm, Arm L or R

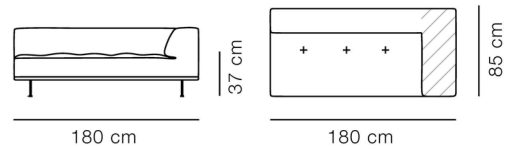
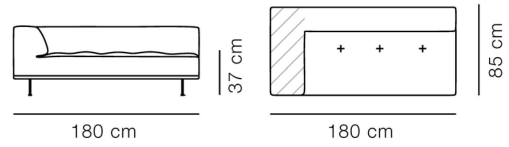

4502 Seat module 120x85 cm

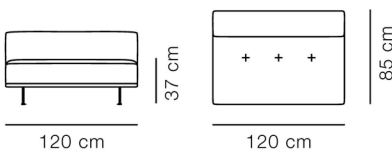

4506 Seat module 85x85 cm

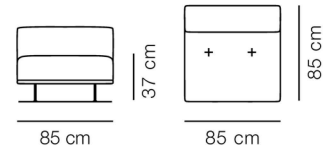

4503 Side chaise module 120x85 cm

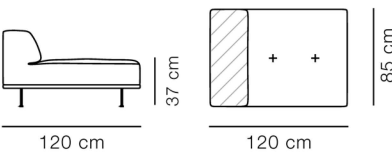

*Extended arm

4513 Corner module 85x85 cm

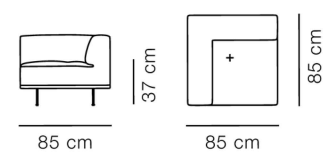

4504 Ottoman 120x85 cm

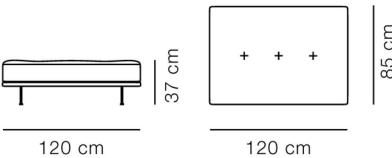

4505 Ottoman 85x85 cm

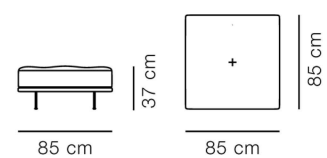

Delphi Elements – Configuration overview

Model 450A, Configuration A
 MODEL 4504 / 4501 (left) / 4506 / 4501 (right)

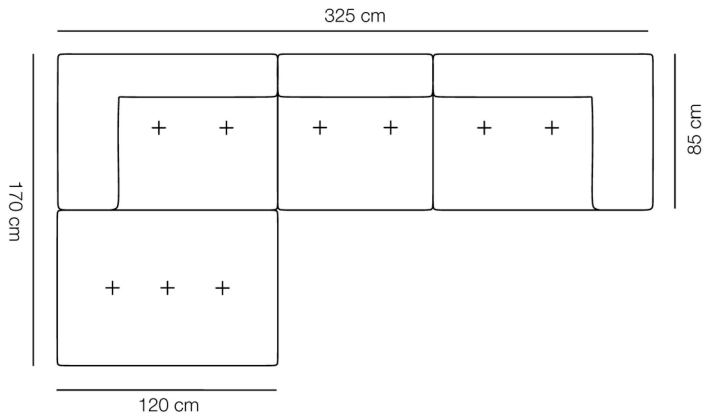

Model 450B, Configuration B
 MODEL 4501 (left) / 4513 / 4514 (right)

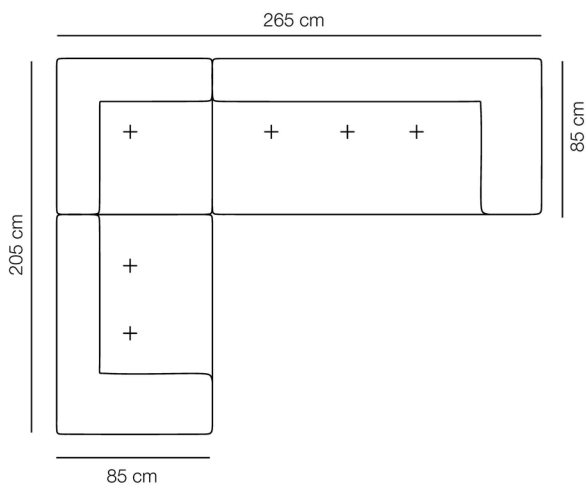

Model 450D, Configuration D
 MODEL 4514 (left) / 4513 / 4501 (right)

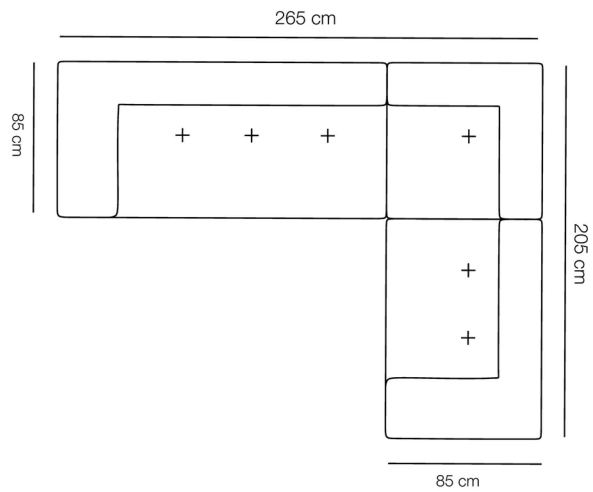

Model 450C, Configuration C
 MODEL 4503 / 4503 / 4501 (left) / 4502 / 4501 (right)

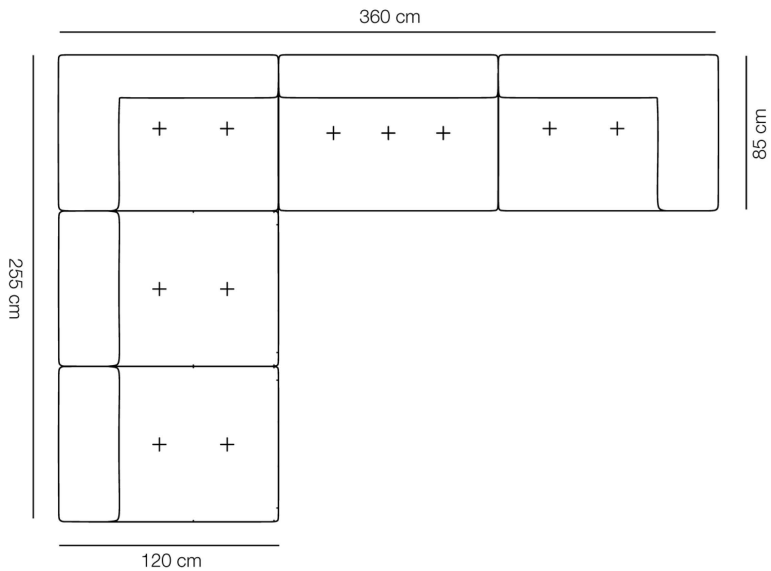

For customer's own configuration, please attach to the order a visual sketch of the desired layout

Model 2042

EJ220 Sofa 2 seater, 76 cm cushions



Designed by Erik Jørgensen, 1970

Sofa with separate arm, seat and back cushions. Inner frame of wood with nozag springs. Available in fabric or leather. Cushions available in foam core with down wrap. External cover available as non-removable. Cushion covers are removable. Legs in solid wood or steel.

Modeldetails

1 m³ Packaging dimensions:
49 kg / 42 kg L: 168 cm W: 95 cm H: 64 cm

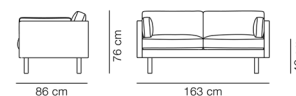

Essential Assortment

Item number	Upholstery	Legs	Price
20424064018021703110	Erik 3790 Linen	Oak soap treated, round legs	2.950
20424064218021703110	Erik 9998 Broken Grey	Oak soap treated, round legs	2.950
20421930018021703110	Re-Wool 198	Oak soap treated, round legs	3.075
20421931118021703110	Re-Wool 128	Oak soap treated, round legs	3.075
20425130118021704110	Leather Omni 301, Black	Brushed chrome, round legs	6.025
20425009518021704110	Leather Max 95, Cognac	Brushed chrome, round legs	8.440

Essential variants only delivered with HR foam

Order configuration

Cushion filling: Down cover.

Legs: Round wooden legs in either Oak soap, Oak lacquered or Smoked oak stain

Round steel legs in either Brushed chrome or Black powder coat.

Fabric group 1	3.350
Fabric group 2	3.930
Fabric group 3	4.210
Fabric group 4	5.040
Fabric group 5	6.050
C.O.M. fabric	3.350
Leather group 1	6.655
Leather group 2	7.675
Leather group 3	9.255
Leather group 4	10.040
Leather group 5	11.545
C.O.M. leather	6.655

Fabric consumption: 9,8 m. Leather consumption: 19,5 m²

Extra charge for

Removable cover (fabric only) add 1 m extra in Fabric consumption: +353

Certifications

EN 1022:2005, EN 16139:2013 (L2)

Recommended upholstery

Fabric group 1	Grand Linen, Remix, Capture, Bardal, Re-wool, Linara, Natural Linen, Erik
Fabric group 2	Hallingdal, Barnum, Loop, Steelcut Trio, Fiord, Ruskin, Savoy
Fabric group 3	Divina Melange, Vidar, Sunniva, Foss, Clay
Fabric group 4	Cotil, Elle, Sisu, Safire
Fabric group 5	Grand Mohair, Gentle
Leather group 1	Omni
Leather group 2	Primo, Trace
Leather group 3	Max
Leather group 4	Nubuck, Vegeta, Organic, Cera

Model 2052

EJ220 Sofa 2 seater, 86 cm cushions



Designed by Erik Jørgensen, 1970

Sofa with separate arm, seat and back cushions. Inner frame of wood with nozag springs. Available in fabric or leather. Cushions available in foam core with down wrap. External cover available as non-removable (standard) or removable. Cushion covers are removable. Legs in solid wood or steel.

Modeldetails

1,15 m³ Packaging dimensions:
54 kg / 47 kg L: 217 cm W: 95 cm H: 64 cm

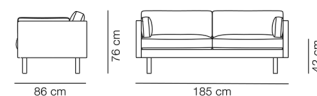

Essential Assortment

Item number	Upholstery	Legs	Price
20524064018021703110	Erik 3790 Linen	Oak soap treated, round legs	3.070
20524064218021703110	Erik 9998 Broken Grey	Oak soap treated, round legs	3.070
20521930018021703110	Re-Wool 198	Oak soap treated, round legs	3.425
20521931118021703110	Re-Wool 128	Oak soap treated, round legs	3.425
20525130118021704110	Leather Omni 301, Black	Brushed chrome, round legs	6.735
20525009518021704110	Leather Max 95, Cognac	Brushed chrome, round legs	9.220

Essential variants only delivered with HR foam

Order configuration

Cushion filling: Down cover.

Legs: Round wooden legs in either Oak soap, Oak lacquered or Smoked oak stain

Round steel legs in either Brushed chrome or Black powder coat.

Fabric group 1	3.645
Fabric group 2	4.270
Fabric group 3	4.570
Fabric group 4	5.475
Fabric group 5	6.575
C.O.M. fabric	3.645
Leather group 1	7.230
Leather group 2	8.335
Leather group 3	10.050
Leather group 4	10.900
Leather group 5	12.535
C.O.M. leather	7.230

Fabric consumption: 9,5 m. Leather consumption: 19,5 m²

Extra charge for

Removable cover (fabric only) add 1 m extra in Fabric consumption: +353

Certifications

EN 1022:2005, EN 16139:2013 (L2)

Recommended upholstery

Fabric group 1	Grand Linen, Remix, Capture, Bardal, Re-wool, Linara, Natural Linen, Erik
Fabric group 2	Hallingdal, Barnum, Loop, Steelcut Trio, Fiord, Ruskin, Savoy
Fabric group 3	Divina Melange, Vidar, Sunniva, Foss, Clay
Fabric group 4	Cotil, Elle, Sisu, Safire
Fabric group 5	Grand Mohair, Gentle
Leather group 1	Omni
Leather group 2	Primo, Trace
Leather group 3	Max
Leather group 4	Nubuck, Vegeta, Organic, Cera

Model 2062

EJ220 Sofa 2 seater, 100 cm cushions



Designed by Erik Jørgensen, 1970

Sofa with separate arm, seat and back cushions. Inner frame of wood with nozag springs. Available in fabric or leather. Cushions available in foam core with down wrap. External cover available as non-removable (standard) or removable. Cushion covers are removable. Legs in solid wood or steel.

Modeldetails

1,33 m³ Packaging dimensions:
63 kg / 57 kg L: 217 cm W: 95 cm H: 64 cm

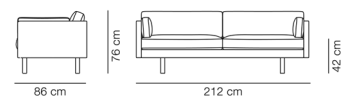

Essential Assortment

Item number	Upholstery	Legs	Price
20624064018021703110	Erik 3790 Linen	Oak soap treated, round legs	3.190
20624064218021703110	Erik 9998 Broken Grey	Oak soap treated, round legs	3.190
20621930018021703110	Re-Wool 198	Oak soap treated, round legs	3.310
20621931118021703110	Re-Wool 128	Oak soap treated, round legs	3.310
20625130118021704110	Leather Omni 301, Black	Brushed chrome, round legs	7.685
20625009518021704110	Leather Max 95, Cognac	Brushed chrome, round legs	10.225

Essential variants only delivered with HR foam

Order configuration

Cushion filling: Down cover.

Legs: Round wooden legs in either Oak soap, Oak lacquered or Smoked oak stain

Round steel legs in either Brushed chrome or Black powder coat.

Fabric group 1	4.170
Fabric group 2	4.890
Fabric group 3	5.235
Fabric group 4	6.275
Fabric group 5	7.530
C.O.M. fabric	4.170
Leather group 1	8.285
Leather group 2	9.550
Leather group 3	11.520
Leather group 4	12.500
Leather group 5	14.375
C.O.M. leather	8.285

Fabric consumption: 10,5 m. Leather consumption: 20 m²

Alternative leg placement is possible.

Extra charge for

Removable cover (fabric only) add 1 m extra in Fabric consumption: +353

Certifications

EN 1022:2005, EN 16139:2013 (L2)

Recommended upholstery

Fabric group 1	Grand Linen, Remix, Capture, Bardal, Re-wool, Linara, Natural Linen, Erik
Fabric group 2	Hallingdal, Barnum, Loop, Steelcut Trio, Fiord, Ruskin, Savoy
Fabric group 3	Divina Melange, Vidar, Sunniva, Foss, Clay
Fabric group 4	Cotil, Elle, Sisu, Safire
Fabric group 5	Grand Mohair, Gentle
Leather group 1	Omni
Leather group 2	Primo, Trace
Leather group 3	Max
Leather group 4	Nubuck, Vegeta, Organic, Cera

Model 2033

EJ220 Sofa 3 seater, 67 cm cushions



Designed by Erik Jørgensen, 1970

Sofa with separate arm, seat and back cushions. Inner frame of wood with nozag springs. Available in fabric or leather. Cushions available in foam core with down wrap. External cover available as non-removable (standard) or removable. Cushion covers are removable. interchangeable legs in solid wood or steel.

Modeldetails

1,32 m³ Packaging dimensions:
63 kg / 57 kg L: 217 cm W: 95 cm H: 64 cm

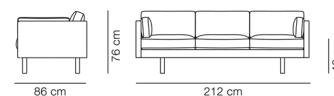

Essential Assortment

Item number	Upholstery	Legs	Price
20334064018021703110	Erik 3790 Linen	Oak soap treated, round legs	3.615
20334064218021703110	Erik 9998 Broken Grey	Oak soap treated, round legs	3.615
20331930018021703110	Re-Wool 198	Oak soap treated, round legs	3.855
20331931118021703110	Re-Wool 128	Oak soap treated, round legs	3.855
20335130118021704110	Leather Omni 301, Black	Brushed chrome, round legs	7.715
20335009518021704110	Leather Max 95, Cognac	Brushed chrome, round legs	10.310

Essential variants only delivered with HR foam

Order configuration

Cushion filling: Down cover.

Legs: Round wooden legs in either Oak soap, Oak lacquered or Smoked oak stain

Round steel legs in either Brushed chrome or Black powder coat.

Fabric group 1	4.210
Fabric group 2	4.940
Fabric group 3	5.290
Fabric group 4	6.340
Fabric group 5	7.610
C.O.M. fabric	4.210
Leather group 1	8.375
Leather group 2	9.655
Leather group 3	11.645
Leather group 4	12.630
Leather group 5	14.525
C.O.M. leather	8.375

Fabric consumption: 10,5 m. Leather consumption: 24 m²

Alternative leg placement is possible.

Extra charge for

Removable cover (fabric only) add 1 m extra in Fabric consumption: +353

Certifications

EN 1022:2005, EN 16139:2013 (L2)

Recommended upholstery

Fabric group 1	Grand Linen, Remix, Capture, Bardal, Re-wool, Linara, Natural Linen, Erik
Fabric group 2	Hallingdal, Barnum, Loop, Steelcut Trio, Fiord, Ruskin, Savoy
Fabric group 3	Divina Melange, Vidar, Sunniva, Foss, Clay
Fabric group 4	Cotil, Elle, Sisu, Safire
Fabric group 5	Grand Mohair, Gentle
Leather group 1	Omni
Leather group 2	Primo, Trace
Leather group 3	Max
Leather group 4	Nubuck, Vegeta, Organic, Cera

Model 8052

EJ280 Sofa 2 seater, 86 cm cushions



Designed by Erik Jørgensen Studio, 2010

Sofa with separate arm, seat and back cushions. Inner frame of wood with nozag springs. Available in fabric or leather. Cushions in foam core with down wrap. External cover available as non-removable (standard) or removable. Cushion covers are removable. Sledge legs in steel in two different heights, or legs in solid wood or steel. Available in two heights, please specify height.

Modeldetails

1,3 m³ Packaging dimensions:
63 kg / 57 kg L: 217 cm W: 95 cm H: 64 cm



Essential Assortment

Item number	Upholstery	Legs	Price
80521930017021711010	Re-Wool 198	Brushed chrome, sledge base (High)	3.749
80521931117021711010	Re-Wool 128	Brushed chrome, sledge base (High)	3.749
80524064017021711010	Erik 3790 Linen	Brushed chrome, sledge base (High)	3.749
80524064217021711010	Erik 9998 Broken Grey	Brushed chrome, sledge base (High)	3.749
80525130117021711010	Leather Omni 301, Black	Brushed chrome, sledge base (High)	7.835
80525009517021711010	Leather Max 95, Cognac	Brushed chrome, sledge base (High)	9.635

Essential variants only delivered with HR foam

Order configuration

Legs: Round wooden legs in either oak soap, oak lacquer or oak smoke stained.

Round steel legs in either brushed chrome or black powder coating.

Metal frame in brushed chrome.

Fabric group 1	4.185
Fabric group 2	4.870
Fabric group 3	5.205
Fabric group 4	6.200
Fabric group 5	7.440
C.O.M. fabric	4.185
Leather group 1	8.045
Leather group 2	9.265
Leather group 3	11.165
Leather group 4	12.105
Leather group 5	13.925
C.O.M. leather	8.045

Fabric consumption: 10,8 m. Leather consumption: 20 m²

Extra charge for

Removable cover (fabric only) add 1 m extra in Fabric consumption: +353

Certifications

EN 1022:2005, EN 16139:2013 (L2)

Recommended upholstery

Fabric group 1	Grand Linen, Remix, Capture, Bardal, Re-wool, Linara, Natural Linen, Erik
Fabric group 2	Hallingdal, Barnum, Loop, Steelcut Trio, Fiord, Ruskin, Savoy
Fabric group 3	Divina Melange, Vidar, Sunniva, Foss, Clay
Fabric group 4	Cotil, Elle, Sisu, Safire
Fabric group 5	Grand Mohair, Gentle
Leather group 1	Omni
Leather group 2	Primo
Leather group 3	Max
Leather group 4	Nubuck, Vegeta, Organic, Cera

Model 8062

EJ280 Sofa 2 seater, 100 cm cushions



Designed by Erik Jørgensen Studio, 2010

Sofa with separate arm, seat and back cushions. Inner frame of wood with nozag springs. Available in fabric or leather. Cushions in foam core with down wrap. External cover available as non-removable (standard) or removable. Cushion covers are removable. Sledge legs in steel in two different heights, or legs in solid wood or steel. Available in two heights, please specify height.

Modeldetails

1,49 m³ Packaging dimensions:
68 kg / L: 245 cm W: 95 cm H: 64 cm
62 kg

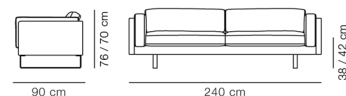

Essential Assortment

Item number	Upholstery	Legs	Price
80621930017021711010	Re-Wool 198	Brushed chrome, sledge base (High)	4.166
80621931117021711010	Re-Wool 128	Brushed chrome, sledge base (High)	4.166
80624064017021711010	Erik 3790 Linen	Brushed chrome, sledge base (High)	4.166
80624064217021711010	Erik 9998 Broken Grey	Brushed chrome, sledge base (High)	4.166
80625130117021711010	Leather Omni 301, Black	Brushed chrome, sledge base (High)	8.440
80625009517021711010	Leather Max 95, Cognac	Brushed chrome, sledge base (High)	10.250

Essential variants only delivered with HR foam

Order configuration

Legs: Round wooden legs in either oak soap, oak lacquer or oak smoke stained.

Round steel legs in either brushed chrome or black powder coating.

Metal frame in brushed chrome.

Fabric group 1	4.635
Fabric group 2	5.375
Fabric group 3	5.730
Fabric group 4	6.795
Fabric group 5	8.155
C.O.M. fabric	4.635
Leather group 1	8.970
Leather group 2	10.330
Leather group 3	12.440
Leather group 4	13.485
Leather group 5	15.510
C.O.M. leather	8.970

Fabric consumption: 11,5 m. Leather consumption: 23,5 m²

Extra charge for

Removable cover (fabric only) add 1 m extra in Fabric consumption: +353

Certifications

EN 1022:2005, EN 16139:2013 (L2)

Recommended upholstery

Fabric group 1	Erik, Grand Linen, Linara, Bardal, Capture, Remix, Natural Linen, Re-wool
Fabric group 2	Hallingdal, Savoy, Barnum, Steelcut Trio, Fiord, Ruskin, Loop
Fabric group 3	Vidar, Clay, Sunniva, Divina Melange, Foss
Fabric group 4	Sisu, Elle, Safire, Cotil
Fabric group 5	Gentle, Grand Mohair

Model 8072

EJ280 Sofa 2 seater, 120 cm cushions



Designed by Erik Jørgensen Studio, 2010

Sofa delivered in two modules with separate arm, seat and back cushions. Inner frame of wood with nozag springs. Available in fabric. Cushions in foam core with down wrap. External cover available as non-removable (standard) or removable. Cushion covers are removable. Sledge legs in steel in two different heights, or legs in solid wood or steel. Available in two heights, please specify height.

Modeldetails

1,7 m³ Packaging dimensions:
81 kg / 75 kg L: 285 cm W: 95 cm H: 64 cm

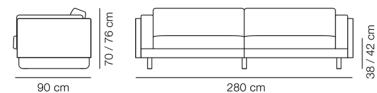

Essential Assortment

Item number	Upholstery	Legs	Price
807219300170217110A0	Re-Wool 198	Brushed chrome, sledge base (High)	5.910
807219311170217110A0	Re-Wool 128	Brushed chrome, sledge base (High)	5.910
807240640170217110A0	Erik 3790 Linen	Brushed chrome, sledge base (High)	5.910
807240642170217110A0	Erik 9998 Broken Grey	Brushed chrome, sledge base (High)	5.910

Essential variants only delivered with HR foam

Order configuration

Legs: Round wooden legs in either oak soap, oak lacquer or oak smoke stained.

Round steel legs in either brushed chrome or black powder coating.

Metal frame in brushed chrome.

Fabric group 1	6.175
Fabric group 2	6.835
Fabric group 3	7.490
Fabric group 4	8.765
Fabric group 5	10.120
C.O.M. fabric	6.175

Extra charge for

Removable cover (fabric only) add 1 m extra in Fabric consumption: +353

Certifications

FSC® certified

EN 1022:2005, EN 16139:2013 (L2)

Recommended upholstery

Fabric group 1	Grand Linen, Linara, Bardal, Capture, Remix, Natural Linen, Re-wool, Erik
Fabric group 2	Hallingdal, Savoy, Barnum, Steelcut Trio, Fiord, Ruskin, Loop
Fabric group 3	Vidar, Clay, Sunniva, Divina Melange, Foss
Fabric group 4	Sisu, Elle, Safire, Cotil
Fabric group 5	Gentle, Grand Mohair

Model 809B

EJ280 Elements Configuration B, 290 x 290cm

Modeldetails

2,81 m³ Packaging dimensions:
159 kg / L: 96/96/96 cm W: 65/65/65 cm H:
144 kg 177/98/177 cm



Designed by Erik Jørgensen Studio, 2018

Available in fabric only. The external cover is non-removable. Sledge legs in steel in two different heights, or legs in solid wood or steel. Available in two heights, please specify height.

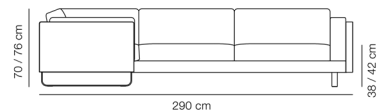

Order configuration

Legs: Round wooden legs in either oak soap, oak lacquer or oak smoke stained.

Round steel legs in either brushed chrome or black powder coating.

Metal frame in brushed chrome.

Fabric group 1	9.460
Fabric group 2	11.070
Fabric group 3	11.845
Fabric group 4	14.165
Fabric group 5	17.010
C.O.M. fabric	9.460

Fabric consumption: 20,3 m

Certifications

EN 1022:2005, EN 16139:2013 (L2)

Recommended upholstery

Fabric group 1	Grand Linen, Linara, Bardal, Capture, Remix, Natural Linen, Re-wool, Erik
Fabric group 2	Hallingdal, Savoy, Barnum, Steelcut Trio, Fiord, Ruskin, Loop
Fabric group 3	Vidar, Clay, Sunniva, Divina Melange, Foss
Fabric group 4	Sisu, Elle, Safire, Cotil
Fabric group 5	Gentle, Grand Mohair

Model 809C

EJ280 Elements Configuration C, 318 x 318cm



Designed by Erik Jørgensen Studio, 2018

Available in fabric only. The external cover is non-removable. Sledge legs in steel in two different heights, or legs in solid wood or steel. Available in two heights, please specify height.

Modeldetails

3,17 m³ Packaging dimensions:
183 kg / L: 96/96/96 cm W: 65/65/65 cm H:
166 kg 68/30/68 cm

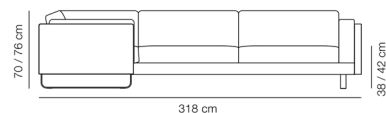

Order configuration

Legs: Round wooden legs in either oak soap, oak lacquer or oak smoke stained.

Round steel legs in either brushed chrome or black powder coating.

Metal frame in brushed chrome.

Fabric group 1	9.970
Fabric group 2	11.660
Fabric group 3	12.475
Fabric group 4	14.915
Fabric group 5	17.900
C.O.M. fabric	9.970

Fabric consumption: 21,9 m

Certifications

EN 1022:2005, EN 16139:2013 (L2)

Recommended upholstery

Fabric group 1	Grand Linen, Linara, Bardal, Capture, Remix, Natural Linen, Re-wool, Erik
Fabric group 2	Hallingdal, Savoy, Barnum, Steelcut Trio, Fiord, Ruskin, Loop
Fabric group 3	Vidar, Clay, Sunniva, Divina Melange, Foss
Fabric group 4	Sisu, Elle, Safire, Cotil
Fabric group 5	Gentle, Grand Mohair

Model 809D

EJ280 Elements Configuration D, 318cm x 218cm

Designed by Erik Jørgensen Studio, 2018

Available in fabric only. The external cover is non-removable. Sledge legs in steel in two different heights, or legs in solid wood or steel. Available in two heights, please specify height.

Modeldetails

2,55 m³ Packaging dimensions:
159 kg / L: 96/96/96 cm W: 65/65/65 cm H:
143 kg 105/98/205 cm

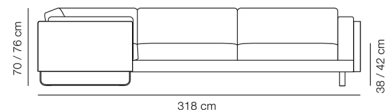

Order configuration

Legs: Round wooden legs in either oak soap, oak lacquer or oak smoke stained.

Round steel legs in either brushed chrome or black powder coating.

Metal frame in brushed chrome.

Fabric group 1	8.355
Fabric group 2	9.695
Fabric group 3	10.345
Fabric group 4	12.280
Fabric group 5	14.740
C.O.M. fabric	8.355

Fabric consumption: 18,5 m

Certifications

EN 1022:2005, EN 16139:2013 (L2)

Recommended upholstery

Fabric group 1	Grand Linen, Linara, Bardal, Capture, Remix, Natural Linen, Re-wool, Erik
Fabric group 2	Hallingdal, Savoy, Barnum, Steelcut Trio, Fiord, Ruskin, Loop
Fabric group 3	Vidar, Clay, Sunniva, Divina Melange, Foss
Fabric group 4	Sisu, Elle, Safire, Cotil
Fabric group 5	Gentle, Grand Mohair

Model 809E

EJ280 Elements Configuration E, 318 x 218cm

Designed by Erik Jørgensen Studio, 2018

Available in fabric only. The external cover is non-removable. Sledge legs in steel in two different heights, or legs in solid wood or steel. Available in two heights, please specify height.

Modeldetails

2,55 m³ Packaging dimensions:
159 kg / L: 96/96/96 cm W: 65/65/65 cm H:
143 kg 205/98/105 cm

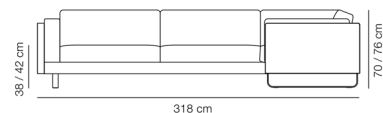

Order configuration

Legs: Round wooden legs in either oak soap, oak lacquer or oak smoke stained.

Round steel legs in either brushed chrome or black powder coating.

Metal frame in brushed chrome.

Fabric group 1	8.355
Fabric group 2	9.695
Fabric group 3	10.345
Fabric group 4	12.280
Fabric group 5	14.740
C.O.M. fabric	8.355

Fabric consumption: 18,5 m

Certifications

EN 1022:2005, EN 16139:2013 (L2)

Recommended upholstery

Fabric group 1	Grand Linen, Remix, Capture, Bardal, Re-wool, Linara, Natural Linen, Erik
Fabric group 2	Hallingdal, Barnum, Loop, Steelcut Trio, Fiord, Ruskin, Savoy
Fabric group 3	Divina Melange, Vidar, Sunniva, Foss, Clay
Fabric group 4	Cotil, Elle, Sisu, Safire
Fabric group 5	Grand Mohair, Gentle

Model 8099

EJ280 Elements Corner module

Modeldetails

0,61 m³ Packaging dimensions:
35 kg / 30 kg L: 96 cm W: 65 cm H: 98 cm



Designed by Erik Jørgensen Studio, 2018

Corner module for EJ280 Elements, including cushions. Available in fabric only. External cover is non-removable. Legs in solid wood or steel according to defined configuration. Modules cannot be rearranged after configuration. Available in two heights, please specify height.

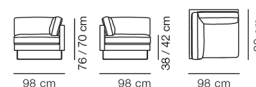

Order configuration

Legs: Round wooden legs in either oak soap, oak lacquer or oak smoke stained.

Round steel legs in either brushed chrome or black powder coating.

Metal frame in brushed chrome.

Fabric group 1	1.720
Fabric group 2	2.040
Fabric group 3	2.195
Fabric group 4	2.655
Fabric group 5	3.190
C.O.M. fabric	1.720

Fabric consumption: 4,3 m

Certifications

EN 1022:2005, EN 16139:2013 (L2)

Recommended upholstery

Fabric group 1	Grand Linen, Remix, Capture, Bardal, Re-wool, Linara, Natural Linen, Erik
Fabric group 2	Hallingdal, Barnum, Loop, Steelcut Trio, Fiord, Ruskin, Savoy
Fabric group 3	Divina Melange, Vidar, Sunniva, Foss, Clay
Fabric group 4	Cotil, Elle, Sisu, Safire
Fabric group 5	Grand Mohair, Gentle

Model 8066

EJ280 Elements End module, 1 seater 100, Arm L or R



Designed by Erik Jørgensen Studio, 2018

End module for EJ280 Elements, including cushions and arm in one side. Available in fabric only. The external cover is non-removable. Sledge legs in steel, or legs in solid wood or steel. Please specify height and arm position left or right hand side, facing the sofa. Available in two heights, please specify height.

Modeldetails

0,66 m³ Packaging dimensions:
50 kg / 45 kg L: 96 cm W: 65 cm H: 105 cm

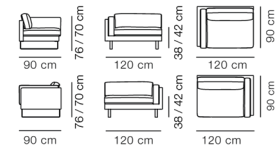

Order configuration

Legs: Round wooden legs in either oak soap, oak lacquer or oak smoke stained.

Round steel legs in either brushed chrome or black powder coating.

Metal frame in brushed chrome.

Fabric group 1	2.510
Fabric group 2	2.845
Fabric group 3	3.010
Fabric group 4	3.495
Fabric group 5	4.195
C.O.M. fabric	2.510

Fabric consumption: 5,4 m

Certifications

EN 1022:2005, EN 16139:2013 (L2)

Recommended upholstery

Fabric group 1	Grand Linen, Remix, Capture, Bardal, Re-wool, Linara, Natural Linen, Erik
Fabric group 2	Hallingdal, Barnum, Loop, Steelcut Trio, Fiord, Ruskin, Savoy
Fabric group 3	Divina Melange, Vidar, Sunniva, Foss, Clay
Fabric group 4	Cotil, Elle, Sisu, Safire
Fabric group 5	Grand Mohair, Gentle

Model 8057

EJ280 Elements End module, 2 seater 86, Arm L or R

Model details

1,1 m³ Packaging dimensions:
62 kg / L: 96 cm W: 65 cm H: 177 cm
57 kg



Designed by Erik Jørgensen Studio, 2018

End module for EJ280 Elements, including cushions and arm in one side. Available in fabric only. The external cover is non-removable. Please specify height and arm position left or right hand side, facing the sofa.

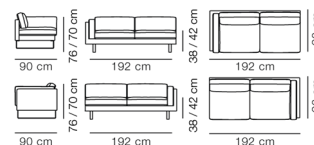

Order configuration

Legs: Round wooden legs in either oak soap, oak lacquer or oak smoke stained.

Round steel legs in either brushed chrome or black powder coating.

Metal frame in brushed chrome.

Fabric group 1	3.870
Fabric group 2	4.515
Fabric group 3	4.825
Fabric group 4	5.755
Fabric group 5	6.910
C.O.M. fabric	3.870

Fabric consumption: 8 m

Certifications

EN 1022:2005, EN 16139:2013 (L2)

Recommended upholstery

Fabric group 1	Grand Linen, Remix, Capture, Bardal, Re-wool, Linara, Natural Linen, Erik
Fabric group 2	Hallingdal, Barnum, Loop, Steelcut Trio, Fiord, Ruskin, Savoy
Fabric group 3	Divina Melange, Vidar, Sunniva, Foss, Clay
Fabric group 4	Cotil, Elle, Sisu, Safire
Fabric group 5	Grand Mohair, Gentle

Model 8067

EJ280 Elements End module, 2 seater 100, Arm L or R



Designed by Erik Jørgensen Studio, 2018

End module for EJ280 Elements, including cushions and arm in one side. Available in fabric only. The external cover is non-removable. Sledge legs in steel, or legs solid in wood or steel. Please specify height and arm position left or right hand side, facing the sofa.

Modeldetails

1,28 m³ Packaging dimensions:
68 kg / 62 kg L: 96 cm W: 65 cm H: 205 cm

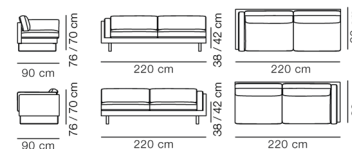

Order configuration

Legs: Round wooden legs in either oak soap, oak lacquer or oak smoke stained.

Round steel legs in either brushed chrome or black powder coating.

Metal frame in brushed chrome.

Fabric group 1	4.125
Fabric group 2	4.810
Fabric group 3	5.140
Fabric group 4	6.130
Fabric group 5	7.355
C.O.M. fabric	4.125

Fabric consumption: 8,8 m

Certifications

EN 1022:2005, EN 16139:2013 (L2)

Recommended upholstery

Fabric group 1	Grand Linen, Remix, Capture, Bardal, Re-wool, Linara, Natural Linen, Erik
Fabric group 2	Hallingdal, Barnum, Loop, Steelcut Trio, Fiord, Ruskin, Savoy
Fabric group 3	Divina Melange, Vidar, Sunniva, Foss, Clay
Fabric group 4	Cotil, Elle, Sisu, Safire
Fabric group 5	Grand Mohair, Gentle

EJ280 Elements - Overview

Model 809B, Configuration B
8057 L / 8099 / 8057 R

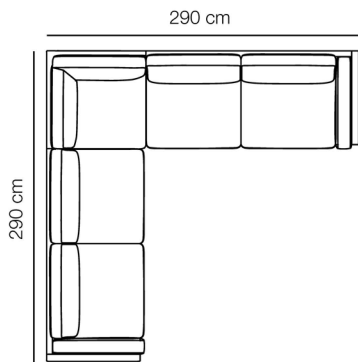

Model 809C, Configuration C
8067 L / 8099 / 8067 R

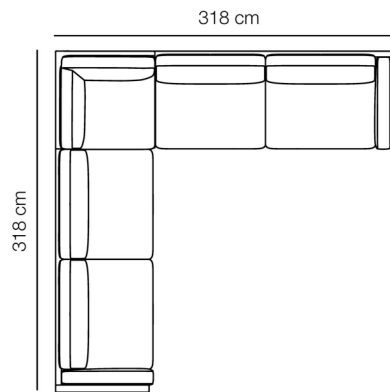

Model 809D, Configuration D
8066 L / 8099 / 8067 R

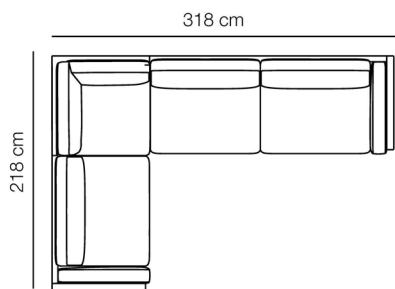



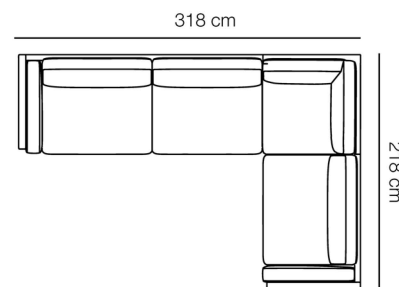









Model 809E, Configuration E
8067 L / 8099 / 8066 R



For customer's own configuration, please attach to the order a visual sketch of the desired layout

Erik Jørgensen Sofa Collection – Base options

Material	Type	Available for	
 Brushed chrome	 16,5 cm	EJ280 Sofa EJ280 Elements Base available in two heights	
 Black			 12,5 cm
 Black	 18 cm	EJ220 Sofa EJ280 Sofa EJ280 Elements	
 Brushed chrome			
 Smoked oak stained	 18 cm	EJ220 Sofa EJ280 Sofa EJ280 Elements	
 Oak lacquered			
 Oak soap			

Model 1522

EJ315 Sofa 2 seater



Designed by Erik Ole Jørgensen, 1975

Fully upholstered sofa with separate seat, back and arm cushions. Inner frame of wood. Available in fabric or leather. Covers are non-removable. Solid foam cushions. Arm cushions with Velcro fixing. Solid wood base.

Modeldetails

1,25 m³ Packaging dimensions:
55 kg / 45 kg L: 98 cm W: 82 cm H: 155 cm

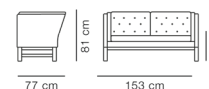

Essential Assortment

Item number	Upholstery	Legs	Price
15220020700003010300	Hallingdal 200	Oak soap treated	5.435
15220026800003010300	Hallingdal 116	Oak soap treated	5.435
15225130100003016400	Leather Omni 301, Black	Walnut oil treated	7.685
15225009500003010700	Leather Max 95, Cognac	Oak light oil	8.865

Essential variants only delivered with HR foam

Order configuration

	Oak soap	Oak oiled	Oak light oil	Walnut oiled
Fabric group 1	5.435	5.640	5.435	5.705
Fabric group 2	5.830	6.035	5.830	6.105
Fabric group 3	6.020	6.230	6.020	6.295
Fabric group 4	6.595	6.800	6.595	6.865
Fabric group 5	7.915	8.120	7.915	8.240
C.O.M. fabric	5.435	5.640	5.435	5.705
Leather group 1	7.705	7.910	7.705	7.975
Leather group 2	8.405	8.610	8.405	8.675
Leather group 3	9.490	9.695	9.490	9.760
Leather group 4	10.025	10.235	10.025	10.300
Leather group 5	11.530	11.740	11.530	11.845
C.O.M. leather	7.705	7.910	7.705	7.975

Fabric consumption: 6,5 m. Leather consumption: 15,5 m²

Extra charge for

Buttons in leather for furniture with fabric: +103

Recommended upholstery

Fabric group 1	Grand Linen, Remix, Capture, Bardal, Re-wool, Linara, Natural Linen, Erik
Fabric group 2	Hallingdal, Barnum, Loop, Steelcut Trio, Fiord, Ruskin, Savoy
Fabric group 3	Divina Melange, Vidar, Sunniva, Harald, Foss, Clay
Fabric group 4	Cotil, Elle, Sisu, Safire
Fabric group 5	Gentle
Leather group 1	Omni
Leather group 2	Primo, Trace
Leather group 3	Max
Leather group 4	Nubuck, Vegeta, Organic, Cera

Model 1542

EJ315 Sofa 2½ seater



Designed by Erik Ole Jørgensen, 1975

Fully upholstered sofa with separate seat, back and arm cushions. Inner frame of wood. Available in fabric or leather. Covers are non-removable. Solid foam cushions. Arm cushions with Velcro fixing. Solid wood base.

Modeldetails

1,47 m³ Packaging dimensions:
58 kg / 48 kg L: 98 cm W: 82 cm H: 183 cm

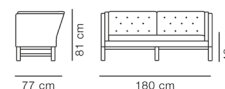

Essential Assortment

Item number	Upholstery	Legs	Price
15420020700003010300	Hallingdal 200	Oak soap treated	6.500
15420026800003010300	Hallingdal 116	Oak soap treated	6.500
15425130100003016400	Leather Omni 301, Black	Walnut oil treated	8.865
15425009500003010700	Leather Max 95, Cognac	Oak light oil	10.640

Essential variants only delivered with HR foam

Order configuration

	Oak soap	Oak oiled	Oak light oil	Walnut oiled
Fabric group 1	6.200	6.405	6.200	6.470
Fabric group 2	6.675	6.880	6.675	6.945
Fabric group 3	6.900	7.110	6.900	7.175
Fabric group 4	7.585	7.790	7.585	7.855
Fabric group 5	9.100	9.310	9.100	9.430
C.O.M. fabric	6.200	6.405	6.200	6.470
Leather group 1	8.905	9.115	8.905	9.180
Leather group 2	9.740	9.945	9.740	10.015
Leather group 3	11.035	11.240	11.035	11.305
Leather group 4	11.675	11.885	11.675	11.950
Leather group 5	13.430	13.635	13.430	13.740
C.O.M. leather	8.905	9.115	8.905	9.180

Fabric consumption: 7,8 m. Leather consumption: 18,5 m²

Extra charge for

Buttons in leather for furniture with fabric: +103

Recommended upholstery

Fabric group 1	Grand Linen, Remix, Capture, Bardal, Re-wool, Linara, Natural Linen, Erik
Fabric group 2	Hallingdal, Barnum, Loop, Steelcut Trio, Fiord, Ruskin, Savoy
Fabric group 3	Divina Melange, Vidar, Sunniva, Harald, Foss, Clay
Fabric group 4	Cotil, Elle, Sisu, Safire
Fabric group 5	Gentle
Leather group 1	Omni
Leather group 2	Primo, Trace
Leather group 3	Max
Leather group 4	Nubuck, Vegeta, Organic, Cera

Model 1523

EJ315 Sofa 3 seater



Designed by Erik Ole Jørgensen, 1975

Fully upholstered sofa with separate seat, back and arm cushions. Inner frame of wood. Available in fabric or leather. Covers are non-removable. Solid foam cushions. Arm cushions with Velcro fixing. Solid wood base.

Modeldetails

1,7 m³ Packaging dimensions:
72 kg / 62 kg L: 98 cm W: 82 cm H: 212 cm

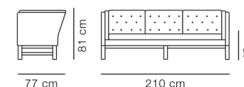

Essential Assortment

Item number	Upholstery	Legs	Price
15230020700003010300	Hallingdal 200	Oak soap treated	6.855
15230026800003010300	Hallingdal 116	Oak soap treated	6.855
15235130100003016400	Leather Omni 301, Black	Walnut oil treated	9.455
15235009500003010700	Leather Max 95, Cognac	Oak light oil	11.350

Essential variants only delivered with HR foam

Order configuration

	Oak soap	Oak oiled	Oak light oil	Walnut oiled
Fabric group 1	6.675	6.885	6.675	6.950
Fabric group 2	7.195	7.405	7.195	7.470
Fabric group 3	7.445	7.655	7.445	7.720
Fabric group 4	8.195	8.400	8.195	8.470
Fabric group 5	9.835	10.040	9.835	10.160
C.O.M. fabric	6.675	6.885	6.675	6.950
Leather group 1	9.645	9.855	9.645	9.920
Leather group 2	10.560	10.765	10.560	10.830
Leather group 3	11.980	12.185	11.980	12.250
Leather group 4	12.685	12.890	12.685	12.955
Leather group 5	14.585	14.795	14.585	14.900
C.O.M. leather	9.645	9.855	9.645	9.920

Fabric consumption: 8,5 m. Leather consumption: 19,9 m²

Extra charge for

Buttons in leather for furniture with fabric: +103

Recommended upholstery

Fabric group 1	Grand Linen, Remix, Capture, Bardal, Re-wool, Linara, Natural Linen, Erik
Fabric group 2	Hallingdal, Barnum, Loop, Steelcut Trio, Fiord, Ruskin, Savoy
Fabric group 3	Divina Melange, Vidar, Sunniva, Harald, Foss, Clay
Fabric group 4	Cotil, Elle, Sisu, Safire
Fabric group 5	Gentle
Leather group 1	Omni
Leather group 2	Primo, Trace
Leather group 3	Max
Leather group 4	Nubuck, Vegeta, Organic, Cera

Model 5722

Gomo Sofa 2-pers.



Designed by Hugo Passos, 2023

Fully upholstered sofa. Inner construction consists of a wooden shell in moulded plywood and furniture board and seat supported with webbing. Upholstered in HR or CMHR foam and cover in fabric or leather. Fabric cover is removable. Fixed base where chair is mounted with plastic legs with reversible glides in plastic which can be changed to felt.

Modeldetails

0,88 m³ Packaging dimensions:
44 kg / 30 kg L: 151 cm W: 76 cm H: 77 cm

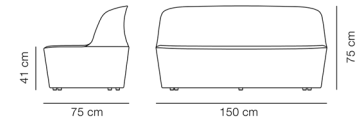

Essential Assortment

Item number	Upholstery	Price
5722193000005503271	Re-Wool 198	2.715
57221931100005503271	Re-Wool 128	2.715

Essential variants are delivered with plastic glides and HR foam

Order configuration

Fabric group 0	2.490
Fabric group 1	2.800
Fabric group 2	3.025
Fabric group 3	3.240
Fabric group 4	3.625
Fabric group 5	4.335
C.O.M. fabric	2.800
Leather group 0	3.870
Leather group 1	4.420
Leather group 2	4.940
Leather group 3	5.620
Leather group 4	6.760
Leather group 5	8.730
C.O.M. leather	4.420
Sheepskin	5.630

Fabric consumption: 3,6 m. Leather consumption: 10,9 m²

When upholstered in velvet the stitching will not be visible.

Certifications

FSC® certified

EU Ecolabel variants: HR foam and upholstery in Connect, Remix, Re-wool, Steelcut Quartet, Vidar, Tonus or Wave fabric

ANSI/BIFMA X5.4-2020

Recommended upholstery

Fabric group 0	Connect
Fabric group 1	Grand Linen, Capture, Re-wool, Bardal, Linara, Remix, Erik
Fabric group 2	Hallingdal, Barnum, Steelcut Trio, Ruskin, Fiord, Loop
Fabric group 3	Foss, Sunniva, Divina Melange, Vidar, Clay
Fabric group 4	Safire, Sisú, Elle
Fabric group 5	Gentle
Leather group 0	Vice
Leather group 1	Omni
Leather group 2	Primo, Trace
Leather group 3	Max
Leather group 4	Vegeta, Nubuck, Organic

Model P5722

Gomo Accessories Cover for Gomo sofa

Designed by Hugo Passos, 2023

Loose cover for re-upholstery of Gomo Sofa. Please note there will not be visible stitching in velour textiles.
Professional assistance is recommended.

Order configuration

Fabric group 0	745
Fabric group 1	840
Fabric group 2	905
Fabric group 3	970
Fabric group 4	1.085
Fabric group 5	1.300
C.O.M. fabric	840

Fabric consumption: 3,6 m

Recommended upholstery

Fabric group 0	Connect
Fabric group 1	Grand Linen, Capture, Re-wool, Bardal, Linara, Remix, Erik
Fabric group 2	Hallingdal, Barnum, Steelcut Trio, Ruskin, Fiord, Loop
Fabric group 3	Foss, Sunniva, Divina Melange, Vidar, Clay
Fabric group 4	Safire, Sisu, Cotil, Elle
Fabric group 5	Gentle

Model 6522

JG Sofa 2 seater



Designed by Jørgen Gammelgaard, 1979

Fully upholstered sofa with piping on cushions. Separate seat and back cushions. Inner frame of wood. Available in fabric or leather. Cushions in foam core with down wrap and removable covers. External frame cover is non-removable. Legs of solid wood or steel screwed into the frame. Oak legs available with natural leather band and brushed steel available with a knurled detail.

Model details

0,86 m³ Packaging dimensions:
57 kg / 50 kg L: 82 cm W: 73 cm H: 144 cm

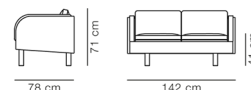

Essential Assortment

Item number	Upholstery	Legs	Price
652219311010700	Re-Wool 128	Oak light oil	4.345
652244807016400	Grand Linen Naturel 0024	Walnut oil treated	4.345
652251301060100	Leather Omni 301, Black	Stainless steel, brushed	5.955
652250090011700	Leather Vegeta 90, Natural	Oak light oil / natural leather strap	9.060

Essential variants only delivered with HR foam

Order configuration

	Oak light oil	Oak light oil with natural leather strap	Walnut oil	Brushed stainless steel	Brushed steel, Knurled
Fabric group 0	4.315	4.315	4.315	4.315	4.315
Fabric group 1	4.635	4.635	4.635	4.635	4.635
Fabric group 2	5.265	5.265	5.265	5.265	5.265
Fabric group 3	5.895	5.895	5.895	5.895	5.895
Fabric group 4	6.940	6.940	6.940	6.940	6.940
Fabric group 5	8.425	8.425	8.425	8.425	8.425
C.O.M. fabric	4.635	4.635	4.635	4.635	4.635
Leather group 0	5.610	5.610	5.610	5.610	5.610
Leather group 1	6.460	6.460	6.460	6.460	6.460
Leather group 2	7.600	7.600	7.600	7.600	7.600
Leather group 3	8.740	8.740	8.740	8.740	8.740
Leather group 4	9.875	9.875	9.875	9.875	9.875
Leather group 5	12.150	12.150	12.150	12.150	12.150
C.O.M. leather	6.460	6.460	6.460	6.460	6.460

Fabric consumption: 8,5 m. Leather consumption: 17 m²

Recommended upholstery

Fabric group 0	Connect
Fabric group 1	Grand Linen, Capture, Bardal, Re-wool, Linara, Natural Linen, Erik
Fabric group 2	Hallingdal, Barnum, Loop, Steelcut Trio, Fiord, Ruskin
Fabric group 3	Divina Melange, Vidar, Sunniva, Harald, Foss, Clay
Fabric group 4	Cotil, Elle, Sisu, Safire
Fabric group 5	Gentle
Leather group 0	Vice
Leather group 1	Omni
Leather group 2	Primo, Trace
Leather group 3	Max
Leather group 4	Nubuck, Vegeta, Organic

Model 6523

JG Sofa 3 seater



Designed by Jørgen Gammelgaard, 1979

Fully upholstered sofa with piping on cushions. Separate seat and back cushions. Inner frame of wood. Available in fabric or leather. Cushions in foam core with down wrap and removable covers. External frame cover is non-removable. Legs of solid wood or steel screwed into the frame. Oak legs available with natural leather band and brushed steel available with a knurled detail.

Model details

1,22 m³ Packaging dimensions:
77 kg / 70 kg L: 82 cm W: 73 cm H: 204 cm

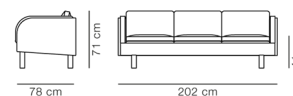

Essential Assortment

Item number	Upholstery	Legs	Price
652319311010700	Re-Wool 128	Oak light oil	4.965
652344807016400	Grand Linen Naturel 0024	Walnut oil treated	4.965
652351301060100	Leather Omni 301, Black	Stainless steel, brushed	6.455
652350090011700	Leather Vegeta 90, Natural	Oak light oil / natural leather strap	9.680

Essential variants only delivered with HR foam

Order configuration

	Oak light oil	Oak light oil with natural leather strap	Walnut oil	Brushed stainless steel	Brushed steel, Knurled
Fabric group 0	4.985	4.985	4.985	4.985	4.985
Fabric group 1	5.300	5.300	5.300	5.300	5.300
Fabric group 2	5.930	5.930	5.930	5.930	5.930
Fabric group 3	6.565	6.565	6.565	6.565	6.565
Fabric group 4	7.605	7.605	7.605	7.605	7.605
Fabric group 5	9.090	9.090	9.090	9.090	9.090
C.O.M. fabric	5.300	5.300	5.300	5.300	5.300
Leather group 0	6.275	6.275	6.275	6.275	6.275
Leather group 1	7.130	7.130	7.130	7.130	7.130
Leather group 2	8.265	8.265	8.265	8.265	8.265
Leather group 3	9.405	9.405	9.405	9.405	9.405
Leather group 4	10.540	10.540	10.540	10.540	10.540
Leather group 5	12.815	12.815	12.815	12.815	12.815
C.O.M. leather	7.130	7.130	7.130	7.130	7.130

Fabric consumption: 10 m. Leather consumption: 20 m²

Recommended upholstery

Fabric group 0	Connect
Fabric group 1	Grand Linen, Capture, Bardal, Re-wool, Linara, Natural Linen, Erik
Fabric group 2	Hallingdal, Barnum, Loop, Steelcut Trio, Fiord, Ruskin
Fabric group 3	Divina Melange, Vidar, Sunniva, Harald, Foss, Clay
Fabric group 4	Cotil, Elle, Sisu, Safire
Fabric group 5	Gentle
Leather group 0	Vice
Leather group 1	Omni
Leather group 2	Primo, Trace
Leather group 3	Max
Leather group 4	Nubuck, Vegeta, Organic

Model 2712

Jota sofa 2 seater, 185 cm



Designed by Jasper Morrison, 2024

Fully upholstered sofa with internal frame of wood and seat supported with supportive webbing. Available with cover in fabric where arm, seat and back cushions are removable covers while cover on frame is fixed. Cushions are with down and foam granulate mix in separate chambers, in addition seat cushion is made with a foam core. Cover is done with piping on gables and french stitching details on cushions. Mounted with oak legs.

Modeldetails

1,54 m³ Packaging dimensions:
76 kg / L: 99 cm W: 82 cm H: 190 cm
66 kg

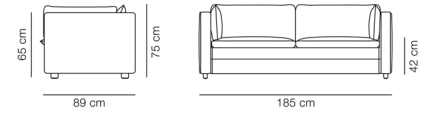

Order configuration

Legs: wooden legs in either Oak light oil, Oak lacquered or oak black lacquered.

	Excl. arm cushions	Incl. arm cushions
Fabric group 1	4.135	4.700
Fabric group 2	4.580	5.255
Fabric group 3	5.005	5.780
Fabric group 4	5.640	6.575
Fabric group 5	7.170	8.475
C.O.M. fabric	4.135	4.700

Fabric consumption inkl. arm cushions: 10 m
Fabric consumption excl. arm cushions: 8,3 m

Delivery from February 2025

Certifications

FSC® certified

Recommended upholstery

Fabric group 1	Bardal, Capture, Re-wool
Fabric group 2	Barnum, Steelcut Trio, Fiord, Ruskin, Loop
Fabric group 3	Vidar, Clay, Divina Melange
Fabric group 4	Sisu, Elle, Safire

Model 2713

Jota sofa 3 seater, 231 cm



Designed by Jasper Morrison, 2024

Fully upholstered sofa with internal frame of wood and seat supported with supportive webbing. Available with cover in fabric where arm, seat and back cushions are removable covers while cover on frame is fixed. Cushions are with down and foam granulate mix in separate chambers, in addition seat cushion is made with a foam core. Cover is done with piping on gables and french stitching details on cushions. Mounted with oak legs.

Modeldetails

1,93 m³ Packaging dimensions:
89 kg / L: 99 cm W: 82 cm H: 237 cm
79 kg

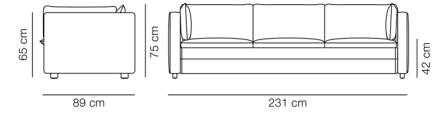

Order configuration

Legs: wooden legs in either Oak light oil, Oak lacquered or oak black lacquered.

	Excl. arm cushions	Incl. arm cushions
Fabric group 1	4.610	5.240
Fabric group 2	5.020	5.855
Fabric group 3	5.415	6.445
Fabric group 4	6.010	7.330
Fabric group 5	7.430	9.460
C.O.M. fabric	4.610	5.240

Fabric consumption inkl. arm cushions: 12 m
Fabric consumption excl. arm cushions: 10,3 m

Delivery from February 2025

Certifications

FSC® certified

Recommended upholstery

Fabric group 1	Bardal, Capture, Re-wool
Fabric group 2	Barnum, Steelcut Trio, Fiord, Ruskin, Loop
Fabric group 3	Vidar, Clay, Divina Melange
Fabric group 4	Sisu, Elle, Safire

Model P2711

Decorative cushion



Designed by Jasper Morrison, 2024

Decorative cushion with french stitching details for Jota. Down and foam granulate mix filling. Removable cover in fabric.

Modeldetails

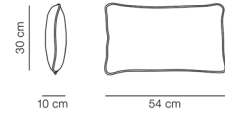

Order configuration

Fabric group 1	125
Fabric group 2	150
Fabric group 3	170
Fabric group 4	205
Fabric group 5	290
C.O.M. fabric	125

Fabric consumption: 0,65 m

Delivery from February 2025

Recommended upholstery

Fabric group 1	Bardal, Capture, Re-wool
Fabric group 2	Barnum, Steelcut Trio, Fiord, Ruskin, Loop
Fabric group 3	Vidar, Clay, Divina Melange
Fabric group 4	Sisu, Elle, Safire

Model 4952

Konami Sofa 2 seater



Designed by Damian Williamson, 2019

Fully upholstered sofa. Inner frame of wood with cold cured foam. Cushions are fixed to the body of the sofa. Available in a limited selection of fabrics only. All covers are non-removable. Powder coated steel or brushed stainless steel base.

Modeldetails

3,1 m³ Packaging dimensions:
185 kg / 71,4 kg L: 287 cm W: 112 cm H: 96 cm

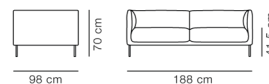

Essential Assortment

Item number	Upholstery	Legs	Price
49520167014098400000	Loop 36	Black	6.695
49520167214098601000	Loop 32	Stainless steel, brushed	6.695
49520167314098400000	Loop 42	Black	6.695
49524070714098400000	Sisu 0105	Black	7.670
49524070814098601000	Sisu 0125	Stainless steel, brushed	7.670

Essential variants only delivered with HR foam

Order configuration

	Black	Brushed stainless steel
Fabric group 1	6.370	6.370
Fabric group 2	6.950	6.950
Fabric group 3	7.225	7.225
Fabric group 4	8.055	8.055
Fabric group 5	9.670	9.670
C.O.M. fabric	6.370	6.370

Fabric consumption: 7,5 m

Only available in selected fabrics.

Note - Complementary cushions are ordered separately (P4900).

Recommended upholstery

Fabric group 1	Bardal, Re-wool
Fabric group 2	Hallingdal, Barnum, Loop
Fabric group 3	Vidar, Clay, Divina Melange
Fabric group 4	Sisu, Elle, Safire
Fabric group 5	Gentle

Model 4962

Konami Sofa 2 seater



Designed by Damian Williamson, 2019

Fully upholstered sofa. Inner frame of wood with cold cured foam. Cushions are fixed to the body of the sofa. Available in a limited selection of fabrics only. All covers are non-removable. Powder coated steel or brushed stainless steel base.

Modeldetails

3,1 m³ Packaging dimensions:
194 kg / 90 kg L: 287 cm W: 112 cm H: 96 cm

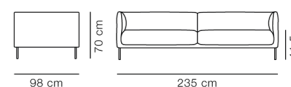

Essential Assortment

Item number	Upholstery	Legs	Price
49620167014098400000	Loop 36	Black	7.305
49620167214098601000	Loop 32	Stainless steel, brushed	7.305
49620167314098400000	Loop 42	Black	7.305
49624070714098400000	Sisu 0105	Black	8.280
49624070814098601000	Sisu 0125	Stainless steel, brushed	8.280

Essential variants only delivered with HR foam

Order configuration

	Black	Brushed stainless steel
Fabric group 1	7.075	7.075
Fabric group 2	7.730	7.730
Fabric group 3	8.045	8.045
Fabric group 4	8.990	8.990
Fabric group 5	10.785	10.785
C.O.M. fabric	7.075	7.075

Fabric consumption: 7,5 m

Only available in selected fabrics.

Note - Complementary cushions are ordered separately (P4900).

Recommended upholstery

Fabric group 1	Bardal, Re-wool
Fabric group 2	Hallingdal, Barnum, Loop
Fabric group 3	Vidar, Clay, Divina Melange
Fabric group 4	Sisu, Elle, Safire
Fabric group 5	Gentle

Model 4953

Konami Sofa 2 seater



Designed by Damian Williamson, 2019

Fully upholstered sofa. Inner frame of wood with cold cured foam. Cushions are fixed to the body of the sofa. Available in a limited selection of fabrics only. All covers are non-removable. Powder coated steel or brushed stainless steel base.

Modeldetails

3,1 m³ Packaging dimensions:
214 kg / 110 kg L: 287 cm W: 112 cm H: 96 cm

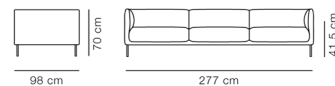

Essential Assortment

Item number	Upholstery	Legs	Price
49530167014098400000	Loop 36	Black	7.670
49530167214098601000	Loop 32	Stainless steel, brushed	7.670
49530167314098400000	Loop 42	Black	7.670
49534070714098400000	Sisu 0105	Black	9.740
49534070814098601000	Sisu 0125	Stainless steel, brushed	9.740

Essential variants only delivered with HR foam

Order configuration

	Black	Brushed stainless steel
Fabric group 1	8.305	8.305
Fabric group 2	9.040	9.040
Fabric group 3	9.390	9.390
Fabric group 4	10.445	10.445
Fabric group 5	12.530	12.530
C.O.M. fabric	8.305	8.305

Fabric consumption: 9,5 m

Only available in selected fabrics.

Note - Complementary cushions are ordered separately (P4900).

Recommended upholstery

Fabric group 1	Bardal, Re-wool
Fabric group 2	Hallingdal, Barnum, Loop
Fabric group 3	Vidar, Clay, Divina Melange
Fabric group 4	Sisu, Elle, Safire
Fabric group 5	Gentle

Model P4900

Konami / Nami Accessories Decorative cushion



Designed by Damian Williamson, 2019

Decorative cushion for Konami og Nami Sofa. Down and foam granulate filling.
Removable cover in fabric.

Order configuration

Fabric group 1	310
Fabric group 2	350
Fabric group 3	380
Fabric group 4	425
Fabric group 5	530
C.O.M. fabric	310

Fabric consumption: 0,55 m

Cushion: 50 x 50 cm.

Recommended upholstery

Fabric group 1	Bardal, Re-wool
Fabric group 2	Hallingdal, Barnum, Loop
Fabric group 3	Vidar, Clay, Divina Melange
Fabric group 4	Sisu, Elle, Safire
Fabric group 5	Gentle

Model 2208

Mogensen 2208 Sofa 2 seater



Designed by Børge Mogensen, 1963

Fully upholstered sofa with piping in all stitches. Available in leather or fabric. Fixed legs of solid wood, built into the wood internal frame. Seat is supported with jute and rubber band webbing. Separate seat and back cushions with removable covers. Please specify cushion type. Cushions are either with foam core with down wrap or filled with a foam and down mix in separate chambers

Modeldetails

1,94 m³ Packaging dimensions:
103 kg / 37 kg L: 192 cm W: 97 cm H: 104 cm

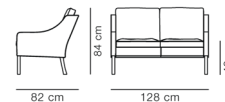

Order configuration

	Oak soap	Oak oiled	Oak light oil	Oak black lacquered	Walnut oiled
Fabric group 1	6.771	6.771	6.771	6.771	6.771
Fabric group 2	7.201	7.201	7.201	7.201	7.201
Fabric group 3	7.616	7.616	7.616	7.616	7.616
Fabric group 4	8.236	8.236	8.236	8.236	8.236
Fabric group 5	9.686	9.686	9.686	9.686	9.686
Leather group 2	8.721	8.721	8.721	8.721	8.721
Leather group 3	9.721	9.721	9.721	9.721	9.721
Leather group 4	11.076	11.076	11.076	11.076	11.076
Leather group 5	12.911	12.911	12.911	12.911	12.911

Fabric consumption: 7,65 m. Leather consumption: 12,77 m²

Recommended upholstery

Fabric group 1	Bardal, Linara, Capture, Remix, Re-wool, Grand Linen, Erik
Fabric group 2	Hallingdal, Fiord, Ruskin, Savoy, Barnum, Steelcut Trio, Loop
Fabric group 3	Divina Melange, Vidar, Sunniva, Clay, Foss
Fabric group 4	Sisu, Safire
Fabric group 5	Gentle
Leather group 2	Primo, Trace
Leather group 3	Max
Leather group 4	Vegeta, Nubuck, Organic, Cera

Model 2209

Mogensen 2209 Sofa 3 seater



Designed by Børge Mogensen, 1963

Fully upholstered sofa with piping in all stitches. Available in leather or fabric. Fixed legs of solid wood, built into the wood internal frame. Seat is supported with jute and rubber band webbing. Separate seat and back cushions with removable covers. Please specify cushion type. Cushions are either with foam core with down wrap or filled with a foam and down mix in separate chambers

Modeldetails

2,4 m³ Packaging dimensions:
129 kg / 45 kg L: 245 cm W: 96 cm H: 102 cm

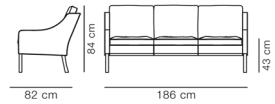

Order configuration

	Oak soap	Oak oiled	Oak light oil	Oak black lacquered	Walnut oiled
Fabric group 1	8.505	8.505	8.505	8.505	8.505
Fabric group 2	9.075	9.075	9.075	9.075	9.075
Fabric group 3	9.625	9.625	9.625	9.625	9.625
Fabric group 4	10.445	10.445	10.445	10.445	10.445
Fabric group 5	12.370	12.370	12.370	12.370	12.370
Leather group 2	10.900	10.900	10.900	10.900	10.900
Leather group 3	12.185	12.185	12.185	12.185	12.185
Leather group 4	13.825	13.825	13.825	13.825	13.825
Leather group 5	16.435	16.435	16.435	16.435	16.435

Fabric consumption: 10 m. Leather consumption: 16,26 m²

Recommended upholstery

Fabric group 1	Bardal, Linara, Capture, Remix, Re-wool, Grand Linen, Erik
Fabric group 2	Hallingdal, Fiord, Ruskin, Savoy, Barnum, Steelcut Trio, Loop
Fabric group 3	Divina Melange, Vidar, Sunniva, Clay, Foss
Fabric group 4	Sisu, Safire
Fabric group 5	Gentle
Leather group 2	Primo, Trace
Leather group 3	Max
Leather group 4	Vegeta, Nubuck, Organic, Cera

Model 2212

Mogensen 2212 Sofa 2 seater



Designed by Børge Mogensen, 1962

Fully upholstered sofa with piping in all stitches. Available in leather or fabric. Fixed legs of solid wood, built into the wood internal frame. Seat is supported with jute and rubber band webbing. Separate seat, back and arm cushions with removable covers. Please specify cushion type. Cushions are either with foam core with down wrap or filled with a foam and down mix in separate chambers

Modeldetails

1,94 m³ Packaging dimensions:
119 kg / 53 kg L: 192 cm W: 97 cm H: 104 cm

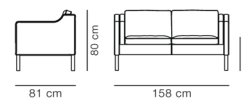

Essential Assortment

Item number	Upholstery	Wood	Price
22121035009010	Leather Vegeta 90, Natural	Oak soap	11.820
22121075084110	Leather Cera 905, Russet brown	Oak light oil	11.820

Essential variants only delivered with HR foam

Order configuration

	Oak soap	Oak oiled	Oak light oil	Oak black lacquered	Walnut oiled
Fabric group 1	7.991	7.991	7.991	7.991	7.991
Fabric group 2	8.526	8.526	8.526	8.526	8.526
Fabric group 3	9.046	9.046	9.046	9.046	9.046
Fabric group 4	9.821	9.821	9.821	9.821	9.821
Fabric group 5	11.641	11.641	11.641	11.641	11.641
Leather group 2	10.081	10.081	10.081	10.081	10.081
Leather group 3	11.211	11.211	11.211	11.211	11.211
Leather group 4	12.746	12.746	12.746	12.746	12.746
Leather group 5	15.416	15.416	15.416	15.416	15.416

Fabric consumption: 11,5 m. Leather consumption: 17,42 m²

Recommended upholstery

Fabric group 1	Bardal, Linara, Capture, Remix, Re-wool, Grand Linen, Erik
Fabric group 2	Hallingdal, Fiord, Ruskin, Savoy, Barnum, Steelcut Trio, Loop
Fabric group 3	Divina Melange, Vidar, Sunniva, Clay, Foss
Fabric group 4	Sisu, Safire
Fabric group 5	Gentle
Leather group 2	Primo, Trace
Leather group 3	Max
Leather group 4	Vegeta, Nubuck, Organic, Cera

Model 2213

Mogensen 2213 Sofa 3 seater



Designed by Børge Mogensen, 1962

Fully upholstered sofa with piping in all stitches. Available in leather or fabric. Fixed legs of solid wood, built into the wood internal frame. Seat is supported with jute and rubber band webbing. Separate seat, back and arm cushions with removable covers. Please specify cushion type. Cushions are either with foam core with down wrap or filled with a foam and down mix in separate chambers

Modeldetails

2,4 m³ Packaging dimensions:
157 kg / 73 kg L: 245 cm W: 96 cm H: 102 cm

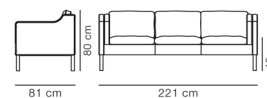

Essential Assortment

Item number	Upholstery	Wood	Price
22131035009010	Leather Vegeta 90, Natural	Oak soap	15.960
22131075084110	Leather Cera 905, Russet brown	Oak light oil	15.960

Essential variants only delivered with HR foam

Order configuration

	Oak soap	Oak oiled	Oak light oil	Oak black lacquered	Walnut oiled
Fabric group 1	9.801	9.801	9.801	9.801	9.801
Fabric group 2	10.516	10.516	10.516	10.516	10.516
Fabric group 3	11.196	11.196	11.196	11.196	11.196
Fabric group 4	12.226	12.226	12.226	12.226	12.226
Fabric group 5	14.641	14.641	14.641	14.641	14.641
Leather group 2	12.941	12.941	12.941	12.941	12.941
Leather group 3	14.586	14.586	14.586	14.586	14.586
Leather group 4	16.726	16.726	16.726	16.726	16.726
Leather group 5	20.196	20.196	20.196	20.196	20.196

Fabric consumption: 12,5 m. Leather consumption: 20,9 m²

Recommended upholstery

Fabric group 1	Bardal, Linara, Capture, Remix, Re-wool, Grand Linen, Erik
Fabric group 2	Hallingdal, Fiord, Ruskin, Savoy, Barnum, Steelcut Trio, Loop
Fabric group 3	Divina Melange, Vidar, Sunniva, Clay, Foss
Fabric group 4	Sisu, Safire
Fabric group 5	Gentle
Leather group 2	Primo, Trace
Leather group 3	Max
Leather group 4	Vegeta, Nubuck, Organic, Cera

Model 2292

Mogensen Coupé Sofa 2 seater



Designed by Børge Mogensen, 1971

Fully upholstered sofa with piping in all stitches. Available in leather or fabric. Fixed legs of solid wood, built into the wood internal frame. Seat is supported with jute and rubber band webbing. Separate seat, back and arm cushions with removable covers. Please specify cushion type. Cushions are either with foam core with down wrap or filled with a foam and down mix in separate chambers

Modeldetails

1,95 m³ Packaging dimensions:
143 kg / 65 kg L: 165 cm W: 96 cm H: 124 cm

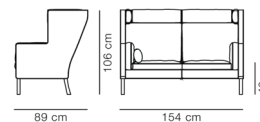

Essential Assortment

Item number	Upholstery	Wood	Price
2292103500901001	Leather Vegeta 90, Natural	Oak soap	18.325
2292107508411001	Leather Cera 905, Russet brown	Oak light oil	18.325

Essential variants only delivered with HR foam

Order configuration

	Oak soap	Oak oiled	Oak light oil	Oak black lacquered	Walnut oiled
Fabric group 1	9.340	9.340	9.340	9.340	9.340
Fabric group 2	10.200	10.200	10.200	10.200	10.200
Fabric group 3	11.025	11.025	11.025	11.025	11.025
Fabric group 4	12.265	12.265	12.265	12.265	12.265
Fabric group 5	15.235	15.235	15.235	15.235	15.235
Leather group 2	13.845	13.845	13.845	13.845	13.845
Leather group 3	16.045	16.045	16.045	16.045	16.045
Leather group 4	18.745	18.745	18.745	18.745	18.745
Leather group 5	22.025	22.025	22.025	22.025	22.025

Fabric consumption: 14,1 m. Leather consumption: 26,13 m²

Incl. 1 cushion.

Recommended upholstery

Fabric group 1	Bardal, Linara, Capture, Remix, Re-wool, Grand Linen, Erik
Fabric group 2	Hallingdal, Fiord, Ruskin, Savoy, Barnum, Steelcut Trio, Loop
Fabric group 3	Divina Melange, Vidar, Sunniva, Clay, Foss
Fabric group 4	Sisu, Safire
Fabric group 5	Gentle
Leather group 2	Primo, Trace
Leather group 3	Max
Leather group 4	Vegeta, Nubuck, Organic, Cera

Model 2202

Mogensen Ottoman



Designed by Børge Mogensen, 1963

Fully upholstered ottoman with piping in all stitches. Available in leather or fabric. Fixed legs of solid wood, built into the wood internal frame. Seat is supported with polyamide webbing. Separate seat cushion with removable cover. Please specify cushion type. Cushions are either with foam core with down wrap or filled with a foam and down mix in separate chambers

Model details

0,2 m³ Packaging dimensions:
11 kg / 9 kg L: 60 cm W: 60 cm H: 55 cm

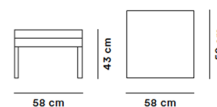

Essential Assortment

Item number	Upholstery	Wood	Price
22021035009010	Leather Vegeta 90, Natural	Oak soap	2.360
22021075084110	Leather Cera 905, Russet brown	Oak light oil	2.360

Essential variants only delivered with HR foam

Order configuration

	Oak soap	Oak oiled	Oak light oil	Oak black lacquered	Walnut oiled
Fabric group 1	1.825	1.825	1.825	1.825	1.825
Fabric group 2	1.970	1.970	1.970	1.970	1.970
Fabric group 3	2.105	2.105	2.105	2.105	2.105
Fabric group 4	2.310	2.310	2.310	2.310	2.310
Fabric group 5	2.760	2.760	2.760	2.760	2.760
Leather group 2	2.175	2.175	2.175	2.175	2.175
Leather group 3	2.420	2.420	2.420	2.420	2.420
Leather group 4	2.650	2.650	2.650	2.650	2.650
Leather group 5	3.040	3.040	3.040	3.040	3.040

Fabric consumption: 2,5 m. Leather consumption: 3,13 m²

Recommended upholstery

Fabric group 1	Bardal, Linara, Capture, Remix, Re-wool, Grand Linen, Erik
Fabric group 2	Hallingdal, Fiord, Ruskin, Savoy, Barnum, Steelcut Trio, Loop
Fabric group 3	Divina Melange, Vidar, Sunniva, Clay, Foss
Fabric group 4	Sisu, Safire
Fabric group 5	Gentle
Leather group 2	Primo, Trace
Leather group 3	Max
Leather group 4	Vegeta, Nubuck, Organic, Cera

Model 2333

Mogensen 2333 Sofa 3 seater



Designed by Børge Mogensen, 1971

Fully upholstered sofa, available in leather or fabric. Fixed legs of solid wood, built into the wood internal frame. Seat is supported with polyamide webbing. Separate seat, back and arm cushions with removable covers. Cushions has foam core with down wrap. Leather sofas has piping in all stitches and fabric sofas are made with double stitch.

Modeldetails

2,4 m³ Packaging dimensions:
152 kg / 68 kg L: 245 cm W: 96 cm H: 102 cm

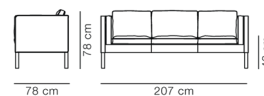

Order configuration

	Oak light oil	Oak black lacquered
Fabric group 1	6.970	6.970
Fabric group 2	7.320	7.320
Fabric group 3	7.960	7.960
Fabric group 4	8.435	8.435
Fabric group 5	10.125	10.125
C.O.M. fabric	6.970	6.970
Leather group 1	10.915	10.915
Leather group 2	12.320	12.320
Leather group 3	13.775	13.775
Leather group 4	15.155	15.155
Leather group 5	17.430	17.430
C.O.M. leather	10.915	10.915

Fabric consumption: 11 m. Leather consumption: 20,9 m²

The sofa is delivered without piping, when upholstered in fabric.

Extra charge for

Fabric or leather piping for furniture with fabric: +655
Oak lacquered, oak soap, oak oiled or stained legs: +353

Recommended upholstery

Fabric group 1 Remix, Bardal, Re-wool, Linara, Capture, Grand Linen, Erik
Fabric group 2 Hallingdal, Loop, Steelcut Trio, Fiord, Ruskin, Barnum
Fabric group 3 Divina Melange, Vidar, Sunniva, Foss, Clay
Fabric group 4 Sisu, Elle, Safire
Fabric group 5 Gentle
Leather group 1 Omni
Leather group 2 Primo, Trace
Leather group 3 Max
Leather group 4 Nubuck, Organic, Vegeta, Cera

Model 2335

Mogensen 2335 Sofa 2½ seater



Designed by Børge Mogensen, 1996

Fully upholstered sofa, available in leather or fabric. Fixed legs of solid wood, built into the wood internal frame. Seat is supported with polyamide webbing. Separate seat, back and arm cushions with removable covers. Cushions has foam core with down wrap. Leather sofas has piping in all stitches, fabric sofas are made with double stitch.

Modeldetails

1,94 m³ Packaging dimensions:
126 kg / 60 kg L: 192 cm W: 97 cm H: 104 cm

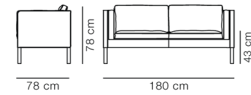

Order configuration

	Oak light oil	Oak black lacquered
Fabric group 1	6.555	6.555
Fabric group 2	6.885	6.885
Fabric group 3	7.560	7.560
Fabric group 4	8.025	8.025
Fabric group 5	9.630	9.630
C.O.M. fabric	6.555	6.555
Leather group 1	9.805	9.805
Leather group 2	11.235	11.235
Leather group 3	12.805	12.805
Leather group 4	14.085	14.085
Leather group 5	16.200	16.200
C.O.M. leather	9.805	9.805

Fabric consumption: 10,5 m. Leather consumption: 20,07 m²

Design: Børge Mogensen Studio

The sofa is delivered without piping, when upholstered in fabric.

Extra charge for

Fabric or leather piping for furniture with fabric: +553
Oak lacquered, oak soap, oak oiled or stained legs: +353

Recommended upholstery

Fabric group 1 Remix, Bardal, Re-wool, Linara, Capture, Grand Linen, Erik
Fabric group 2 Hallingdal, Loop, Steelcut Trio, Fiord, Ruskin, Barnum
Fabric group 3 Divina Melange, Vidar, Sunniva, Foss, Clay
Fabric group 4 Sisu, Elle, Safire
Fabric group 5 Gentle
Leather group 1 Omni
Leather group 2 Primo, Trace
Leather group 3 Max
Leather group 4 Nubuck, Organic, Vegeta, Cera

Model 4901

Nami Sofa End module 100x98 cm, Arm L or R



Designed by Damian Williamson, 2023

Fully upholstered sofa module. Inner frame of wood with cold cured foam. Cushions are fixed to the body of the sofa and all covers are non-removable. Legs in black lacquered ash mounted with felt glides. Mounted with coupling device for modular configurations. Please specify right- or left.

All sofa configurations must be finished with a right or left end module.

Modeldetails

0,84 m³ Packaging dimensions:
60 kg / L: 97 cm W: 82 cm H: 105 cm
52 kg

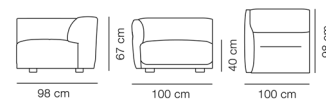

Essential Assortment

Item number	Upholstery	Legs	Module type	Price
4901016700270037900	Loop 36	Blask ash	Right module	2.715
4901016700280037900	Loop 36	Blask ash	Left module	2.715
4901020390270037900	Zero 0001	Blask ash	Right module	3.190
4901020390280037900	Zero 0001	Blask ash	Left module	3.190

Essential variants only delivered with HR foam

Order configuration

Fabric group 1	2.480
Fabric group 2	2.735
Fabric group 3	2.975
Fabric group 4	3.225
Fabric group 5	3.905
C.O.M. fabric	2.480
Leather group 1	3.605
Leather group 2	3.930
Leather group 3	4.445
Leather group 4	5.155
Leather group 5	6.380
C.O.M. leather	3.605

Fabric consumption: 4 m. Leather consumption: 8 m²

Certifications

EN 1022:2005, EN 16139:2013 (L2)

Recommended upholstery

Fabric group 1	Bardal, Capture, Natural Linen, Re-wool
Fabric group 2	Hallingdal, Barnum, Steelcut Trio, Fiord, Loop, Ruskin
Fabric group 3	Vidar, Clay, Divina Melange, Foss
Fabric group 4	Sisu, Elle, Safire
Fabric group 5	Gentle
Leather group 1	Omni
Leather group 2	Primo, Trace
Leather group 3	Max
Leather group 4	Nubuck, Vegeta, Organic

Model 4902

Nami Sofa Seat module 88x98 cm



Designed by Damian Williamson, 2023

Fully upholstered sofa module. Inner frame of wood with cold cured foam. Cushions are fixed to the body of the sofa and all covers are non-removable. Legs in black lacquered ash mounted with felt glides. Mounted with coupling device for modular configurations.

All sofa configurations must be finished with a right or left end module.

Modeldetails

0,74 m³ Packaging dimensions:
48 kg / 40 kg L: 97 cm W: 82 cm H: 93 cm

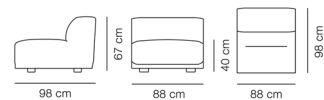

Essential Assortment

Item number	Upholstery	Legs	Price
4902016700000037900	Loop 36	Blask ash	2.360
49020203900000037900	Zero 0001	Blask ash	2.715

Essential variants only delivered with HR foam

Order configuration

Fabric group 1	2.130
Fabric group 2	2.365
Fabric group 3	2.585
Fabric group 4	2.810
Fabric group 5	3.415
C.O.M. fabric	2.130
Leather group 1	3.335
Leather group 2	3.670
Leather group 3	4.205
Leather group 4	4.930
Leather group 5	6.195
C.O.M. leather	3.335

Fabric consumption: 3,5 m. Leather consumption: 8 m²

Certifications

EN 1022:2005, EN 16139:2013 (L2)

Recommended upholstery

Fabric group 1	Bardal, Capture, Natural Linen, Re-wool
Fabric group 2	Hallingdal, Barnum, Steelcut Trio, Fiord, Loop, Ruskin
Fabric group 3	Vidar, Clay, Divina Melange, Foss
Fabric group 4	Sisu, Elle, Safire
Fabric group 5	Gentle
Leather group 1	Omni
Leather group 2	Primo, Trace
Leather group 3	Max
Leather group 4	Nubuck, Vegeta, Organic

Model 4913

Nami Sofa Corner module 96x96 cm



Designed by Damian Williamson, 2023

Fully upholstered sofa module. Inner frame of wood with cold cured foam. Cushions are fixed to the body of the sofa and all covers are non-removable. Legs in black lacquered ash mounted with felt glides. Mounted with coupling device for modular configurations.

All sofa configurations must be finished with a right or left end module.

Modeldetails

0,81 m³ Packaging dimensions:
68 kg / L: 97 cm W: 82 cm H: 101 cm
60 kg

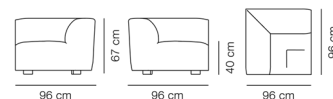

Essential Assortment

Item number	Upholstery	Legs	Price
491301670000037900	Loop 36	Blask ash	2.835
4913020390000037900	Zero 0001	Blask ash	3.310

Essential variants only delivered with HR foam

Order configuration

Fabric group 1	2.630
Fabric group 2	2.890
Fabric group 3	3.145
Fabric group 4	3.410
Fabric group 5	4.120
C.O.M. fabric	2.630
Leather group 1	3.700
Leather group 2	4.035
Leather group 3	4.570
Leather group 4	5.295
Leather group 5	6.560
C.O.M. leather	3.700

Fabric consumption: 4 m. Leather consumption: 8 m²

Certifications

EN 1022:2005, EN 16139:2013 (L2)

Recommended upholstery

Fabric group 1	Bardal, Capture, Natural Linen, Re-wool
Fabric group 2	Hallingdal, Barnum, Steelcut Trio, Fiord, Loop, Ruskin
Fabric group 3	Vidar, Clay, Divina Melange, Foss
Fabric group 4	Sisu, Elle, Safire
Fabric group 5	Gentle
Leather group 1	Omni
Leather group 2	Primo, Trace
Leather group 3	Max
Leather group 4	Nubuck, Vegeta, Organic

Model P4900

Konami / Nami Accessories Decorative cushion



Designed by Damian Williamson, 2019

Decorative cushion for Konami og Nami Sofa. Down and foam granulate filling.
Removable cover in fabric.

Order configuration

Fabric group 1	310
Fabric group 2	350
Fabric group 3	380
Fabric group 4	425
Fabric group 5	530
C.O.M. fabric	310

Fabric consumption: 0,55 m

Cushion: 50 x 50 cm.

Recommended upholstery

Fabric group 1	Bardal, Re-wool
Fabric group 2	Hallingdal, Barnum, Loop
Fabric group 3	Vidar, Clay, Divina Melange
Fabric group 4	Sisu, Elle, Safire
Fabric group 5	Gentle

Model 2002

No. 1 Sofa 2 seater



Designed by Børge Mogensen, 1955

Fully upholstered sofa with separate seat and back cushions. Interchangeable legs of solid wood mounted with metal threads. Inner frame of solid wood and plywood. Interchangeable cushions of solid CMHR or HR foam covered in fabric and mounted with buttons. Covers are non-removable. Back cushions are reversible with fabric on both sides.

Modeldetails

0,9 m³ Packaging dimensions:
83 kg / 42 kg L: 92 cm W: 148 cm H: 66 cm

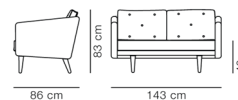

Order configuration

	Oak soap	Oak light oil / Oak oiled	Oak black lacquered / Smoked oak stained, lacquered
Fabric group 1	4.170	4.170	4.170
Fabric group 2	4.455	4.455	4.455
Fabric group 3	4.735	4.735	4.735
Fabric group 4	5.390	5.390	5.390
Fabric group 5	6.445	6.445	6.445
C.O.M. fabric	4.170	4.170	4.170

Fabric consumption: 6,3 m

Certifications

FSC® certified

Recommended upholstery

Fabric group 1	Capture, Re-wool, Bardal, Linara, Remix, Grand Linen, Erik
Fabric group 2	Hallingdal, Savoy, Barnum, Steelcut Trio, Ruskin, Fiord, Loop
Fabric group 3	Foss, Sunniva, Harald, Divina Melange, Vidar, Clay
Fabric group 4	Safire, Sisu, Elle
Fabric group 5	Gentle, Grand Mohair

Model 2003

No. 1 Sofa 3 seater

Modeldetails

1,2 m³ Packaging dimensions:
88 kg / 54 kg L: 91,5 cm W: 211 cm H: 63 cm



Designed by Børge Mogensen, 1955

Fully upholstered sofa with separate seat and back cushions. Interchangeable legs of solid wood mounted with metal threads. Inner frame of solid wood and plywood. Interchangeable cushions of solid CMHR or HR foam covered in fabric and mounted with buttons. Covers are non-removable. Back cushions are reversible with fabric on both sides.

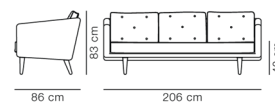

Essential Assortment

Item number	Upholstery	Legs	Price
200316011000050203	Bardal 220	Oak soap treated, FSC Mix 70%	4.965
200316014000050203	Bardal 860	Oak soap treated, FSC Mix 70%	4.965
200316015000050203	Bardal 780	Oak soap treated, FSC Mix 70%	4.965
200300201000050205	Hallingdal 180	Oak oil, FSC Mix 70%	5.555
200300219000050203	Hallingdal 130	Oak soap treated, FSC Mix 70%	5.555

Essential variants only delivered with HR foam

Order configuration

	Oak soap	Oak light oil / Oak oiled	Oak black lacquered / Smoked oak stained, lacquered
Fabric group 1	5.235	5.235	5.235
Fabric group 2	5.615	5.615	5.615
Fabric group 3	5.980	5.980	5.980
Fabric group 4	6.785	6.785	6.785
Fabric group 5	8.140	8.140	8.140
C.O.M. fabric	5.235	5.235	5.235

Fabric consumption: 8,3 m

Certifications

FSC® certified

Recommended upholstery

Fabric group 1	Capture, Re-wool, Bardal, Linara, Remix, Grand Linen, Erik
Fabric group 2	Hallingdal, Savoy, Barnum, Steelcut Trio, Ruskin, Fiord, Loop
Fabric group 3	Foss, Sunniva, Harald, Divina Melange, Vidar, Clay
Fabric group 4	Safire, Sisu, Elle
Fabric group 5	Gentle, Grand Mohair

Model 8802

Savannah Sofa 2 seater



Designed by Monica Förster, 2015

Lounge sofa with upholstered cushions. External frame of solid wood mounted with non-removable upholstery leather, fabric or 100% linen canvas. Cushions of cold cured foam upholstered in fabric. Cover is non-removable on frame and back. Cover on seat cushion is removable.

Modeldetails

1,94 m³ Packaging dimensions:
128 kg / L: 192 cm W: 97 cm H: 104 cm
62 kg

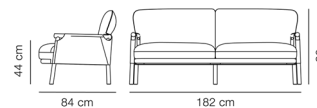

Order configuration

Frame: Oak light oil or oak black lacquered.

	Cushions: Fabric gr. 1	Cushions: Fabric gr. 2	Cushions: Fabric gr. 3	Cushions: Fabric gr. 4	Cushions: Fabric gr. 5	Cushions: Fabric COM
Leather group 1	6.400	6.855	7.070	7.725	9.240	6.400
Leather group 2	6.520	6.970	7.190	7.840	9.360	6.520
Leather group 3	6.690	7.145	7.360	8.015	9.530	6.690
Leather group 4	6.860	7.315	7.530	8.185	9.700	6.860
C.O.M. leather	6.400	6.855	7.070	7.725	9.240	6.400
Canvas black or natural	6.265	6.715	6.935	7.585	9.105	6.265

Fabric consumption: 6,1 m

Fabric consumption on frame: 1,8 m.

Leather consumption on frame: 5 m²

Note - arm cushions have to be ordered separately (P8801).

Certifications

EN 1022:2005, EN 16139:2013 (L2), ANSI/BIFMA M7.1 Standard Test Method for Determining VOC Emissions from Office (tested with ECO-label fabric and HR-foam)

Recommended upholstery

Fabric group 1	Bardal, Re-wool, Capture, Grand Linen, Erik
Fabric group 2	Hallingdal, Fiord, Steelcut Trio, Ruskin, Barnum, Loop
Fabric group 3	Sunniva, Vidar, Divina Melange, Clay
Fabric group 4	Sisu, Safire, Elle
Fabric group 5	Gentle
Leather group 0	Vice
Leather group 1	Omni
Leather group 2	Primo, Trace
Leather group 3	Max
Leather group 4	Vegeta, Nubuck, Organic

Model P8801

Savannah Accessories Set of 2 arm cushions

Modeldetails



Designed by Monica Förster, 2015

Arm cushion in foam upholstered in textile.

Order configuration

Fabric group 1	350
Fabric group 2	385
Fabric group 3	415
Fabric group 4	485
Fabric group 5	545
C.O.M. fabric	350

Fabric consumption: 0,5 m

Recommended upholstery

Fabric group 0	Connect
Fabric group 1	Grand Linen, Linara, Bardal, Capture, Re-wool, Erik
Fabric group 2	Hallingdal, Barnum, Steelcut Trio, Fiord, Ruskin, Loop
Fabric group 3	Vidar, Clay, Sunniva, Divina Melange, Foss
Fabric group 4	Sisu, Elle, Safire
Fabric group 5	Gentle

Model 1712

Spine Lounge Sofa 2 seater



Designed by Space Copenhagen, 2011

Sofa with legs of solid wood. Wooden seat shell of moulded plywood. The seat cushion in CMHR or HR foam. Available in fabric or leather, with piping in all stitches. Cushions are kept in place with Velcro fixtures and are removable for cleaning.

Modeldetails

1,14 m³ Packaging dimensions:
65 kg / 51 kg L: 87 cm W: 168 cm H: 78 cm

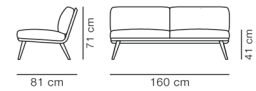

Essential Assortment

Item number	Upholstery	Wood	Price
171220200044807	Grand Linen Naturel 0024	Oak lacquer FSC Mix 70%	5.320
171222300050088	Leather Primo 88, Black	Black ash, FSC Mix 70%	5.910
171222300050841	Leather Cera 905, Russet brown	Black ash, FSC Mix 70%	7.685

Essential variants only delivered with HR foam

Order configuration

	Oak lacquered	Black ash	Smoked oak stained, lacquered
Fabric group 0	5.335	4.845	5.200
Fabric group 1	5.735	5.210	5.565
Fabric group 2	6.050	5.525	5.880
Fabric group 3	6.540	6.015	6.370
Fabric group 4	7.365	6.840	7.195
Fabric group 5	7.865	7.350	7.705
C.O.M. fabric	5.735	5.210	5.565
Leather group 0	5.755	5.375	5.730
Leather group 1	6.190	5.780	6.135
Leather group 2	7.070	6.545	6.900
Leather group 3	7.780	7.255	7.610
Leather group 4	8.555	7.980	8.335
Leather group 5	9.840	9.175	9.530
C.O.M. leather	6.190	5.780	6.135

Fabric consumption: 4,8 m. Leather consumption: 10 m²

QuickClick glides with felt upon request (R1730).

Certifications

FSC® certified
EN 15373:2007 (L2)

Recommended upholstery

Fabric group 1	Grand Linen, Linara, Bardal, Capture, Remix, Re-wool, Natural Linen, Erik
Fabric group 2	Hallingdal, Savoy, Barnum, Steelcut Trio, Fiord, Ruskin, Loop
Fabric group 3	Harald, Vidar, Clay, Sunniva, Divina Melange, Foss
Fabric group 4	Sisu, Safire, Cotil, Elle
Fabric group 5	Gentle, Grand Mohair
Leather group 0	Vice
Leather group 1	Omni
Leather group 2	Primo, Trace
Leather group 3	Max
Leather group 4	Nubuck, Organic, Vegeta, Cera

Model 1789

The Spoke-Back Sofa 2 seater



Designed by Børge Mogensen, 1945

Sofa with frame in solid wood. Seat supported by jute webbing. Interchangeable seat and back cushions in solid HR foam, covered in fabric or leather and finished with buttons. Chaise longue angle adjusted and supported with interchangeable leather straps. When covered in fabric the seat cushion is reversible. Leather seat cushion has hessian backing.

Modeldetails

1,18 m³ Packaging dimensions:
39 kg / 30 kg L: 164 cm W: 79 cm H: 91 cm

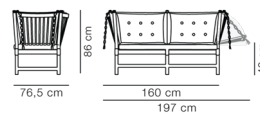

Essential Assortment

Item number	Upholstery	Wood	Price
178920344806301	Natural Linen 0003	Oak soap, FSC Mix 70%	7.685
178920314108301	Capture 4201	Oak soap, FSC Mix 70%	7.685
178920314112301	Capture 5201	Oak soap, FSC Mix 70%	7.685
178920300950301	Cotil 863, 53938	Oak soap, FSC Mix 70%	8.275
178900551301301	Leather Omni 301, Black	Black lacquered	9.340
178920350095301	Leather Max 95, Cognac	Oak soap, FSC Mix 70%	10.755

Essential variants only delivered with HR foam

Order configuration

	Oak soap	Oak oiled	Oak black lacquered
Fabric group 1	8.020	8.020	8.020
Fabric group 2	8.290	8.290	8.290
Fabric group 3	8.550	8.550	8.550
Fabric group 4	8.945	8.945	8.945
Fabric group 5	9.885	9.885	9.885
C.O.M. fabric	8.020	8.020	8.020
Leather group 1	9.460	9.460	9.460
Leather group 2	9.980	9.980	9.980
Leather group 3	10.890	10.890	10.890
Leather group 4	12.115	12.115	12.115
Leather group 5	14.190	14.190	14.190
C.O.M. leather	9.460	9.460	9.460

Certifications

Oak soap is FSC® certified

Recommended upholstery

Fabric group 1	Grand Linen, Remix, Capture, Bardal, Re-wool, Linara, Natural Linen, Erik
Fabric group 2	Hallingdal, Barnum, Steelcut Trio, Fiord, Ruskin, Savoy
Fabric group 3	Divina Melange, Vidar, Sunniva, Foss, Clay
Fabric group 4	Cotil, Sisu, Elle, Safire
Fabric group 5	Gentle
Leather group 1	Omni
Leather group 2	Primo, Trace
Leather group 3	Max
Leather group 4	Nubuck, Vegeta, Organic, Cera

Model P1789S

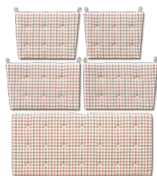

The Spoke-Back Sofa Accessories

Set of fabric cushions for 1789

Designed by Børge Mogensen

Cushions in solid HR foam, covered in fabric and finished with buttons. When covered in fabric the seat cushion is reversible.

Model details

0,12 m³
12 kg /
8,05 kg

Essential Assortment

Item number	Upholstery	Price
P1789S14108	Capture 4201	1.770
P1789S14112	Capture 5201	1.770
P1789S44806	Natural Linen 0003	1.770
P1789S00950	Cotil 863, 53938	2.125

Essential variants only delivered with HR foam

Order configuration

Fabric group 1	1.975
Fabric group 2	2.245
Fabric group 3	2.505
Fabric group 4	2.900
Fabric group 5	3.840
C.O.M. fabric	1.975

Fabric consumption: 4,5 m

Recommended upholstery

Fabric group 1	Grand Linen, Linara, Bardal, Capture, Remix, Natural Linen, Re-wool, Erik
Fabric group 2	Hallingdal, Barnum, Steelcut Trio, Fiord, Ruskin, Savoy
Fabric group 3	Vidar, Clay, Sunniva, Divina Melange, Foss
Fabric group 4	Sisu, Cotil, Elle, Safire
Fabric group 5	Gentle

Model P1789L



The Spoke-Back Sofa Accessories Set of leather cushions for 1789

Modeldetails

Designed by Børge Mogensen

Cushions in solid HR foam, covered in leather and finished with buttons. Leather seat cushion has hessian backing.

Essential Assortment

Item number	Upholstery	Price
P1789L51301	Leather Omni 301, Black	2.955
P1789L50095	Leather Max 95, Cognac	4.725

Essential variants only delivered with HR foam

Order configuration

Leather group 1	3.415
Leather group 2	3.935
Leather group 3	4.845
Leather group 4	6.070
Leather group 5	8.145
C.O.M. leather	3.415

Leather consumption: 10 m²

Recommended upholstery

Leather group 1	Omni
Leather group 2	Primo, Trace
Leather group 3	Max
Leather group 4	Nubuck, Vegeta, Organic, Cera

**Model
R1789**



The Spoke-Back Sofa Accessories
Leather straps

Modeldetails

Designed by Børge Mogensen

Leather straps for The Spoke-Back sofa. Leather straps for adjusting the angle of the chaise longue.

Order configuration

Leatherstraps in
natural each set

145

Tables

Model 6490

Ana Table Extension Table 220/320 cm

Modeldetails

0,3 m³ Packaging dimensions:
80,6 kg / 75 kg L: 228 cm W: 103 cm H: 14 cm



Designed by Arde, 2018

Table with legs of solid wood. Table top of laminated chipboard with solid wood edges, and topped with Fenix NTM laminate. Integrated butterfly extension mechanism automatically hides the extension leaves under the table top when not in use. Knock-down, delivered unassembled.



Essential Assortment

Item number	Surface	Frame	Price
649045118255000	Laminate Fenix NTM White, edge oak soap	Oak soap	3.845
649045417855000	Laminate Fenix NTM Almond, edge oak clear oil	Oak oil treated	3.845
649045618355000	Laminate Fenix NTM Black, smoked oak oil stained	Smoked oak oil stained	3.975

Order configuration

	Fenix NTM laminate white edge / frame oak soap	Fenix NTM laminate black edge / frame smoked oak oil-stained	Fenix NTM laminate almond edge / frame oak oiled
	3.845	3.975	3.845

Certifications

EN 15372:2016 (L1)

Model 6491

Ana Table Ana Extension Table 180/280 cm



Designed by Arde, 2018

Table with legs of solid wood. Table top of laminated chipboard with solid wood edges, and topped with Fenix NTM laminate. Integrated butterfly extension mechanism automatically hides the extension leaves under the table top when not in use. Knock-down, delivered unassembled.

Model details

0,27 m³ Packaging dimensions:
69 kg / 66 kg L: 188 cm W: 103 cm H: 14 cm

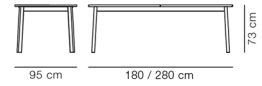

Essential Assortment

Item number	Surface	Frame	Price
649145118255100	Laminate Fenix NTM White, edge oak soap	Oak soap	3.315
649145417855100	Laminate Fenix NTM Almond, edge oak clear oil	Oak oil treated	3.315

Order configuration

	Fenix NTM laminate white edge / frame oak soap	Fenix NTM laminate almond edge / frame oak oiled
	3.315	3.315

Certifications

EN 15372:2016 (L1)

Model 6271

BM71 Library Table Gate leg table



Designed by Børge Mogensen, 1958

Gate-leg table with solid wood frame and veneered oak top in solid frame sections.

Modeldetails

1,03 m³ Packaging dimensions:
100 kg / 60 kg L: 136 cm W: 98 cm H: 77 cm

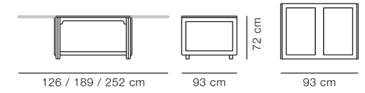

Essential Assortment

Item number	Wood	Price
6271322102	Oak lacquer	5.910
6271322105	Oak oil	5.910

Tabletop length: 126 cm.
Extended: 189 or 252 cm.

Model 6284

BM84 Mogensen Table 180x90 cm



Designed by Børge Mogensen, 1958

Rectangular table with frame and table top in solid wood. Leg mounted with a visible brass screw. Knock-down, delivered unassembled.

Modeldetails

0,18 m³ Packaging dimensions:
43 kg / 40 kg L: 185 cm W: 93 cm H: 10 cm

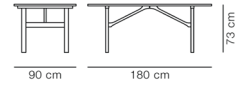

Order configuration

	Oak soap	Oak oiled	Oak light oil	Smoked oak, oiled
	3.930	3.970	3.930	4.520

Certifications

FSC® certified

Model 0290

C18 Accessories Additional leaf for 6290, 6293, 6284

Designed by Børge Mogensen

Additional leaf in black lacquered MDF. Brackets in beech wood and black powder coated steel.
Compatible with C18 table width 90 cm and BM84 (6284).

Modeldetails

0,04 m³ Packaging dimensions:
7 kg / 4,5 kg L: 47 cm W: 96 cm H: 16 cm

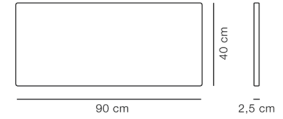

Order configuration

Black lacquered
(each)

380

Model 6286

BM86 Mogensen Shaker Table 195x97.5 cm



Designed by Børge Mogensen, 1964

Rectangular table with frame and table top in solid wood. Leg mounted with a visible brass screw. Knock-down, delivered unassembled.

Modeldetails

0,2 m³ Packaging dimensions:
62 kg / 56 kg L: 203 cm W: 104 cm H: 10 cm



Order configuration

	Oak soap	Oak oiled	Oak light oil	Smoked oak, oiled
	5.545	5.585	5.545	6.380

Model 6386

BM86 Mogensen Shaker Table 245x97.5 cm



Designed by Børge Mogensen, 1964

Rectangular table with frame and table top in solid wood. Leg mounted with a visible brass screw. Knock-down, delivered unassembled.

Modeldetails

0,26 m³ Packaging dimensions:
72 kg / 66 kg L: 265 cm W: 100 cm H: 10 cm

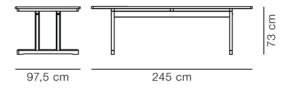

Order configuration

Oak soap	Oak oiled	Oak light oil	Smoked oak, oiled
6.665	6.700	6.665	7.665

**Model
0286**

BM86 Accessories
Additional leaf for 6286 / 6386

Designed by Børge Mogensen

Additional leaf in black lacquered MDF for BM86 table. Brackets in beech wood and black powder coated steel.

Modeldetails

0,07 m³ Packaging dimensions:
7,25 kg / L: 47 cm W: 104 cm H: 16 cm
6 kg

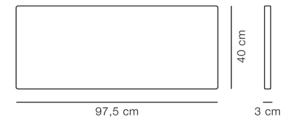

Order configuration

**Black lacquered
(each)**

380

Model 6292

C18 Mogensen Shaker Table 160x80 cm



Designed by Børge Mogensen, 1947

Rectangular table with frame and table top in solid wood. Leg mounted with a visible brass screw. Knock-down, delivered unassembled.

Modeldetails

0,14 m³ Packaging dimensions:
34 kg / 29 kg L: 165 cm W: 83 cm H: 10 cm

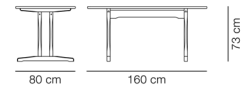

Essential Assortment

Item number	Wood	Price
6292183203	Oak soap, FSC Mix 70%	2.955
6292183205	Oak oil, FSC Mix 70%	2.955
6292183206	Oak light oil, FSC Mix 70%	2.955

Order configuration

	Oak soap	Oak oiled	Oak light oil	Smoked oak, oiled
	2.955	2.955	2.955	3.510

Certifications

FSC® certified

Model 0292

C18 Accessories Additional leaf for 6292

Designed by Børge Mogensen

Additional leaf in black lacquered MDF for C18 table in width 80 cm. Brackets in beech wood and black powder coated steel.

Modeldetails

0,04 m³ Packaging dimensions:
5,7 kg / 4,5 kg L: 47 cm W: 86 cm H: 16 cm

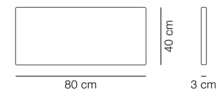

Order configuration

Black lacquered
(each)

370

Model 6290

C18 Mogensen Shaker Table 180x90 cm



Designed by Børge Mogensen, 1947

Rectangular table with frame and table top in solid wood. Leg mounted with a visible brass screw. Knock-down, delivered unassembled.

Modeldetails

0,18 m³ Packaging dimensions:
42,7 kg / 39 kg L: 185 cm W: 93 cm H: 10 cm

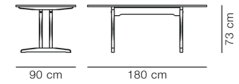

Essential Assortment

Item number	Wood	Price
6290197203	Oak soap, FSC Mix 70%	3.545
6290197205	Oak oil, FSC Mix 70%	3.545
6290197206	Oak light oil, FSC Mix 70%	3.545
6290197207	Smoked oak, oiled, FSC Mix 70%	4.135

Order configuration

	Oak soap	Oak oiled	Oak light oil	Smoked oak, oiled
	3.545	3.545	3.545	4.135

Certifications

FSC® certified

Model 6293

C18 Mogensen Shaker Table 220x90 cm



Designed by Børge Mogensen, 1947

Rectangular table with frame and table top in solid wood. Leg mounted with a visible brass screw. Knock-down, delivered unassembled.

Modeldetails

0,22 m³ Packaging dimensions:
55 kg / 48 kg L: 230 cm W: 100 cm H: 10 cm

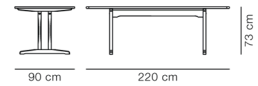

Essential Assortment

Item number	Wood	Price
6293195203	Oak soap, FSC Mix 70%	4.725
6293195205	Oak oil, FSC Mix 70%	4.725
6293195206	Oak light oil, FSC Mix 70%	4.725
6293195207	Smoked oak, oiled, FSC Mix 70%	5.320

Order configuration

	Oak soap	Oak oiled	Oak light oil	Smoked oak, oiled
	4.725	4.725	4.725	5.320

Certifications

FSC® certified

Model 0290

C18 Accessories Additional leaf for 6290, 6293, 6284

Designed by Børge Mogensen

Additional leaf in black lacquered MDF. Brackets in beech wood and black powder coated steel.
Compatible with C18 table width 90 cm and BM84 (6284).

Modeldetails

0,04 m³ Packaging dimensions:
7 kg / L: 47 cm W: 96 cm H: 16 cm
4,5 kg

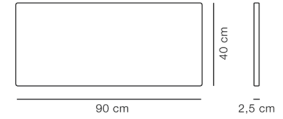

Order configuration

Black lacquered
(each)

380

Model 6775

Islets Table Ø120 cm



Designed by Maria Bruun, 2020

Table with legs and table top of solid hardwood. Legs mounted to table top with metal thread. Knock-down, delivered unassembled. Assembled without the use of screws and tools.

Modeldetails

0,26 m³ Packaging dimensions:
62,5 kg / 54 kg L: 135/84 cm W: 135/36 cm H: 8/36 cm

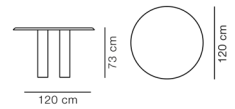

Essential Assortment

Item number	Wood	Price
67752067300	Oak light oil, FSC Mix 70%	5.320
67752077300	Smoked oak, oiled, FSC Mix 70%	5.910

Certifications

FSC® certified

Model 6568

JG Table Ø140 cm



Designed by Jørgen Gammelgaard, 1984

Table with base in stainless steel or powder coated steel. Table top in stone or linoleum. Table tops in linoleum has chipboard core with solid wood edging. Black linoleum with black colored through wood edge. Grey linoleum with light oiled wood edge. Glides included as standard.

Modeldetails

2,1 m³ Packaging dimensions:
130 kg / 87 kg L: 150 / 80 cm W: 150 / 75 cm H: 60 / 8 cm

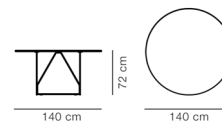

Essential Assortment

Item number	Surface	Frame	Edge	Price
65682150317950340	Black linoleum	Black lacquer	Black oak	2.950
65682140260150340	Grey linoleum / Vapour 4177	Brushed stainless steel	Natural ash	3.685
65686060017950340	Black Marquina	Black lacquer	without	5.160
65686050060150340	White Carrara	Brushed stainless steel	without	5.900
65686500060150340	Ivory Quartzite	Brushed stainless steel	without	7.230

Order configuration

	Grey linoleum with natural ash edge	Black linoleum with black oak edge	White Carrara	Black Marquina	Ivory Quartzite
Black	3.065	2.950	5.400	5.160	6.790
Stainless steel, brushed	3.685	3.780	5.900	6.115	7.230

Net weight: Linoleum 25 kg, Stone 87 kg.



Extra charge for

Protective coating on stone table top: +414

Model 6569

JG Table 140x140 cm

Modeldetails

 2,1 m³ Packaging dimensions:
 152 kg / 109 kg L: 150 / 80 cm W: 150 / 75 cm H: 60 / 8 cm



Designed by Jørgen Gammelgaard, 1984

Table with legs in stainless steel or powder coated steel. Table top in stone or linoleum. Table tops in linoleum has chipboard core with solid wood edging. Black linoleum with black colored through wood edge. Grey linoleum with light oiled wood edge. Glides included as standard.

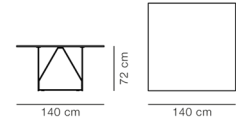

Essential Assortment

Item number	Surface	Frame	Edge	Price
65692150317950440	Black linoleum	Black lacquer	Black oak	2.950
65692140260150440	Grey linoleum / Vapour 4177	Brushed stainless steel	Natural ash	3.685
65696060017950440	Black Marquina	Black lacquer	without	5.160
65696050060150440	White Carrara	Brushed stainless steel	without	5.605
65696500060150440	Ivory Quartzite	Brushed stainless steel	without	7.375

Order configuration

	Grey linoleum with natural edge	Black linoleum with black oak edge	White Carrara	Black Marquina	Ivory Quartzite
Black	3.135	2.950	5.340	5.160	6.825
Stainless steel, brushed	3.685	3.880	5.605	6.085	7.375

Net weight: Linoleum 31 kg, Stone 109 kg.

Extra charge for

Protective coating on stone table top: +414

Certifications

EN 15372:2016 (L3)

Model 6631

Plan Table Table 200 x 100 cm

Modeldetails

0,34 m³ Packaging dimensions:
60 kg / 50 kg L: 87/205 cm W: 87/105,5 cm H: 15/15 cm



Designed by Edward Barber & Jay Osgerby, 2022

Table with base in tubular steel, brushed or powder coated. Tabletop in Fenix NTM laminate, Really textile-plate delivered with straight edges or solid wood with a rounded edge profile. Mounted with plastic glides. Cable management set and cut out available. Cables can be led through the base leg and the plastic glide included. Cover for cut out available in black powder coated metal or natural saddle leather made from leftovers from the production of The Spanish Chair.

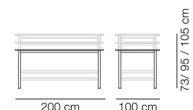

Essential Assortment

Item number	Surface	Frame	Size	Price
663132545804004000	Laminate Fenix NTM Black	Black	Height 73 cm	1.475
663132510704004000	Oak light oil	Black	Height 73 cm	2.245
663132510705004000	Oak light oil	Brushed steel	Height 73 cm	2.835

Order configuration

Frame: Brushed Steel or standard colours: Black, Modernist green, Bordeaux

	Fenix NTM laminate black	Really, Cotton Cream	Oak light oil	Smoked oak, oiled
Standard colours ht. 73 cm	1.475	1.890	2.245	2.480
Brushed Steel ht. 73 cm	2.245	2.480	2.835	3.070
Standard colours ht. 95 cm	2.065	2.305	2.480	2.715
Brushed Steel ht. 95 cm	3.070	3.310	3.665	3.900
Standard colours ht. 105cm	2.065	2.305	2.480	2.715
Brushed Steel ht. 105 cm	3.070	3.310	3.665	3.900

For special orders, some table tops will be made with a straight edge that matches the table top.
Spare parts: Glides without felt (R6631G).

Netto weight (73 / 95 / 105 cm):
50 kg / 65 kg / 66 kg

Extra charge for

Cover for cut out in black powder coated steel or natural saddle leather: +354
Incl. cable tray in black powder coated
Fixed tables in height 105 cm is available with castors w. brakes +354

Certifications

EN 15372:2016 (L3)

Model 6632

Plan Table Extendable 200 / 260 x 100 cm



Designed by Edward Barber & Jay Osgerby, 2022

Extendable table with base in tubular steel, brushed or powder coated. Tabletop in Fenix NTM laminate or solid wood and with space for storing an additional plate. Additional plate is the same material as table top. Solid wood table tops will be delivered with rounded edge profile. Laminate table tops will be delivered with straight edges. Mounted with plastic glides. No felt glides available.

Modeldetails

0,32 m³ Packaging dimensions:
71 kg / 68 kg L: 87/205 cm W: 87/105,5 cm H:
15/15 cm

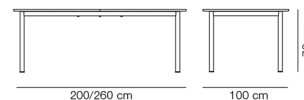

Essential Assortment

Item number	Surface	Frame	Price
663232145804004000	Laminate Fenix NTM Black	Black	2.420
663232110704004000	Oak light oil	Black	3.190
663232110705004000	Oak light oil	Brushed steel	3.780

Order configuration

Frame: Brushed Steel or standard colours: Black, Modernist green, Bordeaux

	Fenix NTM laminate black	Oak light oil	Smoked oak, oiled
Standard colours ht. 73 cm	2.420	3.190	3.425
Brushed Steel ht. 73 cm	3.190	3.780	4.015

Nettovægt (73 / 95 / 105 cm):
50 kg / 65 kg / 66 kg

Certifications

EN 15372:2016 (L3)

Model 665A

Plan Table Configuration A, 260 x 100 cm

Modeldetails



Designed by Edward Barber & Jay Osgerby, 2022

Base in tubular steel, brushed or powder coated. Tabletop in Fenix NTM laminate or Really textile table top. Standard table tops will be delivered with straight edges. Mounted with plastic glides. No felt glides available. Cable management set and cut out available. Cables can be led through the base leg and out through the plastic glider included in the Cable management set. Cover for cut out available in black powder coated metal or natural saddle leather made from leftover leather from the production of The Spanish Chair.

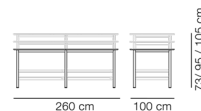

Order configuration

Frame: Brushed Steel or standard colours: Black, Modernist green, Bordeaux

	Fenix NTM laminat black	Really, Cotton Cream
Standard colours ht. 73 cm	2.355	2.955
Brushed Steel ht. 73 cm	3.780	4.250
Standard colours ht. 95 cm	3.180	3.780
Brushed Steel ht. 95 cm	4.725	5.195
Standard colours ht. 105cm	3.180	3.780
Brushed Steel ht. 105 cm	4.725	5.195

For special orders, some table tops will be made with a straight edge that matches the table top.
Spare parts: Glides without felt (R6631G).

Extra charge for

Cover for cut out in black powder coated steel or natural saddle leather (2 pcs.) +708
Incl. 2 cable trays in black powder coated

Certifications

EN 15372:2016 (L3)

Model 665C

Plan Table Configuration C, 320 x 100 cm

Modeldetails



Designed by Edward Barber & Jay Osgerby, 2022

Base in tubular steel, brushed or powder coated. Tabletop in Fenix NTM laminate or Really textile table top. Standard table tops will be delivered with straight edges. Mounted with plastic glides. No felt glides available. Cable management set and cut out available. Cables can be led through the base leg and out through the plastic glider included in the Cable management set. Cover for cut out available in black powder coated metal or natural saddle leather made from leftover leather from the production of The Spanish Chair.

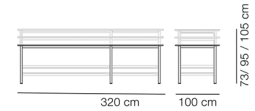

Order configuration

Frame: Brushed Steel or standard colours: Black, Modernist green, Bordeaux

	Fenix NTM laminat black	Really, Cotton Cream
Standard colours ht. 73 cm	2.770	3.425
Brushed Steel ht. 73 cm	4.250	4.780
Standard colours ht. 95 cm	3.360	4.075
Brushed Steel ht. 95 cm	4.960	5.665
Standard colours ht. 105cm	3.360	4.075
Brushed Steel ht. 105 cm	4.960	5.665

For special orders, some table tops will be made with a straight edge that matches the table top.
Spare parts: Glides without felt (R6631G).

Extra charge for

Cover for cut out in black powder coated steel or natural saddle leather (2 pcs.) +708
Incl. 2 cable trays in black powder coated

Certifications

EN 15372:2016 (L3)

Model 665E

Plan Table Configuration E, 380 x 100 cm

Modeldetails



Designed by Edward Barber & Jay Osgerby, 2022

Base in tubular steel, brushed or powder coated. Tabletop in Fenix NTM laminate or Really textile table top. Standard table tops will be delivered with straight edges. Mounted with plastic glides. No felt glides available. Cable management set and cut out available. Cables can be led through the base leg and out through the plastic glider included in the Cable management set. Cover for cut out available in black powder coated metal or natural saddle leather made from leftover leather from the production of The Spanish Chair.

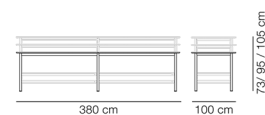

Order configuration

Frame: Brushed Steel or standard colours: Black, Modernist green, Bordeaux

	Fenix NTM laminat black	Really, Cotton Cream
Standard colours ht. 73 cm	3.185	3.895
Brushed Steel ht. 73 cm	4.720	5.310
Standard colours ht. 95 cm	3.540	4.370
Brushed Steel ht. 95 cm	5.195	6.135
Standard colours ht. 105cm	3.540	4.370
Brushed Steel ht. 105 cm	5.195	6.135

For special orders, some table tops will be made with a straight edge that matches the table top.
Spare parts: Glides without felt (R6631G).

Extra charge for

Cover for cut out in black powder coated steel or natural saddle leather (2 pcs.) +708
Incl. 2 cable trays in black powder coated

Certifications

EN 15372:2016 (L3)

Model 665G

Plan Table Configuration G, 440 x 100 cm

Modeldetails

Designed by Edward Barber & Jay Osgerby, 2022



Base in tubular steel, brushed or powder coated. Tabletop in Fenix NTM laminate or Really textile table top. Standard table tops will be delivered with straight edges. Mounted with plastic glides. No felt glides available. Cable management set and cut out available. Cables can be led through the base leg and out through the plastic glider included in the Cable management set. Cover for cut out available in black powder coated metal or natural saddle leather made from leftover leather from the production of The Spanish Chair.

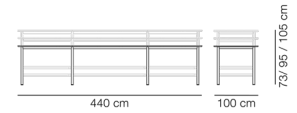

Order configuration

Frame: Brushed Steel or standard colours: Black, Modernist green, Bordeaux

	Fenix NTM laminat black	Really, Cotton Cream
Standard colours ht. 73 cm	3.770	4.725
Brushed Steel ht. 73 cm	5.670	6.610
Standard colours ht. 95 cm	4.950	5.905
Brushed Steel ht. 95 cm	7.200	8.145
Standard colours ht. 105cm	4.950	5.905
Brushed Steel ht. 105 cm	7.200	8.145

For special orders, some table tops will be made with a straight edge that matches the table top.
Spare parts: Glides without felt (R6631G).

Extra charge for

Cover for cut out in black powder coated steel or natural saddle leather (3 pcs.) +1.062
Incl. 3 cable trays in black powder coated

Certifications

EN 15372:2016 (L3)

Model 665M

Plan Table Configuration M, 500 x 100 cm

Modeldetails



Designed by Edward Barber & Jay Osgerby, 2022

Base in tubular steel, brushed or powder coated. Tabletop in Fenix NTM laminate or Really textile table top. Standard table tops will be delivered with straight edges. Mounted with plastic glides. No felt glides available. Cable management set and cut out available. Cables can be led through the base leg and out through the plastic glider included in the Cable management set. Cover for cut out available in black powder coated metal or natural saddle leather made from leftover leather from the production of The Spanish Chair.

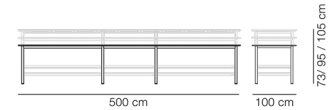

Order configuration

Frame: Brushed Steel or standard colours: Black, Modernist green, Bordeaux

	Fenix NTM laminat black	Really, Cotton Cream
Standard colours ht. 73 cm	4.245	5.310
Brushed Steel ht. 73 cm	6.255	7.315
Standard colours ht. 95 cm	4.955	6.255
Brushed Steel ht. 95 cm	7.670	8.965
Standard colours ht. 105cm	4.955	6.255
Brushed Steel ht. 105 cm	7.670	8.965

For special orders, some table tops will be made with a straight edge that matches the table top.
Spare parts: Glides without felt (R6631G).

Extra charge for

Cover for cut out in black powder coated steel or natural saddle leather (3 pcs.) +1.062
Incl. 3 cable trays in black powder coated

Certifications

EN 15372:2016 (L3)

Model 665K

Plan Table Configuration K, 560 x 100 cm

Designed by Edward Barber & Jay Osgerby, 2022



Base in tubular steel, brushed or powder coated. Tabletop in Fenix NTM laminate or Really textile table top. Standard table tops will be delivered with straight edges. Mounted with plastic glides. No felt glides available. Cable management set and cut out available. Cables can be led through the base leg and out through the plastic glider included in the Cable management set. Cover for cut out available in black powder coated metal or natural saddle leather made from leftover leather from the production of The Spanish Chair.

Modeldetails

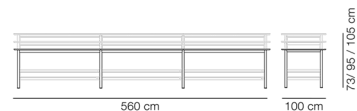

Order configuration

Frame: Brushed Steel or standard colours: Black, Modernist green, Bordeaux

	Fenix NTM laminat black	Really, Cotton Cream
Standard colours ht. 73 cm	4.600	5.665
Brushed Steel ht. 73 cm	6.610	7.670
Standard colours ht. 95 cm	5.310	6.495
Brushed Steel ht. 95 cm	7.670	9.085
Standard colours ht. 105cm	5.310	6.495
Brushed Steel ht. 105 cm	7.670	9.085

For special orders, some table tops will be made with a straight edge that matches the table top.
Spare parts: Glides without felt (R6631G).

Extra charge for

Cover for cut out in black powder coated steel or natural saddle leather (3 pcs.) +1.062
Incl. 3 cable trays in black powder coated

Certifications

EN 15372:2016 (L3)

Model 667B

Plan Table Configuration B, 260 x 120cm

Modeldetails



Designed by Edward Barber & Jay Osgerby, 2022

Base in tubular steel, brushed or powder coated. Tabletop in Fenix NTM laminate. Standard table tops will be delivered with straight edges. Mounted with plastic glides. No felt glides available. Cable management set and cut out available. Cables can be led through the base leg and out through the plastic glider included in the Cable management set. Cover for cut out available in black powder coated metal or natural saddle leather made from leftover leather from the production of The Spanish Chair.

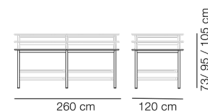

Order configuration

Frame: Brushed Steel or standard colours: Black, Modernist green, Bordeaux

	Fenix NTM laminate black
Standard colours ht. 73 cm	2.535
Brushed Steel ht. 73 cm	3.780
Standard colours ht. 95 cm	3.180
Brushed Steel ht. 95 cm	4.835
Standard colours ht. 105cm	3.180
Brushed Steel ht. 105 cm	4.835

For special orders, some table tops will be made with a straight edge that matches the table top.
Spare parts: Glides without felt (R6631G).

Extra charge for

Cover for cut out in black powder coated steel or natural saddle leather (2 pcs.) +708
Incl. 2 cable trays in black powder coated

Certifications

EN 15372:2016 (L3)

Model 667D

Plan Table Configuration D, 320 x 120cm

Designed by Edward Barber & Jay Osgerby, 2022



Base in tubular steel, brushed or powder coated. Tabletop in Fenix NTM laminate. Standard table tops will be delivered with straight edges. Mounted with plastic glides. No felt glides available. Cable management set and cut out available. Cables can be led through the base leg and out through the plastic glider included in the Cable management set. Cover for cut out available in black powder coated metal or natural saddle leather made from leftover leather from the production of The Spanish Chair.

Modeldetails

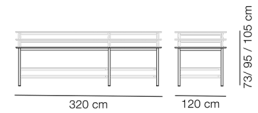

Order configuration

Frame: Brushed Steel or standard colours: Black, Modernist green, Bordeaux

	Fenix NTM laminate black
Standard colours ht. 73 cm	3.040
Brushed Steel ht. 73 cm	4.250
Standard colours ht. 95 cm	3.535
Brushed Steel ht. 95 cm	5.130
Standard colours ht. 105cm	3.535
Brushed Steel ht. 105 cm	5.130

For special orders, some table tops will be made with a straight edge that matches the table top.
Spare parts: Glides without felt (R6631G).

Extra charge for

Cover for cut out in black powder coated steel or natural saddle leather (2 pcs.) +708
Incl. 2 cable trays in black powder coated

Certifications

EN 15372:2016 (L3)

Model 667F

Plan Table Configuration F, 380 x 120cm

Modeldetails



Designed by Edward Barber & Jay Osgerby, 2022

Base in tubular steel, brushed or powder coated. Tabletop in Fenix NTM laminate. Standard table tops will be delivered with straight edges. Mounted with plastic glides. No felt glides available. Cable management set and cut out available. Cables can be led through the base leg and out through the plastic glider included in the Cable management set. Cover for cut out available in black powder coated metal or natural saddle leather made from leftover leather from the production of The Spanish Chair.

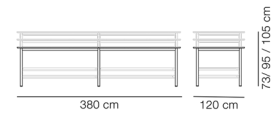

Order configuration

Frame: Brushed Steel or standard colours: Black, Modernist green, Bordeaux

	Fenix NTM laminate black
Standard colours ht. 73 cm	3.545
Brushed Steel ht. 73 cm	4.720
Standard colours ht. 95 cm	3.890
Brushed Steel ht. 95 cm	5.425
Standard colours ht. 105cm	3.890
Brushed Steel ht. 105 cm	5.425

For special orders, some table tops will be made with a straight edge that matches the table top.
Spare parts: Glides without felt (R6631G).

Extra charge for

Cover for cut out in black powder coated steel or natural saddle leather (2 pcs.) +708
Incl. 2 cable trays in black powder coated

Certifications

EN 15372:2016 (L3)

Model 667H

Plan Table Configuration H, 440 x 120cm

Designed by Edward Barber & Jay Osgerby, 2022



Base in tubular steel, brushed or powder coated. Tabletop in Fenix NTM laminate. Standard table tops will be delivered with straight edges. Mounted with plastic glides. No felt glides available. Cable management set and cut out available. Cables can be led through the base leg and out through the plastic glider included in the Cable management set. Cover for cut out available in black powder coated metal or natural saddle leather made from leftover leather from the production of The Spanish Chair.

Modeldetails

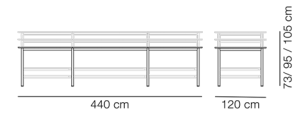

Order configuration

Frame: Brushed Steel or standard colours: Black, Modernist green, Bordeaux

	Fenix NTM laminate black
Standard colours ht. 73 cm	3.890
Brushed Steel ht. 73 cm	5.670
Standard colours ht. 95 cm	4.950
Brushed Steel ht. 95 cm	7.310
Standard colours ht. 105cm	4.950
Brushed Steel ht. 105 cm	7.310

For special orders, some table tops will be made with a straight edge that matches the table top.
Spare parts: Glides without felt (R6631G).

Extra charge for

Cover for cut out in black powder coated steel or natural saddle leather (3 pcs.) +1.062
Incl. 3 cable trays in black powder coated

Certifications

EN 15372:2016 (L3)

Model 667J

Plan Table Configuration J, 500 x 120cm

Modeldetails



Designed by Edward Barber & Jay Osgerby, 2022

Base in tubular steel, brushed or powder coated. Tabletop in Fenix NTM laminate. Standard table tops will be delivered with straight edges. Mounted with plastic glides. No felt glides available.

Cable management set and cut out available. Cables can be led through the base leg and out through the plastic glider included in the Cable management set. Cover for cut out available in black powder coated metal or natural saddle leather made from leftover leather from the production of The Spanish Chair.

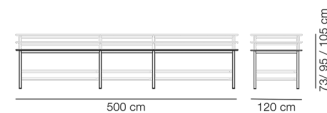

Order configuration

Frame: Brushed Steel or standard colours: Black, Modernist green, Bordeaux

	Fenix NTM laminat black
Standard colours ht. 73 cm	4.605
Brushed Steel ht. 73 cm	6.430
Standard colours ht. 95 cm	5.420
Brushed Steel ht. 95 cm	8.140
Standard colours ht. 105cm	5.420
Brushed Steel ht. 105 cm	8.140

For special orders, some table tops will be made with a straight edge that matches the table top.
Spare parts: Glides without felt (R6631G).

Extra charge for

Cover for cut out in black powder coated steel or natural saddle leather (3 pcs.) +1.062
Incl. 3 cable trays in black powder coated

Certifications

EN 15372:2016 (L3)

Model 667L

Plan Table Configuration L, 560 x 120cm

Designed by Edward Barber & Jay Osgerby, 2022



Base in tubular steel, brushed or powder coated. Tabletop in Fenix NTM laminate. Standard table tops will be delivered with straight edges. Mounted with plastic glides. No felt glides available. Cable management set and cut out available. Cables can be led through the base leg and out through the plastic glider included in the Cable management set. Cover for cut out available in black powder coated metal or natural saddle leather made from leftover leather from the production of The Spanish Chair.

Modeldetails

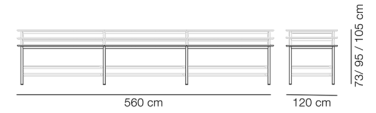

Order configuration

Frame: Brushed Steel or standard colours: Black, Modernist green, Bordeaux

	Fenix NTM laminate black
Standard colours ht. 73 cm	4.900
Brushed Steel ht. 73 cm	6.610
Standard colours ht. 95 cm	5.660
Brushed Steel ht. 95 cm	7.900
Standard colours ht. 105cm	5.660
Brushed Steel ht. 105 cm	7.900

For special orders, some table tops will be made with a straight edge that matches the table top.
Spare parts: Glides without felt (R6631G).

Extra charge for

Cover for cut out in black powder coated steel or natural saddle leather (3 pcs.) +1.062
Incl. 3 cable trays in black powder coated

Certifications

EN 15372:2016 (L3)

Plan Table - Overview

Model 665A, Configuration: A
MODEL 6652 / 6652 + 1 pcs. 6650

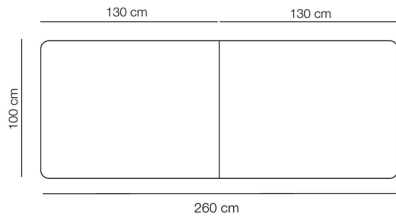

Model 667B, Configuration: B
MODEL 6672 / 6672 + 1 pcs. 6670

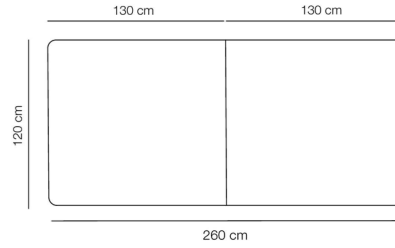

Model 665C, Configuration: C
MODEL 6652 / 6651 + 1 pcs. 6650

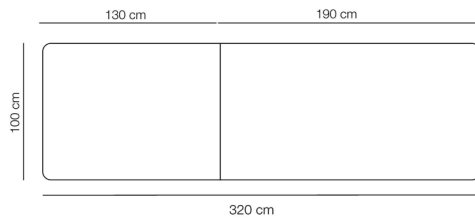

Model 667D, Configuration: D
MODEL 6672 / 6671 + 1 pcs. 6670

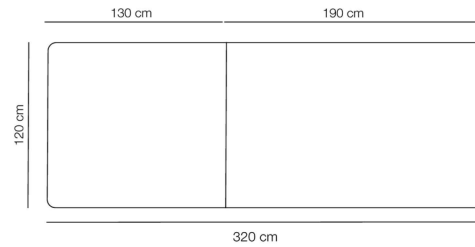

Model 665E, Configuration: E
MODEL 6651 / 6651 + 1 pcs. 6650

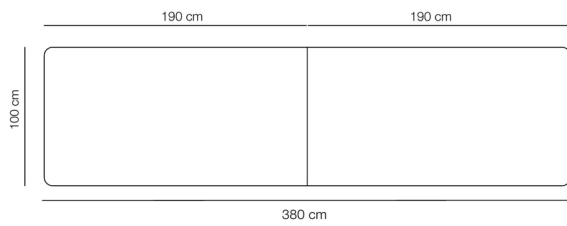

Model 667F, Configuration: F
MODEL 6671 / 6671 + 1. pcs. 6670

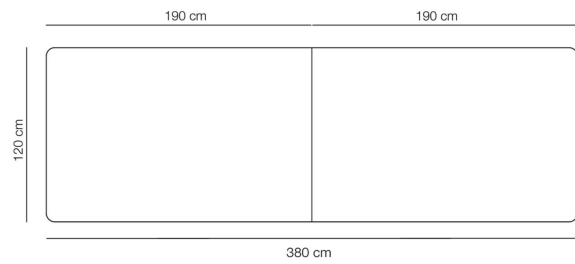

Model 665G, Configuration: G
MODEL 6652 / 6654 / 6652 + 2. pcs. 6650

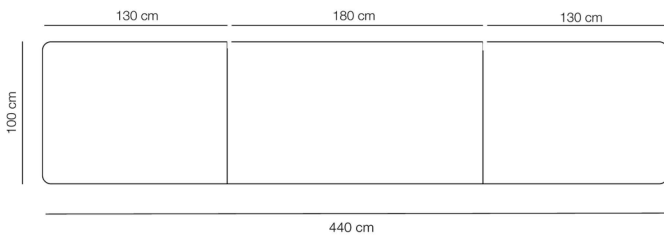

Model 667H, Configuration: H
MODEL 6672 / 6674 / 6672 + 2. pcs 6670

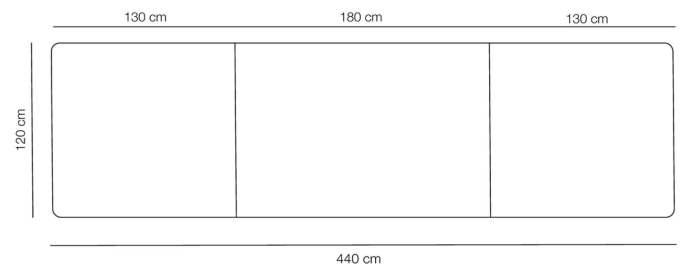

For customer's own configuration, please attach to the order a visual sketch of the desired layout

Plan Table - Overview

Model 665M, Configuration: M
MODEL 6651 / 6655 / 6651 + 2. pcs 6650

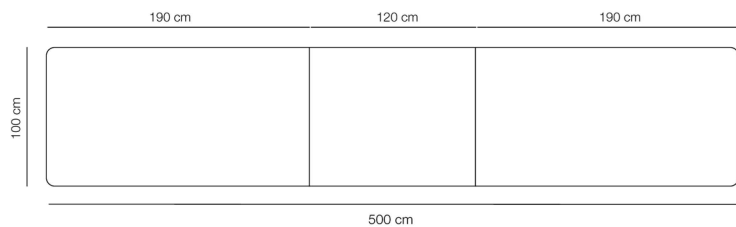

Model 667J, Configuration: J
MODEL 6671 / 6675 / 6671 + 2. pcs 6670

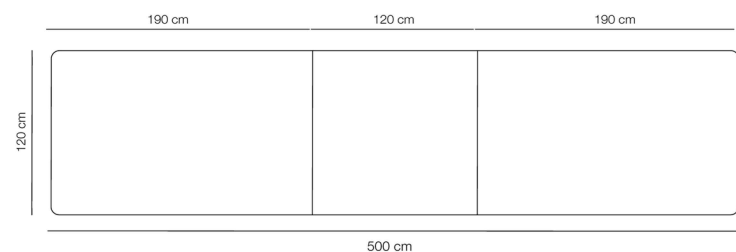

Model 665K, Configuration: K
MODEL 6651 / 6654 / 6651 + 2. pcs 6650

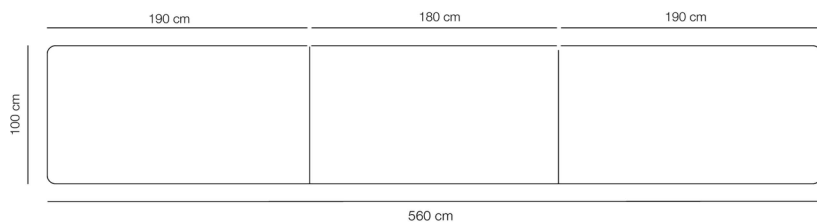

Model 667L, Configuration: L
MODEL 6671 / 6674 / 6671 + 2. pcs 6670

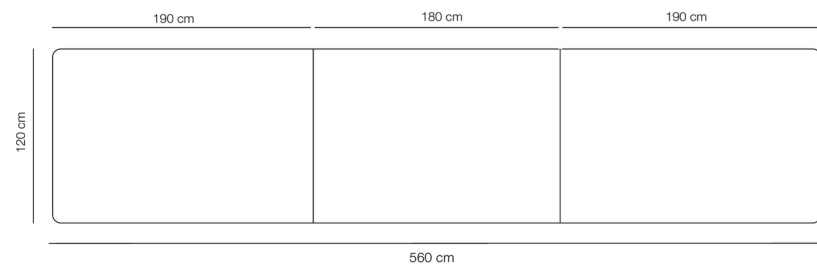

For customer's own configuration, please attach to the order a visual sketch of the desired layout

Model 6624

Plan Table Column 70x60 cm



Designed by Edward Barber & Jay Osgerby, 2023

Column table. Frame in powder coated steel and aluminum. Table top in stone with a full rounded edge profile and solid wood, veneer, linoleum or laminate with a straight edge. Delivered with felt glides. Available in different heights.

Model details

0,08 m³ Packaging dimensions:
46 kg / 41 kg L: 55/21/81 cm W: 55/128/71 cm H: 10/17/11 cm

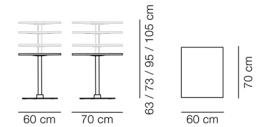

Order configuration

Height: 63, 73, 95 or 105 cm.

	White Carrara	Fenix NTM laminate black	Oak light oil	Smoked oak, oiled
Black	1.180	590	885	1.000
Modernist green	1.180	590	885	1.000
Bordeaux	1.180	590	885	1.000

Net weight (63 / 73 / 95 / 105 cm):

Stone 40 / 40 / 40 / 41 kg., Laminate 22 / 22 / 23 / 23 kg., Wood 23 / 23 / 24 / 24 kg.

Extra charge for

Protective coating on stone table top:	+206
UV varnish on wood table top:	+206
Frame in brushed stainless steel:	+355

Certifications

Oak is FSC® certified

EN 15372:2016 (L3)

Model 6627

Plan Table Column Ø72 cm



Designed by Edward Barber & Jay Osgerby, 2023

Column table. Frame in powder coated steel and aluminum. Table top in stone with a full rounded edge profile and solid wood, veneer, linoleum or laminate with a straight edge. Delivered with felt glides. Available in different heights.

Modeldetails

0,08 m³ Packaging dimensions:
45 kg / 40 kg L: 55/21/83 cm W: 55/128/83 cm H: 10/17/11 cm



Order configuration

Height: 63, 73, 95 or 105 cm.

	White Carrara	Fenix NTM laminate black	Oak light oil	Smoked oak, oiled
Black	1.395	660	945	1.060
Modernist green	1.395	660	945	1.060
Bordeaux	1.395	660	945	1.060

Net weight (63 / 73 / 95 / 105 cm):

Stone 39 / 39 / 40 / 40 kg., Laminate 22 / 22 / 23 / 23 kg., Wood 23 / 23 / 24 / 24 kg.

Extra charge for

Protective coating on stone table top:	+206
UV varnish on wood table top:	+206
Frame in brushed stainless steel:	+355

Certifications

Oak is FSC® certified
EN 15372:2016 (L3)

Model 6629



Plan Table Column Ø90 cm

Designed by Edward Barber & Jay Osgerby, 2023

Column table. Frame in powder coated steel and aluminum. Table top in stone with a full rounded edge profile and solid wood, veneer, linoleum or laminate with a straight edge. Delivered with felt glides. Available in different heights.

Modeldetails

0,09 m³ Packaging dimensions:
57 kg / 52 kg L: 55/21/101 cm W: 55/128/101 cm
H: 10/17/11 cm



Order configuration

Height: 63, 73, 95 or 105 cm.

	White Carrara	Fenix NTM laminate black	Oak light oil	Smoked oak, oiled
Black	1.770	825	1.120	1.180
Modernist green	1.770	825	1.120	1.180
Bordeaux	1.770	825	1.120	1.180

Net weight (63 / 73 / 95 / 105 cm):

Stone 51 / 52 / 52 / 52 kg., Laminate 25 / 25 / 25 / 26 kg., Wood 27 / 27 / 27 / 28 kg.

Extra charge for

Protective coating on stone table top:	+206
UV varnish on wood table top:	+206
Frame in brushed stainless steel:	+355

Certifications

Oak is FSC® certified
EN 15372:2016 (L3)

Model 6438

Post Table 225x100 cm



Designed by Cecilie Manz, 2019

Legs and table top in solid wood. Knock-down, delivered unassembled.

Modeldetails

0,41 m³ Packaging dimensions:
80 kg / L: 108/234 cm W: 79/108 cm H:
71,5 kg 15/11 cm

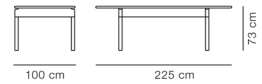

Essential Assortment

Item number	Wood	Price
6438452206	Oak light oil, FSC Mix 70%	3.975
6438452207	Smoked oak, oiled, FSC Mix 70%	4.820

Order configuration

	Oak soap	Oak light oil	Oak lacquered	Smoked oak, oiled
	4.300	3.975	4.515	4.820

Certifications

FSC® certified
EN 15372:2016 (L2)

Model 6440

Post Table 265x100 cm



Designed by Cecilie Manz, 2019

Legs and table top in solid wood. Knock-down, delivered unassembled.

Modeldetails

0,45 m³ Packaging dimensions:
91 kg / L: 108/269 cm W: 79/108 cm H:
76,5 kg 15/11 cm

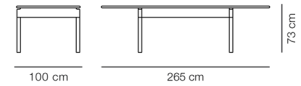

Essential Assortment

Item number	Wood	Price
6440451206	Oak light oil, FSC Mix 70%	4.820
6440451207	Smoked oak, oiled, FSC Mix 70%	6.025

Order configuration

	Oak soap	Oak light oil	Oak lacquered	Smoked oak, oiled
	5.240	4.820	5.450	6.025

Certifications

FSC® certified
EN 15372:2016 (L2)

Model 6441

Post Table 270x100 cm



Designed by Cecilie Manz, 2019

Legs and table top in solid wood. Knock-down, delivered unassembled.

Modeldetails

0,5 m³ Packaging dimensions:
94,5 kg / 80 kg L: 108/274 cm W: 79/108 cm H:
15/11 cm

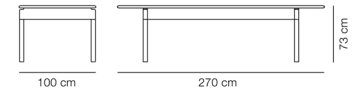

Essential Assortment

Item number	Wood	Price
6441453206	Oak light oil, FSC Mix 70%	4.820
6441453207	Smoked oak, oiled, FSC Mix 70%	6.025

Order configuration

	Oak soap	Oak light oil	Oak lacquered	Smoked oak, oiled
	5.240	4.820	5.450	6.025

Certifications

FSC® certified
EN 15372:2016 (L2)

Model 6442

Post Table 320x100 cm



Designed by Cecilie Manz, 2019

Legs and table top in solid wood. Knock-down, delivered unassembled.

Modeldetails

0,52 m³ Packaging dimensions:
106 kg / L: 108/329 cm W: 79/108 cm H:
85,5 kg 15/11 cm

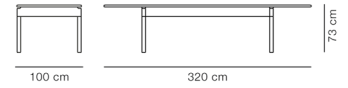

Order configuration

	Oak soap	Oak light oil	Oak lacquered	Smoked oak, oiled
	6.750	6.750	6.975	8.100

Certifications

FSC® certified
EN 15372:2016 (L2)

Model 6106

Taro Table 220x93.5 cm



Designed by Jasper Morrison, 2016

Rectangular table with legs and table top in solid wood. Knock-down, delivered unassembled.

Modeldetails

0,33 m³ Packaging dimensions:
57 kg / 54 kg L: 228 cm W: 102 cm H: 11 cm

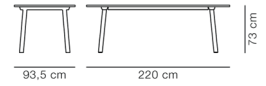

Order configuration

	Oak soap	Oak oiled	Oak light oil	Oak lacquered	Smoked oak, oiled
	4.800	4.835	4.800	5.015	5.505

Certifications

FSC® certified
EN 15372:2008 (L3)

Model 6121

Taro Table Ø120 cm



Designed by Jasper Morrison, 2016

Small table with legs and table top in solid wood. Knock-down, delivered unassembled.

Modeldetails

0,38 m³ Packaging dimensions:
51 kg / 41,5 kg L: 135 cm W: 135 cm H: 5,5 cm

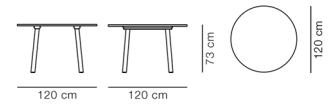

Order configuration

	Oak soap	Oak oiled	Oak light oil	Oak lacquered	Smoked oak, oiled
	2.985	3.025	2.985	3.190	3.435

Certifications

FSC® certified

Coffee & Side Tables

Model 5367

BM67 Coffee Table



Designed by Børge Mogensen, 1956

Coffee table. Frame in solid wood, with brackets in solid brass or powder coated steel. Table top in solid oak. Knock-down, delivered unassembled.

Modeldetails

0,1 m³ Packaging dimensions:
18 kg / L: 143 cm W: 58 cm H: 12 cm
14,75 kg

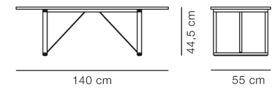

Essential Assortment

Item number	Wood	Frame	Price
536710790313300	Oak light oil	Brackets in brass	1.770

Order configuration

	Oak soap	Oak oil	Oak light oil	Smoked oak, oiled
Brackets: Black	1.970	2.050	1.970	2.190
Brackets: Brass	1.970	2.050	1.770	2.190

Model 5190

Insula Coffee Table 72x76 cm

Designed by Ernst & Jensen, 2009

Coffee table in solid aluminum finished with textured powder coating or Brushed aluminium with clear matt powder coating. Mounted with plastic glides. Knock down, delivered unassembled.



Modeldetails

0,05 m³ Packaging dimensions:
12 kg / 10 kg L: 86 cm W: 77 cm H: 6 cm

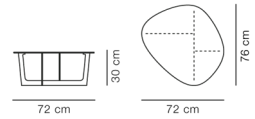

Essential Assortment

Item number	Surface	Price
51903013013000	Aluminium, textured black lacquer	885
51904024023000	Brushed aluminium, clear matt powder coating	945

Certifications

EN 15372:2008 (L2)

Model 5191

Insula Coffee Table 95x98 cm

Designed by Ernst & Jensen, 2009

Coffee table in solid aluminum finished with textured powder coating or Brushed aluminium with clear matt powder coating. Mounted with plastic glides. Knock down, delivered unassembled.



Modeldetails

0,08 m³ Packaging dimensions:
19 kg / 16 kg L: 110 cm W: 95 cm H: 6 cm

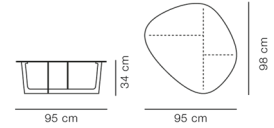

Essential Assortment

Item number	Surface	Price
51913013013400	Aluminium, textured black lacquer	1.180
51914024023400	Brushed aluminium, clear matt powder coating	1.300

Certifications

EN 15372:2008 (L2)

Model 5192

Insula Coffee Table 118x121 cm



Designed by Ernst & Jensen, 2009

Coffee table in solid aluminum finished with textured powder coating. Mounted with plastic glides. Knockdown, delivered unassembled.

Modeldetails

0,6 m³ Packaging dimensions:
30 kg / 26 kg L: 126 cm W: 103 cm H: 45 cm

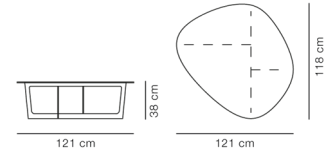

Essential Assortment

Item number	Surface	Price
51923013013800	Aluminium, textured black lacquer	2.210

Certifications

EN 15372:2008 (L2)

Model 5198

Insula Piccolo Table Side table



Designed by Ernst & Jensen, 2014

Side table in two heights. Tabletop in aluminum, base in steel. Finished with textured powder coating. Mounted with natural fibre glides, as an alternative to felt. Please specify table height.

Model details

0,2 m³ Packaging dimensions:
15,5 kg / 12 kg L: 47 cm W: 46 cm H: 76 cm

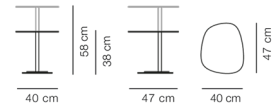

Essential Assortment

Item number	Surface	Height	Price
51983013015800	Aluminium, textured black lacquer	58 cm	410

Order configuration

Frame: Black aluminium.

Table top:
Aluminium
black

Height 38 cm	410
Height 58 cm	410

Model 6770

Islets Side Table 40x40 cm



Designed by Maria Bruun, 2020

Side table with legs and table top of solid hardwood. Legs mounted to table top with metal thread. Knock-down, delivered assembled.

Modeldetails

0,05 m³ Packaging dimensions:
11 kg / 9 kg L: 55/55 cm W: 55/21 cm H: 8/21 cm

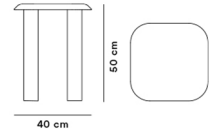

Essential Assortment

Item number	Wood	Price
67701075200	Oak light oil	1.535
67702075200	Smoked oak, oiled, FSC Mix 70%	1.665

Certifications

Smoked oak is FSC® certified
EN 15372:2016 (L3)

Model 6772

Islets Coffee Table 110x110 cm

Designed by Maria Bruun, 2020

Coffee table with legs and table top of solid hardwood. Legs mounted to table top with metal thread. Knock-down, delivered assembled.



Modeldetails

0,15 m³ Packaging dimensions:
35,5 kg / 28 kg L: 125/35 cm W: 125/25 cm H: 8/25 cm

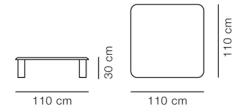

Essential Assortment

Item number	Wood	Price
67722063000	Oak light oil, FSC Mix 70%	3.200
67722073000	Smoked oak, oiled, FSC Mix 70%	3.330

Certifications

FSC® certified
EN 15372:2016 (L3)

Model 6558

JG Coffee Table Ø98 cm



Designed by Jørgen Gammelgaard, 1962

Coffee table with base in solid aluminium, brushed and finished with a clear powder coating. Tabletop in 12 mm tempered low-iron glass. Mounted with plastic glides. Knock-down, delivered unassembled.

Modeldetails

0,12 m³ Packaging dimensions:
33 kg / 30 kg L: 102 / 58 cm W: 102 / 31 cm H: 8 / 18 cm

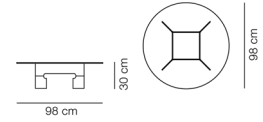

Essential Assortment

Item number	Surface	Frame	Price
65581855669804000	12 mm tempered glass	Brushed aluminium with clear powder lacq.	2.125

Model 6804

Niveau Coffee Table Ø45 cm



Designed by Cecilie Manz, 2023

Table top in 20 mm stone. Base in solid wood done with a hollow construction. Table top is attached to base with metal thread. Delivered with felt glides. Delivered disassembled. Available in different heights.

Modeldetails

0,08 m³ Packaging dimensions:
22 kg / 17 kg L: 32/57 cm W: 32/57,5 cm H: 42/10,5 cm

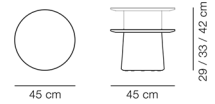

Essential Assortment

Item number	Surface	Frame	Size	Price
680460618690779	Black Marquina	Ash brown stained oil treated, FSC Mix 70%	Ø45 cm, height 29 cm	1.180
680460618690879	Black Marquina	Ash brown stained oil treated, FSC Mix 70%	Ø45 cm, height 42 cm	1.180
680461118590779	Tundra Grey	Ash oil treated, FSC Mix 70%	Ø45 cm, height 29 cm	1.180
680461118590879	Tundra Grey	Ash oil treated, FSC Mix 70%	Ø45 cm, height 42 cm	1.180

Order configuration

Height: 29 or 42 cm.

	Tundra Grey	Black Marquina
Ash oil treated	1.180	1.235
Ash brown stained	1.235	1.180

Extra charge for

Protective coating on stone table top: +206

Certifications

FSC® certified
EN 15372:2016 (L2)

Model 6806

Niveau Coffee Table Ø61 cm



Designed by Cecilie Manz, 2023

Table top in 20 mm stone. Base in solid wood done with a hollow construction. Table top is attached to base with metal thread. Delivered with felt glides. Delivered disassembled.

Modeldetails

0,1 m³ Packaging dimensions:
32,5 kg / 23 kg L: 32/73 cm W: 32/73,5 cm H: 42/10,5 cm

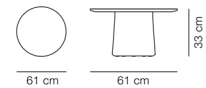

Essential Assortment

Item number	Surface	Frame	Size	Price
680660618690679	Black Marquina	Ash brown stained oil treated, FSC Mix 70%	Ø61 cm, height 33 cm	1.535
680661118590679	Tundra Grey	Ash oil treated, FSC Mix 70%	Ø61 cm, height 33 cm	1.535

Order configuration

	Tundra Grey	Black Marquina
Ash oil treated	1.535	1.600
Ash brown stained	1.600	1.535

Extra charge for

Protective coating on stone table top: +206

Certifications

FSC® certified
EN 15372:2016 (L2)

Model 6811

Niveau Coffee Table Ø110 cm



Designed by Cecilie Manz, 2023

Table top in 20 mm sten. Base in solid wood done with a hollow construction. Table top is attached to base with metal thread. Delivered with felt glides. Delivered disassembled.

Modeldetails

0,31 m³ Packaging dimensions:
112 kg / 68 kg L: 62/122 cm W: 62/122,5 cm H: 38/11 cm

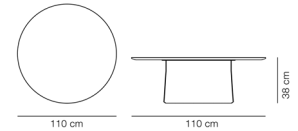

Essential Assortment

Item number	Surface	Frame	Size	Price
681160618690979	Black Marquina	Ash brown stained oil treated, FSC Mix 70%	Ø110 cm, height 38 cm	3.545
681161118590979	Tundra Grey	Ash oil treated, FSC Mix 70%	Ø110 cm, height 38 cm	3.545

Order configuration

	Grey Tundra	Black Marquina
Ash oil treated	3.545	3.600
Ash brown stained	3.600	3.545

Extra charge for

Protective coating on stone table top: +414

Certifications

FSC® certified
EN 15372:2016 (L2)

Model 6751

Pal Side Table Ø37.5 cm



Designed by Keiji Takeuchi, 2020

Side table with table top in solid wood, base in stainless steel or powder coated steel. Table top is attached to base with metal thread. Delivered disassembled. Mounted with felt glides. Available in different heights.

Modeldetails

0,07 m³ Packaging dimensions:
8,6 kg / L: 41/32 cm W: 41/32 cm H: 6/
7,1 kg (41/48/55) cm

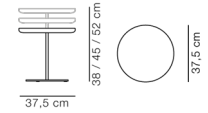

Essential Assortment

Item number	Wood	Frame	Size	Price
675120617938300	Oak light oil, FSC Mix 70%	Black lacquer	Height 45 cm	470
675116417938300	Walnut oiled	Black lacquer	Height 45 cm	590
675120660138300	Oak light oil, FSC Mix 70%	Brushed stainless steel	Height 45 cm	650
675116460138300	Walnut oiled	Brushed stainless steel	Height 45 cm	765

Order configuration

Available in three heights: 38, 45 or 52 cm.

	Oak light oil	Oak lacquered	Oak black lacquered	Walnut oil	Walnut lacquered
Black	470	615	515	590	725
Stainless steel, brushed	650	775	670	765	895

Certifications

Oak is FSC® certified
EN 15372:2016 (L2)

Model 6755

Pal Side Table Ø44 cm



Designed by Keiji Takeuchi, 2020

Sidetable with table top in solid wood, base in stainless steel or powder coated steel. Table top is attached to base with metal thread. Delivered disassembled. Mounted with felt glides. Available in different heights.

Modeldetails

0,07 m³ Packaging dimensions:
9,25 kg / 7,75 kg L: 48/32 cm W: 48/32 cm H: 6/
(41/48/55) cm

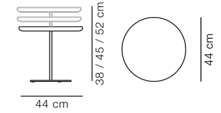

Essential Assortment

Item number	Wood	Frame	Size	Price
675520617938700	Oak light oil, FSC Mix 70%	Black lacquer	Height 52 cm	540
675516417938700	Walnut oiled	Black lacquer	Height 52 cm	665
675520660138700	Oak light oil, FSC Mix 70%	Brushed stainless steel	Height 52 cm	720
675516460138700	Walnut oiled	Brushed stainless steel	Height 52 cm	855

Order configuration

Available in three heights: 38, 45 or 52 cm.

	Oak light oil	Oak lacquered	Oak black lacquered	Walnut oil	Walnut lacquered
Black	540	680	570	665	800
Stainless steel, brushed	720	845	735	855	980

Certifications

Oak is FSC® certified
EN 15372:2016 (L2)

Model 6798

Piloti Wood Coffee Table Nest of tables

Modeldetails



Designed by Hugo Passos, 2016

Coffee tables with legs and table top in solid hardwood. Legs mounted to table top with metal thread. Knock-down, delivered unassembled. Assembled without the use of screws and tools.

Essential Assortment

Item number	Combination	Wood	Price
6798011206	Piloti Small nest, 6700 (H35) + 6705 (H41)	Oak light oil, FSC Mix 70%	720
6798011224	Piloti Small nest, 6700 (H35) + 6705 (H41)	Oak black lacquer, FSC Mix 70%	720
6798011207	Piloti Small nest, 6700 (H35) + 6705 (H41)	Smoked oak, oiled, FSC Mix 70%	840
6798012206	Piloti Medium nest, 6705 (H41) + 6715 (H35)	Oak light oil, FSC Mix 70%	1.085
6798012224	Piloti Medium nest, 6705 (H41) + 6715 (H35)	Oak black lacquer, FSC Mix 70%	1.085
6798012207	Piloti Medium nest, 6705 (H41) + 6715 (H35)	Smoked oak, oiled, FSC Mix 70%	1.205
6798013206	Piloti Large nest, 6720 (H41) + 6725 (H35)	Oak light oil, FSC Mix 70%	1.445
6798013224	Piloti Large nest, 6720 (H41) + 6725 (H35)	Oak black lacquer, FSC Mix 70%	1.445
6798013207	Piloti Large nest, 6720 (H41) + 6725 (H35)	Smoked oak, oiled, FSC Mix 70%	1.565

Certifications

FSC® certified
EN 15372:2016 (L1)

Model 6700

Piloti Wood Coffee Table 39x31 cm



Designed by Hugo Passos, 2016

Legs and table top in solid hardwood. Legs mounted to table top with metal thread. Knock-down, delivered unassembled. Assembled without the use of screws and tools. Available in two heights, please specify 35 cm or 41 cm.

Model details

0,02 m³ Packaging dimensions:
3,3 kg / 2,3 kg L: 47 cm W: 38 cm H: 10 cm

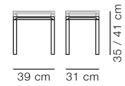

Essential Assortment

Item number	Wood	Height	Price
67002063500	Oak light oil, FSC Mix 70%	35 cm	360
67002243500	Oak black lacquer, FSC Mix 70%	35 cm	360
67002073500	Smoked oak, oiled, FSC Mix 70%	35 cm	385

Order configuration

Height: 35 or 41 cm.

Oak soap	Oak oiled	Oak light oil	Oak lacquered	Oak black lacquered	Smoked oak, oiled
457	457	360	593	360	385

Certifications

FSC® certified
EN 15372:2016 (L1)

Model 6705

Piloti Wood Coffee Table 46.5x39 cm



Designed by Hugo Passos, 2016

Legs and table top in solid hardwood. Legs mounted to table top with metal thread. Knock-down, delivered unassembled. Assembled without the use of screws and tools. Available in two heights, please specify 35 cm or 41 cm.

Model details

0,03 m³ Packaging dimensions:
4,7 kg / 2,8 kg L: 56 cm W: 46 cm H: 10 cm

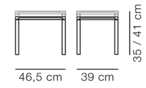

Essential Assortment

Item number	Wood	Height	Price
67052064100	Oak light oil, FSC Mix 70%	41 cm	505
67052244100	Oak black lacquer, FSC Mix 70%	41 cm	505
67052074100	Smoked oak, oiled, FSC Mix 70%	41 cm	565

Order configuration

Height: 35 or 41 cm.

Oak soap	Oak oiled	Oak light oil	Oak lacquered	Oak black lacquered	Smoked oak, oiled
560	560	505	630	505	565

Certifications

FSC® certified
EN 15372:2016 (L1)

Model 6715

Piloti Wood Coffee Table 120x39 cm



Designed by Hugo Passos, 2016

Legs and table top in solid hardwood. Legs mounted to table top with metal thread. Knock-down, delivered unassembled. Assembled without the use of screws and tools. Available in two heights, please specify 35 cm or 41 cm.

Model details

0,06 m³ Packaging dimensions:
9,5 kg / 6,3 kg L: 128 cm W: 46 cm H: 10 cm

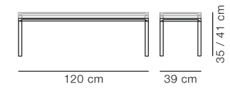

Essential Assortment

Item number	Wood	Height	Price
67152063500	Oak light oil, FSC Mix 70%	35 cm	765
67152243500	Oak black lacquer, FSC Mix 70%	35 cm	765
67152073500	Smoked oak, oiled, FSC Mix 70%	35 cm	895

Order configuration

Height: 35 or 41 cm.

Oak soap	Oak oiled	Oak light oil	Oak lacquered	Oak black lacquered	Smoked oak, oiled
885	885	765	960	765	895

Certifications

FSC® certified
EN 15372:2016 (L1)

Model 6720

Piloti Wood Coffee Table 75x75 cm



Designed by Hugo Passos, 2016

Legs and table top in solid hardwood. Legs mounted to table top with metal thread. Knock-down, delivered unassembled. Assembled without the use of screws and tools. Available in two heights, please specify 35 cm or 41 cm.

Model details

0,06 m³ Packaging dimensions:
11,7 kg / 10 kg L: 82 cm W: 81 cm H: 10 cm

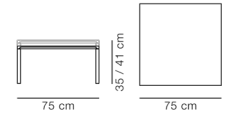

Essential Assortment

Item number	Wood	Height	Price
67202064100	Oak light oil, FSC Mix 70%	41 cm	885
67202244100	Oak black lacquer, FSC Mix 70%	41 cm	885
67202074100	Smoked oak, oiled, FSC Mix 70%	41 cm	1.010

Order configuration

Height: 35 or 41 cm.

	Oak soap	Oak oiled	Oak light oil	Oak lacquered	Oak black lacquered	Smoked oak, oiled
	970	970	885	1.040	885	1.010

Certifications

FSC® certified
EN 15372:2016 (L1)

Model 6725

Piloti Wood Coffee Table 63x63 cm



Designed by Hugo Passos, 2016

Legs and table top in solid hardwood. Legs mounted to table top with metal thread. Knock-down, delivered unassembled. Assembled without the use of screws and tools. Available in two heights, please specify 35 cm or 41 cm.

Modeldetails

0,05 m³ Packaging dimensions:
8,5 kg / 7,5 kg L: 70 cm W: 69 cm H: 10 cm

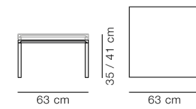

Essential Assortment

Item number	Wood	Height	Price
67252063500	Oak light oil, FSC Mix 70%	35 cm	755
67252243500	Oak black lacquer, FSC Mix 70%	35 cm	755
67252073500	Smoked oak, oiled, FSC Mix 70%	35 cm	885

Order configuration

Height: 35 or 41 cm.

Oak soap	Oak oiled	Oak light oil	Oak lacquered	Oak black lacquered	Smoked oak, oiled
875	875	755	945	755	885

Certifications

FSC® certified
EN 15372:2016 (L1)

Model 6610

Piloti Alu table 75x39 cm



Designed by Hugo Passos, 2021

Coffee table with table top in stone or Fenix NTM laminate with a black core. Base in powder coated aluminium or brushed aluminium. Mounted with plastic glides, which can adjusted in height for uneven floors.

Modeldetails

0,06 m³ Packaging dimensions:
18 kg / L: 83/87 cm W: 46/50,5 cm H: 9/4,5
16,5 kg cm

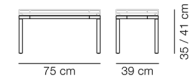

Order configuration

Frame: Black or brushed aluminium.

Height: 35 or 41 cm.

	Fenix NTM laminate black	White Carrara	Black Marquina
Black	980	1.375	1.375
Brushed aluminium	1.275	1.745	1.745

Extra charge for

Protective coating on stone table top: +206

Certifications

EN 15372:2016 (L3)

Model 6615

Piloti Alu table 120x39 cm



Designed by Hugo Passos, 2021

Coffee table with table top in stone or Fenix NTM laminate with a black core. Base in powder coated aluminium or brushed aluminium. Mounted with plastic glides, which can be adjusted in height for uneven floors.

Modeldetails

0,08 m³ Packaging dimensions:
27,5 kg / 24 kg L: 127/132 cm W: 46/51 cm H: 8/4,5 cm

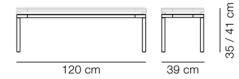

Order configuration

Frame: Black or brushed aluminium.

Height: 35 or 41 cm.

	Fenix NTM laminate black	White Carrara	Black Marquina
Black	1.155	1.735	1.735
Brushed aluminium	1.510	1.975	1.975

Extra charge for

Protective coating on stone table top: +206

Certifications

EN 15372:2016 (L3)

Model 6620

Piloti Alu table 75x75 cm



Designed by Hugo Passos, 2021

Coffee table with table top in stone or Fenix NTM laminate with a black core. Base in powder coated aluminium or brushed aluminium. Mounted with plastic glides, which can be adjusted in height for uneven floors.

Modeldetails

0,09 m³ Packaging dimensions:
32 kg / 29,5 kg L: 82/87 cm W: 83/88 cm H: 8/4,5 cm

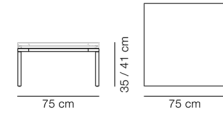

Order configuration

Frame: Black or brushed aluminium.

Height: 35 or 41 cm.

	Fenix NTM laminate black	White Carrara	Black Marquina
Black	1.155	1.735	1.735
Brushed aluminium	1.510	1.975	1.975

Extra charge for

Protective coating on stone table top: +206

Certifications

EN 15372:2016 (L3)

Model 1280

Pon Side Table Ø35 cm



Designed by Jasper Morrison, 2016

Side table in solid wood. Table top, column and base are joined with steel rods. The table can be disassembled for maintenance. Delivered assembled.

Modeldetails

0,06 m³ Packaging dimensions:
8,5 kg / 7,5 kg L: 38,5 cm W: 38,5 cm H: 39,5 cm

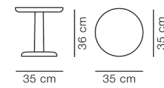

Essential Assortment

Item number	Wood	Price
12802053600	Oak oil, FSC Mix 70%	660
12802063600	Oak light oil, FSC Mix 70%	660
12802073600	Smoked oak, oiled, FSC Mix 70%	720

Order configuration

	Oak soap	Oak oiled	Oak light oil	Smoked oak, oiled	Oak lacquered	Oak black lacquered
	695	660	660	720	810	765

Certifications

FSC® certified
EN 15372:2016 (L1)

Model 1285

Pon Side Table Ø40 cm



Designed by Jasper Morrison, 2016

Side table in solid wood. Table top, column and base are joined with steel rods. The table can be disassembled for maintenance. Delivered assembled.

Modeldetails

0,11 m³ Packaging dimensions:
9,6 kg / 8,4 kg L: 43,5 cm W: 43,5 cm H: 44,5 cm

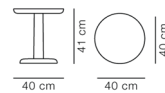

Essential Assortment

Item number	Wood	Price
12852054100	Oak oil, FSC Mix 70%	695
12852064100	Oak light oil, FSC Mix 70%	695
12852074100	Smoked oak, oiled, FSC Mix 70%	755

Order configuration

	Oak soap	Oak oiled	Oak light oil	Smoked oak, oiled	Oak lacquered	Oak black lacquered
	750	695	695	755	860	835

Certifications

FSC® certified
EN 15372:2016 (L1)

Model 1290

Pon Side Table Ø45 cm



Designed by Jasper Morrison, 2016

Side table in solid wood. Table top, column and base are joined with steel rods. The table can be disassembled for maintenance. Delivered assembled.

Modeldetails

0,12 m³ Packaging dimensions:
7,9 kg / 6,6 kg L: 49 cm W: 49 cm H: 50 cm

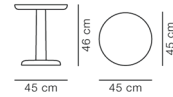

Essential Assortment

Item number	Wood	Price
12902054600	Oak oil, FSC Mix 70%	755
12902064600	Oak light oil, FSC Mix 70%	755
12902074600	Smoked oak, oiled, FSC Mix 70%	885

Order configuration

	Oak soap	Oak oiled	Oak light oil	Smoked oak, oiled	Oak lacquered	Oak black lacquered
	820	755	755	885	930	985

Certifications

FSC® certified
EN 15372:2016 (L1)

Model 1295

Pon Coffee Table Ø90 cm



Designed by Jasper Morrison, 2016

Coffee table in solid wood. Table top, column and base are joined with steel rod. The table can be disassembled for maintenance. Knock-down, delivered unassembled.

Modeldetails

0,11 m³ Packaging dimensions:
25 kg / 20 kg L: 94 cm W: 105 cm H: 11 cm

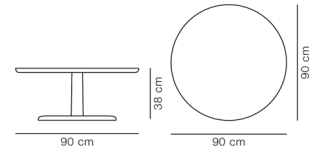

Essential Assortment

Item number	Wood	Price
12952053800	Oak oil, FSC Mix 70%	2.170
12952063800	Oak light oil, FSC Mix 70%	2.170
12952073800	Smoked oak, oiled, FSC Mix 70%	2.490

Order configuration

	Oak soap	Oak oiled	Oak light oil	Smoked oak, oiled	Oak lacquered	Oak black lacquered
	2.240	2.170	2.170	2.490	2.350	2.585

Certifications

FSC® certified
EN 15372:2016 (L1)

Model 1960

Tableau Table Ø100 cm



Designed by Space Copenhagen, 2018

Fixed position coffee table made from Portuguese limestone. Table top of limestone, reinforced underside with fiber web. Base of intersecting limestone plates. The table must be assembled on site by professionals. Never sit or stand on your marble tabletop and avoid placing particularly heavy items on it.

Modeldetails

1,25 m³ Packaging dimensions:
123 kg / 78 kg L: 108 cm W: 26 cm H: 108 cm

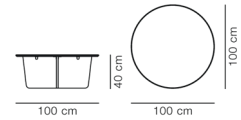

Essential Assortment

Item number	Surface	Price
19606005064000	Dark Atlantico Limestone	3.435

Extra charge for

Protective coating on stone table top: +414

Model 1966

Tableau Table 100x100 cm



Designed by Space Copenhagen, 2018

Fixed position coffee table made from Portuguese limestone. Table top of limestone, reinforced underside with fiber web. Base of intersecting limestone plates. The table must be assembled on site by professionals. Never sit or stand on your marble tabletop and avoid placing particularly heavy items on it.

Modeldetails

1,55 m³ Packaging dimensions:
128 kg / L: 108 cm W: 26 cm H: 108 cm
83 kg

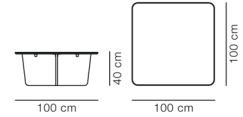

Essential Assortment

Item number	Surface	Price
19666005074000	Dark Atlantico Limestone	3.485

Extra charge for

Protective coating on stone table top: +414

Model 1965

Tableau Table 140x140 cm



Designed by Space Copenhagen, 2018

Fixed position coffee table made from Portuguese limestone. Table top of limestone, reinforced underside with fiber web. Base of intersecting limestone plates. The table must be assembled on site by professionals. Never sit or stand on your marble tabletop and avoid placing particularly heavy items on it.

Modeldetails

2 m³ Packaging dimensions:
260 kg / L: 148,5 cm W: 26 cm H: 148,5 cm
152 kg

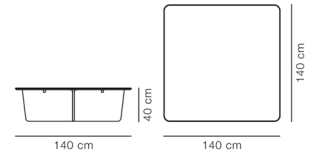

Essential Assortment

Item number	Surface	Price
19656005044000	Dark Atlantico Limestone	5.570

Extra charge for

Protective coating on stone table top: +414

Model 1028

Wegner Ox Table Ø80 cm

Designed by Hans J. Wegner, 1960

Table top in veneer as per original designed construction. Core of furniture board. Edge in solid wood. Always mounted with plastic glides. Available in two heights, please specify height.



Modeldetails

0,05 m³ Packaging dimensions:
15 kg / 13,6 kg L: 83 / 51 cm W: 83 / 30 cm H: 5,5 / 6 cm

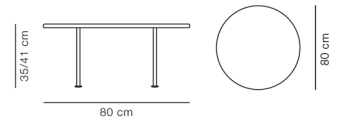

Essential Assortment

Item number	Surface	Frame	Height	Price
10287056013500	Oak oil, FSC Mix 70%	Brushed stainless steel	35 cm	1.365
10287056014100	Oak oil, FSC Mix 70%	Brushed stainless steel	41 cm	1.365
10281646013500	Walnut oil	Brushed stainless steel	35 cm	1.910
10281646014100	Walnut oil	Brushed stainless steel	41 cm	1.910

Order configuration

Height: 35 or 41 cm.

	Oak lacquered	Oak oil	Walnut oil
Stainless steel, brushed	1.575	1.365	1.910

Certifications

Oak is FSC® certified

Model 1020

Wegner Ox Table Ø100 cm



Designed by Hans J. Wegner, 1960

Table top in veneer as per original designed construction. Core of MDF. Edge in solid wood. Always mounted with plastic glides. Available in two heights, please specify height.

Modeldetails

0,07 m³ Packaging dimensions:
20 kg / L: 103 / 51 cm W: 103 / 30 cm H:
18,6 kg 5,5 / 6 cm

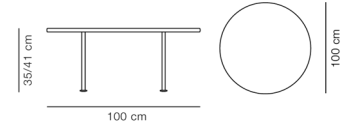

Essential Assortment

Item number	Surface	Frame	Height	Price
10207056013500	Oak oil, FSC Mix 70%	Brushed stainless steel	35 cm	1.910
10207056014100	Oak oil, FSC Mix 70%	Brushed stainless steel	41 cm	1.910

Order configuration

Height: 35 or 41 cm.

	Oak lacquered	Oak oil
Stainless steel, brushed	2.000	1.910

Certifications

Oak is FSC® certified

Model 1022

Wegner Ox Table Ø120 cm



Designed by Hans J. Wegner, 1960

Table top in veneer as per original designed construction. Core of MDF. Edge in solid wood. Always mounted with plastic glides. Available in two heights, please specify height.

Modeldetails

0,1 m³ Packaging dimensions:
28 kg / L: 123 / 51 cm W: 123 / 51 cm H:
24,6 kg 5,5 / 6 cm

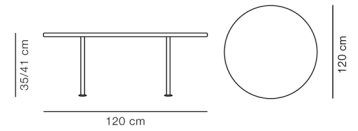

Essential Assortment

Item number	Surface	Frame	Height	Price
10227056013500	Oak oil, FSC Mix 70%	Brushed stainless steel	35 cm	2.180
10227056014100	Oak oil, FSC Mix 70%	Brushed stainless steel	41 cm	2.180
10221646013500	Walnut oil	Brushed stainless steel	35 cm	2.455
10221646014100	Walnut oil	Brushed stainless steel	41 cm	2.455

Order configuration

Height: 35 or 41 cm.

	Oak lacquered	Oak oil	Walnut oil
Stainless steel, brushed	2.300	2.180	2.455

Certifications

Oak is FSC® certified

Model 1025

Wegner Ox Table Ø150 cm



Designed by Hans J. Wegner, 1960

Table top in veneer as per original designed construction. Core of MDF. Edge in solid wood. Always mounted with plastic glides. Available in two heights, please specify height.

Modeldetails

0,15 m³ Packaging dimensions:
39 kg / 35,6 kg L: 153 / 51 cm W: 153 / 51 cm H:
5,5 / 6 cm

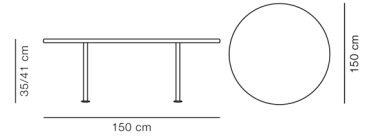

Essential Assortment

Item number	Surface	Frame	Height	Price
10251056013500	Oak oil treated	Brushed stainless steel	35 cm	3.795
10251056014100	Oak oil treated	Brushed stainless steel	41 cm	3.795
10251646013500	Walnut oil	Brushed stainless steel	35 cm	4.160
10251646014100	Walnut oil	Brushed stainless steel	41 cm	4.160

Order configuration

Height: 35 or 41 cm.

	Oak lacquered	Oak oil	Walnut oil
Stainless steel, brushed	3.935	3.795	4.160

Storage

Model 2921



BM29 Shelf

1 compartment, 2 shelves

Designed by Børge Mogensen, 1956

Rails and brackets are solid wood while the shelves are veneer. The shelves are mounted on the rails and brackets using screws. The rails are mounted to the wall with the keyhole fittings and screws. Brass screws for mounting of shelves to rails and to the wall is included. Rawplugs is not included as it depends on the specific type of wall.

Modeldetails

0,02 m³ Packaging dimensions:
9 kg / 7 kg L: 81 cm W: 27 cm H: 8 cm

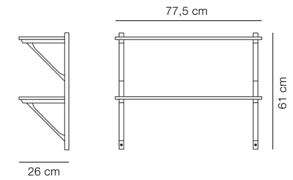

Essential Assortment

Item number	Surface	Price
29215129310400	Oak lacquer	1.060
29215129316200	Walnut lacquer	1.180

Max load capacity for the shelf is 10 kg per shelf, where the composition of the wall and the mounting of the module allow this. The weight should be distributed evenly.

Model 2901



BM29 Shelf

1 compartment, 3 shelves & desk shelf

Designed by Børge Mogensen, 1956

Rails and brackets are solid wood while the shelves are veneer. The shelves are mounted on the rails and brackets using screws. The rails are mounted to the wall with the keyhole fittings and screws. Brass screws for mounting of shelves to rails and to the wall is included. Rawplugs is not included as it depends on the specific type of wall.

Modeldetails

0,07 m³ Packaging dimensions:
16 kg / L: 137 cm W: 45 cm H: 11 cm
14 kg

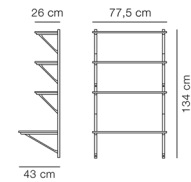

Essential Assortment

Item number	Surface	Price
29015329110400	Oak lacquer	2.005
29015329116200	Walnut lacquer	2.360

Max load capacity for the shelf is 10 kg per shelf, where the composition of the wall and the mounting of the module allow this. The weight should be distributed evenly.

Model 2920

BM29 Shelf 2 compartments, 2 shelves



Designed by Børge Mogensen, 1956

Rails and brackets are solid wood while the shelves are veneer. The shelves are mounted on the rails and brackets using screws. The rails are mounted to the wall with the keyhole fittings and screws. Brass screws for mounting of shelves to rails and to the wall is included. Rawplugs is not included as it depends on the specific type of wall.

Modeldetails

0,05 m³ Packaging dimensions:
13 kg / L: 156 cm W: 28 cm H: 11 cm
11 kg

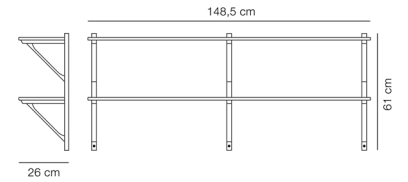

Essential Assortment

Item number	Surface	Price
29205229210400	Oak lacquer	1.655
29205229216200	Walnut lacquer	1.890

Max load capacity for the long shelves is 15 kg per shelf where the composition on the wall and the mounting of the module allow this. The weight should be distributed evenly.

Model 2900



BM29 Shelf

2 compartments, 3 shelves, desk shelf

Designed by Børge Mogensen, 1956

Rails and brackets are solid wood while the shelves are veneer. The shelves are mounted on the rails and brackets using screws. The rails are mounted to the wall with the keyhole fittings and screws. Brass screws for mounting of shelves to rails and to the wall is included. Rawplugs is not included as it depends on the specific type of wall.

Modeldetails

0,1 m³ Packaging dimensions:
26 kg / 24 kg L: 156 cm W: 45 cm H: 14 cm

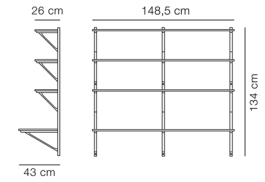

Essential Assortment

Item number	Surface	Price
29005429010400	Oak lacquer	2.955
29005429016200	Walnut lacquer	3.310

Max load capacity is 15 kg per long shelf where the composition of the wall and the mounting of the module allow this. The weight should be distributed evenly.

Complements

Model 5375

BM375 Nesting Tables



Designed by Børge Mogensen, 1962

Side table with base in solid wood and table top in veneer made with box-joints. A nest consists of 3 tables.

Modeldetails

0,13 m³ Packaging dimensions:
13 kg / 11 kg L: 50 cm W: 50 cm H: 52 cm

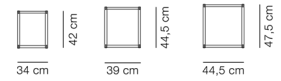

Essential Assortment

Item number	Wood	Description	Price
53752060337500	Oak light oil, FSC Mix 70%	Set of 3	945

Certifications

FSC® certified
EN 15372:2016 (L2)

Model 8110

Fellow Lamp Incl. light bulb G9 LED



Designed by Space Copenhagen, 2020

Base in solid limestone, detail fittings in solid brass. Shade in powder coated steel can turn a maximum of 150 degrees to each side from middle position. Black fabric 255 cm power cord with on/off switch and type C European power plug. Switch located 60 cm from the base. Light source G9 LED light bulb, 220-240 VAC, maximum 4.8W. Bulb included. IP-value: IP50. The lamp is delivered with felt glides glued on.

Modeldetails

0,05 m³ Packaging dimensions:
9 kg / 6,4 kg L: 45 cm W: 36 cm H: 33 cm

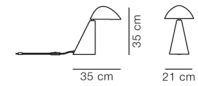

Essential Assortment

Item number	Lampshade	Base	Price
811052010380	White steel	Dark Atlantico Limestone	825

Only for sale in Europe.

Model 8115

Meadow Lamp Excl. light bulb E27



Designed by Space Copenhagen, 2020

Base in solid limestone, detail fittings in solid brass. Shade in mouth blown opal glass, white frosted. Black fabric 280 cm power cord with on/off switch and type C European power plug. Switch located 70 cm from the base. Light source socket is standard E27 and suitable for max. 112 mm light bulbs, voltage 220-240. LED bulbs recommended for lower energy consumption. IP-value: IP50. Bulb is not included. The lamp is delivered with felt glides glued on.

Modeldetails

0,06 m³ Packaging dimensions:
5,5 kg / 2,3 kg L: 45 cm W: 36 cm H: 37 cm

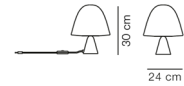

Essential Assortment

Item number	Lampshade	Base	Price
811552110381	White Opal glass	Dark Atlantico Limestone	610

Only for sale in Europe.

Model 1610

Gallery Stool



Designed by Hans Sandgren Jakobsen, 1998

Stool made from a single mould of plywood and fixed with metal joints.

Modeldetails

0,12 m³ Packaging dimensions:
6,1 kg / 4 kg L: 56 cm W: 41 cm H: 54 cm

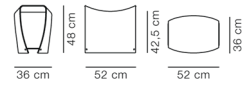

Essential Assortment

Item number	Wood	Price
1610223	Black ash, FSC Mix 70%	795
1610226	Walnut lacquer, FSC Mix 70%	795

Certifications

FSC® certified

Model 8210

Hydro Brass Vase

H: 20 cm



Designed by Sofie Østerby, 2020

Casted solid brass with black oxidised surface treatment. Waterproof. The brass surface acquires patina with use and outer surface should be kept dry to avoid blotches.

Modeldetails

0,01 m³ Packaging dimensions:
3 kg / L: 31 cm W: 31 cm H: 29 cm
2,8 kg

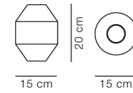

Essential Assortment

Item number	Material	Price
821010	Black-oxide brass	600

Model 8211

Hydro Brass Vase H: 30 cm



Designed by Sofie Østerby, 2020

Casted solid brass with black oxidised surface treatment. Waterproof. The brass surface acquires patina with use and outer surface should be kept dry to avoid blotches.

Modeldetails

0,03 m³ Packaging dimensions:
5,4 kg / 5 kg L: 31 cm W: 31 cm H: 39 cm

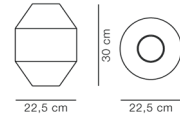

Essential Assortment

Item number	Material	Price
821110	Black-oxide brass	960

Model 8208

Hydro Glass Vase

H: 20 cm



Designed by Sofie Østerby, 2023

Mouthblown vase made from crystalline lead-free glass.

Modeldetails

0,01 m³ Packaging dimensions:
1,2 kg / L: 31 cm W: 31 cm H: 29 cm
0,9 kg

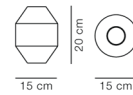

Essential Assortment

Item number	Material	Price
8208400	Glass	115

Model 8209

Hydro Glass Vase

H: 30 cm



Designed by Sofie Østerby, 2023

Mouthblown vase made from crystalline lead-free glass.

Modeldetails

0,03 m³

Packaging dimensions:

2,6 kg /
2,1 kg

L: 31 cm W: 31 cm H: 39 cm

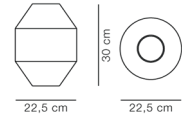

Essential Assortment

Item number	Material	Price
8209400	Glass	175

Model 8215

Locus Bowl Decorative bowl



Designed by Sofie Østerby, 2020

Solid travertine with drilled grooves outer finish. The travertine is natural and without resin fillings, which allows any natural spots or irregular openings in the surface to show. For decoration only. The bowl should be kept away from any acidic products, liquids and foods.

Modeldetails

0,02 m³ Packaging dimensions:
9,8 kg / 8,6 kg L: 48,5 cm W: 48,5 cm H: 15,3 cm

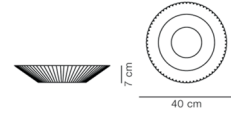

Essential Assortment

Item number	Material	Price
821530	Travertine	1.180

Made from raw travertine. Not suitable for food such as fruits.

Model 6565

JG Stool



Designed by Jørgen Gammelgaard, 1970

Folding stool with base in stainless steel with seat in leather or 100% linen canvas.
Leather seat has canvas backing. No glides available.

Modeldetails

0,02 m³ Packaging dimensions:
6,2 kg / 5,6 kg L: 76 cm W: 48 cm H: 5,5 cm

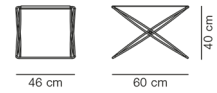

Essential Assortment

Item number	Seat	Frame	Price
65653160100	Natural canvas	Brushed stainless steel	720
65653460100	Leather Max 98, Black	Brushed stainless steel	960
65653560100	Leather Vegeta, Natural	Brushed stainless steel	960
65653360100	Leather Max 95, Cognac	Brushed stainless steel	960

Certifications

EN 1022:2005, EN 16139:2013 (L1)

Model 6500

Magazine Table Side table



Designed by Jens Risom, 1949

Three-legged side table. Base and table top in plywood.

Modeldetails

0,14 m³ Packaging dimensions:
6,1 kg / 4,6 kg L: 61 cm W: 44 cm H: 52 cm



Essential Assortment

Item number	Wood	Price
650020200	Oak lacquer FSC Mix 70%	540
650022500	Oak black lacquer, FSC Mix 70%	540

Certifications

FSC® certified

Model 1880



Nara Coat Stand

Designed by Shin Azumi, 2009

Coat stand made from solid wood, designed to utilise scrap wood from table production. Base of powder coated steel.

Modeldetails

0,27 m³ Packaging dimensions:
13 kg / 10 kg L: 34 cm W: 43 cm H: 186 cm

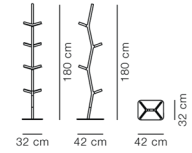

Essential Assortment

Item number	Wood	Base	Price
18802022	Oak lacquer FSC Mix 70%	White	765
18802231	Black ash, FSC Mix 70%	Black	765

Certifications

FSC® certified

Model 6830

Pioneer Stool, ht 46 cm



Designed by Maria Bruun, 2023

Stackable stool with a base in solid wood. Seat consists of an inner construction of a MDF core with HR or CMHR foam and upholstered with a removable fabric cover with zippers or non-removable cover in leather. Upholstered seat is removable. Metal screws and fittings. Mounted with plastic glides, felt glides are available.

Modeldetails

0,09 m³ Packaging dimensions:
7 kg / 4 kg L: 42 cm W: 42 cm H: 50 cm

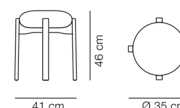

Essential Assortment

Item number	Upholstery	Frame	Price
6830002070854400	Hallingdal 200	Oak lacquer, FSC Mix 70%	590
6830002220855400	Hallingdal 370	Smoked oak stained lacquer, FSC Mix 70%	650
6830020390854400	Zero 0001	Oak lacquer, FSC Mix 70%	705
6830406280855400	Vidar 386	Smoked oak stained lacquer, FSC Mix 70%	705
6830508610855400	Leather Primo 86-1, Dark brown	Smoked oak stained lacquer, FSC Mix 70%	705
6830500900854400	Leather Vegeta 90, Natural	Oak lacquer, FSC Mix 70%	765

Essential variants are delivered with plastic glides and HR foam

Order configuration

	Beech black lacquered	Oak lacquered	Smoked oak stained, lacquered
Fabric group 1	590	650	705
Fabric group 2	620	680	735
Fabric group 3	645	705	760
Fabric group 4	690	755	810
Fabric group 5	785	845	905
C.O.M. fabric	590	650	705
Leather group 1	640	700	755
Leather group 2	665	725	780
Leather group 3	670	730	780
Leather group 4	725	780	835
Leather group 5	815	875	930
C.O.M. leather	640	700	755

Fabric consumption: 0,5 m. Leather consumption: 0,5 m²

Stackable: 6 pcs. on floor.

Certifications

FSC® certified

EN 1022:2005, EN 16139:2013 (L2)

Recommended upholstery

Fabric group 1	Linara, Bardal, Capture, Re-wool, Erik
Fabric group 2	Hallingdal, Barnum, Steelcut Trio, Fiord, Loop, Ruskin
Fabric group 3	Vidar, Clay, Sunniva, Divina Melange, Foss
Fabric group 4	Elle, Safire
Fabric group 5	Gentle
Leather group 1	Omni
Leather group 2	Primo, Trace
Leather group 3	Max
Leather group 4	Nubuck, Vegeta, Organic

Model 6402

Seto Stool



Designed by Keiji Takeuchi, 2023

Base in solid wood mounted with a non-removable seat in canvas finished with a leather cord. Glides in felt are included.

Modeldetails

0,09 m³ Packaging dimensions:
6 kg / L: 55 cm W: 37 cm H: 45 cm
5,2 kg

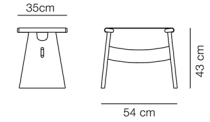

Essential Assortment

Item number	Seat	Frame	Price
64023085337	Black canvas	Oak black lacquer, FSC Mix 70%	705
64023185237	Natural canvas	Oak light oil - FSC Mix 70%	705

Certifications

FSC® certified
EN 1022:2005, EN 16139:2013 (L1)

Model 1756

Sequoia Pouf Ø40 cm



Designed by Space Copenhagen, 2020

Fully upholstered pouf with Inner shell in moulded polyurethane foam, CMHR or HR foam, reinforced with a steel frame and wooden base.
Upholstered in textile and mounted with plastic gliders, felt glides are available.

Modeldetails

0,1 m³ Packaging dimensions:
8 kg / L: 45 cm W: 45 cm H: 47 cm
6 kg

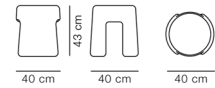

Essential Assortment

Item number	Upholstery	Price
175600481046	Barnum 24, Lana	780
175600205046	Hallingdal 65, 110	780
175649980046	Sheepskin Moonlight	1.085

Essential variants only delivered with HR foam

Order configuration

Fabric group 1	855
Fabric group 2	905
Fabric group 3	950
Fabric group 4	1.035
Fabric group 5	1.145
C.O.M. fabric	855
Sheepskin	1.085

Fabric consumption: 1,1 m

Recommended upholstery

Fabric group 1	Remix, Capture, Bardal, Re-wool, Linara, Grand Linen, Natural Linen, Erik
Fabric group 2	Hallingdal, Barnum, Loop, Steelcut Trio, Fiord, Ruskin
Fabric group 3	Divina Melange, Vidar, Sunniva, Foss, Clay
Fabric group 4	Elle, Sisu, Safire
Fabric group 5	Gentle

Model 8321

Silhouette Mirror Ø55 cm



Designed by OEO Studio, 2020

Mirror with frame in solid wood. 4 mm mirror glass. Back of black lacquered MDF. Wall suspension fittings of birch plywood included. Screws and rawlplugs for mounting not included. Caution: as solid wood reacts to damp or dry air, the mirror should not be placed in extreme indoor climate conditions.

Modeldetails

0,029 m³ Packaging dimensions:
7 kg / L: 69 cm W: 70 cm H: 6 cm
3,8 kg

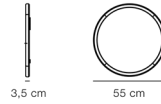

Essential Assortment

Item number	Frame	Price
832113	Oak light oil	590
832111	Walnut oil	705

Model 8320

Silhouette Mirror Ø100 cm

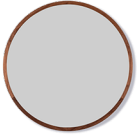

Designed by OEO Studio, 2020

Mirror with frame in solid wood. 4 mm mirror glass. Back of black lacquered MDF. Wall suspension fittings of birch plywood included. Screws and rawlplugs for mounting not included. Caution: as solid wood reacts to damp or dry air, the mirror should not be placed in extreme indoor climate conditions.

Modeldetails

0,08 m³ Packaging dimensions:
20 kg / 12 kg L: 114 cm W: 116 cm H: 6 cm

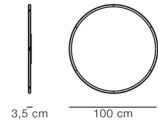

Essential Assortment

Item number	Frame	Price
832013	Oak light oil	1.060
832011	Walnut oil	1.180

Model 8322

Silhouette Mirror 70x70 cm



Designed by OEO Studio, 2020

Mirror with frame in solid wood. 4 mm mirror glass. Back of black lacquered MDF. Wall suspension fittings of birch plywood included. Screws and rawlplugs for mounting not included. Caution: as solid wood reacts to damp or dry air, the mirror should not be placed in extreme indoor climate conditions.

Modeldetails

0,04 m³ Packaging dimensions:
11 kg / 7 kg L: 82 cm W: 80 cm H: 6 cm

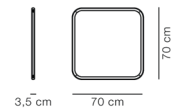

Essential Assortment

Item number	Frame	Price
832213	Oak light oil	885
832211	Walnut oil	1.000

Model 8324



Silhouette Mirror 70x180 cm

Designed by OEO Studio, 2020

Mirror with frame in solid wood. 4 mm mirror glass. Back of black lacquered MDF. Wall suspension fittings of birch plywood included. Screws and rawlplugs for mounting not included. Caution: as solid wood reacts to damp or dry air, the mirror should not be placed in extreme indoor climate conditions.

Modeldetails

0,09 m³ Packaging dimensions:
30 kg / 16 kg L: 191 cm W: 83 cm H: 7 cm

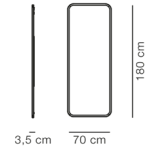

Essential Assortment

Item number	Frame	Price
832413	Oak light oil	1.415
832411	Walnut oil	1.535

**Model
F1090**

Fredericia Care Kits



Designed by Fredericia Furniture

All Fredericia Care Kits are packaged in a brown cardboard box and includes necessary cloths or sponges for one treatment. Instructions are enclosed and can also be downloaded through fredericia.com.

Order configuration

Wood oil	Wood light oil	Wood soap
35	35	35

Material Samples

All prices are excl. VAT and shipping costs

PRODUCT	SIZE	PRICE EUR
Sample kits		
Sample Box, full collection	275 x 315 x 110 mm	429
Sample Organizer, small	260 x 315 x 70 mm	221
Wall mounted hook for chairs, Oak lacquered		25
Fredericia logo block, black ash & white logo	25m x 83 mm	40
Leather sets		
Leather card	A4 fold-out	22
Saddle leather, set of 3 pcs	70 x 150 mm	15
Leather Hanger, Gr. 0+1	A5	67
Leather Hanger, Gr. 2	A5	67
Leather Hanger, Gr. 3	A5	98
Leather Hanger, Gr. 3+4	A5	98
Leather, single samples		
A5, Leather Gr. 0-2	A5	6
A5, Leather Gr. 3-4	A5	9
75x55mm, Leather Gr. 0-2	75x55mm	4
75x55mm Leather Gr. 3-4	75x55mm	4
Saddle leather	75x55mm	4
Sheepskin	75x55mm	4
Fabric, single samples		
Texture sample, standard fabrics*	75x55mm	3
Canvas & Linen webbing	75x55mm	2
Wood		
Wood Retail Display w. 10x10cm solid wood samples	360x130x60mm	280
Single wood sample, small	75x55mm	7
Single wood sample, large	100x100mm	11
Metal	75x55mm	4
Laminates / linoleum	75x55mm	5
Stone		
Stone Retail Display w. 10x10cm solid stone samples	360x130x60mm	251
Single graphic stone sample, small	75x55mm	4
Single solid stone sample, large	100x100mm	22
Pato Colours		
Pato Colour reference	75x55mm	4
Pato Polypropylene	60x100mm	5

*Available in one colour only

For other material & surface samples, please contact Customer Care & Quality at customerservice@fredericia.com

Fredericia Furniture A/S

Treldevej 183
7000 Fredericia

info@fredericia.com
+45 7592 3344

fredericia.com

