



Connected Spaces
Euro Price List 2020



SALES CONTACTS

Theis Johnson

Chief Sales Officer, Retail & Contract, Global
tjo@menuspace.com

Michael Thomann

Brand & Sales Manager, Retail & Contract, Central Europe
mth@menuspace.com

Steen Elkaer-Hansen

Brand & Sales Manager, Retail & Contract, ROW & APAC
sehs@menuspace.com

Patrick Fettan

Sales Executive, Retail, South Germany
pfe@menuspace.com

Judit Oberberger

Sales Executive, Contract, South Germany
juo@menuspace.com

Ricardo Feismann

Sales Executive, Retail, Middle Germany
rfe@menuspace.com

Michael Olivier Steiner

Sales Executive, Retail, North Germany
mos@menuspace.com

AGENTS**Ann Tradix**

Agent, Belgium
ann@tradix.be

Sarah Ribesse

Agent, Belgium
sarah@tradix.be

Clemens Hübschmann

Agent, Germany
ch@mood-rooms.de

Menu DR Diffusion

Agent, France
menu@drdiffusion.fr

Dirk Euler Ita

Agent, Switzerland
itadirkeuler@gmail.com

Fa Baltics

Agent, Lithuania
info@fabaltics.com

Felix Casa Contract

Agent, Spain
felix@cascontract.com

Isabella Nunes

Agent, Portugal
isabelanunes.brands@gmail.com

Standardcollection Info

Agent, Italy
info@standardcollection.it

Vera Living

Agent, Russia
vl@viving.dk

DISTRIBUTOR**Olga Rodantv**

Distributor, Poland
OlgaR@rodantv.pl

Press Enquiries

press@menuspace.com

www.menuspace.com

@menuspace

TABLE OF CONTENTS

PREFACE	4
MENU at The Audo	7
FURNITURE	
Harbour Collection	10
Co Chair Collection	102
Afterroom Collection	122
Tearoom Collection	174
Synnes Chair	186
Snaregade Table Collection	190
Knitting Chair	204
Plinth Collection	208
Androgyne Collection	212
Turning Table	220
Align Daybed	222
Eave Modular Sofa	224
Godot Sofa	236
Offset Sofa	240
Tailor Sofa	246
Zet Storing System	252
Stick System	254
WM String Chair	258
WM String Cushion	260
Septembre Lounge Table	262
NoNo Table	264
Rail Desk	266
Yeh Wall Table	268
Gravel Rug	270
Nimbus Mirror	272
Darkly Mirror	274
Pedal Bins	276
LIGHTING	
Bank Pendant	282
Franklin Chandelier	284
Harrison Chandelier	286
Leonard Chandelier	288
Chambers Chandelier Ø76	290
Chambers Chandelier Ø96	292

Hubert Pendant Ø24	294
Hubert Pendant Ø45	296
Hubert Suspension Frame	298
Walker Ceiling/Wall Lamp	300
Hudson Ceiling/Wall Lamp	302
Warren Wall Lamp	304
Staple Wall Lamp	306
TR Collection	308
JWDA Collection	330
Carrie LED Lamp	338
Circular Lamp	340
Task Pendant	342
Column Table Lamp	344
Cast Sconce Wall Lamp	346
Cast Pendant Shapes 1–3	348
Cast Pendant Shape 4	350
Stone Lamp	352
Phare LED Lamp	354
Peek Lamp	356
Dancing Pendant	358
Socket Occasional Lamp	360
Globe Bulb	362
Reverse Table Lamp	364
Hashira Collection	366
ACCESSORIES	
POV Collection	376
Échasse Collection	388
Aer Vase	394
Cyclades Vase	396
Willmann Vase	398
Troll Collection	400
Bottle Grinders	402
Bottle Collection	404
Stackable Glass	408
Kettle Teapot	410
Tea Heater	412
New Norm Dinnerware	414

Norm Thermo Cup	426
Norm Cutlery	428
Wire Planter	430
Pepe Marble Mirror	434
Kaschkasch Floor Mirror	436
Norm Mirror	438
Gridy Fungi Shelf	440
Norm Wire Bin	442
Ava Hanger	443
Afterroom Coat Hanger	444
Monument Magazine Holder	446
Marble Wall Clock	447
Duca Candleholder	448
Bath Collection	450
ADDENDUM	
Lead Times	462
Upholstery Programme	464
Sample Selection & Furniture Overview	476
MENU Swatch Box Pricelist	478
POS Overview	479
General Terms and Conditions	480
Materials & Maintenance	486
Variations in Natural Materials	494

For more than forty years, MENU has curated strong and lasting relations between designers, manufacturers and customers to create furniture, lighting and interior accessories shaped by purposeful details, high-quality materials and human needs. Designed to withstand the test of time, pieces are touched by our signature soft minimalism, pared back to reveal the very essence of each design. Enriching modern living through designs that connect individuals creatively, comfortably and functionally, our designs redefine how we use space at work, at home and at play and, ultimately, how we connect to one another. We call it *Connected Spaces*. On the following pages you will find a detailed compendium of the MENU 2020 furniture, lighting and accessories collections, including product options, material and size specifications as well as prices.

Eave Modular Sofa, Safire 0012, by Norm Architects
 Hashira Pendant, Cluster, Large, by Norm Architects
 Hashira Floor Lamp, by Norm Architects
 Knitting Chair, Dark Stained Oak / Dakar 0311, by Ib Kofod-Larsen
 Tearoom Lounge Chair, Deco Avorio T14035 001, by Nick Ross
 Androgyne Side Table, Ivory steel / Crystal Beige Rose, by Danielle Siggerud
 Plinth Low, Grey Kendzo Marble, by Norm Architects
 Gravel Rug, Ivory, by Nina Bruun
 Duca Candleholders, Polished Brass, by Krøyer-Sætter-Lassen





MENU at The Audo

COPENHAGEN

THE AUDO REFLECTS OUR PHILOSOPHY OF HUMAN CONNECTION, INSPIRATION AND EXPERIMENTATION THROUGH GREAT DESIGN. CONNECTING LIKEMINDED INDIVIDUALS THROUGH MEANINGFUL AND CREATIVE ENVIRONMENTS SHOWCASED IN UNCONVENTIONAL WAYS, IT TANGIBLY JOINS THE DOTS BETWEEN HOME, WORK AND HOSPITALITY.

MENU's showroom is located at The Audo, a unique concept that masterfully unites co-working and event facilities, a café, restaurant and retail area, as well as an exclusive residence in a single, community-building universe.

The Audo features an inspiring mix of original features and thoughtful new accompaniments from an eclectic mix of premium brands — not least MENU's comprehensive range of furniture, lighting and accessories which are put to their truest test together with a curated selection of products from global brands.

Abbreviated from the Latin *Ab Uno Disce Omnes*, meaning *from one, learn all*, The Audo reflects MENU's founding philosophy of collaborative spirit. Redefining how we use design, space and, ultimately, how we connect to one another, the creative destination is a hub for powerful ideas, beautiful design and inspiration.

Circular Lamp, Black Aluminum, by Studio WM
Harbour Column Dining Table, Ø80, Black Steel / Estremoz Marble, by Norm Architects
Tearoom Lounge Chair, Dedar Schwarzwald, by Nick Ross
Gravel Rug, Ivory, by Nina Bruun

1.

Furniture

Harbour Dining Chair

BY NORM ARCHITECTS

Dining chair with upholstered or bare shell set on a powder coated steel or solid oak base.



PRODUCT OPTIONS

SHELL

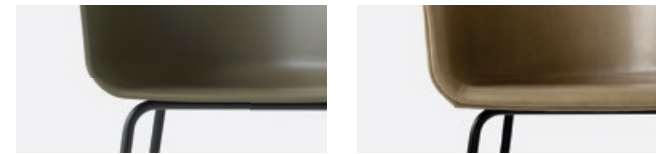

WITHOUT UPHOLSTERY

WITH UPHOLSTERY

SOLID OAK BASE

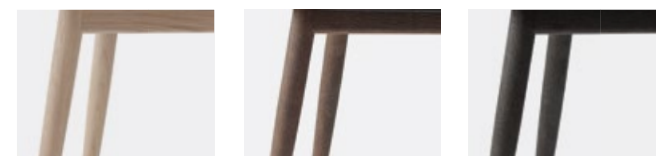

NATURAL OAK

DARK STAINED OAK

BLACK OAK

POWDER COATED STEEL BASE

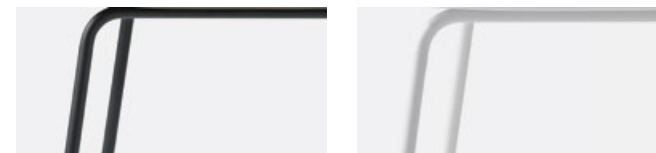

BLACK STEEL

LIGHT GREY STEEL

SPEC OPTIONS

Available in fabrics from our upholstery programme. Standard lead times apply. Custom upholstery available upon request. For further information please refer to MENU Upholstery Programme.

Harbour Dining Chair, Natural Oak / Dakar 0863, by Norm Architects
Harbour Dining Chair, Light Grey Steel / Remix 233, by Norm Architects

Harbour Dining Chair

BY NORM ARCHITECTS

TECHNICAL SPECIFICATIONS

PRODUCT TYPE
Dining chair

ENVIRONMENT
Indoor

DIMENSIONS

Steel base
H: 81 cm / 31,9"
SH: 45 cm / 17,7"
AH: 67,5 cm / 26,6"
D: 57 cm / 22,4"
W: 59 cm / 23,2"

Oak base
H: 81 cm / 31,9"
SH: 45 cm / 17,7"
AH: 67,5 cm / 26,6"
D: 57 cm / 22,4"
W: 59 cm / 23,2"

PRODUCTION PROCESS

The shell is made from injection moulded polypropylene with fibreglass. Steel bases are made from bent powder coated steel tubes. Wood bases are made using CNC laser-cut oak parts.

COLOUR

Shell without upholstery
Black (RAL 9011)
White (RAL 9016)
Light grey (RAL 9002)
Olive (RAL 7002)
Burned red (RAL 8015)
Khaki (RAL 1011)

Shell with upholstery
Dependent upon selected upholstery.

Steel base
Black (RAL 9005)
Light grey (RAL 9002)

Oak
Natural oak
Dark stained oak
Black oak

GLOSS
Gloss 10-20

MATERIALS

Shell
85% polypropylene, 15% fibreglass

Upholstered shell foam
CAL117 50 kg / 50N and 40 kg / 60N

Steel base
Powder coated steel

Oak base
Solid oak with matte lacquer, dark stained oak or black painted oak

WEIGHT
Steel base: 13 kg / 28,7 lb
Oak base: 12 kg / 26,5 lb

TEST

Steel base
EN1022:2005, L2
EN16139:2013, L2
ANSI: BIFMA X5.4

Oak base
EN1022:2005, L2
EN16139:2013, L2

CERTIFICATIONS
N / A

PACKAGING TYPE
Brown box

PACKAGING MEASUREMENTS (H x W x D)

Steel base
86 cm x 62 cm x 65 cm / 34" x 24,4" x 25,6"

Oak base
86 cm x 62 cm x 65 cm / 34" x 24,4" x 25,6"

MATERIALS & MAINTENANCE
Please see page 486 for materials and care and maintenance instructions.

HARBOUR DINING CHAIR, STEEL BASE

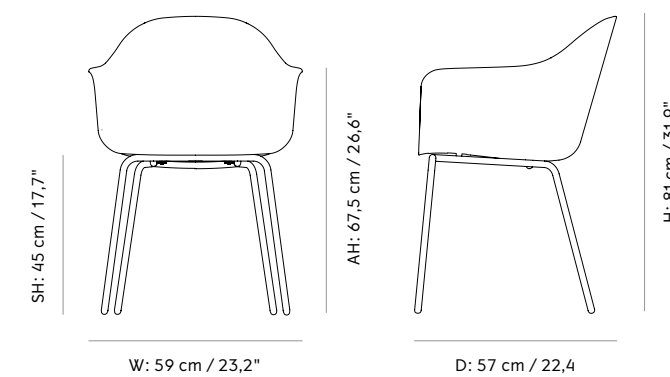



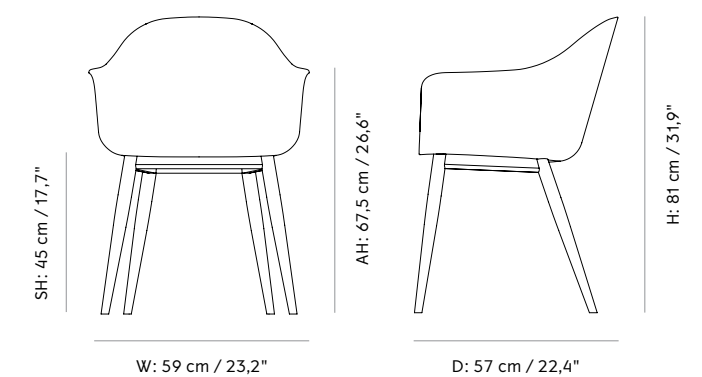









HARBOUR DINING CHAIR, SOLID OAK BASE



Harbour Dining Chair

BY NORM ARCHITECTS













QUICK SHIP OPTIONS — PRICES IN EUR *Selected combinations up to 4 weeks delivery time.*

SKU	VARIANT	INCL. VAT	EXCL. VAT
Shell without upholstery — Powder coated steel base — Black steel			
300200	 HARBOUR DINING CHAIR, BLACK STEEL / BURNED RED	279,95	234,26
300230	 HARBOUR DINING CHAIR, BLACK STEEL / OLIVE	279,95	234,26
300210	 HARBOUR DINING CHAIR, BLACK STEEL / KHAKI	279,95	234,26
300190	 HARBOUR DINING CHAIR, BLACK STEEL / WHITE	279,95	234,26
300220	 HARBOUR DINING CHAIR, BLACK STEEL / LIGHT GREY	279,95	234,26
9361000	 HARBOUR DINING CHAIR, BLACK STEEL / BLACK	279,95	234,26
Shell without upholstery — Powder coated steel base — Light grey steel			
300140	 HARBOUR DINING CHAIR, LIGHT GREY STEEL / BURNED RED	279,95	234,26
300170	 HARBOUR DINING CHAIR, LIGHT GREY STEEL / OLIVE	279,95	234,26
300150	 HARBOUR DINING CHAIR, LIGHT GREY STEEL / KHAKI	279,95	234,26
300130	 HARBOUR DINING CHAIR, LIGHT GREY STEEL / WHITE	279,95	234,26
300160	 HARBOUR DINING CHAIR, LIGHT GREY STEEL / LIGHT GREY	279,95	234,26
300120	 HARBOUR DINING CHAIR, LIGHT GREY STEEL / BLACK	279,95	234,26

Harbour Dining Chair

BY NORM ARCHITECTS



QUICK SHIP OPTIONS — PRICES IN EUR *Selected combinations up to 4 weeks delivery time.*

SKU	VARIANT	INCL. VAT	EXCL. VAT
Shell without upholstery — Solid oak base — Natural oak			
300070	 HARBOUR DINING CHAIR, NATURAL OAK / BURNED RED	349,95	292,84
300100	 HARBOUR DINING CHAIR, NATURAL OAK / OLIVE	349,95	292,84
300080	 HARBOUR DINING CHAIR, NATURAL OAK / KHAKI	349,95	292,84
9362000	 HARBOUR DINING CHAIR, NATURAL OAK / WHITE	349,95	292,84
300090	 HARBOUR DINING CHAIR, NATURAL OAK / LIGHT GREY	349,95	292,84
300060	 HARBOUR DINING CHAIR, NATURAL OAK / BLACK	349,95	292,84
Shell without upholstery — Solid oak base — Dark stained oak			
300020	 HARBOUR DINING CHAIR, DARK STAINED OAK / BURNED RED	349,95	292,84
300050	 HARBOUR DINING CHAIR, DARK STAINED OAK / OLIVE	349,95	292,84
300030	 HARBOUR DINING CHAIR, DARK STAINED OAK / KHAKI	349,95	292,84
300010	 HARBOUR DINING CHAIR, DARK STAINED OAK / WHITE	349,95	292,84
300040	 HARBOUR DINING CHAIR, DARK STAINED OAK / LIGHT GREY	349,95	292,84
300000	 HARBOUR DINING CHAIR, DARK STAINED OAK / BLACK	349,95	292,84

Harbour Dining Chair

BY NORM ARCHITECTS

QUICK SHIP OPTIONS — PRICES IN EUR *Selected combinations up to 4 weeks delivery time.*











SKU	VARIANT	INCL. VAT	EXCL. VAT
Shell with upholstery — Solid oak base — Natural oak / Dark stained oak			
9378049	 HARBOUR DINING CHAIR, DARK STAINED OAK / REMIX 233	649,95	543,88
9358819	 HARBOUR DINING CHAIR, DARK STAINED OAK / CITY VELVET CA 7832/060	649,95	543,88
9350979	 HARBOUR DINING CHAIR, NATURAL OAK / DAKAR 0250	979,95	820,02

Additional charge of 10% for CMHR foam in accordance with UK requirement.
Option to upholster with customer's own fabric available upon request. For further information please see our upholstery programme on page 464.

Harbour Dining Chair

BY NORM ARCHITECTS

RECOMMENDED COMBINATIONS — PRICES IN EUR *Selected combinations 6–8 weeks delivery time.*

SKU	VARIANT	INCL. VAT	EXCL. VAT
Shell with upholstery — Powder coated steel base — Black steel / Light grey steel			
300180	 HARBOUR DINING CHAIR, LIGHT GREY STEEL / REMIX 233	599,95	502,04
300240	 HARBOUR DINING CHAIR, BLACK STEEL / REMIX 233	599,95	502,04
9355159	 HARBOUR DINING CHAIR, BLACK STEEL / HOT MADISON CHI 249/988	599,95	502,04
9355939	 HARBOUR DINING CHAIR, BLACK STEEL / COLLINE 568	749,95	627,56
9355559	 HARBOUR DINING CHAIR, BLACK STEEL / DAKAR 0842	899,95	753,08
Shell with upholstery — Solid oak base — Natural oak / Dark stained oak / Black oak			
300110	 HARBOUR DINING CHAIR, NATURAL OAK / REMIX 233	649,95	543,88
9350989	 HARBOUR DINING CHAIR, NATURAL OAK / CITY VELVET CA 7832/078	649,95	543,88
9354469	 HARBOUR DINING CHAIR, BLACK OAK / CITY VELVET CA 7832/031	649,95	543,88
9350139	 HARBOUR DINING CHAIR, NATURAL OAK / HALLINGDAL 65, 130	819,95	686,13
400276	 HARBOUR DINING CHAIR, DARK STAINED OAK / GRISAILLE 004	1.399,95	1.171,48
9358559	 HARBOUR DINING CHAIR, DARK STAINED OAK / DAKAR 0842	979,95	820,02

Additional charge of 10% for CMHR foam in accordance with UK requirement.
Option to upholster with customer's own fabric available upon request. For further information please see our upholstery programme on page 464.

Harbour Dining Chair

BY NORM ARCHITECTS

SPEC OPTIONS — PRICES IN EUR *Selected combinations 6–8 weeks delivery time.*

SKU	VARIANT	INCL. VAT	EXCL. VAT
Textile — Shell with upholstery — Powder coated steel base — Black steel / Light grey steel			
9341001	PRICE CATEGORY 1 Maple, Kvadrat / Remix 2, Kvadrat / City Velvet, JAB / Hot Madison Reloaded, JAB / Gaja C2C, Gabriel / Champion, Kvadrat	599,95	502,04
9341002	PRICE CATEGORY 2 Hallingdal 65, Kvadrat / Savanna, Kvadrat / Colline, Kvadrat / Canvas, Kvadrat / Ritz, Nevotex / Fiord, Kvadrat / Steelcut 2, Kvadrat / Steelcut Trio 3, Kvadrat / Moss, Kvadrat / Clay, Kvadrat / Divina Melange, Kvadrat	749,95	627,56
9341003	PRICE CATEGORY 3 Vintage, Astrid / Safire, Kvadrat / Satoriale Collection: Grisaille, Dedar / Ponpon, Dedar	929,95	778,18
9341008	PRICE CATEGORY 4 (NEW) Satoriale Collection: Doppioanama, Dedar / Deco, Dedar Texturologie Collection: Lupo, Dedar / Atlas, Dedar	989,95	828,39
Leather — Shell with upholstery — Powder coated steel base — Black steel / Light grey steel			
9341004	PRICE CATEGORY 1 Ultra, Sørensen Leather / Dakar, Nevotex	899,95	753,08
9341005	PRICE CATEGORY 2 Dunes, Sørensen Leather / Shade, Sørensen Leather / Nuance, Sørensen Leather / Instill, Kvadrat	1.049,95	878,60
9341006	PRICE CATEGORY 3 Royal Nubuck, Sørensen Leather	1.289,95	1.079,43
9341007	PRICE CATEGORY 4 Elegance, Sørensen Leather	1.799,95	1.506,20

Additional charge of 10% for CMHR foam in accordance with UK requirement.
Option to upholster with customer's own fabric available upon request. For further information please see our upholstery programme on page 464.

Harbour Dining Chair

BY NORM ARCHITECTS

SPEC OPTIONS — PRICES IN EUR *Selected combinations 6–8 weeks delivery time.*

SKU	VARIANT	INCL. VAT	EXCL. VAT
Textile — Shell with upholstery — Solid oak base — Natural oak / Dark stained oak / Black oak			
9352001	PRICE CATEGORY 1 Maple, Kvadrat / Remix 2, Kvadrat / City Velvet, JAB / Hot Madison Reloaded, JAB / Gaja C2C, Gabriel / Champion, Kvadrat	649,95	543,88
9352002	PRICE CATEGORY 2 Hallingdal 65, Kvadrat / Savanna, Kvadrat / Colline, Kvadrat / Canvas, Kvadrat / Ritz, Nevotex / Fiord, Kvadrat / Steelcut 2, Kvadrat / Steelcut Trio 3, Kvadrat / Moss, Kvadrat / Clay, Kvadrat / Divina Melange, Kvadrat	819,95	686,13
9352003	PRICE CATEGORY 3 Vintage, Astrid / Safire, Kvadrat / Satoriale Collection: Grisaille, Dedar / Ponpon, Dedar	1.009,95	845,13
9352008	PRICE CATEGORY 4 (NEW) Satoriale Collection: Doppioanama, Dedar / Deco, Dedar Texturologie Collection: Lupo, Dedar / Atlas, Dedar	1.079,95	903,70
Leather — Shell with upholstery — Solid oak base — Natural oak / Dark stained oak / Black oak			
9352004	PRICE CATEGORY 1 Ultra, Sørensen Leather / Dakar, Nevotex	979,95	820,02
9352005	PRICE CATEGORY 2 Dunes, Sørensen Leather / Shade, Sørensen Leather / Nuance, Sørensen Leather / Instill, Kvadrat	1.139,95	953,91
9352006	PRICE CATEGORY 3 Royal Nubuck, Sørensen Leather	1.399,95	1.171,48
9352007	PRICE CATEGORY 4 Elegance, Sørensen Leather	1.949,95	1.631,72
Shell without upholstery — Oak wood base — Black oak			
9350639	Black oak / any shell	349,95	292,84

Additional charge of 10% for CMHR foam in accordance with UK requirement.
Option to upholster with customer's own fabric available upon request. For further information please see our upholstery programme on page 464.

Harbour Side Dining Chair

BY NORM ARCHITECTS

Dining chair with upholstered or bare shell set on a powder coated steel or solid oak base.



PRODUCT OPTIONS

SHELL

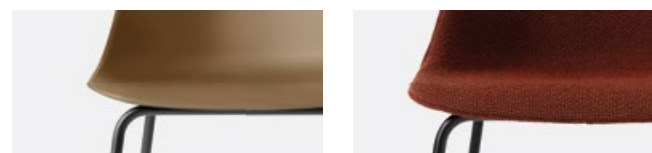

WITHOUT UPHOLSTERY

WITH UPHOLSTERY

SOLID OAK BASE

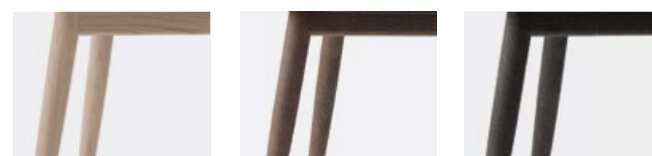

NATURAL OAK

DARK STAINED OAK

BLACK OAK

POWDER COATED STEEL BASE



BLACK STEEL

LIGHT GREY STEEL

SPEC OPTIONS

Available in fabrics from our upholstery programme. Standard lead times apply. Custom upholstery available upon request. For further information please refer to MENU Upholstery Programme.

Harbour Side Dining Chair, Black Steel / Khaki, by Norm Architects
 Harbour Side Dining Chair, Black Steel / Burned Red, by Norm Architects
 Harbour Side Dining Chair, Black Steel / Light Grey, by Norm Architects

Harbour Side Dining Chair

BY NORM ARCHITECTS

TECHNICAL SPECIFICATIONS

PRODUCT TYPE

Dining chair

ENVIRONMENT

Indoor

DIMENSIONS

Steel base

H: 81 cm / 31,9"
 SH: 45 cm / 17,7"
 D: 56 cm / 22"
 W: 52 cm / 20,5"

Oak base

H: 81 cm / 31,9"
 SH: 45 cm / 17,7"
 D: 57 cm / 22,4"
 W: 50 cm / 19,7"

PRODUCTION PROCESS

The shell is made from injection moulded polypropylene with fibreglass. Steel bases are made from bent powder coated steel tubes. Wood bases are made using CNC laser-cut oak parts.

COLOUR

Shell without upholstery

Black (RAL 9011)
 White (RAL 9016)
 Light grey (RAL 9002)
 Olive (RAL 7002)
 Burned red (RAL 8015)
 Khaki (RAL 1011)

Shell with upholstery

Dependent upon selected upholstery.

Steel base

Black (RAL 9005)
 Light Grey (RAL 9002)

Oak base

Natural oak
 Dark stained oak
 Black oak

GLOSS

Gloss 10-20

MATERIALS

SShell

85% polypropylene, 15% fibreglass

Upholstered shell foam

CAL117 50 kg / 50N and 40 kg / 60N

Steel base

Powder coated steel

Oak base

Solid oak with matte lacquer, dark stained oak or black painted oak

WEIGHT

Steel base: 12 kg / 26,5 lb
 Oak base: 11 kg / 24,3 lb

TEST

EN1022:2005, L2
 EN16139:2013, L2

CERTIFICATIONS

N / A

PACKAGING TYPE

Brown box

PACKAGING MEASUREMENTS (H x W x D)

Steel base

86 cm x 62 cm x 65 cm / 34" x 24,4" x 25,6"

Oak base

86 cm x 62 cm x 65 cm / 34" x 24,4" x 25,6"

MATERIALS & MAINTENANCE

Please see page 486 for materials and care and maintenance instructions.

HARBOUR DINING SIDE CHAIR, STEEL BASE

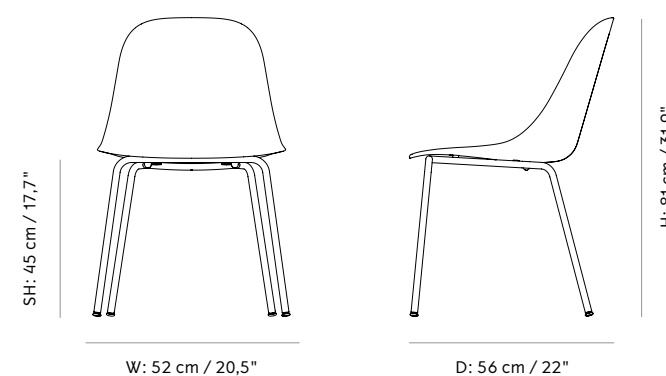



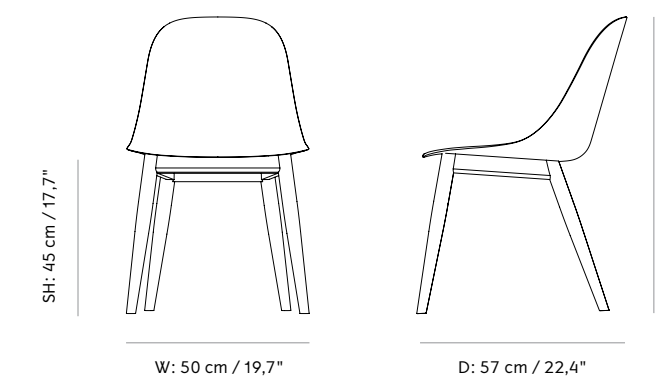





HARBOUR DINING SIDE CHAIR, SOLID OAK BASE



Harbour Side Dining Chair

BY NORM ARCHITECTS

QUICK SHIP OPTIONS — PRICES IN EUR *Selected combinations up to 4 weeks delivery time.*









SKU	VARIANT	INCL. VAT	EXCL. VAT
Shell without upholstery — Powder coated steel ase — Black steel / Light grey steel			
9275849	 HARBOUR SIDE DINING CHAIR, BLACK STEEL / KHAKI	239,95	200,79
9271139	 HARBOUR SIDE DINING CHAIR, LIGHT GREY STEEL / LIGHT GREY	239,95	200,79
9275539	 HARBOUR SIDE DINING CHAIR, BLACK STEEL / BLACK	239,95	200,79
Shell without upholstery — Solid oak base — Natural oak/ Dark stained oak			
9270349	 HARBOUR SIDE DINING CHAIR, NATURAL OAK / BURNED RED	279,95	234,26
9278429	 HARBOUR SIDE DINING CHAIR, DARK STAINED OAK / OLIVE	279,95	234,26
9270639	 HARBOUR SIDE DINING CHAIR, NATURAL OAK / WHITE	279,95	234,26
Shell with upholstery — Solid oak base — Natural oak / Dark stained oak			
9278819	 HARBOUR SIDE DINING CHAIR, DARK STAINED OAK / CITY VELVET CA7832/060	499,95	418,36
9278049	 HARBOUR SIDE DINING CHAIR, DARK STAINED OAK / REMIX 2, 233	499,95	418,36
9270979	 HARBOUR SIDE DINING CHAIR, NATURAL OAK / DAKAR 0250	749,95	627,56

Additional charge of 10% for CMHR foam in accordance with UK requirement.
Option to upholster with customer's own fabric available upon request. For further information please see our upholstery programme on page 464.

Harbour Side Dining Chair

BY NORM ARCHITECTS

RECOMMENDED COMBINATIONS — PRICES IN EUR *Selected combinations 6–8 weeks delivery time.*

SKU	VARIANT	INCL. VAT	EXCL. VAT
Shell with upholstery — Powder coated steel base — Black steel			
9275159	 HARBOUR SIDE DINING CHAIR, BLACK STEEL / HOT MADISON CHI 249/988	499,95	418,36
9275939	 HARBOUR SIDE DINING CHAIR, BLACK STEEL / COLLINE 568	629,95	527,14
9275559	 HARBOUR SIDE DINING CHAIR, BLACK STEEL / DAKAR 0842	749,95	627,56
Shell with upholstery — Solid oak base — Natural oak / Dark stained oak / Black oak			
9270989	 HARBOUR SIDE DINING CHAIR, NATURAL OAK / CITY VELVET CA7832/078	499,95	418,36
9274469	 HARBOUR SIDE DINING CHAIR, BLACK OAK / CITY VELVET CA7832/031	499,95	418,36
9270139	 HARBOUR SIDE DINING CHAIR, NATURAL OAK / HALLINGDAL 65, 130	629,95	527,14
9278589	 HARBOUR SIDE DINING CHAIR, DARK STAINED OAK / GRISAILLE 004	779,95	652,66
9278169	 HARBOUR SIDE DINING CHAIR, DARK STAINED OAK / DAKAR 0311	749,95	627,56

Additional charge of 10% for CMHR foam in accordance with UK requirement.
Option to upholster with customer's own fabric available upon request. For further information please see our upholstery programme on page 464.

Harbour Side Dining Chair

BY NORM ARCHITECTS

SPEC OPTIONS — PRICES IN EUR *Selected combinations 6–8 weeks delivery time.*

SKU	VARIANT	INCL. VAT	EXCL. VAT
Textile — Shell with upholstery — Powder coated steel base — Black steel / Light grey steel			
9394001	PRICE CATEGORY 1 Maple, Kvadrat / Remix 2, Kvadrat / City Velvet, JAB / Hot Madison Reloaded, JAB / Gaja C2C, Gabriel / Champion, Kvadrat	499,95	418,36
9394002	PRICE CATEGORY 2 Hallingdal 65, Kvadrat / Savanna, Kvadrat / Colline, Kvadrat / Canvas, Kvadrat / Ritz, Nevotex / Fiord, Kvadrat / Steelcut 2, Kvadrat / Steelcut Trio 3, Kvadrat / Moss, Kvadrat / Clay, Kvadrat / Divina Melange, Kvadrat	629,95	527,14
9394003	PRICE CATEGORY 3 Vintage, Astrid / Safire, Kvadrat / Satoriale Collection: Grisaille, Dedar / Ponpon, Dedar	779,95	652,66
9394008	PRICE CATEGORY 4 (NEW) Satoriale Collection: Doppioanama, Dedar / Deco, Dedar Texturologie Collection: Lupo, Dedar / Atlas, Dedar	829,95	694,50
Leather — Shell with upholstery — Powder coated steel base — Black steel / Light grey steel			
9394004	PRICE CATEGORY 1 Ultra, Sørensen Leather / Dakar, Nevotex	749,95	627,56
9394005	PRICE CATEGORY 2 Dunes, Sørensen Leather / Shade, Sørensen Leather / Nuance, Sørensen Leather / Instill, Kvadrat	879,95	736,34
9394006	PRICE CATEGORY 3 Royal Nubuck, Sørensen Leather	1.079,95	903,70
9394007	PRICE CATEGORY 4 Elegance, Sørensen Leather	1.499,95	1.255,16
Shell without upholstery — Powder coated steel base — Black steel / Light grey steel			
9394939	Any steel base / any shell	239,95	200,79

Additional charge of 10% for CMHR foam in accordance with UK requirement.
Option to upholster with customer's own fabric available upon request. For further information please see our upholstery programme on page 464.

Harbour Side Dining Chair

BY NORM ARCHITECTS

SPEC OPTIONS — PRICES IN EUR *Selected combinations 6–8 weeks delivery time.*

SKU	VARIANT	INCL. VAT	EXCL. VAT
Textile — Shell with upholstery — Solid oak base — Natural oak / Dark stained oak / Black oak			
9395001	PRICE CATEGORY 1 Maple, Kvadrat / Remix 2, Kvadrat / City Velvet, JAB / Hot Madison Reloaded, JAB / Gaja C2C, Gabriel / Champion, Kvadrat	499,95	418,36
9395002	PRICE CATEGORY 2 Hallingdal 65, Kvadrat / Savanna, Kvadrat / Colline, Kvadrat / Canvas, Kvadrat / Ritz, Nevotex / Fiord, Kvadrat / Steelcut 2, Kvadrat / Steelcut Trio 3, Kvadrat / Moss, Kvadrat / Clay, Kvadrat / Divina Melange, Kvadrat	629,95	527,14
9395003	PRICE CATEGORY 3 Vintage, Astrid / Safire, Kvadrat / Satoriale Collection: Grisaille, Dedar / Ponpon, Dedar	779,95	652,66
9395008	PRICE CATEGORY 4 (NEW) Satoriale Collection: Doppioanama, Dedar / Deco, Dedar Texturologie Collection: Lupo, Dedar / Atlas, Dedar	829,95	694,50
Leather — Shell with upholstery — Solid oak base — Natural oak / Dark stained oak / Black oak			
9395004	PRICE CATEGORY 1 Ultra, Sørensen Leather / Dakar, Nevotex	749,95	627,56
9395005	PRICE CATEGORY 2 Dunes, Sørensen Leather / Shade, Sørensen Leather / Nuance, Sørensen Leather / Instill, Kvadrat	879,95	736,34
9395006	PRICE CATEGORY 3 Royal Nubuck, Sørensen Leather	1.079,95	903,70
9395007	PRICE CATEGORY 4 Elegance, Sørensen Leather	1.499,95	1.255,16
Shell without upholstery — Solid oak base — Natural oak / Dark stained oak / Black oak			
9394839	Any wood base / any shell	279,95	234,26

Additional charge of 10% for CMHR foam in accordance with UK requirement.
Option to upholster with customer's own fabric available upon request. For further information please see our upholstery programme on page 464.

Harbour Dining Chair, Star Base w/Swivel

BY NORM ARCHITECTS

Dining chair with upholstered or bare shell set on a polished aluminium or black powder coated aluminium star base with swivel.



PRODUCT OPTIONS

SHELL

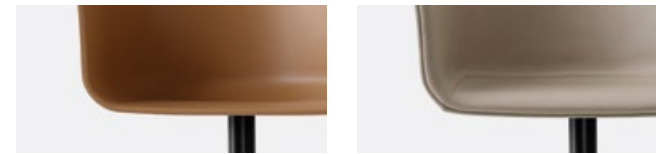

WITHOUT UPHOLSTERY

WITH UPHOLSTERY

STAR BASE

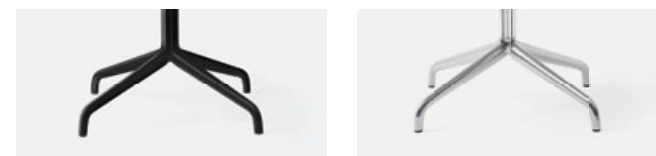

BLACK STEEL

POLISHED ALUMINIUM

SPEC OPTIONS

Available in fabrics from our upholstery programme. Standard lead times apply. Custom upholstery available upon request. For further information please refer to MENU Upholstery Programme.

Harbour Dining Chair, Star Base w/Swivel, Polished Aluminium / Nuance 40782, by Norm Architects

Harbour Dining Chair, Star Base w/Swivel

BY NORM ARCHITECTS

TECHNICAL SPECIFICATIONS

PRODUCT TYPE
Dining chair

ENVIRONMENT
Indoor

DIMENSIONS

Star base
H: 81 cm / 31,9"
SH: 45 cm / 17,7"
AH: 67,5 cm / 26,6"
D: 59 cm / 23,2"
W: 59 cm / 23,2"

PRODUCTION PROCESS

The shell is made using injection moulded polypropylene with fibreglass. The star base is die-cast and the column is made of extruded aluminium.

COLOUR

Base
Black (RAL 9005)
Polished aluminium

Shell without upholstery

Burned red (RAL 8015)
Olive (RAL 7002)
Khaki (RAL 1011)
White (RAL 9016)
Light grey (RAL 9002)
Black (RAL 9011)

Shell with upholstery

Dependent upon selected upholstery.

GLOSS

Gloss 10-20

MATERIALS

Shell
85% polypropylene, 15% fibreglass

Upholstered shell foam
CAL117 50 kg / 50N and 40 kg / 60N

Star base
Cast, extruded aluminium.

WEIGHT
13 kg / 28,7 lb

TEST
EN1022:2005, L2
EN16139:2013, L2

CERTIFICATIONS
N / A

PACKAGING TYPE
Brown box

PACKAGING MEASUREMENTS (H x W x D)
86 cm x 62 cm x 65 cm / 34" x 24,4" x 25,6"



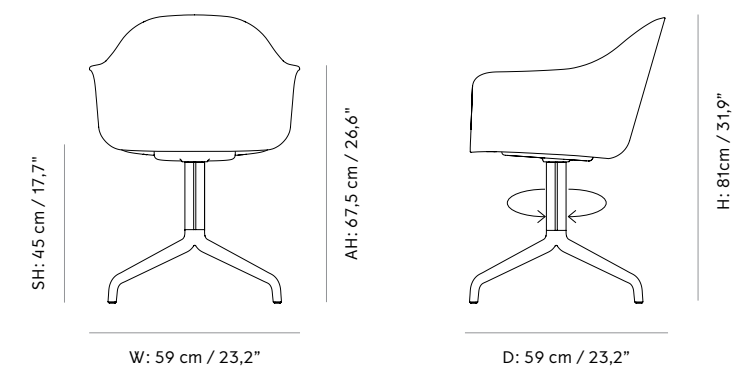

MATERIALS & MAINTENANCE
Please see page 486 for materials and care and maintenance instructions.



Harbour Dining Chair, Star Base w/Swivel

BY NORM ARCHITECTS

QUICK SHIP OPTIONS — PRICES IN EUR *Selected combinations up to 4 weeks delivery time.*











SKU	VARIANT	INCL. VAT	EXCL. VAT
Shell without upholstery — Star base — Black steel			
9375349	 HARBOUR DINING CHAIR, STAR BASE W/SWIVEL, BLACK STEEL / BURNED RED	629,95	527,14
9375429	 HARBOUR DINING CHAIR, STAR BASE W/SWIVEL, BLACK STEEL / OLIVE	629,95	527,14
9375849	 HARBOUR DINING CHAIR, STAR BASE W/SWIVEL, BLACK STEEL / KHAKI	629,95	527,14
9375539	 HARBOUR DINING CHAIR, STAR BASE W/SWIVEL, BLACK STEEL /BLACK	629,95	527,14
Shell without upholstery — Star base — Polished aluminium			
9370639	 HARBOUR DINING CHAIR, STAR BASE W/SWIVEL, POLISHED ALUMINIUM / WHITE	629,95	527,14

Additional charge of 10% for CMHR foam in accordance with UK requirement.
Option to upholster with customer's own fabric available upon request. For further information please see our upholstery programme on page 464.

Harbour Dining Chair, Star Base w/Swivel

BY NORM ARCHITECTS

RECOMMENDED COMBINATIONS — PRICES IN EUR *Selected combinations 6–8 weeks delivery time.*

SKU	VARIANT	INCL. VAT	EXCL. VAT
Shell with upholstery — Star base — Black steel			
9375939	 HARBOUR DINING CHAIR, STAR BASE W/SWIVEL, BLACK STEEL / COLLINE 568	1.069,95	895,33
9375969	 HARBOUR DINING CHAIR, STAR BASE W/SWIVEL, BLACK STEEL / HALLINGDAL 65 -0270	1.069,95	895,33
9375559	 HARBOUR DINING CHAIR, STAR BASE W/SWIVEL, BLACK STEEL / DAKAR 0842	1.279,95	1.071,06
9375159	 HARBOUR DINING CHAIR, STAR BASE W/SWIVEL, BLACK STEEL / NUANCE 40782	1.489,95	1.246,79
9356169	 HARBOUR DINING CHAIR, STAR BASE W/SWIVEL, BLACK STEEL / DAKAR 0311	1.279,95	1.071,06
Shell with upholstery — Star base — Polished aluminium			
9370939	 HARBOUR DINING CHAIR, STAR BASE W/SWIVEL, POLISHED ALUMINIUM / COLLINE 568	1.069,95	895,33
9370969	 HARBOUR DINING CHAIR, STAR BASE W/SWIVEL, POLISHED ALUMINIUM / HALLINGDAL 65-0270	1.069,95	895,33
9370559	 HARBOUR DINING CHAIR, STAR BASE W/SWIVEL, POLISHED ALUMINIUM / DAKAR 0842	1.279,95	1.071,06
9357979	 HARBOUR DINING CHAIR, STAR BASE W/SWIVEL, POLISHED ALUMINIUM / DAKAR 0250	1.279,95	1.071,06
9370159	 HARBOUR DINING CHAIR, STAR BASE W/SWIVEL, POLISHED ALUMINIUM / NUANCE 40782	1.489,95	1.246,79

Additional charge of 10% for CMHR foam in accordance with UK requirement.
Option to upholster with customer's own fabric available upon request. For further information please see our upholstery programme on page 464.

Harbour Dining Chair, Star Base w/Swivel

BY NORM ARCHITECTS

SPEC OPTIONS — PRICES IN EUR *Selected combinations 6–8 weeks delivery time.*

SKU	VARIANT	INCL. VAT	EXCL. VAT
Textile — Shell with upholstery — Star base — Black steel / Polished aluminium			
9371001	PRICE CATEGORY 1 Maple, Kvadrat / Remix 2, Kvadrat / City Velvet, JAB / Hot Madison Reloaded, JAB / Gaja C2C, Gabriel / Champion, Kvadrat	849,95	711,24
9371002	PRICE CATEGORY 2 Hallingdal 65, Kvadrat / Savanna, Kvadrat / Colline, Kvadrat / Canvas, Kvadrat / Ritz, Nevotex / Fiord, Kvadrat / Steelcut 2, Kvadrat / Steelcut Trio 3, Kvadrat / Moss, Kvadrat / Clay, Kvadrat / Divina Melange, Kvadrat	1.069,95	895,33
9371003	PRICE CATEGORY 3 Vintage, Astrid / Safire, Kvadrat / Satoriale Collection: Grisaille, Dedar / Ponpon, Dedar	1.319,95	1.104,53
9371008	PRICE CATEGORY 4 (NEW) Satoriale Collection: Doppiopanama, Dedar / Deco, Dedar Texturologie Collection: Lupo, Dedar / Atlas, Dedar	1.409,95	1.179,85
Leather — Shell with upholstery — Star base — Black steel / Polished aluminium			
9371004	PRICE CATEGORY 1 Ultra, Sørensen Leather / Dakar, Nevotex	1.279,95	1.071,06
9371005	PRICE CATEGORY 2 Dunes, Sørensen Leather / Shade, Sørensen Leather / Nuance, Sørensen Leather / Instill, Kvadrat	1.489,95	1.246,79
9371006	PRICE CATEGORY 3 Royal Nubuck, Sørensen Leather	1.829,95	1.531,30
9371007	PRICE CATEGORY 4 Elegance, Sørensen Leather	2.549,95	2.133,80
Shell without upholstery — Powder coated steel base — Black steel / Polished aluminium			
9370000	Any star base with swivel and Shell	629,95	527,14

Additional charge of 10% for CMHR foam in accordance with UK requirement.
Option to upholster with customer's own fabric available upon request. For further information please see our upholstery programme on page 464.



Harbour Dining Chair, Star base w/Swivel, Polished Aluminium / Dakar 0250, by Norm Architects
Androgynne Dining Table, Natural Oak / Kunis Breccia, by Danielle Siggerud

Harbour Dining Chair, Star Base, Swivel w/Return

BY NORM ARCHITECTS

Dining chair with upholstered or bare shell set on a polished aluminium or black powder coated aluminium star base with swivel with return.



PRODUCT OPTIONS

SHELL



WITHOUT UPHOLSTERY

WITH UPHOLSTERY

STAR BASE

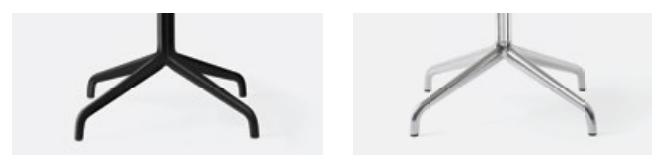

BLACK POWDER COATED ALUMINIUM

POLISHED ALUMINIUM

SPEC OPTIONS

Available in fabrics from our upholstery programme. Standard lead times apply. Custom upholstery available upon request. For further information please refer to MENU Upholstery Programme.



Harbour Dining Chair, Star Base, Swivel w/Return, Polished Aluminium / Dakar 0842, by Norm Architects
Snaregade Rectangular, Black steel / Charcoal Linoleum, by Norm Architects
Circular lamp, Black by Norm Architects

Harbour Dining Chair, Star Base, Swivel w/Return

BY NORM ARCHITECTS

TECHNICAL SPECIFICATIONS

PRODUCT TYPE
Dining chair

ENVIRONMENT
Indoor

DIMENSIONS

Star base
H: 81 cm / 31,9"
SH: 45 cm / 17,7"
AH: 67,5 cm / 26,6"
D: 59 cm / 23,2"
W: 59 cm / 23,2"

PRODUCTION PROCESS

The shell is made using injection moulded polypropylene with fibreglass. The star base is die-cast aluminium and the column is made of extruded aluminium.

COLOUR

Base
Black (RAL 9005)
Polished aluminium

Shell without upholstery

Burned red (RAL 8015)
Olive (RAL 7002)
Khaki (RAL 1011)
White (RAL 9016)
Light grey (RAL 9002)
Black (RAL 9011)

Shell with upholstery

Dependent upon selected upholstery.

GLOSS

Gloss 10-20

MATERIALS

Shell
85% polypropylene, 15% fibreglass

Upholstered shell foam
CAL117 50 kg / 50N and 40 kg / 60N

Star base
Cast, extruded aluminium.

WEIGHT
13 kg / 28,7 lb

TEST
EN1022:2005, L2
EN16139:2013, L2

CERTIFICATIONS
N / A

PACKAGING TYPE
Brown box

PACKAGING MEASUREMENTS (H x W x D)
86 cm x 62 cm x 65 cm / 34" x 24,4" x 25,6"



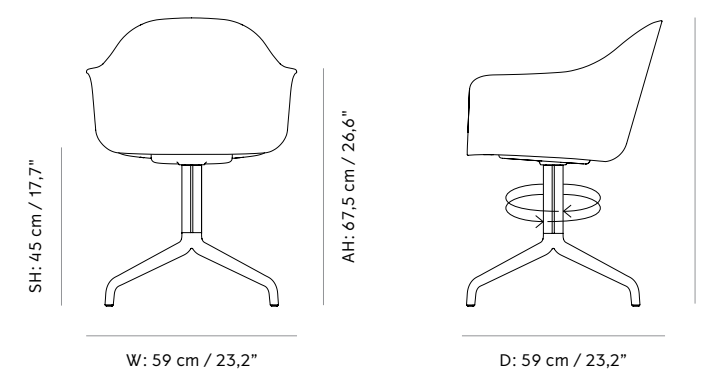





MATERIALS & MAINTENANCE
Please see page 486 for materials and care and maintenance instructions.



Harbour Dining Chair, Star Base, Swivel w/Return

BY NORM ARCHITECTS

RECOMMENDED COMBINATIONS — PRICES IN EUR *Selected combinations 6–8 weeks delivery time.*

SKU	VARIANT	INCL. VAT	EXCL. VAT
Shell with upholstery — Star base with return — Black aluminium			
9381939	 HARBOUR DINING CHAIR, STAR BASE, SWIVEL W/RETURN, BLACK ALUMINIUM / COLLINE 568	1.129,95	945,54
9381969	 HARBOUR DINING CHAIR, STAR BASE, SWIVEL W/RETURN, BLACK ALUMINIUM / HALLINGDAL 65 -0270	1.129,95	945,54
9381539	 HARBOUR DINING CHAIR, STAR BASE, SWIVEL W/RETURN, BLACK ALUMINIUM / DAKAR 0842	1.349,95	1.129,64
9381139	 HARBOUR DINING CHAIR, STAR BASE, SWIVEL W/RETURN, BLACK ALUMINIUM / NUANCE 40782	1.579,95	1.322,10
Shell with upholstery — Star base with return — Polished aluminium			
9382979	 HARBOUR DINING CHAIR, STAR BASE, SWIVEL W/RETURN, POLISHED ALUMINIUM / COLLINE 568	1.129,95	945,54
9382969	 HARBOUR DINING CHAIR, STAR BASE, SWIVEL W/RETURN, POLISHED ALUMINIUM / HALLINGDAL 65-0270	1.129,95	945,54
9382539	 HARBOUR DINING CHAIR, STAR BASE, SWIVEL W/RETURN, POLISHED ALUMINIUM / DAKAR 0842	1.349,95	1.129,64
9382139	 HARBOUR DINING CHAIR, STAR BASE, SWIVEL W/RETURN, POLISHED ALUMINIUM / NUANCE 40782	1.579,95	1.322,10
400274	 HARBOUR DINING CHAIR, STAR BASE, SWIVEL W/RETURN, POLISHED ALUMINIUM /SCHWARTZWALD 002	1.795,00	1.502,06

Additional charge of 10% for CMHR foam in accordance with UK requirement.
Option to upholster with customer's own fabric available upon request. For further information please see our upholstery programme on page 464.

Harbour Dining Chair, Star Base, Swivel w/Return

BY NORM ARCHITECTS

SPEC OPTIONS — PRICES IN EUR *Selected combinations 6–8 weeks delivery time.*

SKU	VARIANT	INCL. VAT	EXCL. VAT
Textile — Shell with upholstery — Star base with return — Black aluminium / Polished aluminium			
9381001	PRICE CATEGORY 1 Maple, Kvadrat / Remix 2, Kvadrat / City Velvet, JAB / Hot Madison Reloaded, JAB / Gaja C2C, Gabriel / Champion, Kvadrat	899,95	753,08
9381002	PRICE CATEGORY 2 Hallingdal 65, Kvadrat / Savanna, Kvadrat / Colline, Kvadrat / Canvas, Kvadrat / Ritz, Nevotex / Fiord, Kvadrat / Steelcut 2, Kvadrat / Steelcut Trio 3, Kvadrat / Moss, Kvadrat / Clay, Kvadrat / Divina Melange, Kvadrat	1.129,95	945,54
9381003	PRICE CATEGORY 3 Vintage, Astrid / Safire, Kvadrat / Satoriale Collection: Grisaille, Dedar / Ponpon, Dedar	1.399,95	1.171,48
9381008	PRICE CATEGORY 4 (NEW) Satoriale Collection: Doppiopanama, Dedar / Deco, Dedar Texturologie Collection: Lupo, Dedar / Atlas, Dedar	1.489,95	1.246,79
Leather — Shell with upholstery — Star base with return — Black aluminium / Polished aluminium			
9381004	PRICE CATEGORY 1 Ultra, Sørensen Leather / Dakar, Nevotex	1.349,95	1.129,64
9381005	PRICE CATEGORY 2 Dunes, Sørensen Leather / Shade, Sørensen Leather / Nuance, Sørensen Leather / Instill, Kvadrat	1.579,95	1.322,10
9381006	PRICE CATEGORY 3 Royal Nubuck, Sørensen Leather	1.939,95	1.623,35
9381007	PRICE CATEGORY 4 Elegance, Sørensen Leather	2.699,95	2.259,32
Shell without upholstery — Star base with return — Black aluminium / Polished aluminium			
9380000	Any star base with return / any shell	669,95	560,61

Additional charge of 10% for CMHR foam in accordance with UK requirement.
Option to upholster with customer's own fabric available upon request. For further information please see our upholstery programme on page 464.

Harbour Dining Chair, Star Base, w/Casters

BY NORM ARCHITECTS

Dining chair with upholstered or bare shell set on a polished aluminium or black powder coated aluminium star base with casters.



PRODUCT OPTIONS

SHELL

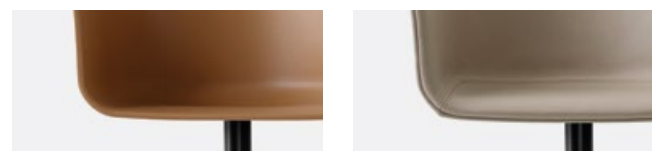

WITHOUT UPHOLSTERY

WITH UPHOLSTERY

STAR BASE WITH CASTERS

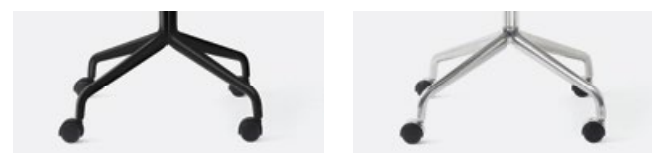

BLACK POWDER COATED ALUMINIUM

POLISHED ALUMINIUM

SPEC OPTIONS

Available in fabrics from our upholstery programme. Standard lead times apply. Custom upholstery available upon request. For further information please refer to MENU Upholstery Programme.

Harbour Chair, Star Base, Polished Aluminium / Hallingdal 65-0270 by Norm Architects

Harbour Dining Chair, Star Base, w/Casters

BY NORM ARCHITECTS

TECHNICAL SPECIFICATIONS

PRODUCT TYPE

Dining chair

ENVIRONMENT

Indoor

DIMENSIONS

Star base w. Casters

H: 82 cm / 32,3"
SH: 45 cm / 17,7"
AH: 67,5 cm / 26,6"
D: 58,5 cm / 23"
W: 58,5 cm / 23"

PRODUCTION PROCESS

The shell is made using injection moulded polypropylene with fibreglass. The star base is die-cast aluminium and the column is made of extruded aluminium.

COLOUR

Base

Black (RAL 9005)
Polished aluminium

Shell without upholstery

Burned red (RAL 8015)
Olive (RAL 7002)
Khaki (RAL 1011)
White (RAL 9016)
Light grey (RAL 9002)
Black (RAL 9011)

Shell with upholstery

Dependent upon selected upholstery.

GLOSS

Gloss 10-20

MATERIALS

Shell

85% polypropylene, 15% fibreglass

Upholstered shell foam

CAL117 50 kg / 50N and 40 kg / 60N

Star base

Cast, extruded aluminium.

Casters for powder coated base

PA6, PUR

Casters for polished aluminium base

Aluminium, PA6, PUR

WEIGHT

14 kg / 30,9 lb

TEST

N / A

CERTIFICATIONS

N / A

PACKAGING TYPE

Brown box

PACKAGING MEASUREMENTS (H x W x D)

86 cm x 62 cm x 65 cm / 34" x 24,4" x 25,6"

MATERIALS & MAINTENANCE



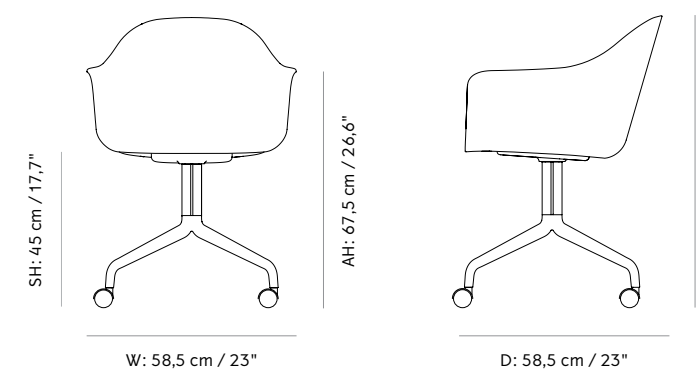





Please see page 486 for materials and care and maintenance instructions.



Harbour Dining Chair, Star Base, w/Casters

BY NORM ARCHITECTS

RECOMMENDED COMBINATIONS — PRICES IN EUR *Selected combinations 6–8 weeks delivery time.*

SKU	VARIANT	INCL. VAT	EXCL. VAT
Shell with upholstery — Star base with casters — Black aluminium			
9391939	 HARBOUR DINING CHAIR, STAR BASE W/CASTERS, BLACK ALUMINIUM / COLLINE 568	1.129,95	945,54
9391969	 HARBOUR DINING CHAIR, STAR BASE W/CASTERS, BLACK ALUMINIUM / HALLINGDAL 65 -0270	1.129,95	945,54
9391539	 HARBOUR DINING CHAIR, STAR BASE W/CASTERS, BLACK ALUMINIUM / DAKAR 0842	1.349,95	1.129,64
9391139	 HARBOUR DINING CHAIR, STAR BASE W/CASTERS, BLACK ALUMINIUM / NUANCE 40782	1.579,95	1.322,10
Shell with upholstery — Star base with casters — Polished aluminium			
9392939	 HARBOUR DINING CHAIR, STAR BASE W/CASTERS, POLISHED ALUMINIUM / COLLINE 568	1.129,95	945,54
9392969	 HARBOUR DINING CHAIR, STAR BASE W/CASTERS, POLISHED ALUMINIUM / HALLINGDAL 65-0270	1.129,95	945,54
9392539	 HARBOUR DINING CHAIR, STAR BASE W/CASTERS, POLISHED ALUMINIUM / DAKAR 0842	1.349,95	1.129,64
9392139	 HARBOUR DINING CHAIR, STAR BASE W/CASTERS, POLISHED ALUMINIUM / NUANCE 40782	1.579,95	1.322,10

Additional charge of 10% for CMHR foam in accordance with UK requirement.
Option to upholster with customer's own fabric available upon request. For further information please see our upholstery programme on page 464.

Harbour Dining Chair, Star Base, w/Casters

BY NORM ARCHITECTS

SPEC OPTIONS — PRICES IN EUR *Selected combinations 6–8 weeks delivery time.*

SKU	VARIANT	INCL. VAT	EXCL. VAT
Textile — Shell with upholstery — Star base with casters — Black aluminium / Polished aluminium			
9391001	PRICE CATEGORY 1 Maple, Kvadrat / Remix 2, Kvadrat / City Velvet, JAB / Hot Madison Reloaded, JAB / Gaja C2C, Gabriel / Champion, Kvadrat	899,95	753,08
9391002	PRICE CATEGORY 2 Hallingdal 65, Kvadrat / Savanna, Kvadrat / Colline, Kvadrat / Canvas, Kvadrat / Ritz, Nevotex / Fiord, Kvadrat / Steelcut 2, Kvadrat / Steelcut Trio 3, Kvadrat / Moss, Kvadrat / Clay, Kvadrat / Divina Melange, Kvadrat	1.129,95	945,54
9391003	PRICE CATEGORY 3 Vintage, Astrid / Safire, Kvadrat / Satoriale Collection: Grisaille, Dedar / Ponpon, Dedar	1.399,95	1.171,48
9391008	PRICE CATEGORY 4 (NEW) Satoriale Collection: Doppiopanama, Dedar / Deco, Dedar Texturologie Collection: Lupo, Dedar / Atlas, Dedar	1.489,95	1.246,79
Leather — Shell with upholstery — Star base with casters — Black aluminium / Polished aluminium			
9391004	PRICE CATEGORY 1 Ultra, Sørensen Leather / Dakar, Nevotex	1.349,95	1.129,64
9391005	PRICE CATEGORY 2 Dunes, Sørensen Leather / Shade, Sørensen Leather / Nuance, Sørensen Leather / Instill, Kvadrat	1.579,95	1.322,10
9391006	PRICE CATEGORY 3 Royal Nubuck, Sørensen Leather	1.939,95	1.623,35
9391007	PRICE CATEGORY 4 Elegance, Sørensen Leather	2.699,95	2.259,32
Shell without upholstery — Powder coated steel base — Black aluminium / Polished aluminium			
9391000	Any star base with casters / any shell	669,95	560,61

Additional charge of 10% for CMHR foam in accordance with UK requirement.
Option to upholster with customer's own fabric available upon request. For further information please see our upholstery programme on page 464.

Harbour Side Dining Chair, Star Base w/Swivel

BY NORM ARCHITECTS

Dining chair with upholstered or bare shell set on a polished aluminium or black powder coated aluminium star base with swivel.



PRODUCT OPTIONS

SHELL

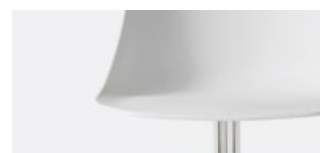

WITHOUT UPHOLSTERY



WITH UPHOLSTERY

STAR BASE



BLACK POWDER COATED ALUMINIUM



POLISHED ALUMINIUM

SPEC OPTIONS

Available in fabrics from our upholstery programme. Standard lead times apply. Custom upholstery available upon request. For further information please refer to MENU Upholstery Programme.

Harbour Side Dining Chair, Star Base w/Swivel, Black Aluminium / Khaki, by Norm Architects

Harbour Side Dining Chair, Star Base w/Swivel

BY NORM ARCHITECTS

TECHNICAL SPECIFICATIONS

PRODUCT TYPE

Dining chair

ENVIRONMENT

Indoor

DIMENSIONS

Star Base

H: 81 cm / 31,5"

SH: 45 cm / 17,7"

D: 59 cm / 23,2"

W: 59 cm / 23,2"

PRODUCTION PROCESS

The shell is made using injection moulded polypropylene with fibreglass. The star base is die-cast aluminium and the column is made of extruded aluminium.

COLOUR

Base

Black (RAL 9005)

Polished aluminium

Shell without upholstery

Burned red (RAL 8015)

Olive (RAL 7002)

Khaki (RAL 1011)

White (RAL 9016)

Light grey (RAL 9002)

Black (RAL 9011)

Shell with upholstery

Dependent upon selected upholstery.

GLOSS

Gloss 10-20

MATERIALS

Shell

85% polypropylene, 15% fibreglass

Upholstered shell foam

CAL117 50 kg / 50N and 40 kg / 60N

Base

Cast, extruded aluminium.

WEIGHT

13 kg / 28,7 lb

TEST

EN 1022:2005, L2

EN 1639:2013, L2

CERTIFICATIONS

N / A

PACKAGING TYPE

Brown box

PACKAGING MEASUREMENTS (H x W x D)

86 cm x 65 cm x 65 cm / 34" x 25,6" x 25,6"

MATERIALS & MAINTENANCE



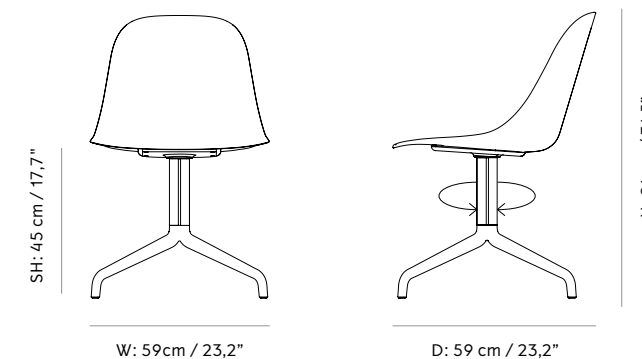

Please see page 486 for materials and care and maintenance instructions.



Harbour Side Dining Chair, Star Base w/Swivel

BY NORM ARCHITECTS









QUICK SHIP OPTIONS — PRICES IN EUR *Selected combinations up to 4 weeks delivery time.*

SKU	VARIANT	INCL. VAT	EXCL. VAT
Shell without upholstery — Star base — Black aluminium			
9265349	 HARBOUR SIDE DINING CHAIR, STAR BASE W/ SWIVEL, BLACK ALUMINIUM / BURNED RED	529,95	443,46
9265429	 HARBOUR SIDE DINING CHAIR, STAR BASE W/ SWIVEL, BLACK ALUMINIUM / OLIVE	529,95	443,46
9265849	 HARBOUR SIDE DINING CHAIR, STAR BASE W/ SWIVEL, BLACK ALUMINIUM / KHAKI	529,95	443,46
9265539	 HARBOUR SIDE DINING CHAIR, STAR BASE W/ SWIVEL, BLACK ALUMINIUM / BLACK	529,95	443,46
Shell without upholstery — Star base — Polished aluminium			
9260639	 HARBOUR SIDE DINING CHAIR, STAR BASE W/ SWIVEL, POLISHED ALUMINIUM / WHITE	529,95	443,46

Harbour Side Dining Chair, Star Base w/Swivel

BY NORM ARCHITECTS

RECOMMENDED COMBINATIONS — PRICES IN EUR *Selected combinations 6–8 weeks delivery time.*

SKU	VARIANT	INCL. VAT	EXCL. VAT
Shell with upholstery — Star base — Black aluminium			
9265939	 HARBOUR SIDE DINING CHAIR, STAR BASE W/ SWIVEL, BLACK ALUMINIUM / COLLINE 568	879,95	736,34
9265969	 HARBOUR SIDE DINING CHAIR, STAR BASE W/ SWIVEL, BLACK ALUMINIUM / HALLINGDAL 65, 0270	879,95	736,34
9265559	 HARBOUR SIDE DINING CHAIR, STAR BASE W/ SWIVEL, BLACK ALUMINIUM / DAKAR 0842	1.049,95	878,60
9265159	 HARBOUR SIDE DINING CHAIR, STAR BASE W/ SWIVEL, BLACK ALUMINIUM / NUANCE 40782	1.229,95	1.029,22
Shell with upholstery — Star base — Polished aluminium			
9260939	 HARBOUR SIDE DINING CHAIR, STAR BASE W/ SWIVEL, ALUMINIUM / COLLINE 568	879,95	736,34
9260969	 HARBOUR SIDE DINING CHAIR, STAR BASE W/ SWIVEL, POLISHED ALUMINIUM / HALLINGDAL 65, 0270	879,95	736,34
9260559	 HARBOUR SIDE DINING CHAIR, STAR BASE W/ SWIVEL, POLISHED ALUMINIUM / DAKAR 0842	1.049,95	878,60
9260159	 HARBOUR SIDE DINING CHAIR, STAR BASE W/ SWIVEL, POLISHED ALUMINIUM / NUANCE 40782	1.229,95	1.029,22

Additional charge of 10% for CMHR foam in accordance with UK requirement.
Option to upholster with customer's own fabric available upon request. For further information please see our upholstery programme on page 464.

Harbour Side Dining Chair, Star Base w/Swivel

BY NORM ARCHITECTS

SPEC OPTIONS — PRICES IN EUR *Selected combinations 6–8 weeks delivery time.*

SKU	VARIANT	INCL. VAT	EXCL. VAT
Textile — Shell with upholstery — Star base — Black aluminium / Polished aluminium			
9396001	PRICE CATEGORY 1 Maple, Kvadrat / Remix 2, Kvadrat / City Velvet, JAB / Hot Madison Reloaded, JAB / Gaja C2C, Gabriel / Champion, Kvadrat	699,95	585,72
9396002	PRICE CATEGORY 2 Hallingdal 65, Kvadrat / Savanna, Kvadrat / Colline, Kvadrat / Canvas, Kvadrat / Ritz, Nevotex / Fiord, Kvadrat / Steelcut 2, Kvadrat / Steelcut Trio 3, Kvadrat / Moss, Kvadrat / Clay, Kvadrat / Divina Melange, Kvadrat	879,95	736,34
9396003	PRICE CATEGORY 3 Vintage, Astrid / Safire, Kvadrat / Satoriale Collection: Grisaille, Dedar / Ponpon, Dedar	1.089,95	912,07
9396008	PRICE CATEGORY 4 (NEW) Satoriale Collection: Doppioanama, Dedar / Deco, Dedar Texturologie Collection: Lupo, Dedar / Atlas, Dedar	1.159,95	970,65
Leather — Shell with upholstery — Star base — Black aluminium / Polished aluminium			
9396004	PRICE CATEGORY 1 Ultra, Sørensen Leather / Dakar, Nevotex	1.049,95	878,60
9396005	PRICE CATEGORY 2 Dunes, Sørensen Leather / Shade, Sørensen Leather / Nuance, Sørensen Leather / Instill, Kvadrat	1.229,95	1.029,22
9396006	PRICE CATEGORY 3 Royal Nubuck, Sørensen Leather	1.509,95	1.263,53
9396007	PRICE CATEGORY 4 Elegance, Sørensen Leather	2.099,95	1.757,24
Shell without upholstery — Star base — Black aluminium / Polished aluminium			
9396939	Any star base with swivel / any shell	529,95	443,46

Additional charge of 10% for CMHR foam in accordance with UK requirement.
Option to upholster with customer's own fabric available upon request. For further information please see our upholstery programme on page 464.

Harbour Side Dining Chair, Star Base w/Swivel, Polished aluminium / Dakar 0250, by Norm Architects
Snaregade Rectangular, Black Steel / Charcoal Linoleum, by Norm Architects
Peek Table Lamp, Black, by Jonas Wagell



Harbour Side Dining Chair, Star Base, Swivel w/Return

BY NORM ARCHITECTS

Dining chair with upholstered or bare shell set on a polished aluminium or black powder coated aluminium star base with swivel with return.



PRODUCT OPTIONS

SHELL

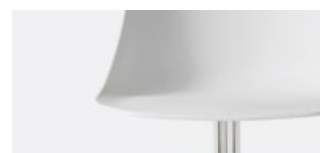

WITHOUT UPHOLSTERY



WITH UPHOLSTERY

STAR BASE



BLACK POWDER COATED ALUMINIUM



POLISHED ALUMINIUM

SPEC OPTIONS

Available in fabrics from our upholstery programme. Standard lead times apply. Custom upholstery available upon request. For further information please refer to MENU Upholstery Programme.

Harbour Chair, Star Base, Polished Aluminium / Hallingdal 65-0270 by Norm Architects

Harbour Side Dining Chair, Star Base, Swivel w/Return

BY NORM ARCHITECTS

TECHNICAL SPECIFICATIONS

PRODUCT TYPE
Dining chair

ENVIRONMENT
Indoor

DIMENSIONS

Star base
H: 81 cm / 31,5"
SH: 45 cm / 17,7"
D: 59 cm / 23,2"
W: 59 cm / 23,2"

PRODUCTION PROCESS

The shell is made using injection moulded polypropylene with fibreglass. The star base is die-cast aluminium and the column is made of extruded aluminium.

COLOUR

Base
Black (RAL 9005)
Polished aluminium

Shell without Upholstery

Burned red (RAL 8015)
Olive (RAL 7002)
Khaki (RAL 1011)
White (RAL 9016)
Light grey (RAL 9002)
Black (RAL 9011)

Shell with upholstery

Dependent upon selected upholstery.

GLOSS

Gloss 10-20

MATERIALS

Shell
85% polypropylene, 15% fibreglass

Upholstered shell foam
CAL117 50 kg / 50N and 40 kg / 60N

Base
Cast, extruded aluminium.

WEIGHT
13 kg / 28,7 lb

TEST
EN 1022:2005, L2
EN 1639:2013, L2

CERTIFICATIONS
N / A

PACKAGING TYPE
Brown box

PACKAGING MEASUREMENTS (H x W x D)
86 cm x 65 cm x 65 cm / 34" x 25,6" x 25,6"

MATERIALS & MAINTENANCE
Please see page 486 for materials and care and maintenance instructions.

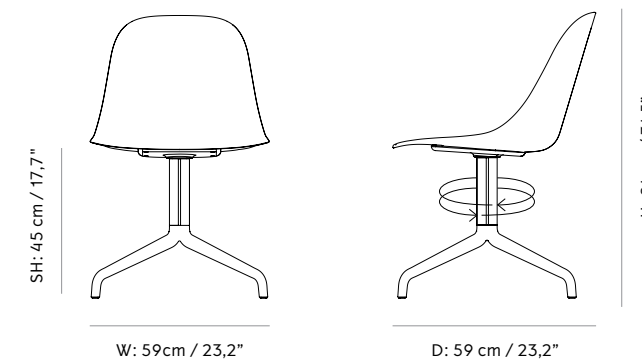

Harbour Side Dining Chair, Star Base, Swivel w/Return

BY NORM ARCHITECTS

Harbour Side Dining Chair, Dakar 0311 & Dakar 0250, by Norm Architects

SPEC OPTIONS — PRICES IN EUR *Selected combinations 6–8 weeks delivery time.*

SKU	VARIANT	INCL. VAT	EXCL. VAT
Textile — Shell with upholstery — Star base w/Return — Black aluminium / Polished aluminium			
9397001	PRICE CATEGORY 1 Maple, Kvadrat / Remix 2, Kvadrat / City Velvet, JAB / Hot Madison Reloaded, JAB / Gaja C2C, Gabriel / Champion, Kvadrat	749,95	627,56
9397002	PRICE CATEGORY 2 Hallingdal 65, Kvadrat / Savanna, Kvadrat / Colline, Kvadrat / Canvas, Kvadrat / Ritz, Nevotex / Fiord, Kvadrat / Steelcut 2, Kvadrat / Steelcut Trio 3, Kvadrat / Moss, Kvadrat / Clay, Kvadrat / Divina Melange, Kvadrat	939,95	786,55
9397003	PRICE CATEGORY 3 Vintage, Astrid / Safire, Kvadrat / Satoriale Collection: Grisaille, Dedar / Ponpon, Dedar	1.169,95	979,01
9397008	PRICE CATEGORY 4 (NEW) Satoriale Collection: Doppioanama, Dedar / Deco, Dedar Texturologie Collection: Lupo, Dedar / Atlas, Dedar	1.239,95	1.037,59
Leather — Shell with upholstery — Star base w/Return — Black aluminium / Polished aluminium			
9397004	PRICE CATEGORY 1 Ultra, Sørensen Leather / Dakar, Nevotex	1.129,95	945,54
9397005	PRICE CATEGORY 2 Dunes, Sørensen Leather / Shade, Sørensen Leather / Nuance, Sørensen Leather / Instill, Kvadrat	1.319,95	1.104,53
9397006	PRICE CATEGORY 3 Royal Nubuck, Sørensen Leather	1.619,95	1.355,57
9397007	PRICE CATEGORY 4 Elegance, Sørensen Leather	2.249,95	1.882,76
Shell without upholstery — Star base w/Return — Black aluminium / Polished aluminium			
9397939	Any star base with swivel with return / any shell	569,95	476,93

Additional charge of 10% for CMHR foam in accordance with UK requirement.
Option to upholster with customer's own fabric available upon request. For further information please see our upholstery programme on page 464.



Harbour Side Dining Chair, Star Base, w/Casters

BY NORM ARCHITECTS

Dining chair with upholstered or bare shell set on a polished aluminium or black powder coated aluminium star base with casters.



PRODUCT OPTIONS

SHELL



WITHOUT UPHOLSTERY



WITH UPHOLSTERY

STAR BASE WITH CASTERS



BLACK POWDER COATED ALUMINIUM



POLISHED ALUMINIUM

SPEC OPTIONS

Available in fabrics from our upholstery programme. Standard lead times apply. Custom upholstery available upon request. For further information please refer to MENU Upholstery Programme.

Harbour Chair, Star Base, Polished Aluminium / Hallingdal 65-0270 by Norm Architects

Harbour Side Dining Chair, Star Base, w/Casters

BY NORM ARCHITECTS

TECHNICAL SPECIFICATIONS

PRODUCT TYPE
Dining chair

ENVIRONMENT
Indoor

DIMENSIONS

Star Base w. Casters
H: 81 cm / 31,5"
SH: 45 cm / 17,7"
D: 59 cm / 23,2"
W: 59 cm / 23,2"

PRODUCTION PROCESS

The shell is made using injection moulded polypropylene with fibreglass. The star base is die-cast aluminium and the column is made of extruded aluminium.

COLOUR

Base
Black (RAL 9005)
Polished aluminium

Shell without upholstery

Burned red (RAL 8015)
Olive (RAL 7002)
Khaki (RAL 1011)
White (RAL 9016)
Light grey (RAL 9002)
Black (RAL 9011)

Shell with upholstery

Dependent upon selected upholstery.

GLOSS

Gloss 10-20

MATERIALS

Shell
85% polypropylene, 15% fibreglass

Upholstered shell foam
CAL117 50 kg / 50N and 40 kg / 60N

Base
Cast, extruded aluminium.

Casters for powder coated base
PA6, PUR

Casters for polished aluminium base
Aluminium, PA6, PUR

WEIGHT
14 kg / 30,9 lb

TEST
N / A

CERTIFICATIONS
N / A

PACKAGING TYPE
Brown box

PACKAGING MEASUREMENTS (H x W x D)
86 cm x 65 cm x 65 cm / 34" x 25,6" x 25,6"

MATERIALS & MAINTENANCE
Please see page 486 for materials and care and maintenance instructions.

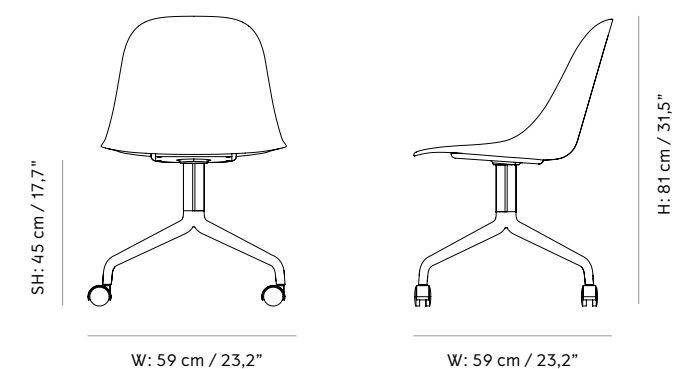

Harbour Side Dining Chair, Star Base, w/Casters

BY NORM ARCHITECTS

SPEC OPTIONS — PRICES IN EUR *Available in any textile or leather from our Upholstery Program with standard lead time.*

SKU	VARIANT	INCL. VAT	EXCL. VAT
Textile — Shell with upholstery — Star base w/Casters — Black aluminium / Polished aluminium			
9398001	PRICE CATEGORY 1 Maple, Kvadrat / Remix 2, Kvadrat / City Velvet, JAB / Hot Madison Reloaded, JAB / Gaja C2C, Gabriel / Champion, Kvadrat	749,95	627,56
9398002	PRICE CATEGORY 2 Hallingdal 65, Kvadrat / Savanna, Kvadrat / Colline, Kvadrat / Canvas, Kvadrat / Ritz, Nevotex / Fiord, Kvadrat / Steelcut 2, Kvadrat / Steelcut Trio 3, Kvadrat / Moss, Kvadrat / Clay, Kvadrat / Divina Melange, Kvadrat	939,95	786,55
9398003	PRICE CATEGORY 3 Vintage, Astrid / Safire, Kvadrat / Satoriale Collection: Grisaille, Dedar / Ponpon, Dedar	1.169,95	979,01
9398008	PRICE CATEGORY 4 (NEW) Satoriale Collection: Doppioanama, Dedar / Deco, Dedar Texturologie Collection: Lupo, Dedar / Atlas, Dedar	1.239,95	1.037,59
Leather — Shell with upholstery — Star base w/Casters — Black aluminium / Polished aluminium			
9398004	PRICE CATEGORY 1 Ultra, Sørensen Leather / Dakar, Nevotex	1.129,95	945,54
9398005	PRICE CATEGORY 2 Dunes, Sørensen Leather / Shade, Sørensen Leather / Nuance, Sørensen Leather / Instill, Kvadrat	1.319,95	1.104,53
9398006	PRICE CATEGORY 3 Royal Nubuck, Sørensen Leather	1.619,95	1.355,57
9398007	PRICE CATEGORY 4 Elegance, Sørensen Leather	2.249,95	1.882,76
Shell without upholstery — Star base w/Casters — Black aluminium / Polished aluminium			
9398939	Any star base with casters / any shell	569,95	476,93

Additional charge of 10% for CMHR foam in accordance with UK requirement.
Option to upholster with customer's own fabric available upon request. For further information please see our upholstery programme on page 464.



Harbour Side Dining Chair, Star Base w/Casters, Polished Aluminium / Colline 568, by Norm Architects
Snaregade Dining Table, Rectangular, Black Steel / Charcoal Linoleum, by Norm Architects
Stackable Glass, by Norm Architects
TR Bulb Suspension Frame, Brushed Brass / Matte Opal, by Tim Rundle
Bottle Carafe, 1 L, Clear Glass / Brass, by Norm Architects

Harbour Counter/Bar Chair

BY NORM ARCHITECTS

Counter or bar chair with upholstered or bare shell set on a powder coated steel base with crossbar foot support.



PRODUCT OPTIONS

SHELL

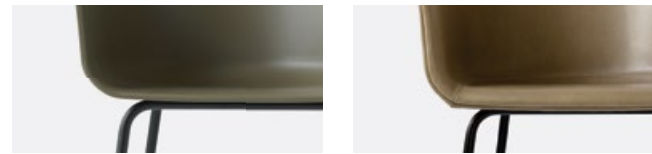

WITHOUT UPHOLSTERY

WITH UPHOLSTERY

POWDER COATED STEEL BASE

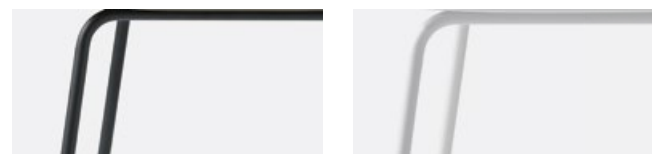

BLACK STEEL

LIGHT GREY STEEL

SPEC OPTIONS

Available in fabrics from our upholstery programme. Standard lead times apply. Custom upholstery available upon request. For further information please refer to MENU Upholstery Programme.

Harbour Counter/Bar Chair

BY NORM ARCHITECTS

TECHNICAL SPECIFICATIONS

PRODUCT TYPE

Counter and bar chair

ENVIRONMENT

Indoor

DIMENSIONS

Counter

H: 102 cm / 40"
SH: 63 cm / 24,8"
AH: 88,5 cm / 35"
D: 58,5 cm / 23"
W: 59 cm / 23,2"

Bar

H: 112 cm / 44"
SH: 73 cm / 28,7"
AH: 98,5 / 38,8"
D: 58,5 cm / 23"
W: 59 cm / 23,2"

PRODUCTION PROCESS

The shell is made from injection-moulded polypropylene with fibreglass. Steel bases are made of bent powder coated steel tubes with a MIG-welded footing.

COLOUR

Base

Black (RAL 9005)
Light grey (RAL 9002)

Shell without upholstery

Burned red (RAL 8015)
Olive (RAL 7002)
Khaki (RAL 1011)
White (RAL 9016)
Light grey (RAL 9002)
Black (RAL 9011)

Shell with upholstery

Dependent upon selected upholstery.

GLOSS

Gloss 10-20

MATERIALS

Shell

85% polypropylene, 15% fibreglass

Upholstered shell foam

CAL117 50 kg / 50N and 40 kg / 60N

Base

Powder coated steel

WEIGHT

Counter: 14 kg / 30,9 lb
Bar: 14 kg / 30,9 lb

TEST

EN1022:2005, L2
EN16139:2013, L2

CERTIFICATIONS

N / A

PACKAGING TYPE

Brown box

PACKAGING MEASUREMENTS (H x W x D)

Counter

114 cm x 65 cm x 62 cm / 44,9" x 25,6" x 24,4"

Bar

114 cm x 65 cm x 62 cm / 44,9" x 25,6" x 24,4"

MATERIALS & MAINTENANCE

Please see page 486 for materials and care and maintenance instructions.

HARBOUR COUNTER CHAIR

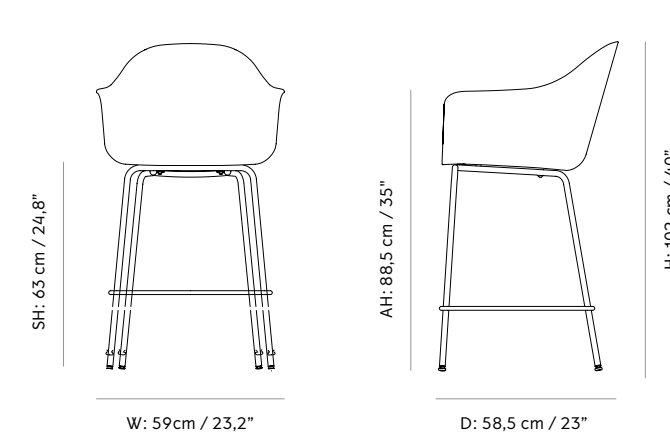



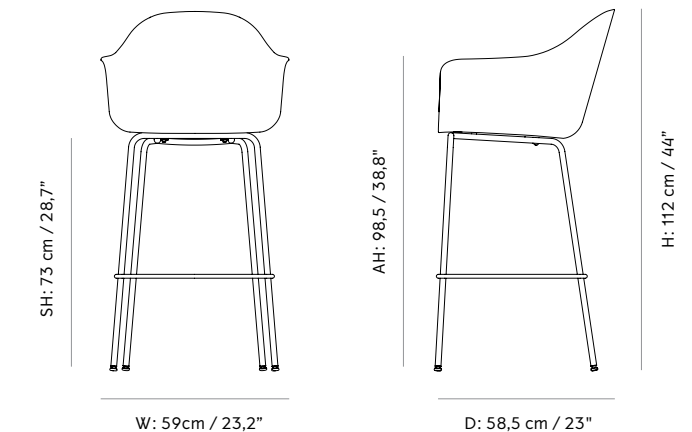



HARBOUR BAR CHAIR



Harbour Counter Chair

BY NORM ARCHITECTS

QUICK SHIP OPTIONS — PRICES IN EUR *Selected combinations up to 4 weeks delivery time.*











SKU	VARIANT	INCL. VAT	EXCL. VAT
Shell without upholstery — Powder coated steel base — Black steel			
9365349	 HARBOUR COUNTER CHAIR, BLACK STEEL / BURNED RED	349,95	292,84
9365429	 HARBOUR COUNTER CHAIR, BLACK STEEL / OLIVE	349,95	292,84
9365849	 HARBOUR SIDE CHAIR, BLACK STEEL / KHAKI	349,95	292,84
9342639	 HARBOUR COUNTER CHAIR, BLACK STEEL / WHITE	349,95	292,84
9365539	 HARBOUR COUNTER CHAIR, BLACK STEEL / BLACK	349,95	292,84
Shell without upholstery — Powder coated steel base — Light grey steel			
9361639	 HARBOUR COUNTER CHAIR, LIGHT GREY STEEL / WHITE	349,95	292,84
9361640	 HARBOUR COUNTER CHAIR, LIGHT GREY STEEL / LIGHT GREY	349,95	292,84

Additional charge of 10% for CMHR foam in accordance with UK requirement.
Option to upholster with customer's own fabric available upon request. For further information please see our upholstery programme on page 464.

Harbour Counter Chair

BY NORM ARCHITECTS

RECOMMENDED COMBINATIONS — PRICES IN EUR *Selected combinations 6–8 weeks delivery time.*

SKU	VARIANT	INCL. VAT	EXCL. VAT
Shell with upholstery — Powder coated steel base — Black steel			
9343008	 HARBOUR COUNTER CHAIR, BLACK STEEL / REMIX 2, 233	699,95	585,72
9343009	 HARBOUR COUNTER CHAIR, BLACK STEEL / CITY VELVET CA7832/060	699,95	585,72
9365159	 HARBOUR COUNTER CHAIR, BLACK STEEL / HOT MADISON CHI 249/988	699,95	585,72
9365469	 HARBOUR COUNTER CHAIR, BLACK STEEL / CITY VELVET CA7832/031	699,95	585,72
9365989	 HARBOUR COUNTER CHAIR, BLACK STEEL / CITY VELVET CA7832/078	699,95	585,72
9365939	 HARBOUR COUNTER CHAIR, BLACK STEEL / COLLINE 568	879,95	736,34
9365139	 HARBOUR COUNTER CHAIR, BLACK STEEL / HALLINGDAL 65, 130	879,95	736,34
9343010	 HARBOUR COUNTER CHAIR, BLACK STEEL / DAKAR 0842	1.049,95	878,60
9365979	 HARBOUR COUNTER CHAIR, BLACK STEEL / DAKAR 0250	1.049,95	878,60
9365169	 HARBOUR COUNTER CHAIR, BLACK STEEL / DAKAR 0311	1.049,95	878,60

Additional charge of 10% for CMHR foam in accordance with UK requirement.
Option to upholster with customer's own fabric available upon request. For further information please see our upholstery programme on page 464.

Harbour Counter Chair

BY NORM ARCHITECTS

SPEC OPTIONS — PRICES IN EUR *Selected combinations 6–8 weeks delivery time.*

SKU	VARIANT	INCL. VAT	EXCL. VAT
Textile — Shell with upholstery — Powder coated steel base — Black steel / Light grey steel			
9343001	PRICE CATEGORY 1 Maple, Kvadrat / Remix 2, Kvadrat / City Velvet, JAB / Hot Madison Reloaded, JAB / Gaja C2C, Gabriel / Champion, Kvadrat	699,95	585,72
9343002	PRICE CATEGORY 2 Hallingdal 65, Kvadrat / Savanna, Kvadrat / Colline, Kvadrat / Canvas, Kvadrat / Ritz, Nevotex / Fiord, Kvadrat / Steelcut 2, Kvadrat / Steelcut Trio 3, Kvadrat / Moss, Kvadrat / Clay, Kvadrat / Divina Melange, Kvadrat	879,95	736,34
9343003	PRICE CATEGORY 3 Vintage, Astrid / Safire, Kvadrat / Satoriale Collection: Grisaille, Dedar / Ponpon, Dedar	1.089,95	912,07
9343018	PRICE CATEGORY 4 (NEW) Satoriale Collection: Doppiopanama, Dedar / Deco, Dedar Texturologie Collection: Lupo, Dedar / Atlas, Dedar	1.159,95	970,65
Leather — Shell with upholstery — Powder coated steel base — Black steel / Light grey steel			
9343004	PRICE CATEGORY 1 Ultra, Sørensen Leather / Dakar, Nevotex	1.049,95	878,60
9343005	PRICE CATEGORY 2 Dunes, Sørensen Leather / Shade, Sørensen Leather / Nuance, Sørensen Leather / Instill, Kvadrat	1.229,95	1.029,22
9343006	PRICE CATEGORY 3 Royal Nubuck, Sørensen Leather	1.509,95	1.263,53
9343007	PRICE CATEGORY 4 Elegance, Sørensen Leather	2.099,95	1.757,24
Shell without upholstery — Powder coated steel base — Black steel / Light grey steel			
9343100	Any counter base / any shell	349,95	292,84

Additional charge of 10% for CMHR foam in accordance with UK requirement.
Option to upholster with customer's own fabric available upon request. For further information please see our upholstery programme on page 464.









Column Table Lamp, by Norm Architects
Stackable Glass, by Norm Architects
Harbour Counter Chair, Black Steel / LC1, Col. 1 Bianco, by Norm Architects
Harbour Column Counter Table, Ø80, Black Steel / Estremoz Marble, by Norm Architects

Harbour Bar Chair

BY NORM ARCHITECTS











QUICK SHIP OPTIONS — PRICES IN EUR *Selected combinations up to 4 weeks delivery time.*

SKU	VARIANT	INCL. VAT	EXCL. VAT
Shell without upholstery — Powder coated steel base — Black steel			
9345349	 HARBOUR BAR CHAIR, BLACK STEEL / BURNED RED	349,95	292,84
9345429	 HARBOUR BAR CHAIR, BLACK STEEL / OLIVE	349,95	292,84
9345849	 HARBOUR BAR CHAIR, BLACK STEEL / KHAKE	349,95	292,84
9344639	 HARBOUR BAR CHAIR, BLACK STEEL / WHITE	349,95	292,84
9345539	 HARBOUR BAR CHAIR, BLACK STEEL / BLACK	349,95	292,84
Shell without upholstery — Powder coated steel base — Light grey steel			
9341639	 HARBOUR BAR CHAIR, LIGHT GREY STEEL / WHITE	349,95	292,84
9341139	 HARBOUR BAR CHAIR, LIGHT GREY STEEL / LIGHT GREY	349,95	292,84

Harbour Bar Chair

BY NORM ARCHITECTS

RECOMMENDED COMBINATIONS — PRICES IN EUR *Selected combinations 6–8 weeks delivery time.*

SKU	VARIANT	INCL. VAT	EXCL. VAT
Shell with upholstery — Powder coated steel base — Black steel			
9345049	 HARBOUR BAR CHAIR, BLACK STEEL / REMIX 2, 233	699,95	585,72
9345989	 HARBOUR BAR CHAIR, BLACK STEEL / CITY VELVET CA 7832/078	699,95	585,72
9345469	 HARBOUR BAR CHAIR, BLACK STEEL / CITY VELVET CA 7832/031	699,95	585,72
9345819	 HARBOUR BAR CHAIR, BLACK STEEL / CITY VELVET CA 7832/060	699,95	585,72
9345159	 HARBOUR BAR CHAIR, BLACK STEEL / HOT MADISON CHI 249/988	699,95	585,72
9345139	 HARBOUR BAR CHAIR, BLACK STEEL / HALLINGDAL 65, 130	879,95	736,34
9345939	 HARBOUR BAR CHAIR, BLACK STEEL / COLLINE 568	879,95	736,34
9345010	 HARBOUR BAR CHAIR, BLACK STEEL / DAKAR 0842	1.049,95	878,60
9345979	 HARBOUR BAR CHAIR, BLACK STEEL / DAKAR 0250	1.049,95	878,60
9345169	 HARBOUR BAR CHAIR, BLACK STEEL / DAKAR 0311	1.049,95	878,60

Additional charge of 10% for CMHR foam in accordance with UK requirement.
Option to upholster with customer's own fabric available upon request. For further information please see our upholstery programme on page 464.

Harbour Bar Chair

BY NORM ARCHITECTS

SPEC OPTIONS — PRICES IN EUR *Selected combinations 6–8 weeks delivery time.*

SKU	VARIANT	INCL. VAT	EXCL. VAT
Textile — Shell with upholstery — Powder coated steel base — Black steel / Light grey steel			
9345001	PRICE CATEGORY 1 Maple, Kvadrat / Remix 2, Kvadrat / City Velvet, JAB / Hot Madison Reloaded, JAB / Gaja C2C, Gabriel / Champion, Kvadrat	699,95	585,72
9345002	PRICE CATEGORY 2 Hallingdal 65, Kvadrat / Savanna, Kvadrat / Colline, Kvadrat / Canvas, Kvadrat / Ritz, Nevotex / Fiord, Kvadrat / Steelcut 2, Kvadrat / Steelcut Trio 3, Kvadrat / Moss, Kvadrat / Clay, Kvadrat / Divina Melange, Kvadrat	879,95	736,34
9345003	PRICE CATEGORY 3 Vintage, Astrid / Safire, Kvadrat / Satoriale Collection: Grisaille, Dedar / Ponpon, Dedar	1.089,95	912,07
9345018	PRICE CATEGORY 4 (NEW) Satoriale Collection: Doppiopanama, Dedar / Deco, Dedar Texturologie Collection: Lupo, Dedar / Atlas, Dedar	1.159,95	970,65
Leather — Shell with upholstery — Powder coated steel base — Black steel / Light grey steel			
9345004	PRICE CATEGORY 1 Ultra, Sørensen Leather / Dakar, Nevotex	1.049,95	878,60
9345005	PRICE CATEGORY 2 Dunes, Sørensen Leather / Shade, Sørensen Leather / Nuance, Sørensen Leather / Instill, Kvadrat	1.229,95	1.029,22
9345006	PRICE CATEGORY 3 Royal Nubuck, Sørensen Leather	1.509,95	1.263,53
9345007	PRICE CATEGORY 4 Elegance, Sørensen Leather	2.099,95	1.757,24
Shell without upholstery — Powder coated steel base — Black steel / Light grey steel			
9345100	Any bar base / any shell	349,95	292,84

Additional charge of 10% for CMHR foam in accordance with UK requirement.
Option to upholster with customer's own fabric available upon request. For further information please see our upholstery programme on page 464.



Harbour Counter Chair, Black Steel / LC1, Col. 1 Bianco,
by Norm Architects
Snaregade Counter Table, Black Steel / Charcoal Linoleum,
by Norm Architects

Harbour Side Counter/Bar Chair

BY NORM ARCHITECTS

Counter or bar chair with upholstered or bare shell set on a powder coated steel base with crossbar foot support.



PRODUCT OPTIONS

SHELL



WITHOUT UPHOLSTERY



WITH UPHOLSTERY

POWDER COATED STEEL BASE



BLACK STEEL



LIGHT GREY STEEL

SPEC OPTIONS

Available in fabrics from our upholstery programme. Standard lead times apply. Custom upholstery available upon request. For further information please refer to MENU Upholstery Programme.

Harbour Side Counter/Bar Chair

BY NORM ARCHITECTS

TECHNICAL SPECIFICATIONS

PRODUCT TYPE
Counter and bar chair

ENVIRONMENT
Indoor

DIMENSIONS

Counter
H: 102 cm / 40"
SH: 63 cm / 24,8"
D: 58,5 cm / 23"
W: 52,5 cm / 20,5"

Bar
H: 112 cm / 44"
SH: 73 cm / 28,7"
D: 58,5 cm / 23"
W: 52 cm / 20,5"

PRODUCTION PROCESS

The shell is made from injection-moulded polypropylene with fibreglass. Steel bases are made of bent powder coated steel tubes with a MIG-welded footring.

COLOUR

Base
Black (RAL 9005)
Light grey (RAL 9002)

Shell without upholstery

Burned red (RAL 8015)
Olive (RAL 7002)
Khaki (RAL 1011)
White (RAL 9016)
Light grey (RAL 9002)
Black (RAL 9011)

Shell with upholstery

Dependent upon selected upholstery.

GLOSS

Gloss 10-20

MATERIALS

Shell
85% polypropylene, 15% fibreglass

Upholstered shell foam
CAL117 50 kg / 50N and 40 kg / 60N

Base
Powder coated steel

WEIGHT

Counter: 14 kg / 30,9 lb
Bar: 14 kg / 30,9 lb

TEST

EN1022:2005, L2
EN16139:2013, L2

CERTIFICATIONS

N / A

PACKAGING TYPE

Brown box

PACKAGING MEASUREMENTS (H x W x D)

Counter

114 cm x 65 cm x 62 cm / 44,9" x 25,6" x 24,4"

Bar

114 cm x 65 cm x 62 cm / 44,9" x 25,6" x 24,4"

MATERIALS & MAINTENANCE

Please see page 486 for materials and care and maintenance instructions.

HARBOUR COUNTER SIDE CHAIR

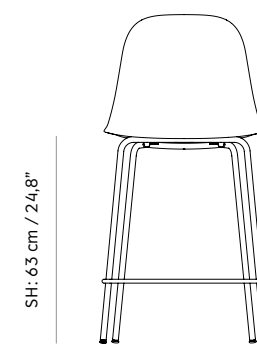

SH: 63 cm / 24,8"

W: 52 cm / 20,5"

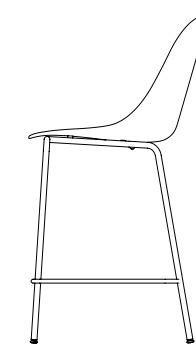

H: 102 cm / 40"

D: 58,5 cm / 23"

HARBOUR BAR SIDE CHAIR

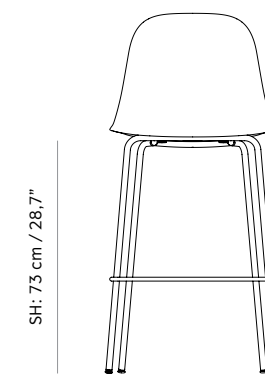

SH: 73 cm / 28,7"

W: 52 cm / 20,5"

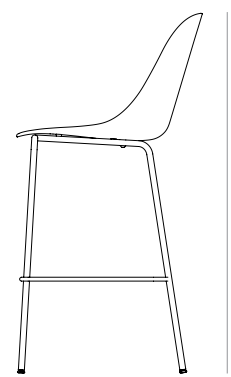







H: 112 cm / 44"

D: 58,5 cm / 23"

Harbour Side Counter Chair

BY NORM ARCHITECTS











QUICK SHIP OPTIONS — PRICES IN EUR *Selected combinations up to 4 weeks delivery time.*

SKU	VARIANT	INCL. VAT	EXCL. VAT
Shell without upholstery — Powder coated steel base — Black steel			
9295349	 HARBOUR SIDE COUNTER CHAIR, BLACK STEEL / BURNED RED	319,95	267,73
9295429	 HARBOUR SIDE COUNTER CHAIR, BLACK STEEL / OLIVE	319,95	267,73
9295849	 HARBOUR SIDE COUNTER CHAIR, BLACK STEEL / KHAKI	319,95	267,73
9295539	 HARBOUR SIDE COUNTER CHAIR, BLACK STEEL / BLACK	319,95	267,73
Shell without upholstery — Powder coated steel base — Light grey steel			
9291639	 HARBOUR SIDE COUNTER CHAIR, LIGHT GREY STEEL / WHITE	319,95	267,73
9291139	 HARBOUR SIDE COUNTER CHAIR, LIGHT GREY STEEL / LIGHT GREY	319,95	267,73

Harbour Side Counter Chair

BY NORM ARCHITECTS

RECOMMENDED COMBINATIONS — PRICES IN EUR *Selected combinations 6–8 weeks delivery time.*

SKU	VARIANT	INCL. VAT	EXCL. VAT
Shell with upholstery — Powder coated steel base — Black steel			
9295049	 HARBOUR SIDE COUNTER CHAIR, BLACK STEEL / REMIX 2, 233	599,95	502,04
9295159	 HARBOUR SIDE COUNTER CHAIR, BLACK STEEL / HOT MADISON CHI 249/988	599,95	502,04
9295469	 HARBOUR SIDE COUNTER CHAIR, BLACK STEEL / CITY VELVET CA7832/031	599,95	502,04
9365819	 HARBOUR SIDE COUNTER CHAIR, BLACK STEEL / CITY VELVET CA7832/060	599,95	502,04
9295819	 HARBOUR SIDE COUNTER CHAIR, BLACK STEEL / CITY VELVET CA7832/078	599,95	502,04
9295139	 HARBOUR SIDE COUNTER CHAIR, BLACK STEEL / HALLINGDAL 65, 130	749,95	627,56
9295939	 HARBOUR SIDE COUNTER CHAIR, BLACK STEEL / COLLINE 568	749,95	627,56
9295169	 HARBOUR SIDE COUNTER CHAIR, BLACK STEEL / DAKAR 0311	899,95	753,08
9295559	 HARBOUR SIDE COUNTER CHAIR, BLACK STEEL / DAKAR 0842	899,95	753,08
9295979	 HARBOUR SIDE COUNTER CHAIR, BLACK STEEL / DAKAR 0250	899,95	753,08

Additional charge of 10% for CMHR foam in accordance with UK requirement.
Option to upholster with customer's own fabric available upon request. For further information please see our upholstery programme on page 464.

Harbour Side Counter Chair

BY NORM ARCHITECTS

SPEC OPTIONS — PRICES IN EUR *Selected combinations 6–8 weeks delivery time.*

SKU	VARIANT	INCL. VAT	EXCL. VAT
Textile — Shell with upholstery — Powder coated steel base — Black steel / Light grey steel			
9290001	PRICE CATEGORY 1 Maple, Kvadrat / Remix 2, Kvadrat / City Velvet, JAB / Hot Madison Reloaded, JAB / Gaja C2C, Gabriel / Champion, Kvadrat	599,95	502,04
9290002	PRICE CATEGORY 2 Hallingdal 65, Kvadrat / Savanna, Kvadrat / Colline, Kvadrat / Canvas, Kvadrat / Ritz, Nevotex / Fiord, Kvadrat / Steelcut 2, Kvadrat / Steelcut Trio 3, Kvadrat / Moss, Kvadrat / Clay, Kvadrat / Divina Melange, Kvadrat	749,95	627,56
9290003	PRICE CATEGORY 3 Vintage, Astrid / Safire, Kvadrat / Satoriale Collection: Grisaille, Dedar / Ponpon, Dedar	929,95	778,18
9290008	PRICE CATEGORY 4 (NEW) Satoriale Collection: Doppiopanama, Dedar / Deco, Dedar Texturologie Collection: Lupo, Dedar / Atlas, Dedar	989,95	828,39
Leather — Shell with upholstery — Powder coated steel base — Black steel / Light grey steel			
9290004	PRICE CATEGORY 1 Ultra, Sørensen Leather / Dakar, Nevotex	899,95	753,08
9290005	PRICE CATEGORY 2 Dunes, Sørensen Leather / Shade, Sørensen Leather / Nuance, Sørensen Leather / Instill, Kvadrat	1.049,95	878,60
9290006	PRICE CATEGORY 3 Royal Nubuck, Sørensen Leather	1.289,95	1.079,43
9290007	PRICE CATEGORY 4 Elegance, Sørensen Leather	1.799,95	1.506,20
Shell without upholstery — Powder coated steel base — Black steel / Light grey steel			
9290100	Any base / any shell	319,95	267,73

Additional charge of 10% for CMHR foam in accordance with UK requirement.
Option to upholster with customer's own fabric available upon request. For further information please see our upholstery programme on page 464.









Harbour Column Bar Table, Black Steel / Black Painted Oak, by Norm Architects
Harbour Side Bar Chair, Black Steel / Burned Red, by Norm Architects
Troll Vase, Amber, by Anderssen & Voll

Harbour Side Bar Chair

BY NORM ARCHITECTS











QUICK SHIP OPTIONS — PRICES IN EUR *Selected combinations up to 4 weeks delivery time.*

SKU	VARIANT	INCL. VAT	EXCL. VAT
Shell without upholstery — Powder coated steel base — Black steel			
9285349	 HARBOUR SIDE BAR CHAIR, BLACK STEEL / BURNED RED	319,95	267,73
9285429	 HARBOUR SIDE BAR CHAIR, BLACK STEEL / OLIVE	319,95	267,73
9285849	 HARBOUR SIDE BAR CHAIR, BLACK STEEL / KHAKI	319,95	267,73
9285539	 HARBOUR SIDE BAR, BLACK STEEL / BLACK	319,95	267,73
Shell without upholstery — Powder coated steel base — Light grey steel			
9281639	 HARBOUR SIDE BAR CHAIR, LIGHT GREY STEEL / WHITE	319,95	267,73
9281139	 HARBOUR SIDE BAR CHAIR, LIGHT GREY STEEL / LIGHT GREY	319,95	267,73

Harbour Side Bar Chair

BY NORM ARCHITECTS

RECOMMENDED COMBINATIONS — PRICES IN EUR *Selected combinations 6–8 weeks delivery time.*

SKU	VARIANT	INCL. VAT	EXCL. VAT
Shell without upholstery — Powder coated steel base — Black steel			
9285049	 HARBOUR SIDE BAR CHAIR, BLACK STEEL / REMIX 2, 233	599,95	502,04
9285159	 HARBOUR SIDE BAR CHAIR, BLACK STEEL / HOT MADISON CHI 249/988	599,95	502,04
9285469	 HARBOUR SIDE BAR CHAIR, BLACK STEEL / CITY VELVET CA7832/031	599,95	502,04
9285819	 HARBOUR SIDE BAR CHAIR, BLACK STEEL / CITY VELVET CA7832/060	599,95	502,04
9285989	 HARBOUR SIDE BAR CHAIR, BLACK STEEL / CITY VELVET CA7832/078	599,95	502,04
9285139	 HARBOUR SIDE BAR CHAIR, BLACK STEEL / HALLINGDAL 65, 130	749,95	627,56
9285939	 HARBOUR SIDE BAR CHAIR, BLACK STEEL BASE / COLLINE 568	749,95	627,56
9285169	 HARBOUR SIDE BAR CHAIR, BLACK STEEL / DAKAR 0311	899,95	753,08
9285559	 HARBOUR SIDE BAR CHAIR, BLACK STEEL / DAKAR 0842	899,95	753,08
9285979	 HARBOUR SIDE BAR CHAIR, BLACK STEEL / DAKAR 0250	899,95	753,08

Additional charge of 10% for CMHR foam in accordance with UK requirement.
Option to upholster with customer's own fabric available upon request. For further information please see our upholstery programme on page 464.

Harbour Side Bar Chair

BY NORM ARCHITECTS

SPEC OPTIONS — PRICES IN EUR *Selected combinations 6–8 weeks delivery time.*

SKU	VARIANT	INCL. VAT	EXCL. VAT
Textile — Shell with upholstery — Powder coated steel base — Black steel / Light grey steel			
9280001	PRICE CATEGORY 1 Maple, Kvadrat / Remix 2, Kvadrat / City Velvet, JAB / Hot Madison Reloaded, JAB / Gaja C2C, Gabriel / Champion, Kvadrat	599,95	502,04
9280002	PRICE CATEGORY 2 Hallingdal 65, Kvadrat / Savanna, Kvadrat / Colline, Kvadrat / Canvas, Kvadrat / Ritz, Nevotex / Fiord, Kvadrat / Steelcut 2, Kvadrat / Steelcut Trio 3, Kvadrat / Moss, Kvadrat / Clay, Kvadrat / Divina Melange, Kvadrat	749,95	627,56
9280003	PRICE CATEGORY 3 Vintage, Astrid / Safire, Kvadrat / Satoriale Collection: Grisaille, Dedar / Ponpon, Dedar	929,95	778,18
9280008	PRICE CATEGORY 4 (NEW) Satoriale Collection: Doppiopanama, Dedar / Deco, Dedar Texturologie Collection: Lupo, Dedar / Atlas, Dedar	989,95	828,39
Leather — Shell with upholstery — Powder coated steel base — Black Steel / Light grey steel			
9280004	PRICE CATEGORY 1 Ultra, Sørensen Leather / Dakar, Nevotex	899,95	753,08
9280005	PRICE CATEGORY 2 Dunes, Sørensen Leather / Shade, Sørensen Leather / Nuance, Sørensen Leather / Instill, Kvadrat	1.049,95	878,60
9280006	PRICE CATEGORY 3 Royal Nubuck, Sørensen Leather	1.289,95	1.079,43
9280007	PRICE CATEGORY 4 Elegance, Sørensen Leather	1.799,95	1.506,20
Shell without upholstery — Powder coated steel base — Black steel / Light grey steel			
9280100	Any base / any shell	319,95	267,73

Additional charge of 10% for CMHR foam in accordance with UK requirement.
Option to upholster with customer's own fabric available upon request. For further information please see our upholstery programme on page 464.

Harbour Side Bar Chair, Black Steel / Burned Red, by Norm Architects
Harbour Column Bar Table, Black Steel / Black Painted Oak, by Norm Architects
Plinth Tall, Grey Kendzo Marble, by Norm Architects
Troll Vase, Amber, by Anderssen & Voll
Bank Pendant, Black / Smoke, by Norm Architects



Harbour Lounge Chair

BY NORM ARCHITECTS

Solid wood base chair in natural, dark stained or black oak or walnut with visible joinery. Upholstered moulded foam shell, angled backrest and curved armrests. Corresponding upholstered cushion.



PRODUCT OPTIONS

SOLID OAK BASE



NATURAL OAK

DARK STAINED OAK

BLACK OAK

WALNUT BASE

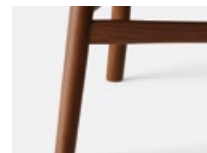

WALNUT

SPEC OPTIONS

Available in fabrics from our upholstery programme. Standard lead times apply. Custom upholstery available upon request. For further information please refer to MENU Upholstery Programme.

Harbour Lounge Chair, Natural Oak/Savanna 222 / Nuance Light Grey, by Norm Architects
Zet Storing System, 2x4, Black Steel / Black Painted Oak Veneer, by Kaschkasch
Gravel Rug, Ivory, by Nina Bruun

Harbour Lounge Chair

BY NORM ARCHITECTS

TECHNICAL SPECIFICATIONS

PRODUCT TYPE
Lounge chair

ENVIRONMENT
Indoor

DIMENSIONS

H: 80 cm / 31,5"
SH: 43 cm / 19,9"
W: 76 cm / 30"
D: 70 cm / 27,5"
AH: 61 cm / 24"

PRODUCTION PROCESS

Shell and seat cushion are shaped from moulded foam. The inner construction is made of steel and the wood base is made of CNC-cut solid wood.

COLOUR

Shell
Dependent upon selected upholstery.

Base
Natural oak
Dark stained oak
Black oak
Walnut

GLOSS
N / A

MATERIALS

Shell / Cushion
Moulded HR foam index 97

Wood Base
Natural oak with matte lacquer, dark stained oak with mat lacquer, black painted oak or walnut with matte lacquer

WEIGHT
17 kg / 37,5 lb

TEST
N / A

CERTIFICATIONS
N / A

PACKAGING TYPE
Brown box

PACKAGING MEASUREMENTS (H x W x D)
82 cm x 73 cm x 85 cm / 32,3" x 28,7" x 33,5"

MATERIALS & MAINTENANCE
Please see page 486 for materials and care and maintenance instructions.

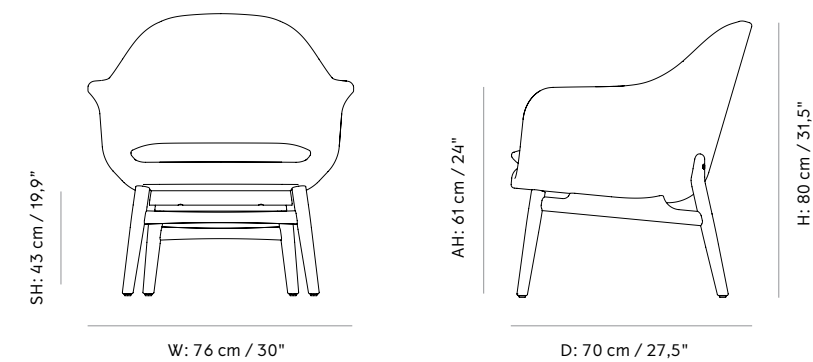

Harbour Lounge Chair

BY NORM ARCHITECTS

RECOMMENDED COMBINATIONS — PRICES IN EUR *Selected combinations 6–8 weeks delivery time.*

SKU	VARIANT	INCL. VAT	EXCL. VAT
Upholstered shell — Textile — Upholstered cushion — Leather — Wood base — Natural oak / Dark stained oak / Black oak / Walnut			
9255569	 HARBOUR LOUNGE CHAIR, BLACK OAK / SHELL: SAVANNA 152 / CUSHION: SHADE 20296	2.379,95	1.991,54
9255179	 HARBOUR LOUNGE CHAIR, DARK STAINED OAK / SHELL: SAVANNA 262 / CUSHION: NUANCE 40783	2.379,95	1.991,54
9255159	 HARBOUR LOUNGE CHAIR, NATURAL OAK / SHELL: SAVANNA 222 / CUSHION: NUANCE 40782	2.379,95	1.991,54
9255549	 HARBOUR LOUNGE CHAIR, WALNUT / SHELL: SAVANNA 672 / CUSHION: SHADE 20296	2.499,95	2.091,96

Additional charge of 10% for CMHR foam in accordance with UK requirement.
Option to upholster with customer's own fabric available upon request. For further information please see our upholstery programme on page 464.

Harbour Lounge Chair

BY NORM ARCHITECTS

SPEC OPTIONS — PRICES IN EUR *Selected combinations 6–8 weeks delivery time.*

SKU	VARIANT	INCL. VAT	EXCL. VAT
Textile — Upholstered shell and cushion — Wood base — Walnut			
9255201	PRICE CATEGORY 1 Maple, Kvadrat / Remix 2, Kvadrat / City Velvet, JAB / Hot Madison Reloaded, JAB / Gaja C2C, Gabriel / Champion, Kvadrat	1.999,95	1.673,56
9255202	PRICE CATEGORY 2 Hallingdal 65, Kvadrat / Savanna, Kvadrat / Colline, Kvadrat / Canvas, Kvadrat / Ritz, Nevotex / Fiord, Kvadrat / Steelcut 2, Kvadrat / Steelcut Trio 3, Kvadrat / Moss, Kvadrat / Clay, Kvadrat / Divina Melange, Kvadrat	2.499,95	2.091,96
9255203	PRICE CATEGORY 3 Vintage, Astrid / Safire, Kvadrat / Satoriale Collection: Grisaille, Dedar / Ponpon, Dedar	3.099,95	2.594,04
9255208	PRICE CATEGORY 4 (NEW) Satoriale Collection: Doppiopanama, Dedar / Deco, Dedar Texturologie Collection: Lupo, Dedar / Atlas, Dedar	3.299,95	2.761,40
Leather — Upholstered shell and cushion — Wood base — Walnut			
9255204	PRICE CATEGORY 1 Ultra, Sørensen Leather / Dakar, Nevotex	2.999,95	2.510,36
9255205	PRICE CATEGORY 2 Dunes, Sørensen Leather / Shade, Sørensen Leather / Nuance, Sørensen Leather / Instill, Kvadrat	3.499,95	2.928,76
9255206	PRICE CATEGORY 3 Royal Nubuck, Sørensen Leather	3.999,95	3.347,16
9255207	PRICE CATEGORY 4 Elegance, Sørensen Leather	4.199,95	3.514,52

Additional charge of 10% for CMHR foam in accordance with UK requirement.
Option to upholster with customer's own fabric available upon request. For further information please see our upholstery programme on page 464.

Harbour Lounge Chair

BY NORM ARCHITECTS

SPEC OPTIONS — PRICES IN EUR *Selected combinations 6–8 weeks delivery time.*

SKU	VARIANT	INCL. VAT	EXCL. VAT
Textile — Upholstered shell and cushion — Solid oak base — Natural oak / Dark stained oak / Black oak			
9255101	PRICE CATEGORY 1 Maple, Kvadrat / Remix 2, Kvadrat / City Velvet, JAB / Hot Madison Reloaded, JAB / Gaja C2C, Gabriel / Champion, Kvadrat	1.899,95	1.589,88
9255102	PRICE CATEGORY 2 Hallingdal 65, Kvadrat / Savanna, Kvadrat / Colline, Kvadrat / Canvas, Kvadrat / Ritz, Nevotex / Fiord, Kvadrat / Steelcut 2, Kvadrat / Steelcut Trio 3, Kvadrat / Moss, Kvadrat / Clay, Kvadrat / Divina Melange, Kvadrat	2.379,95	1.991,54
9255103	PRICE CATEGORY 3 Vintage, Astrid / Safire, Kvadrat / Satoriale Collection: Grisaille, Dedar / Ponpon, Dedar	2.949,95	2.468,52
9255108	PRICE CATEGORY 4 (NEW) Satoriale Collection: Doppioanama, Dedar / Deco, Dedar Texturologie Collection: Lupo, Dedar / Atlas, Dedar	3.139,95	2.627,51
Leather — Upholstered shell and cushion — Solid oak base — Natural oak / Dark stained oak / Black oak			
9255104	PRICE CATEGORY 1 Ultra, Sørensen Leather / Dakar, Nevotex	2.849,95	2.384,84
9255105	PRICE CATEGORY 2 Dunes, Sørensen Leather / Shade, Sørensen Leather / Nuance, Sørensen Leather / Instill, Kvadrat	3.329,95	2.786,50
9255106	PRICE CATEGORY 3 Royal Nubuck, Sørensen Leather	3.799,95	3.179,80
9255107	PRICE CATEGORY 4 Elegance, Sørensen Leather	3.989,95	3.338,79

Additional charge of 10% for CMHR foam in accordance with UK requirement.
Option to upholster with customer's own fabric available upon request. For further information please see our upholstery programme on page 464.

Harbour Lounge Chair, Natural Oak / Savanna 222 / Nuance Leather Light Grey,
by Norm Architects
Harbour Lounge Chair, Black Oak / Savanna 152 / Shade 20296,
by Norm Architects
Gravel Rug, Ivory, by Nina Bruun



Harbour Column Lounge Table, Star Base

BY NORM ARCHITECTS

Star-shaped, black powder coated aluminium and steel base with round kunis breccia, estremoze marble, black painted oak or linoleum tabletop.

PRODUCT OPTIONS

TABLETOP



BLACK PAINTED OAK



CHARCOAL LINOLEUM



ESTREMOZ MARBLE



KUNIS BRECCIA STONE

BASE



BLACK POWDER COATED ALUMINIUM & STEEL

Harbour Column Lounge Table, Ø80, Black Aluminium & Steel / Kunis Breccia, by Norm Architects
Harbour Lounge Chair, Black Oak / Savanna 152 / Shade 20296, by Norm Architects



Harbour Column Lounge Table, Star Base

BY NORM ARCHITECTS

TECHNICAL SPECIFICATIONS

PRODUCT TYPE
Lounge table

ENVIRONMENT
Indoor

DIMENSIONS
H: 50 cm / 19,7"
Ø: 80 cm / 31,5"

PRODUCTION PROCESS
Star base is made of die-cast aluminium and column is made of extruded aluminium. The top plate for mounting the tabletop to the base, is made from flame cut steel. The tabletops are CNC milled. The tabletop in kunis breccia and estremoze is treated with a sealer.

COLOUR

Base
Black (RAL 9005)

Tabletop
Black (RAL 9005)
Charcoal (RAL 7012)
Off white (Estremoze marble)
Sand (Kunis breccia)

GLOSS
Gloss 10-20

MATERIALS

Base
Cast, extruded aluminium, steel.

Tabletop
Kunis breccia stone, estremoze marble, MDF and forbo linoleum or MDF and painted oak veneer.

WEIGHT

Star Base
3,5 kg / 7,7 lb

Column
1,1 kg / 2,4 lb

Topplate
6,4 kg / 14,1 lb

Tabletop oak or linoleum
9 kg / 19,8 lb

Tabletop marble or stone
52,8 kg / 116,4 lb

TEST
EN 15372:2016, L2

CERTIFICATIONS
TSCA title VI compliant

PACKAGING TYPE
Brown box

PACKAGING MEASUREMENTS (H x W x D)

Star Base
22 cm x 51 cm x 51 cm / 8,7" x 20,1" x 20,1"

Column (H x Ø)
30 cm x 7 cm / 11,8" x 2,8"

Topplate
6 cm x 48 cm x 48 cm / 2,4" x 18,9" x 18,9"

Tabletop oak or linoleum
6 cm x 85 cm x 85 cm / 2,4" x 33,5" x 33,5"

Tabletop marble or stone
90 cm x 90 cm x 10 cm / 35,4" x 35,4" x 4"

MATERIALS & MAINTENANCE
Please see page 486 for materials and care and maintenance instructions.

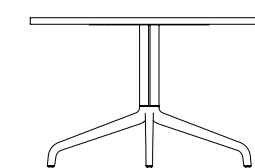
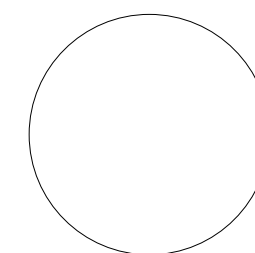

Ø: 80 cm / 31,5"

H: 50 cm / 19,7"



Harbour Column Lounge Table

BY NORM ARCHITECTS

STOCK OPTIONS — PRICES IN EUR *Selected combinations up to 2 weeks delivery time.*

SKU	VARIANT	INCL. VAT	EXCL. VAT
Harbour Column Lounge Table — Star base — Ø80			
9303539	 HARBOUR COLUMN LOUNGE TABLE, Ø80, BLACK ALUMINIUM & STEEL / BLACK OAK (NEW)	699,95	585,72
9303659	 HARBOUR COLUMN LOUNGE TABLE, Ø80, BLACK ALUMINIUM & STEEL / ESTREMOZ MARBLE (NEW)	999,95	836,76

SPEC OPTIONS — PRICES IN EUR *Selected combinations 6–8 weeks delivery time.*

SKU	VARIANT	INC. VAT	EX. VAT
Harbour Column Lounge Table — Star base — Ø80			
9303149	 HARBOUR COLUMN LOUNGE TABLE, Ø80, BLACK ALUMINIUM & STEEL / CHARCOAL LINOLEUM (NEW)	699,95	585,72
9303139	 HARBOUR COLUMN LOUNGE TABLE, Ø80, BLACK ALUMINIUM & STEEL / KUNIS BRECCIA STONE (NEW)	1.139,95	953,91

Knitting Chair, Dark Stained Oak / Dakar 0311, by Ib Kofod-Larsen
Harbour Column Lounge Table, Ø80, Black Aluminium & Steel / Kunis breccia, by Norm Architects



Harbour Column Dining Table

BY NORM ARCHITECTS

Black powder coated aluminium and steel base with round or rectangular tabletop in kunis breccia, estremoze marble, black painted oak or linoleum.



PRODUCT OPTIONS

TABLETOP

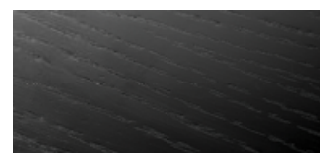

BLACK PAINTED OAK

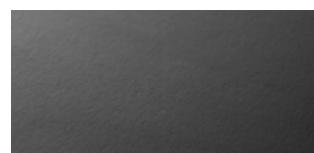

CHARCOAL LINOLEUM



ESTREMOZE MARBLE



KUNIS BRECCIA STONE

BASE

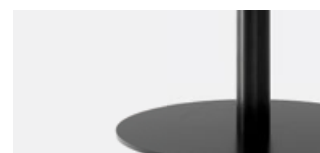

BLACK POWDER COATED ALUMINIUM & STEEL

Harbour Column Dining Table, Ø105, Black Steel / Estremoze Marble, by Norm Architects
Tearoom Club Chair, City Velvet CA7832/062, by Nick Ross



Harbour Column Dining Table

BY NORM ARCHITECTS

TECHNICAL SPECIFICATIONS

PRODUCT TYPE
Dining table

ENVIRONMENT
Indoor

DIMENSIONS

Ø60
H: 73 cm / 28,7"
Ø: 60 cm / 23,6"

Ø80
H: 73 cm / 28,7"
Ø: 80 cm / 31,5"

Ø105
H: 73 cm / 28,7"
W: 70 cm / 27,6"
D: 60 cm / 23,6"

70x60
H: 73 cm / 28,7"
W: 70 cm / 27,6"
D: 60 cm / 23,6"

PRODUCTION PROCESS

Both base and top plate for mounting the tabletop to the base are made from flame-cut steel. The column is made of extruded aluminium. Tabletops are CNC milled and kunis breccia and estremoze marble versions are treated with a sealer.

COLOUR

Base
Black (RAL 9005)

Tabletop
Black (RAL 9005)
Charcoal (RAL 7012)
Off white (Estremoze marble)
Sand (Kunis breccia)

GLOSS
Gloss 10-20

MATERIALS

Base
Cast, extruded aluminium, steel.

Tabletop
Kunis breccia stone, estremoze marble, MDF and forbo linoleum or MDF and painted oak veneer.

WEIGHT

Base
Ø50: 12,9 kg / 28,4 lb
Ø70: 25,3 kg / 55,8 lb

Column
2,4 kg / 5,3 lb

Topplate
6,4 kg / 14,1 lb

Tabletop oak or linoleum
Ø60: 8 kg / 17,6 lb
Ø80: 9 kg / 19,8 lb
70x60: 8,5 kg / 18,7 lb

Tabletop marble or stone
Ø60: 28 kg / 61,7 lb
Ø80: 52,8 kg / 116,4 lb
Ø105: 80 kg / 176,4 lb
70x60: 36 kg / 79,4 lb

TEST
EN 15372:2016, L2

CERTIFICATIONS
TSCA title VI compliant

PACKAGING TYPE
Brown box

PACKAGING MEASUREMENTS (H x W x D)

Base Ø50
6 cm x 58 cm x 58 cm / 2,4" x 22,8" x 22,8"

Base Ø70
6 cm x 80 cm x 80 cm / 2,4" x 31,5" x 31,5"

Column (H x Ø)
75 cm x 7 cm / 29,5" x 2,8"

Topplate
6 cm x 48 cm x 48 cm / 2,4" x 18,9" x 18,9"

Tabletop oak or linoleum Ø60
6 cm x 65 cm x 65 cm / 2,4" x 25,6" x 25,6"

Tabletop oak or linoleum Ø80
6 cm x 85 cm x 85 cm / 2,4" x 33,5" x 33,5"

Tabletop oak or linoleum 70x60
6 cm x 75 cm x 65 cm / 2,4" x 29,5" x 25,6"

Tabletop marble or stone Ø60
70 cm x 70 cm x 10 cm / 27,6" x 27,6" x 4"

Tabletop marble or stone Ø80
90 cm x 90 cm x 10 cm / 35,4" x 35,4" x 4"

Tabletop marble or stone Ø105
115 cm x 115 cm x 10 cm / 42,3" x 42,3" x 4"

Tabletop marble or stone 70x60
80 cm x 70 cm x 10 cm / 31,5" x 27,6" x 4"



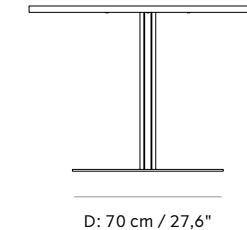
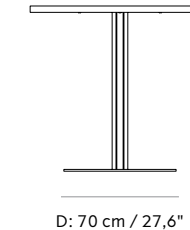
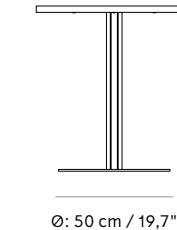
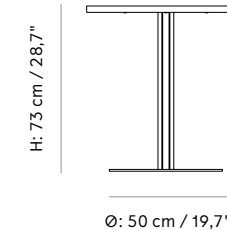
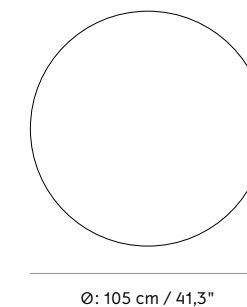
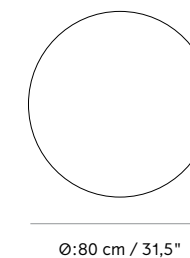
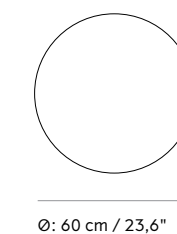
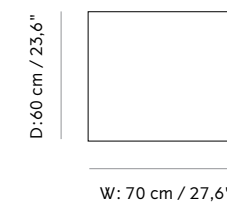



MATERIALS & MAINTENANCE
Please see page 486 for materials and care and maintenance instructions.



Harbour Column Dining Table

BY NORM ARCHITECTS







STOCK OPTIONS — PRICES IN EUR *Selected combinations up to 2 weeks delivery time.*

SKU	VARIANT	INCL. VAT	EXCL. VAT
Harbour Column Dining Table — Ø60			
9317539	 HARBOUR COLUMN DINING TABLE, Ø60, BLACK ALUMINIUM & STEEL / BLACK OAK	549,95	460,20
9317659	 HARBOUR COLUMN DINING TABLE, Ø60, BLACK ALUMINIUM & STEEL / ESTREMOZ MARBLE	849,95	711,24
Harbour Column Dining Table — Ø80			
9305539	 HARBOUR COLUMN DINING TABLE, Ø80, BLACK ALUMINIUM & STEEL / BLACK OAK	599,95	502,04
9305659	 HARBOUR COLUMN DINING TABLE, Ø80 CM, BLACK ALUMINIUM & STEEL / ESTREMOZ MARBLE	899,95	753,08
Harbour Column Dining Table — Ø105			
9316659	 HARBOUR COLUMN DINING TABLE, Ø105, BLACK ALUMINIUM & STEEL / ESTREMOZ MARBLE	1.399,95	1.171,48
Harbour Column Dining Table — 70x60			
9308539	 HARBOUR COLUMN DINING TABLE, 70X60, BLACK ALUMINIUM & STEEL / BLACK OAK	549,95	460,20
9308659	 HARBOUR COLUMN DINING TABLE, 70X60, BLACK ALUMINIUM & STEEL / ESTREMOZ MARBLE	849,95	711,24

Harbour Column Dining Table

BY NORM ARCHITECTS

SPEC OPTIONS — PRICES IN EUR *Selected combinations 6–8 weeks delivery time.*

SKU	VARIANT	INCL. VAT	EXCL. VAT
Harbour Column Dining Table — Ø60			
9317149	 HARBOUR COLUMN DINING TABLE, Ø60, BLACK ALUMINIUM & STEEL / CHARCOAL LINOLEUM	549,95	460,20
9317139	 HARBOUR COLUMN DINING TABLE, Ø60 CM, BLACK ALUMINIUM & STEEL / KUNIS BRECCIA STONE (NEW)	949,95	794,92
Harbour Column Dining Table — Ø80			
9305149	 HARBOUR COLUMN DINING TABLE, Ø80, BLACK ALUMINIUM & STEEL / CHARCOAL LINOLEUM	599,95	502,04
9305139	 HARBOUR COLUMN DINING TABLE, Ø80 CM, BLACK ALUMINIUM & STEEL / KUNIS BRECCIA STONE (NEW)	999,95	836,76
Harbour Column Dining Table — Ø105			
9316139	 HARBOUR COLUMN DINING TABLE, Ø105, BLACK ALUMINIUM & STEEL / KUNIS BRECCIA STONE (NEW)	1.499,95	1.255,16
Harbour Column Dining Table — 70x60			
9308149	 HARBOUR COLUMN DINING TABLE, 70X60, BLACK ALUMINIUM & STEEL / CHARCOAL LINOLEUM	549,95	460,20
9308139	 HARBOUR COLUMN DINING TABLE, 70X60, BLACK ALUMINIUM & STEEL / KUNIS BRECCIA STONE (NEW)	949,95	794,92

Harbour Column Dining Table, Star Base

BY NORM ARCHITECTS

Star-shaped, black powder coated aluminium and steel base with round or rectangular tabletop in kunis breccia, estremoza marble, black painted oak or linoleum.

PRODUCT OPTIONS

TABLETOP



BLACK PAINTED OAK

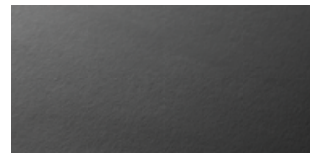

CHARCOAL LINOLEUM



ESTREMOZ MARBLE

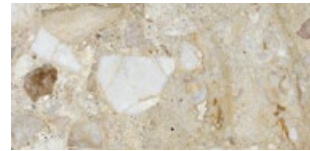

KUNIS BRECCIA STONE

BASE



BLACK POWDER COATED ALUMINIUM & STEEL

Harbour Column Dining Table Ø60, Star Base, Kunis Breccia Stone, by Norm Architects
 Harbour Column Bar Table, Star Base 70x60, Kunis Breccia Stone, by Norm Architects
 Harbour Column Lounge Table. Ø80, Star Base, Kunis Breccia Stone, by Norm Architects

Harbour Column Dining Table, Star Base

BY NORM ARCHITECTS

TECHNICAL SPECIFICATIONS

PRODUCT TYPE
Dining table

Off white (Estremoza marble)
Sand (Kunis breccia)

CERTIFICATIONS
TSCA title VI compliant

ENVIRONMENT
Indoor

GLOSS
Gloss 10-20

PACKAGING TYPE
Brown box

DIMENSIONS

Ø60
H: 73 cm / 28,7"
Ø: 60 cm / 23,6"

Ø80
H: 73 cm / 28,7"
Ø: 80 cm / 31,5"

Ø105
H: 73 cm / 28,7"
Ø: 105 cm / 41,3"

70x60
H: 73 cm / 28,7"
W: 70 cm / 27,6"
D: 60 cm / 23,6"

MATERIALS

Base
Cast, extruded aluminium, steel.

Tabletop
Kunis breccia stone, estremoza marble, MDF and forbo linoleum or MDF and painted oak veneer.

WEIGHT

Star Base
3,5 kg / 7,7 lb

Column
1,8 kg / 4 lb

Topplate
6,4 kg / 14,1 lb

Tabletop oak or linoleum
Ø60: 8 kg / 17,6 lb
Ø80: 9 kg / 19,8 lb
70x60: 8,5 kg / 18,7 lb

Tabletop marble or stone
Ø60: 28 kg / 61,7 lb
Ø80: 52,8 kg / 116,4 lb
Ø105: 80 kg / 176,4 lb
70x60: 36 kg / 79,4 lb

PRODUCTION PROCESS

Star base is made of die-cast aluminium and column is made of extruded aluminium. The top plate for mounting the tabletop to the base, is made from flame cut steel. The tabletops are CNC milled. The tabletop in kunis breccia and estremoza marble is treated with a sealer.

COLOUR

Base
Black (RAL 9005)

Tabletop
Black (RAL 9005)
Charcoal (RAL 7012)

TEST
EN 15372:2016, L2

MATERIALS & MAINTENANCE
Please see page 486 for materials and care and maintenance instructions.

DINING TABLE Ø60

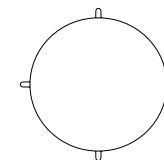

Ø: 60 cm / 23,6"

H: 73 cm / 28,7"

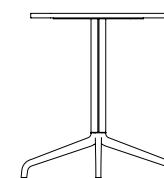

DINING TABLE Ø80

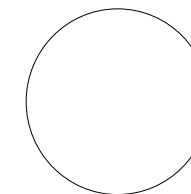

Ø: 80 cm / 31,5"

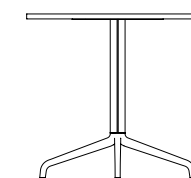

DINING TABLE Ø105

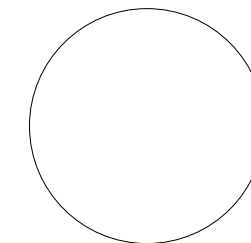

Ø: 105 cm / 41,3"

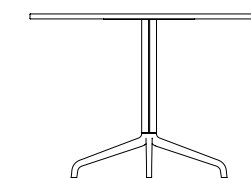

DINING TABLE 70X60



W: 70 cm / 27,6"

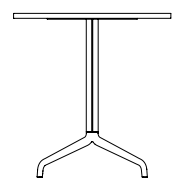









D: 60 cm / 23,6"

Harbour Column Dining Table, Star Base

BY NORM ARCHITECTS

SPEC OPTIONS — PRICES IN EUR *Selected combinations 6–8 weeks delivery time.*

SKU	VARIANT	INCL. VAT	EXCL. VAT
Harbour Column Dining Table — Star base — Ø60			
9326149	 HARBOUR COLUMN DINING TABLE, STAR BASE, Ø60, BLACK ALUMINIUM & STEEL / CHARCOAL LINOLEUM (NEW)	749,95	627,56
9326539	 HARBOUR COLUMN DINING TABLE, STAR BASE, Ø60, BLACK ALUMINIUM & STEEL / BLACK OAK (NEW)	749,95	627,56
9326659	 HARBOUR COLUMN DINING TABLE, STAR BASE, Ø60, BLACK ALUMINIUM & STEEL / ESTREMOZ MARBLE (NEW)	949,95	794,92
9326139	 HARBOUR COLUMN DINING TABLE, STAR BASE, Ø60 CM, BLACK ALUMINIUM & STEEL / KUNIS BRECCIA STONE (NEW)	999,95	836,76
Harbour Column Dining Table — Star base — Ø80			
9327149	 HARBOUR COLUMN DINING TABLE, STAR BASE, Ø80, BLACK ALUMINIUM & STEEL / CHARCOAL LINOLEUM (NEW)	699,95	585,72
9327539	 HARBOUR COLUMN DINING TABLE, STAR BASE, Ø80, BLACK ALUMINIUM & STEEL / BLACK OAK (NEW)	699,95	585,72
9327659	 HARBOUR COLUMN DINING TABLE, STAR BASE, Ø80, BLACK ALUMINIUM & STEEL / ESTREMOZ MARBLE (NEW)	999,95	836,76
9327139	 HARBOUR COLUMN DINING TABLE, STAR BASE, Ø80, BLACK ALUMINIUM & STEEL / KUNIS BRECCIA STONE (NEW)	1.199,95	1.004,12

Harbour Column Dining Table, Star Base

BY NORM ARCHITECTS

SPEC OPTIONS — PRICES IN EUR *Selected combinations 6–8 weeks delivery time.*

SKU	VARIANT	INCL. VAT	EXCL. VAT
Harbour Column Dining Table — Star base — 70x60			
9325149	 HARBOUR COLUMN DINING TABLE, STAR BASE, 70X60, BLACK ALUMINIUM & STEEL / CHARCOAL LINOLEUM (NEW)	749,95	627,56
9325539	 HARBOUR COLUMN DINING TABLE, STAR BASE, 70X60, BLACK ALUMINIUM & STEEL / BLACK OAK (NEW)	749,95	627,56
9325659	 HARBOUR COLUMN DINING TABLE, STAR BASE, 70X60, BLACK ALUMINIUM & STEEL / ESTREMOZ MARBLE (NEW)	949,95	794,92
9325139	 HARBOUR COLUMN DINING TABLE, STAR BASE, 70X60, BLACK ALUMINIUM & STEEL / KUNIS BRECCIA STONE (NEW)	999,95	836,76

Harbour Column Counter/Bar Table

BY NORM ARCHITECTS

Black powder coated aluminium and steel base in two heights with round or rectangular tabletop in kunis breccia, estremoze marble, black painted oak or linoleum.



PRODUCT OPTIONS

TABLETOP



BLACK PAINTED OAK



CHARCOAL LINOLEUM



ESTREMOZ MARBLE

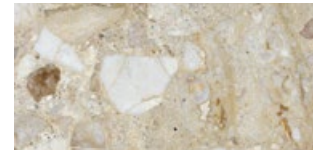

KUNIS BRECCIA STONE

BASE



BLACK POWDER COATED ALUMINIUM & STEEL

Harbour Column Bar Table, Black Steel / Charcoal Linoleum, by Norm Architects
Harbour Bar Chair, Black Steel / Hallingdal 65 0270, by Norm Architects

Harbour Column Counter/Bar Table

BY NORM ARCHITECTS

TECHNICAL SPECIFICATIONS

PRODUCT TYPE

Counter and bar table

ENVIRONMENT

Indoor

DIMENSIONS

Counter

H: 93 cm / 36,6"
Ø: 60 cm / 23,6"

H: 93 cm / 36,6"
Ø: 80 cm / 31,5"

H: 93 cm / 36,6"
W: 70 cm / 27,6"
D: 60 cm / 23,6"

Bar

H: 103 cm / 40,6"
Ø: 60 cm / 23,6"

H: 103 cm / 40,6"
Ø: 80 cm / 31,5"

H: 103 cm / 40,6"
W: 70 cm / 27,6"
D: 60 cm / 23,6"

PRODUCTION PROCESS

Both base and top plate for mounting the tabletop to the base are made from flame-cut steel. The column is made of extruded aluminium. Tabletops are CNC milled and kunis breccia and estremoze marble versions are treated with a sealer.

COLOUR

Base

Black (RAL 9005)

Tabletop

Black (RAL 9005)
Charcoal (RAL 7012)
Off white (Estremoze marble)
Sand (Kunis breccia)

GLOSS

Gloss 10-20

MATERIALS

Base

Cast, extruded aluminium, steel.

Tabletop

Kunis breccia stone, estremoze marble, MDF and forbo linoleum or MDF and painted oak veneer.

WEIGHT

Base

Ø50: 12,9 kg / 28,4 lb

Column Counter
3 kg / 6,6 lb

Column Bar
3,3 kg / 7,3 lb

Topplate

6,4 kg / 14,1 lb

Tabletop oak or linoleum

Ø60: 8 kg / 17,6 lb
Ø80: 9 kg / 19,8 lb
70x60: 8,5 kg / 18,7 lb

Tabletop marble or stone

Ø60: 28 kg / 61,7 lb
Ø80: 52,8 kg / 116,4 lb
70x60: 36 kg / 79,4 lb

TEST

EN 15372:2016, L2

CERTIFICATIONS

TSCA title VI compliant

PACKAGING TYPE

Brown box

PACKAGING MEASUREMENTS (H x W x D)

Base Ø50

6 cm x 58 cm x 58 cm / 2,4" x 22,8" x 22,8"

Column Counter (H x Ø)

105 cm x 7 cm / 41,3" x 2,8"

Column Bar (H x Ø)

105 cm x 7 cm / 41,3" x 2,8"

Topplate Ø40

6 cm x 48 cm x 48 cm / 2,4" x 18,9" x 18,9"

Tabletop oak or linoleum Ø60

6 cm x 65 cm x 65 cm / 2,4" x 25,6" x 25,6"

Tabletop oak or linoleum Ø80

6 cm x 85 cm x 85 cm / 2,4" x 33,5" x 33,5"

Tabletop oak or linoleum 70x60

6 cm x 75 cm x 65 cm / 2,4" x 29,5" x 25,6"

Tabletop marble or stone Ø60

70 cm x 70 cm x 10 cm / 27,6" x 27,6" x 4"

Tabletop marble or stone Ø80

90 cm x 90 cm x 10 cm / 35,4" x 35,4" x 4"

Tabletop marble or stone 70x60

80 cm x 70 cm x 10 cm / 31,5" x 27,6" x 4"

MATERIALS & MAINTENANCE

Please see page 486 for materials and care and maintenance instructions.

HARBOUR COLUMN COUNTER TABLE

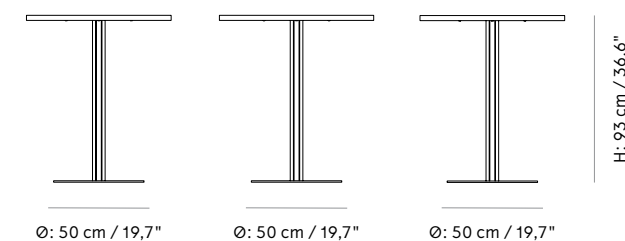
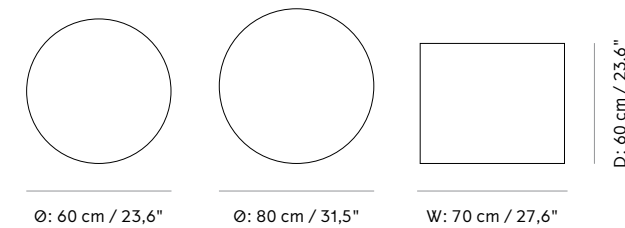



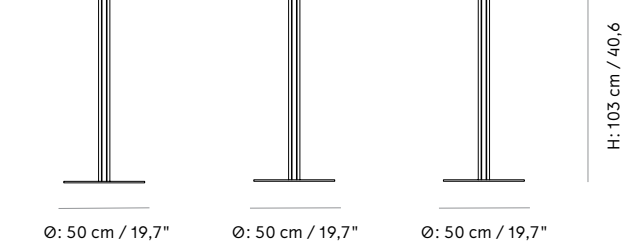
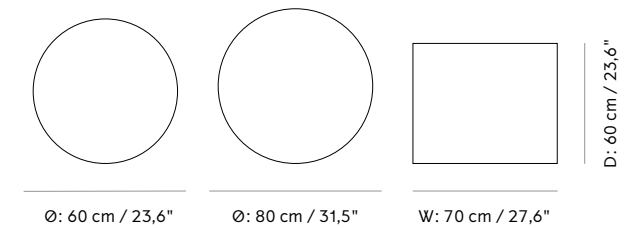





HARBOUR COLUMN BAR TABLE



Harbour Column Counter Table

BY NORM ARCHITECTS

SPEC OPTIONS — PRICES IN EUR *Selected combinations 6–8 weeks delivery time.*

SKU	VARIANT	INCL. VAT	EXCL. VAT
Harbour Column Counter Table — Ø60			
9318149	 HARBOUR COLUMN COUNTER TABLE, Ø60, BLACK ALUMINIUM & STEEL / CHARCOAL LINOLEUM	599,95	502,04
9318539	 HARBOUR COLUMN COUNTER TABLE, Ø60, BLACK ALUMINIUM & STEEL / BLACK OAK	599,95	502,04
9318659	 HARBOUR COLUMN COUNTER TABLE, Ø60, BLACK ALUMINIUM & STEEL / ESTREMOZ MARBLE	899,95	753,08
9318139	 HARBOUR COLUMN COUNTER TABLE, Ø60, BLACK ALUMINIUM & STEEL / KUNIS BRECCIA STONE (NEW)	999,95	836,76
Harbour Column Counter Table — Ø80			
9306149	 HARBOUR COLUMN COUNTER TABLE, Ø80, BLACK ALUMINIUM & STEEL / CHARCOAL LINOLEUM	699,95	585,72
9306539	 HARBOUR COLUMN COUNTER TABLE, Ø80, BLACK ALUMINIUM & STEEL / BLACK OAK	699,95	585,72
9306659	 HARBOUR COLUMN COUNTER TABLE, Ø80, BLACK ALUMINIUM & STEEL / ESTREMOZ MARBLE	1.099,95	920,44
9306139	 HARBOUR COLUMN COUNTER TABLE, Ø80, BLACK ALUMINIUM & STEEL / KUNIS BRECCIA STONE (NEW)	1.199,95	1.004,12

Harbour Column Counter Table

BY NORM ARCHITECTS









SPEC OPTIONS — PRICES IN EUR *Selected combinations 6–8 weeks delivery time.*

SKU	VARIANT	INCL. VAT	EXCL. VAT
Harbour Column Counter Table — 70x60			
9309149	 HARBOUR COLUMN COUNTER TABLE, 70X60, BLACK ALUMINIUM & STEEL / CHARCOAL LINOLEUM	599,95	502,04
9309539	 HARBOUR COLUMN COUNTER TABLE, 70X60, BLACK ALUMINIUM & STEEL / BLACK OAK	599,95	502,04
9309659	 HARBOUR COLUMN COUNTER TABLE, 70X60, BLACK ALUMINIUM & STEEL / ESTREMOZ MARBLE	899,95	753,08
9309139	 HARBOUR COLUMN COUNTER TABLE, 70X60, BLACK ALUMINIUM & STEEL / KUNIS BRECCIA STONE (NEW)	999,95	836,76

Harbour Column Bar Table

BY NORM ARCHITECTS





SPEC OPTIONS — PRICES IN EUR *Selected combinations 6–8 weeks delivery time.*

SKU	VARIANT	INCL. VAT	EXCL. VAT
Harbour Column Bar Table — Ø60			
9320149	 HARBOUR COLUMN BAR TABLE, Ø60, BLACK ALUMINIUM & STEEL / CHARCOAL LINOLEUM	599,95	502,04
9320539	 HARBOUR COLUMN BAR TABLE, Ø60, BLACK ALUMINIUM & STEEL / BLACK OAK	599,95	502,04
9320659	 HARBOUR COLUMN BAR TABLE, Ø60, BLACK ALUMINIUM & STEEL / ESTREMOZ MARBLE	899,95	753,08
9320139	 HARBOUR COLUMN BAR TABLE, Ø60, BLACK ALUMINIUM & STEEL / KUNIS BRECCIA	999,95	836,76
Harbour Column Bar Table— Ø80			
9307149	 HARBOUR COLUMN BAR TABLE, Ø80, BLACK ALUMINIUM & STEEL / CHARCOAL LINOLEUM	699,95	585,72
9307539	 HARBOUR COLUMN BAR TABLE, Ø80, BLACK ALUMINIUM & STEEL / BLACK OAK	699,95	585,72
9307659	 HARBOUR COLUMN BAR TABLE, Ø80, BLACK ALUMINIUM & STEEL/ ESTREMOZ MARBLE	1.099,95	920,44
9307139	 HARBOUR COLUMN BAR TABLE, Ø80, BLACK ALUMINIUM & STEEL / KUNIS BRECCIA STONE (NEW)	1.199,95	1.004,12

Harbour Column Bar Table

BY NORM ARCHITECTS

SPEC OPTIONS — PRICES IN EUR *Selected combinations 6–8 weeks delivery time.*

SKU	VARIANT	INCL. VAT	EXCL. VAT
Harbour Column Bar Table — 70x60			
9310149	 HARBOUR COLUMN BAR TABLE, 70X60, BLACK ALUMINIUM & STEEL / CHARCOAL LINOLEUM	599,95	502,04
9310539	 HARBOUR COLUMN BAR TABLE, 70X60, BLACK ALUMINIUM & STEEL / BLACK OAK	599,95	502,04
9310659	 HARBOUR COLUMN BAR TABLE, 70X60, BLACK ALUMINIUM & STEEL / ESTREMOZ MARBLE	899,95	753,08
9310139	 HARBOUR COLUMN BARR TABLE, 70X60, BLACK ALUMINIUM & STEEL / KUNIS BRECCIA STONE (NEW)	999,95	836,76

Harbour Column Counter/Bar Table, Star Base

BY NORM ARCHITECTS

Star-shaped, black powder coated aluminium and steel base in two heights with round or rectangular tabletop in kunis breccia, estremoze marble, black painted oak or linoleum.

PRODUCT OPTIONS

TABLETOP

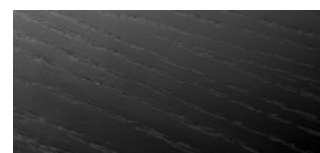

BLACK PAINTED OAK

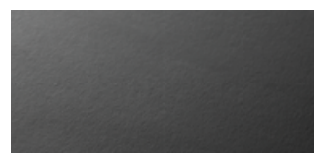

CHARCOAL LINOLEUM



ESTREMOZ MARBLE



KUNIS BRECCIA STONE

BASE



BLACK POWDER COATED ALUMINIUM & STEEL



Harbour Column Bar Table, Black Steel / Charcoal Linoleum, by Norm Architects
Harbour Bar Chair, Black Steel / Hallingdal 65 0270, by Norm Architects

Harbour Column Counter/Bar Table, Star Base

BY NORM ARCHITECTS

TECHNICAL SPECIFICATIONS

PRODUCT TYPE

Counter and bar table

ENVIRONMENT

Indoor

DIMENSIONS

Counter

H: 93 cm / 36,6"
Ø: 60 cm / 23,6"

H: 93 cm / 36,6"
Ø: 80 cm / 31,5"

H: 93 cm / 36,6"
W: 70 cm / 27,6"
D: 60 cm / 23,6"

Bar

H: 103 cm / 40,6"
Ø: 60 cm / 23,6"

H: 103 cm / 40,6"
Ø: 80 cm / 31,5"

H: 103 cm / 40,6"
W: 70 cm / 27,6"
D: 60 cm / 23,6"

PRODUCTION PROCESS

Star base is made of die casted aluminium and column is made of extruded aluminium. The top plate for mounting the tabletop to the base, is made from flame cut steel. The tabletops are CNC milled. The tabletop in kunis breccia and estremoze marble is treated with a sealer.

COLOUR

Base
Black (RAL 9005)

Tabletop
Black (RAL 9005)
Charcoal (RAL 7012)
Off white (Estremoze marble)
Sand (Kunis breccia)

GLOSS
Gloss 10,20

MATERIALS

Base
Cast, extruded aluminium, steel

Tabletop
Kunis breccia stone, estremoze marble, MDF and forbo linoleum or MDF and painted oak veneer.

WEIGHT

Star Base
3,5 kg / 7,7 lb

Column Counter
2,5 kg / 5,5 lb

Column Bar
2,8 kg / 6,2 lb

Topplate
6,4 kg / 14,1 lb

Tabletop oak or linoleum
Ø60: 8 kg / 17,6 lb
Ø80: 9 kg / 19,8 lb
70x60: 8,5 kg / 18,7 lb

Tabletop marble or stone
Ø60: 28 kg / 61,7 lb
Ø80: 52,8 kg / 116,4 lb
70x60: 36 kg / 79,4 lb

TEST
N / A

CERTIFICATIONS
TSCA title VI compliant

PACKAGING TYPE

Brown box

PACKAGING MEASUREMENTS (H x W x D)

Star Base
22 cm x 51 cm x 51 cm / 8,7" x 20,1" x 20,1"

Column Counter (H x Ø)
75 cm x 7 cm / 29,5" x 2,8"

Column Bar (H x Ø)
105 cm x 7 cm / 21,7" x 2,8"

Topplate
6 cm x 48 cm x 48 cm / 2,4" x 18,9" x 18,9"

Tabletop oak or linoleum Ø60
6 cm x 65 cm x 65 cm / 2,4" x 25,6" x 25,6"

Tabletop oak or linoleum Ø80
6 cm x 85 cm x 85 cm / 2,4" x 33,5" x 33,5"

Tabletop oak or linoleum 70x60
6 cm x 75 cm x 65 cm / 2,4" x 29,5" x 25,6"

Tabletop marble or stone Ø60
70 cm x 70 cm x 10 cm / 27,6" x 27,6" x 4"

Tabletop marble or stone Ø80
90 cm x 90 cm x 10 cm / 35,4" x 35,4" x 4"

Tabletop marble or stone 70x60
80 cm x 70 cm x 10 cm / 31,5" x 27,6" x 4"

MATERIALS & MAINTENANCE
Please see page 486 for materials and care and maintenance instructions.

HARBOUR COLUMN COUNTER TABLE, STAR BASE

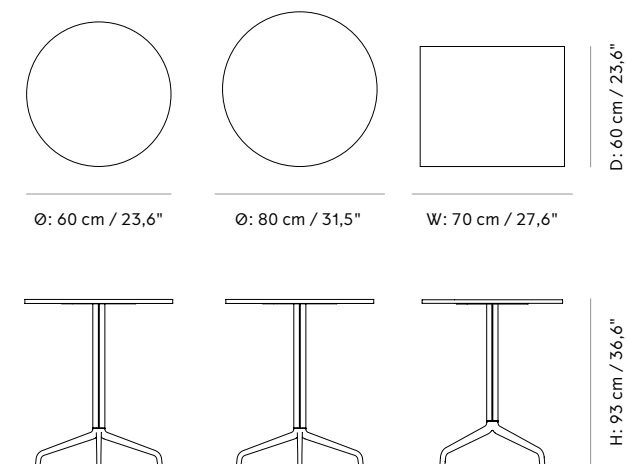



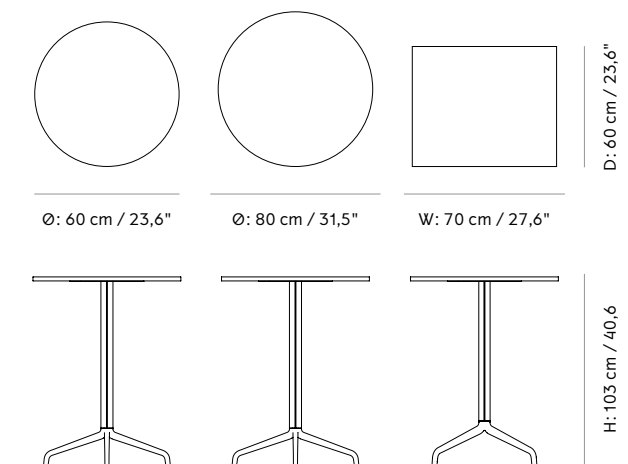





HARBOUR COLUMN BAR TABLE, STAR BASE



Harbour Column Counter Table, Star Base

BY NORM ARCHITECTS

SPEC OPTIONS — PRICES IN EUR *Selected combinations 6–8 weeks delivery time.*

SKU	VARIANT	INCL. VAT	EXCL. VAT
Harbour Column Counter Table — Star base — Ø60			
9331149	 HARBOUR COLUMN COUNTER TABLE, STAR BASE, Ø60, BLACK ALUMINIUM & STEEL / CHARCOAL LINOLEUM (NEW)	699,95	585,72
9331539	 HARBOUR COLUMN COUNTER TABLE, STAR BASE, Ø60, BLACK ALUMINIUM & STEEL / BLACK OAK (NEW)	699,95	585,72
9331659	 HARBOUR COLUMN COUNTER TABLE, STAR BASE, Ø60, BLACK ALUMINIUM & STEEL / ESTREMOZ MARBLE (NEW)	999,95	836,76
9331139	 HARBOUR COLUMN COUNTER TABLE, STAR BASE, Ø60, BLACK ALUMINIUM & STEEL / KUNIS BRECCIA STONE (NEW)	1.199,95	1.004,12
Harbour Column Counter Table — Star base — Ø80			
9332149	 HARBOUR COLUMN COUNTER TABLE, STAR BASE, Ø80, BLACK ALUMINIUM & STEEL / CHARCOAL LINOLEUM (NEW)	899,95	753,08
9332539	 HARBOUR COLUMN COUNTER TABLE, STAR BASE, Ø80, BLACK ALUMINIUM & STEEL / BLACK OAK (NEW)	899,95	753,08
9332659	 HARBOUR COLUMN COUNTER TABLE, STAR BASE, Ø80, BLACK ALUMINIUM & STEEL / ESTREMOZ MARBLE (NEW)	1.199,95	1.004,12
9332139	 HARBOUR COLUMN COUNTER TABLE, STAR BASE, Ø80, BLACK ALUMINIUM & STEEL / KUNIS BRECCIA STONE (NEW)	1.349,95	1.129,64

Harbour Column Counter Table, Star Base

BY NORM ARCHITECTS









SPEC OPTIONS — PRICES IN EUR *Selected combinations 6–8 weeks delivery time.*

SKU	VARIANT	INCL. VAT	EXCL. VAT
Harbour Column Counter Table — Star base — 70x60			
9330149	 HARBOUR COLUMN COUNTER TABLE, STAR BASE, 70X60, BLACK ALUMINIUM & STEEL / CHARCOAL LINOLEUM (NEW)	699,95	585,72
9330539	 HARBOUR COLUMN COUNTER TABLE, STAR BASE, 70X60, BLACK ALUMINIUM & STEEL / BLACK OAK (NEW)	699,95	585,72
9330659	 HARBOUR COLUMN COUNTER TABLE, STAR BASE, 70X60, BLACK ALUMINIUM & STEEL / ESTREMOZ MARBLE (NEW)	999,95	836,76
9330139	 HARBOUR COLUMN COUNTER TABLE, STAR BASE, 70X60, BLACK ALUMINIUM & STEEL / KUNIS BRECCIA STONE (NEW)	1.199,95	1.004,12

Harbour Column Bar Table, Star Base

BY NORM ARCHITECTS





SPEC OPTIONS — PRICES IN EUR *Selected combinations 6–8 weeks delivery time.*

SKU	VARIANT	INCL. VAT	EXCL. VAT
Harbour Column Bar Table — Star base — Ø60			
9336149	 HARBOUR COLUMN BAR TABLE, STAR BASE, Ø60, BLACK ALUMINIUM & STEEL / CHARCOAL LINOLEUM (NEW)	699,95	585,72
9336539	 HARBOUR COLUMN BAR TABLE, STAR BASE, Ø60, BLACK ALUMINIUM & STEEL / BLACK OAK (NEW)	699,95	585,72
9336659	 HARBOUR COLUMN BAR TABLE, STAR BASE, Ø60, BLACK ALUMINIUM & STEEL / ESTREMOZ MARBLE (NEW)	999,95	836,76
9336139	 HARBOUR COLUMN BAR TABLE, STAR BASE, Ø60, BLACK ALUMINIUM & STEEL / KUNIS BRECCIA STONE (NEW)	1.199,95	1.004,12
Harbour Column Bar Table — Star base — Ø80			
9337149	 HARBOUR COLUMN BAR TABLE, STAR BASE, Ø80, BLACK ALUMINIUM & STEEL / CHARCOAL LINOLEUM (NEW)	899,95	753,08
9337539	 HARBOUR COLUMN BAR TABLE, STAR BASE, Ø80, BLACK ALUMINIUM & STEEL / BLACK OAK (NEW)	899,95	753,08
9337659	 HARBOUR COLUMN BAR TABLE, STAR BASE, Ø80, BLACK ALUMINIUM & STEEL / ESTREMOZ MARBLE (NEW)	1.199,95	1.004,12
9337139	 HARBOUR COLUMN BAR TABLE, STAR BASE, Ø80, BLACK ALUMINIUM & STEEL / KUNIS BRECCIA STONE (NEW)	1.349,95	1.129,64

Harbour Column Bar Table, Star Base

BY NORM ARCHITECTS

SPEC OPTIONS — PRICES IN EUR *Selected combinations 6–8 weeks delivery time.*

SKU	VARIANT	INCL. VAT	EXCL. VAT
Harbour Column Bar Table — Star base — 70x60			
9335149	 HARBOUR COLUMN BAR TABLE, STAR BASE, 70X60, BLACK ALUMINIUM & STEEL / CHARCOAL LINOLEUM (NEW)	699,95	585,72
9335539	 HARBOUR COLUMN BAR TABLE, STAR BASE, 70X60, BLACK ALUMINIUM & STEEL / BLACK OAK (NEW)	699,95	585,72
9335659	 HARBOUR COLUMN BAR TABLE, STAR BASE, 70X60, BLACK ALUMINIUM & STEEL / ESTREMOZ MARBLE (NEW)	999,95	836,76
9335139	 HARBOUR COLUMN BAR TABLE, STAR BASE, 70X60, BLACK ALUMINIUM & STEEL / KUNIS BRECCIA STONE (NEW)	1.199,95	1.004,12

Co Chair

BY NORM ARCHITECTS & ELS VAN HOOREBEECK

Chair with black powder coated or chromed steel base with curved wood veneer seat, backrest and armrest in natural, dark stained or black oak. Available with or without upholstery seat and with or without armrest.



PRODUCT OPTIONS

SEAT



WITHOUT UPHOLSTERY

WITH UPHOLSTERY

BACKREST AND ARMREST

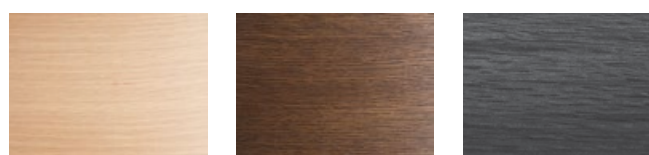

NATURAL OAK

DARK STAINED OAK

BLACK OAK

STEEL BASE



BLACK POWDER COATED STEEL

CHROMED STEEL

WITH OR WITHOUT ARMREST

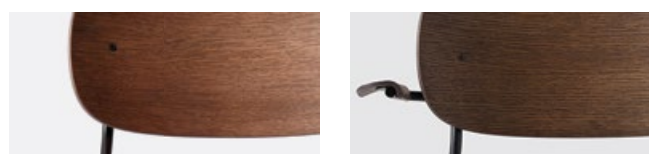

WITHOUT ARMREST

WITH ARMREST

SPEC OPTIONS

Available in fabrics from our upholstery programme. Standard lead times apply. Custom upholstery available upon request. For further information please refer to MENU Upholstery Programme.

Co Chair w/Armrest, Black Steel / Natural Oak, by Norm Architects & Els Van Hoorebeek
Co Chair w/Armrest, Black Steel/Dark Stained Oak / Dakar 0842, by Norm Architects & Els Van Hoorebeek



Co Chair

BY NORM ARCHITECTS & ELS VAN HOOREBEECK

TECHNICAL SPECIFICATIONS

PRODUCT TYPE

Dining chair

ENVIRONMENT

Indoor

DIMENSIONS

Without armrest

H: 80 cm / 31,5"
SH: 45 cm / 17,7"
D: 50,5 cm / 19,9"
W: 52 cm / 20,5"

With armrest

H: 80 cm / 31,5"
AH: 68 cm / 26,8"
SH: 45 cm / 17,7"
D: 50,5 cm / 19,9"
W: 62 cm / 24,4"

PRODUCTION PROCESS

Seat, backrest and armrests are made of curved plywood. Shell is are CNC-milled in a 5-axis CNC machine. The core is made of beech veneer with an outer layer of oak veneer. Double layer foam is used on upholstered seats for added comfort. The base is made of bent, MIG+TIG-welded steel tubes and armrests from steel rods. The base and armrest are powder coated or chromed.

COLOUR

Seat without upholstery

Black (RAL 9005) / Natural oak
Black (RAL 9005) / Dark stained oak
Black (RAL 9005) / Black oak
Chrome / Natural oak
Chrome / Dark stained oak
Chrome / Black oak

Seat with upholstery

Dependent upon selected upholstery.

GLOSS

Gloss 10-20

MATERIALS

Seat, backrest and armrests

Natural oak veneer with matte lacquer; dark stained oak; wax stained or black painted oak; beech core.

Seat with upholstery

Beech plywood, CAL117 foam (20mm 45N / 40 kg and 10mm 32N / 40 kg), upholstery.

Base

Powder coated or chromed steel.

WEIGHT

Without armrest: 8 kg / 17,6 lb
Without armrest, with upholstery: 8,5 kg / 18,7 lb
With armrest: 12 kg / 26,5 lb
With armrest, with upholstery: 12,5 kg / 27,5 lb

TEST

EN1022:2005, L2
EN16139:2013, L2

CERTIFICATIONS

FSC certified, ENL 14001

PACKAGING TYPE

Brown box

PACKAGING MEASUREMENTS (H x W x D)

Without armrest

86 cm x 58 cm x 53 cm / 33,9" x 22,8" x 20,9"

With armrest

86 cm x 58 cm x 67 cm / 33,9" x 22,8" x 26,4"

MATERIALS & MAINTENANCE

Please see page 486 for materials and care and maintenance instructions.

CO CHAIR, WITHOUT ARMREST

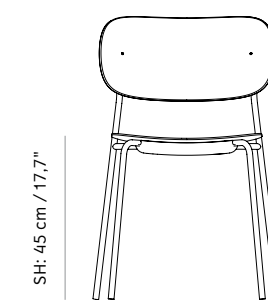

W: 52 cm / 20,5"

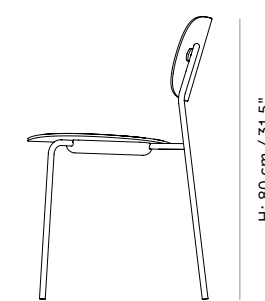

D: 50,5 cm / 19,9"

CO CHAIR, WITH ARMREST

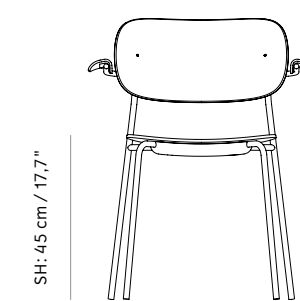

W: 62 cm / 24,4"

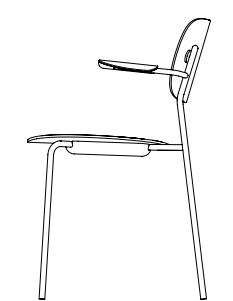



D: 50,5 cm / 19,9"



Co Chair

BY NORM ARCHITECTS & ELS VAN HOOREBEECK

STOCK OPTIONS — PRICES IN EUR *Selected combinations up to 2 weeks delivery time.*

SKU	VARIANT	INCL. VAT	EXCL. VAT
Seat without upholstery — Powder coated steel base — Black steel — Oak backrest — Natural oak / Dark stained oak / Black oak			
1160849	 CO CHAIR, BLACK STEEL / DARK STAINED OAK	299,95	251,00
1161539	 CO CHAIR, BLACK STEEL / BLACK OAK	299,95	251,00
Seat with upholstery — Powder coated steel base — Black steel — Oak backrest — Dark stained oak / Black oak			
1167539	 CO CHAIR, BLACK STEEL / BLACK OAK / DAKAR 0842	459,95	384,89

QUICK SHIP OPTIONS — PRICES IN EUR *Selected combinations up to 4 weeks delivery time.*







SKU	VARIANT	INCL. VAT	EXCL. VAT
Seat without upholstery — Powder coated steel base — Black steel — Oak backrest — Natural oak / Dark stained oak / Black oak			
1160039	 CO CHAIR, BLACK STEEL / NATURAL OAK	299,95	251,00
Seat with upholstery — Powder coated steel base — Black steel — Oak backrest — Dark stained oak / Black oak			
1166849	 CO CHAIR, BLACK STEEL / DARK STAINED OAK / CITY VELVET CA7832/062	399,95	334,68
1167849	 CO CHAIR, BLACK STEEL / DARK STAINED OAK / DAKAR 0842	459,95	384,89

Additional charge of 10% for CMHR foam in accordance with UK requirement.
Option to upholster with customer's own fabric available upon request. For further information please see our upholstery programme on page 464.

Co Chair

BY NORM ARCHITECTS & ELS VAN HOOREBEECK

RECOMMENDED COMBINATIONS — PRICES IN EUR *Selected combinations 6–8 weeks delivery time.*









SKU	VARIANT	INCL. VAT	EXCL. VAT
Seat with upholstery — Powder coated steel base — Black steel — Oak backrest — Natural oak / Dark stained oak / Black oak			
1167069	 CO CHAIR, BLACK STEEL / DARK STAINED OAK / MAPLE 222	399,95	334,68
1173939	 CO CHAIR, BLACK STEEL / NATURAL OAK / GAJA C2C 61114	399,95	334,68
1167979	 CO CHAIR, BLACK STEEL / NATURAL OAK / DAKAR 0250	459,95	384,89
1173559	 CO CHAIR, BLACK STEEL / BLACK OAK / DAKAR 0842	459,95	384,89
1173839	 CO CHAIR, BLACK STEEL / DARK STAINED OAK / RITZ 1644	459,95	384,89
1173049	 CO CHAIR, BLACK STEEL / DARK STAINED OAK / LUPO SAND T19028/004 (NEW)	599,95	502,04
1173549	 CO CHAIR, BLACK STEEL / BLACK OAK / DOPPIOPANAMA T14012/001 (NEW)	599,95	502,04

Additional charge of 10% for CMHR foam in accordance with UK requirement.
Option to upholster with customer's own fabric available upon request. For further information please see our upholstery programme on page 464.

Co Chair

BY NORM ARCHITECTS & ELS VAN HOOREBEECK

RECOMMENDED COMBINATIONS — PRICES IN EUR *Selected combinations 6–8 weeks delivery time.*

SKU	VARIANT	INCL. VAT	EXCL. VAT
Seat without upholstery — Chromed steel base — Chrome — Oak backrest — Natural oak / Dark stained oak / Black oak			
1172019	 CO CHAIR, CHROME / NATURAL OAK (NEW)	349,95	292,84
1172849	 CO CHAIR, CHROME / DARK STAINED OAK (NEW)	349,95	292,84
1172539	 CO CHAIR, CHROME / BLACK OAK (NEW)	349,95	292,84
Seat with upholstery — Chromed steel base — Chrome — Oak backrest — Natural oak / Dark stained oak / Black oak			
1172939	 CO CHAIR, CHROME / NATURAL OAK / GAJA C2C 61114 (NEW)	449,95	376,52
1172839	 CO CHAIR, CHROME / DARK STAINED OAK / RITZ 1644 (NEW)	499,95	418,36
1172559	 CO CHAIR, CHROME / BLACK OAK / DAKAR 0842 (NEW)	499,95	418,36
1172979	 CO CHAIR, CHROME / NATURAL OAK / DAKAR 0250 (NEW)	499,95	418,36
1172549	 CO CHAIR, CHROME / BLACK OAK / DOPPIOPANAMA T14012/001 (NEW)	679,95	568,98
1172049	 CO CHAIR, CHROME / DARK STAINED OAK / LUPO SAND T19028/004 (NEW)	679,95	568,98

Additional charge of 10% for CMHR foam in accordance with UK requirement.
Option to upholster with customer's own fabric available upon request. For further information please see our upholstery programme on page 464.



Duca Candleholder, Bronzed Brass, by Krøyer-Sætter-Lassen
Duca Candleholder, Polished Brass, by Krøyer-Sætter-Lassen
JWDA Floor Lamp, Carrara Marble / Bronzed Brass, by Jonas Wagell
Co Chair, Black Steel / Dark Stained Oak/
Shade Pitch Black, by Norm Architects & Els Van Hoorebeeck

Co Chair

BY NORM ARCHITECTS & ELS VAN HOOREBEECK

SPEC OPTIONS — PRICES IN EUR *Selected combinations 6–8 weeks delivery time.*

SKU	VARIANT	INCL. VAT	EXCL. VAT
Textile — Seat with upholstery — Powder coated steel base — Black — Oak backrest — Natural oak / Dark stained oak / Black oak			
1160001	PRICE CATEGORY 1 Maple, Kvadrat / Remix 2, Kvadrat / City Velvet, JAB / Hot Madison Reloaded, JAB / Gaja C2C, Gabriel / Champion, Kvadrat	399,95	334,68
1160002	PRICE CATEGORY 2 Hallingdal 65, Kvadrat / Savanna, Kvadrat / Colline, Kvadrat / Canvas, Kvadrat / Ritz, Nevotex / Fiord, Kvadrat / Steelcut 2, Kvadrat / Steelcut Trio 3, Kvadrat / Moss, Kvadrat / Clay, Kvadrat / Divina Melange, Kvadrat	459,95	384,89
1160003	PRICE CATEGORY 3 Vintage, Astrid / Safire, Kvadrat / Satoriale Collection: Grisaille, Dedar / Ponpon, Dedar	519,95	435,09
1160008	PRICE CATEGORY 4 (NEW) Satoriale Collection: Doppioanama, Dedar / Deco, Dedar Texturologie Collection: Lupo, Dedar / Atlas, Dedar	599,95	502,04
Leather — Seat with upholstery — Powder coated steel base — Black — Oak backrest — Natural oak / Dark stained oak / Black oak			
1160004	PRICE CATEGORY 1 Ultra, Sørensen Leather / Dakar, Nevotex	459,95	384,89
1160005	PRICE CATEGORY 2 Dunes, Sørensen Leather / Shade, Sørensen Leather / Nuance, Sørensen Leather / Instill, Kvadrat	539,95	451,83
1160006	PRICE CATEGORY 3 Royal Nubuck, Sørensen Leather	619,95	518,77
1160007	PRICE CATEGORY 4 Elegance, Sørensen Leather	799,95	669,40

Additional charge of 10% for CMHR foam in accordance with UK requirement.
Option to upholster with customer's own fabric available upon request. For further information please see our upholstery programme on page 464.

Co Chair

BY NORM ARCHITECTS & ELS VAN HOOREBEECK

SPEC OPTIONS — PRICES IN EUR *Selected combinations 6–8 weeks delivery time.*





SKU	VARIANT	INCL. VAT	EXCL. VAT
Textile — Seat with upholstery — Chromed steel base — Chrome — Oak backrest — Natural oak / Dark stained oak / Black oak			
1172001	PRICE CATEGORY 1 (NEW) Maple, Kvadrat / Remix 2, Kvadrat / City Velvet, JAB / Hot Madison Reloaded, JAB / Gaja C2C, Gabriel / Champion, Kvadrat	449,95	376,52
1172002	PRICE CATEGORY 2 (NEW) Hallingdal 65, Kvadrat / Savanna, Kvadrat / Colline, Kvadrat / Canvas, Kvadrat / Ritz, Nevotex / Fiord, Kvadrat / Steelcut 2, Kvadrat / Steelcut Trio 3, Kvadrat / Moss, Kvadrat / Clay, Kvadrat / Divina Melange, Kvadrat	499,95	418,36
1172003	PRICE CATEGORY 3 (NEW) Vintage, Astrid / Safire, Kvadrat / Satoriale Collection: Grisaille, Dedar / Ponpon, Dedar	599,95	502,04
1172008	PRICE CATEGORY 4 (NEW) Satoriale Collection: Doppioanama, Dedar / Deco, Dedar Texturologie Collection: Lupo, Dedar / Atlas, Dedar	679,95	568,98
Leather — Seat with upholstery — Chromed steel base — Chrome — Oak backrest — Natural oak / Dark stained oak / Black oak			
1172004	PRICE CATEGORY 1 (NEW) Ultra, Sørensen Leather / Dakar, Nevotex	499,95	418,36
1172005	PRICE CATEGORY 2 (NEW) Dunes, Sørensen Leather / Shade, Sørensen Leather / Nuance, Sørensen Leather / Instill, Kvadrat	599,95	502,04
1172006	PRICE CATEGORY 3 (NEW) Royal Nubuck, Sørensen Leather	689,95	577,35
1172007	PRICE CATEGORY 4 (NEW) Elegance, Sørensen Leather	879,95	736,34

Additional charge of 10% for CMHR foam in accordance with UK requirement.
Option to upholster with customer's own fabric available upon request. For further information please see our upholstery programme on page 464.



Co Chair w/Armrest

BY NORM ARCHITECTS & ELS VAN HOOREBEECK

STOCK OPTIONS — PRICES IN EUR *Selected combinations up to 2 weeks delivery time.*

SKU	VARIANT	INCL. VAT	EXCL. VAT
Seat without upholstery — Powder coated steel base — Black steel — Oak backrest and armrest — Natural oak / Dark stained oak / Black oak			
1166539	 CO CHAIR W/ARMREST, BLACK STEEL / BLACK OAK	349,95	292,84
1165849	 CO CHAIR W/ARMREST, BLACK STEEL / DARK STAINED OAK	349,95	292,84
Seat with upholstery — Powder coated steel base — Black steel — Oak backrest and armrest — Natural oak / Dark stained oak / Black oak			
1169849	 CO CHAIR W/ARMREST, BLACK STEEL / DARK STAINED OAK / DAKAR 0842	529,95	443,46
1169539	 CO CHAIR W/ARMREST, BLACK STEEL / BLACK OAK / DAKAR 0842	529,95	443,46

QUICK SHIP OPTIONS — PRICES IN EUR *Selected combinations up to 4 weeks delivery time.*







SKU	VARIANT	INCL. VAT	EXCL. VAT
Seat without upholstery — Powder coated steel base — Black steel — Oak backrest and armrest — Natural oak / Dark stained oak / Black oak			
1165039	 CO CHAIR W/ARMREST, BLACK STEEL / NATURAL OAK	349,95	292,84
Seat with upholstery — Powder coated steel base — Black steel — Oak backrest and armrest — Natural oak / Dark stained oak / Black oak			
1168849	 CO CHAIR W/ARMREST, BLACK STEEL / DARK STAINED OAK / CITY VELVET CA7832/062	459,95	384,89

Additional charge of 10% for CMHR foam in accordance with UK requirement.
Option to upholster with customer's own fabric available upon request. For further information please see our upholstery programme on page 464.

Co Chair w/Armrest

BY NORM ARCHITECTS & ELS VAN HOOREBEECK

RECOMMENDED COMBINATIONS — PRICES IN EUR *Selected combinations 6–8 weeks delivery time.*

SKU	VARIANT	INCL. VAT	EXCL. VAT
Seat with upholstery — Powder coated steel base — Black steel — Oak backrest and armrest — Natural oak / Dark stained oak / Black oak			
1168069	 CO CHAIR W/ARMREST, BLACK STEEL / DARK STAINED OAK / MAPLE 222	459,95	384,89
1170539	 CO CHAIR W/ARMREST, BLACK STEEL / BLACK OAK / ICON 246	529,95	443,46
1169979	 CO CHAIR W/ARMREST, BLACK STEEL / NATURAL OAK / DAKAR 0250	529,95	443,46
1177049	 CO CHAIR W/ARMREST, BLACK STEEL / DARK STAINED OAK / LUPO SAND T19028/004 (NEW)	689,95	577,35
1177549	 CO CHAIR W/ARMREST, BLACK STEEL / BLACK OAK / DOPPIOPANAMA T14012/001 (NEW)	689,95	577,35
1177839	 CO CHAIR W/ARMREST, BLACK STEEL / DARK STAINED OAK / RITZ 1644	529,95	443,46
1177939	 CO CHAIR W/ARMREST, BLACK STEEL / NATURAL OAK / GAJA C2C 61114	459,95	384,89









Additional charge of 10% for CMHR foam in accordance with UK requirement.
Option to upholster with customer's own fabric available upon request. For further information please see our upholstery programme on page 464.

Co Chair w/Armrest

BY NORM ARCHITECTS & ELS VAN HOOREBEECK

Co Chair w/ Armrest, Chrome / Natural Oak / Dakar 0250,
by Norm Architects & Els Van Hoorebeeck

RECOMMENDED COMBINATIONS — PRICES IN EUR *Selected combinations 6–8 weeks delivery time.*

SKU	VARIANT	INCL. VAT	EXCL. VAT
Seat without upholstery — Chromed steel base — Chrome — Oak backrest and armrest — Natural oak / Dark stained oak / Black oak			
1176019	 CO CHAIR W/ARMREST, CHROME / NATURAL OAK (NEW)	419,95	351,41
1176849	 CO CHAIR W/ARMREST, CHROME / DARK STAINED OAK (NEW)	419,95	351,41
1176539	 CO CHAIR W/ARMREST, CHROME / BLACK OAK (NEW)	419,95	351,41
Seat with upholstery — Chromed steel base — Chrome — Oak backrest and armrest — Natural oak / Dark stained oak / Black oak			
1176939	 CO CHAIR W/ARMREST, CHROME / NATURAL OAK / GAJA C2C 61114 (NEW)	519,95	435,09
1176839	 CO CHAIR W/ARMREST, CHROME / DARK STAINED OAK / RITZ 1644 (NEW)	579,95	485,30
1176559	 CO CHAIR W/ARMREST, CHROME / BLACK OAK / DAKAR 0842 (NEW)	579,95	485,30
1176979	 CO CHAIR W/ARMREST, CHROME / NATURAL OAK / DAKAR 0250 (NEW)	579,95	485,30
1176549	 CO CHAIR W/ARMREST, CHROME / BLACK OAK / DOPPIOPANAMA T14012/001 (NEW)	779,95	652,66
1176049	 CO CHAIR W/ARMREST, CHROME / DARK STAINED OAK / LUPO SAND T19028/004 (NEW)	779,95	652,66

Additional charge of 10% for CMHR foam in accordance with UK requirement.
Option to upholster with customer's own fabric available upon request. For further information please see our upholstery programme on page 464.



Co Chair w/Armrest

BY NORM ARCHITECTS & ELS VAN HOOREBEECK

SPEC OPTIONS — PRICES IN EUR *Selected combinations 6–8 weeks delivery time.*

SKU	VARIANT	INCL. VAT	EXCL. VAT
Textile — Seat with upholstery — Powder coated steel base — Black steel — Oak Backrest and Armrest — Natural oak / Dark stained oak / Black oak			
1165001	PRICE CATEGORY 1 Maple, Kvadrat / Remix 2, Kvadrat / City Velvet, JAB / Hot Madison Reloaded, JAB / Gaja C2C, Gabriel / Champion, Kvadrat	579,95	485,30
1165002	PRICE CATEGORY 2 Hallingdal 65, Kvadrat / Savanna, Kvadrat / Colline, Kvadrat / Canvas, Kvadrat / Ritz, Nevotex / Fiord, Kvadrat / Steelcut 2, Kvadrat / Steelcut Trio 3, Kvadrat / Moss, Kvadrat / Clay, Kvadrat / Divina Melange, Kvadrat	459,95	384,89
1165003	PRICE CATEGORY 3 Vintage, Astrid / Safire, Kvadrat / Satoriale Collection: Grisaille, Dedar / Ponpon, Dedar	529,95	443,46
1165008	PRICE CATEGORY 4 (NEW) Satoriale Collection: Doppioanama, Dedar / Deco, Dedar Texturologie Collection: Lupo, Dedar / Atlas, Dedar	689,95	577,35
Leather — Seat with upholstery — Powder coated steel base — Black steel — Oak backrest and armrest — Natural oak / Dark stained oak / Black oak			
1165004	PRICE CATEGORY 1 Ultra, Sørensen Leather / Dakar, Nevotex	529,95	443,46
1165005	PRICE CATEGORY 2 Dunes, Sørensen Leather / Shade, Sørensen Leather / Nuance, Sørensen Leather / Instill, Kvadrat	629,95	527,14
1165006	PRICE CATEGORY 3 Royal Nubuck, Sørensen Leather	719,95	602,45
1165007	PRICE CATEGORY 4 Elegance, Sørensen Leather	919,95	769,81

Additional charge of 10% for CMHR foam in accordance with UK requirement.
Option to upholster with customer's own fabric available upon request. For further information please see our upholstery programme on page 464.

Co Chair w/Armrest

BY NORM ARCHITECTS & ELS VAN HOOREBEECK

SPEC OPTIONS — PRICES IN EUR *Selected combinations 6–8 weeks delivery time.*

SKU	VARIANT	INCL. VAT	EXCL. VAT
Textile — Seat with upholstery — Chromed steel base — Chrome — Oak backrest and armrest — Natural oak / Dark stained oak / Black oak			
1176001	PRICE CATEGORY 1 (NEW) Maple, Kvadrat / Remix 2, Kvadrat / City Velvet, JAB / Hot Madison Reloaded, JAB / Gaja C2C, Gabriel / Champion, Kvadrat	519,95	435,09
1176002	PRICE CATEGORY 2 (NEW) Hallingdal 65, Kvadrat / Savanna, Kvadrat / Colline, Kvadrat / Canvas, Kvadrat / Ritz, Nevotex / Fiord, Kvadrat / Steelcut 2, Kvadrat / Steelcut Trio 3, Kvadrat / Moss, Kvadrat / Clay, Kvadrat / Divina Melange, Kvadrat	579,95	485,30
1176003	PRICE CATEGORY 3 (NEW) Vintage, Astrid / Safire, Kvadrat / Satoriale Collection: Grisaille, Dedar / Ponpon, Dedar	649,95	543,88
1176008	PRICE CATEGORY 4 (NEW) Satoriale Collection: Doppioanama, Dedar / Deco, Dedar Texturologie Collection: Lupo, Dedar / Atlas, Dedar	779,95	652,66
Leather — Seat with upholstery — Chromed steel base — Chrome — Oak backrest and armrest — Natural oak / Dark stained oak / Black oak			
1176004	PRICE CATEGORY 1 (NEW) Ultra, Sørensen Leather / Dakar, Nevotex	579,95	485,30
1176005	PRICE CATEGORY 2 (NEW) Dunes, Sørensen Leather / Shade, Sørensen Leather / Nuance, Sørensen Leather / Instill, Kvadrat	679,95	568,98
1176006	PRICE CATEGORY 3 (NEW) Royal Nubuck, Sørensen Leather	769,95	644,29
1176007	PRICE CATEGORY 4 (NEW) Elegance, Sørensen Leather	969,95	811,65

Additional charge of 10% for CMHR foam in accordance with UK requirement.
Option to upholster with customer's own fabric available upon request. For further information please see our upholstery programme on page 464.

Co Lounge Chair

BY NORM ARCHITECTS & ELS VAN HOOREBEECK

Lounge chair with black powder coated steel base with upholstered seat, curved wood veneer backrest and armrest in natural oak, dark stained oak or black oak.



PRODUCT OPTIONS

BACKREST AND ARMREST

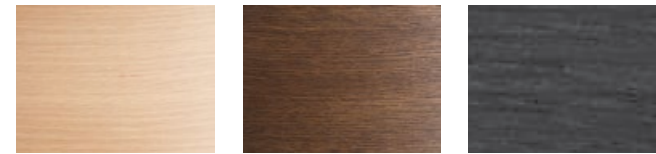

NATURAL OAK

DARK STAINED OAK

BLACK OAK

POWDER COATED STEEL BASE



BLACK STEEL

SPEC OPTIONS

Available in fabrics from our upholstery programme. Standard lead times apply. Custom upholstery available upon request. For further information please refer to MENU Upholstery Programme.



Co Lounge Chair, Black Steel / Natural Oak/Dakar 0250, by Norm Architects
Gravel Rug, Ivory, by Nina Bruun

Co Lounge Chair

BY NORM ARCHITECTS & ELS VAN HOOREBEECK

TECHNICAL SPECIFICATIONS

PRODUCT TYPE

Lounge chair

ENVIRONMENT

Indoor

DIMENSIONS

H: 71 cm / 28"

AH: 58 cm / 22,8"

SH: 41 cm / 16,1"

D: 66 cm / 26"

W: 70 cm / 27,5"

PRODUCTION PROCESS

Seat, backrest and armrests are made of curved plywood. The shell is CNC-milled in a 5-axis CNC machine. The core is made from beech veneer with an outer layer of oak veneer. Double layer foam is used on the upholstered seat for added comfort.

The base is made of bent, MIG+TIG-welded steel tubes and the armrests are made from steel rods. The base and armrest are powder coated. The seat is milled MDF with a painted finish. The upholstered seat and back is made from plywood shell, foam and upholstery.

COLOUR

Black (RAL 9005) / Natural oak / Upholstery

Black (RAL 9005) / Dark stained oak / Upholstery

Black (RAL 9005) / Black oak / Upholstery

GLOSS

Gloss 10-20

MATERIALS

Backrest and armrest

Natural oak veneer with matte lacquer, dark stained oak wax stained or black painted oak with matte lacquer and beech.

Seat with upholstery

Beech, plywood, CAL117 foam (30 mm 45N / 40 kg and 10 mm 32N / 40 kg), upholstery.

Base

Powder coated steel.

WEIGHT

8,5 kg / 18,7 lb

TEST

EN1022:2005, L2

EN16139:2013, L2

CERTIFICATIONS

FSC Certified, ENL 14001

PACKAGING TYPE

Brown box

PACKAGING MEASUREMENTS (H x W x D)

73 cm x 68 cm x 72 cm / 28,7" x 26,8" x 28,3"

MATERIALS & MAINTENANCE



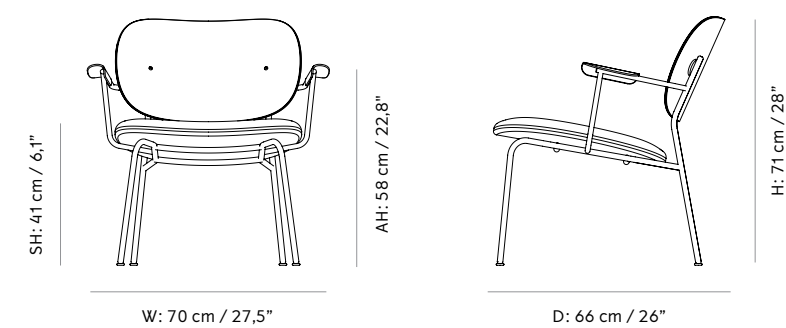

Please see page 486 for materials and care and maintenance instructions.



Co Lounge Chair

BY NORM ARCHITECTS & ELS VAN HOOREBEECK

RECOMMENDED COMBINATIONS — PRICES IN EUR *Selected combinations 6–8 weeks delivery time.*

SKU	VARIANT	INCL. VAT	EXCL. VAT
Seat with upholstery — Powder coated steel base — Black steel — Oak backrest and armrest — Natural oak / Dark stained oak / Black oak			
1192069	 CO CHAIR LOUNGE CHAIR, BLACK STEEL / DARK STAINED OAK / MAPLE 222	949,95	794,92
1193559	 CO CHAIR LOUNGE CHAIR, BLACK STEEL / BLACK OAK / DAKAR 0842	999,95	836,76
1191979	 CO CHAIR LOUNGE CHAIR, BLACK STEEL / NATURAL OAK / DAKAR 0250	999,95	836,76
1192469	 CO CHAIR LOUNGE CHAIR, BLACK STEEL / DARK STAINED OAK / CITY VELVET CA7832/031	949,95	794,92

Additional charge of 10% for CMHR foam in accordance with UK requirement.
Option to upholster with customer's own fabric available upon request. For further information please see our upholstery programme on page 464.

Co Lounge Chair

BY NORM ARCHITECTS & ELS VAN HOOREBEECK

SPEC OPTIONS — PRICES IN EUR *Selected combinations 6–8 weeks delivery time.*

SKU	VARIANT	INCL. VAT	EXCL. VAT
Textile — Seat with upholstery — Powder coated steel base — Black steel — Oak backrest and armrest — Natural oak / Dark stained oak / Black oak			
1195001	PRICE CATEGORY 1 Maple, Kvadrat / Remix 2, Kvadrat / City Velvet, JAB / Hot Madison Reloaded, JAB / Gaja C2C, Gabriel / Champion, Kvadrat	949,95	794,92
1195002	PRICE CATEGORY 2 Hallingdal 65, Kvadrat / Savanna, Kvadrat / Colline, Kvadrat / Canvas, Kvadrat / Ritz, Nevotex / Fiord, Kvadrat / Steelcut 2, Kvadrat / Steelcut Trio 3, Kvadrat / Moss, Kvadrat / Clay, Kvadrat / Divina Melange, Kvadrat	979,95	820,02
1195003	PRICE CATEGORY 3 Vintage, Astrid / Safire, Kvadrat / Satoriale Collection: Grisaille, Dedar / Ponpon, Dedar	999,95	836,76
1195008	PRICE CATEGORY 4 (NEW) Satoriale Collection: Doppioanama, Dedar / Deco, Dedar Texturologie Collection: Lupo, Dedar / Atlas, Dedar	1.429,95	1.196,58
Leather — Seat with upholstery — Powder coated steel base — Black steel — Oak backrest and armrest — Natural oak / Dark Stained oak / Black oak			
1195004	PRICE CATEGORY 1 Ultra, Sørensen Leather / Dakar, Nevotex	999,95	836,76
1195005	PRICE CATEGORY 2 Dunes, Sørensen Leather / Shade, Sørensen Leather / Nuance, Sørensen Leather / Instill, Kvadrat	1.059,95	886,97
1195006	PRICE CATEGORY 3 Royal Nubuck, Sørensen Leather	1.119,95	937,17
1195007	PRICE CATEGORY 4 Elegance, Sørensen Leather	1.179,95	987,38

Additional charge of 10% for CMHR foam in accordance with UK requirement.
Option to upholster with customer's own fabric available upon request. For further information please see our upholstery programme on page 464.

Co Chair Trolley

BY NORM ARCHITECTS & ELS VAN HOOREBEECK

PRODUCT OPTIONS

Black steel trolley with 360-degree swivel casters and foot brake. The Co Chair Trolley makes it easy to transport up to 20 Co Chairs.



STOCK OPTIONS — PRICES IN EUR

Selected combinations up to 2 weeks delivery time.

SKU	VARIANT	INCL. VAT	EXCL. VAT
1175539	CO CHAIR, TROLLEY	699,95	585,72

TECHNICAL SPECIFICATIONS

PRODUCT TYPE Trolley	COLOUR Black (RAL 9005)	CERTIFICATIONS N / A
ENVIRONMENT Indoor	GLOSS Gloss 10-20	PACKAGING TYPE Brown box
DIMENSIONS H: 60 cm / 23,6" W: 72 cm / 28,3" D: 76,5 cm / 76,5"	MATERIALS Powder coated steel	PACKAGING MEASUREMENT (H x W x D) 77 cm x 73 cm x 61,5 cm / 30,3" x 28,7" x 24,2"
PRODUCTION PROCESS N / A	WEIGHT 13,2 kg / 29,1 lb	MATERIALS & MAINTENANCE Please see page 486 for materials and care and maintenance instructions.
	TEST N / A	

Co Chair Row Connection

BY NORM ARCHITECTS & ELS VAN HOOREBEECK

PRODUCT OPTIONS

Row Connection allows you to join individual Co chairs together in a line, making it ideal for use in conference facilities. It is available in two different lengths that correspond to the Co Chair versions with and without armrests. The bracket is easily attached and removed and can be turned to the side when not in use. The Co Chair can be stacked with out without the Row Connection.



STOCK OPTIONS — PRICES IN EUR

Selected combinations up to 2 weeks delivery time.

SKU	VARIANT	INCL. VAT	EXCL. VAT
1160100	ROW CONNECTION FOR CO CHAIR	34,95	29,25
1165100	ROW CONNECTION FOR CO CHAIR W/ARMREST	34,95	29,25

TECHNICAL SPECIFICATIONS

PRODUCT TYPE Connector	PRODUCTION PROCESS Injection moulding	TEST N / A
ENVIRONMENT Indoor	COLOUR Black (RAL 9005)	CERTIFICATIONS N / A
DIMENSIONS Row Connection, Co Chair H: 1,2 cm / 0,5" W: 23 cm / 9,1" L: 7 cm / 2,8"	GLOSS Gloss 20	PACKAGING TYPE Clear poly bag
PRODUCTION PROCESS Row Connection, Co Chair w/Armset H: 1,2 cm / 0,5" W: 28 cm / 11" L: 7 cm / 2,8"	MATERIALS POM plastic	PACKAGING MEASUREMENTS (H x W x D) N / A
	WEIGHT Row Connection, Co Chair: 120 g / 0,3 lb Row Connection, Co Chair w/Armset: 163 g / 0,4 lb	MATERIALS & MAINTENANCE Please see page 486 for materials and care and maintenance instructions.

Afterroom Dining Chair

BY AFTERROOM

Dining chair with tubular powder coated steel base with extended backrest in veneer. Available with or without upholstered seat.



PRODUCT OPTIONS

SEAT



WITHOUT UPHOLSTERY

WITH UPHOLSTERY

POWDER COATED STEEL BASE



BLACK STEEL

SPEC OPTIONS

Available in fabrics from our upholstery programme. Standard lead times apply. Custom upholstery available upon request. For further information please refer to MENU Upholstery Programme.

Afterroom Dining Chair, Black Steel / Black painted Plywood / Dakar 0197, by Afterroom

Afterroom Dining Chair

BY AFTERROOM

TECHNICAL SPECIFICATIONS

PRODUCT TYPE

Dining chair

ENVIRONMENT

Indoor

DIMENSIONS

H: 76,5 cm / 30,1"

SH: 46 cm / 18,1"

W: 45,5 cm / 17,9"

D: 51 cm / 20"

PRODUCTION PROCESS

The base is made from welded, bent steel tubes with a powder coated finish. The seat is milled MDF with a painted finish. The upholstered seat is made with a plywood upholstery shell, foam and upholstery.

COLOUR

Base

Black (RAL 9005)

Seat with upholstery

Dependent upon selected upholstery.

Seat without upholstery

Black (RAL 9005)

GLOSS

Gloss 10-20

MATERIALS

Powder coated steel, painted MDF or plywood, CAL117 foam (50N / 50 kg), upholstery.

WEIGHT

Without upholstery: 4,6 kg / 10,1 lb

With upholstery: 4,2 kg / 9,3 lb

TEST

EN1022:2005, L1

EN16139:2013, L1

CERTIFICATIONS

TSCA title VI compliant

PACKAGING TYPE

Brown box

PACKAGING MEASUREMENTS (H x W x D)

85,5 cm x 45,7 cm x 53,3 cm / 33,7" x 18" x 21"

MATERIALS & MAINTENANCE

Please see page 486 for materials and care and maintenance instructions.

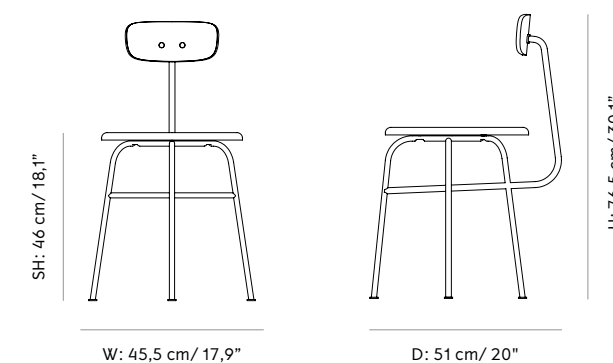

Afterroom Dining Chair

BY AFTEROOM

STOCK OPTIONS — PRICES IN EUR *Selected combinations up to 2 weeks delivery time.*

SKU	VARIANT	INCL. VAT	EXCL. VAT
Seat without upholstery — Powder coated steel base — Black steel			
8420530	 AFTEROOM DINING CHAIR, BLACK STEEL / BLACK	319,95	267,73
Seat with upholstery — Powder coated steel base — Black steel			
8422530	 AFTEROOM DINING CHAIR, BLACK STEEL / DUNES ANTHRACITE 21003	469,95	393,25

QUICK SHIP OPTIONS — PRICES IN EUR *Selected combinations up to 4 weeks delivery time.*

SKU	VARIANT	INCL. VAT	EXCL. VAT
Seat with upholstery — Powder coated steel base — Black steel			
8421530	 AFTEROOM DINING CHAIR, BLACK STEEL / DUNES COGNAC 21000	469,95	393,25

Additional charge of 10% for CMHR foam in accordance with UK requirement.
Option to upholster with customer's own fabric available upon request. For further information please see our upholstery programme on page 464.

Afterroom Dining Chair

BY AFTEROOM

SPEC OPTIONS — PRICES IN EUR *Selected combinations 6–8 weeks delivery time.*

SKU	VARIANT	INCL. VAT	EXCL. VAT
Textile — Seat with upholstery — Powder coated steel base — Black steel			
8420001	PRICE CATEGORY 1 Maple, Kvadrat / Remix 2, Kvadrat / City Velvet, JAB / Hot Madison Reloaded, JAB / Gaja C2C, Gabriel / Champion, Kvadrat	329,95	276,10
8420002	PRICE CATEGORY 2 Hallingdal 65, Kvadrat / Savanna, Kvadrat / Colline, Kvadrat / Canvas, Kvadrat / Ritz, Nevotex / Fiord, Kvadrat / Steelcut 2, Kvadrat / Steelcut Trio 3, Kvadrat / Moss, Kvadrat / Clay, Kvadrat / Divina Melange, Kvadrat	399,95	334,68
8420003	PRICE CATEGORY 3 Vintage, Astrid / Safire, Kvadrat / Satoriale Collection: Grisaille, Dedar / Ponpon, Dedar	469,95	393,25
8420008	PRICE CATEGORY 4 (NEW) Satoriale Collection: Doppiopanama, Dedar / Deco, Dedar Texturologie Collection: Lupo, Dedar / Atlas, Dedar	499,95	418,36
Leather — Seat with upholstery — Powder coated steel base — Black steel			
8420004	PRICE CATEGORY 1 Ultra, Sørensen Leather / Dakar, Nevotex	399,95	334,68
8420005	PRICE CATEGORY 2 Dunes, Sørensen Leather / Shade, Sørensen Leather / Nuance, Sørensen Leather / Instill, Kvadrat	469,95	393,25
8420006	PRICE CATEGORY 3 Royal Nubuck, Sørensen Leather	529,95	443,46
8420007	PRICE CATEGORY 4 Elegance, Sørensen Leather	659,95	552,25

Additional charge of 10% for CMHR foam in accordance with UK requirement.
Option to upholster with customer's own fabric available upon request. For further information please see our upholstery programme on page 464.

Afterroom Dining Chair Plus

BY AFTEROOM

Dining chair with tubular coated steel base with seat in upholstery and extended backrest in upholstery or walnut veneer.



PRODUCT OPTIONS

SEAT

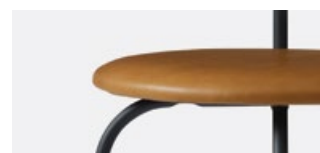

WITH UPHOLSTERY

BACKREST OPTIONS

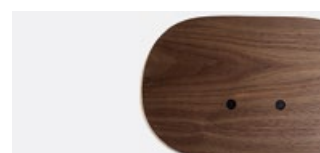

WALNUT

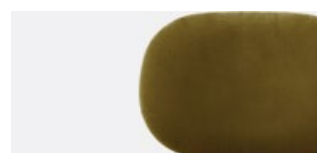

WITH UPHOLSTERY

POWDER COATED STEEL BASE



BLACK STEEL

SPEC OPTIONS



Available in fabrics from our upholstery programme. Standard lead times apply. Custom upholstery available upon request. For further information please refer to MENU Upholstery Programme.

Afterroom Dining Chair Plus, Black Steel /Ritz 4512, by Afterroom

Afterroom Dining Chair Plus

BY AFTEROOM

QUICK SHIP OPTIONS — PRICES IN EUR *Selected combinations up to 4 weeks delivery time.*

SKU	VARIANT	INC. VAT	EX. VAT
Seat and backrest with upholstery — Powder coated steel base — Black steel			
8465979	 AFTEROOM DINING CHAIR PLUS, BLACK STEEL / DAKAR 0250	509,95	426,73
Seat with upholstery — Walnut Backrest — Powder coated steel base — Black steel			
8466569	 AFTEROOM DINING CHAIR PLUS, BLACK STEEL / WALNUT / SHADE 20296	529,95	443,46

TECHNICAL SPECIFICATIONS

PRODUCT TYPE
Dining chair

ENVIRONMENT
Indoor

DIMENSIONS
H: 80 cm / 31,5"
SH: 46 cm / 18,1"
W: 45,5 cm / 17,9"
D: 51 cm / 20"

PRODUCTION PROCESS
The base is made from bent, welded steel tubes with a powder coated finish. The upholstered seat and back are made of plywood upholstery shell, foam and fabric. The walnut back is made of curved walnut veneer.

COLOUR
Base
Black (RAL 9005)

Seat with upholstery
Dependent upon selected upholstery.

Backrest with upholstery
Walnut or dependent upon selected upholstery

GLOSS
Gloss 10-20

MATERIALS
Powder coated steel, walnut veneer, plywood, CAL117 foam (50N / 50 kg), upholstery.

WEIGHT
4,2 kg / 9,3 lb

TEST
EN1022:2005, L1
EN16139:2013, L1

CERTIFICATIONS
TSCA title VI compliant

PACKAGING TYPE
Brown box

PACKAGING MEASUREMENTS (H x W x D)
85,5 cm x 45,7 cm x 53,3 cm / 33,7" x 18" x 21"



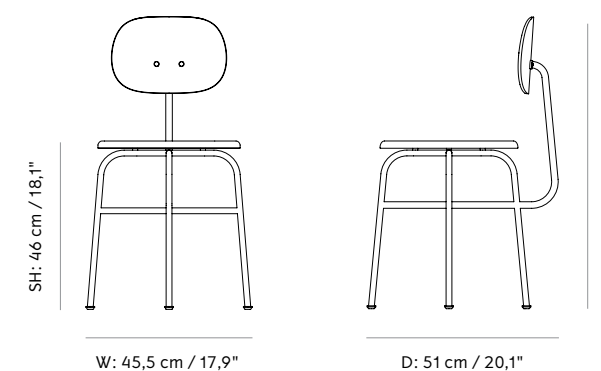

MATERIALS & MAINTENANCE
Please see page 486 for materials and care and maintenance instructions.



Afterroom Dining Chair Plus

BY AFTEROOM

RECOMMENDED COMBINATIONS — PRICES IN EUR *Selected combinations 6–8 weeks delivery time.*

SKU	VARIANT	INCL. VAT	EXCL. VAT
Seat and backrest with upholstery — Powder coated steel base — Black steel			
8465069	 AFTEROOM DINING CHAIR PLUS, BLACK STEEL / MAPLE 222	399,95	334,68
8465469	 AFTEROOM DINING CHAIR PLUS, BLACK STEEL / CITY VELVET CA7832/031	399,95	334,68
8465559	 AFTEROOM DINING CHAIR PLUS, BLACK STEEL / DAKAR 0842	509,95	426,73
400277	 AFTEROOM DINING CHAIR PLUS, BLACK STEEL / DOPPIOPANAMA 001	609,95	510,41

Additional charge of 10% for CMHR foam in accordance with UK requirement.
Option to upholster with customer's own fabric available upon request. For further information please see our upholstery programme on page 464.

Afterroom Dining Chair Plus

BY AFTEROOM

SPEC OPTIONS — PRICES IN EUR *Selected combinations 6–8 weeks delivery time.*

SKU	VARIANT	INCL. VAT	EXCL. VAT
Textile — Seat and backrest with upholstery — Powder coated steel base — Black steel			
8450001	PRICE CATEGORY 1 Maple, Kvadrat / Remix 2, Kvadrat / City Velvet, JAB / Hot Madison Reloaded, JAB / Gaja C2C, Gabriel / Champion, Kvadrat	399,95	334,68
8450002	PRICE CATEGORY 2 Hallingdal 65, Kvadrat / Savanna, Kvadrat / Colline, Kvadrat / Canvas, Kvadrat / Ritz, Nevotex / Fiord, Kvadrat / Steelcut 2, Kvadrat / Steelcut Trio 3, Kvadrat / Moss, Kvadrat / Clay, Kvadrat / Divina Melange, Kvadrat	509,95	426,73
8450003	PRICE CATEGORY 3 Vintage, Astrid / Safire, Kvadrat / Satoriale Collection: Grisaille, Dedar / Ponpon, Dedar	609,95	510,41
8450008	PRICE CATEGORY 4 (NEW) Satoriale Collection: Doppiopanama, Dedar / Deco, Dedar Texturologie Collection: Lupo, Dedar / Atlas, Dedar	669,95	560,61
Leather — Seat and backrest with upholstery — Powder coated steel base — Black steel			
8450004	PRICE CATEGORY 1 Ultra, Sørensen Leather / Dakar, Nevotex	509,95	426,73
8450005	PRICE CATEGORY 2 Dunes, Sørensen Leather / Shade, Sørensen Leather / Nuance, Sørensen Leather / Instill, Kvadrat	609,95	510,41
8450006	PRICE CATEGORY 3 Royal Nubuck, Sørensen Leather	719,95	602,45
8450007	PRICE CATEGORY 4 Elegance, Sørensen Leather	929,95	778,18

Additional charge of 10% for CMHR foam in accordance with UK requirement.
Option to upholster with customer's own fabric available upon request. For further information please see our upholstery programme on page 464.

Afterroom Dining Chair Plus

BY AFTERROOM

SPEC OPTIONS — PRICES IN EUR *Selected combinations 6–8 weeks delivery time.*

SKU	VARIANT	INCL. VAT	EXCL. VAT
Textile — Seat with upholstery — Walnut backrest — Powder coated steel base — Black steel			
8440001	PRICE CATEGORY 1 Maple, Kvadrat / Remix 2, Kvadrat / City Velvet, JAB / Hot Madison Reloaded, JAB / Gaja C2C, Gabriel / Champion, Kvadrat	349,95	292,84
8440002	PRICE CATEGORY 2 Hallingdal 65, Kvadrat / Savanna, Kvadrat / Colline, Kvadrat / Canvas, Kvadrat / Ritz, Nevotex / Fiord, Kvadrat / Steelcut 2, Kvadrat / Steelcut Trio 3, Kvadrat / Moss, Kvadrat / Clay, Kvadrat / Divina Melange, Kvadrat	439,95	368,15
8440003	PRICE CATEGORY 3 Vintage, Astrid / Safire, Kvadrat / Satoriale Collection: Grisaille, Dedar / Ponpon, Dedar	529,95	443,46
8440008	PRICE CATEGORY 4 (NEW) Satoriale Collection: Doppioanama, Dedar / Deco, Dedar Texturologie Collection: Lupo, Dedar / Atlas, Dedar	569,95	476,93
Leather — Seat with upholstery — Walnut backrest — Powder coated steel base — Black steel			
8440004	PRICE CATEGORY 1 Ultra, Sørensen Leather / Dakar, Nevotex	439,95	368,15
8440005	PRICE CATEGORY 2 Dunes, Sørensen Leather / Shade, Sørensen Leather / Nuance, Sørensen Leather / Instill, Kvadrat	529,95	443,46
8440006	PRICE CATEGORY 3 Royal Nubuck, Sørensen Leather	619,95	518,77
8440007	PRICE CATEGORY 4 Elegance, Sørensen Leather	789,95	661,03

Additional charge of 10% for CMHR foam in accordance with UK requirement.
Option to upholster with customer's own fabric available upon request. For further information please see our upholstery programme on page 464.



Afterroom Dining Chair Plus, Black Steel / Walnut/Royal Nubuck Cinnamon 30275, by Afterroom
Afterroom Dining Chair Plus, Black Steel / Royal Nubuck Cinnamon 30275, by Afterroom

Afterroom Dining Chair Plus, Wood Base

BY AFTEROOM

Wood chair in three finishes: natural oak, dark stained oak or black ash. Available with upholstered seat and/or back.

PRODUCT OPTIONS

SEAT

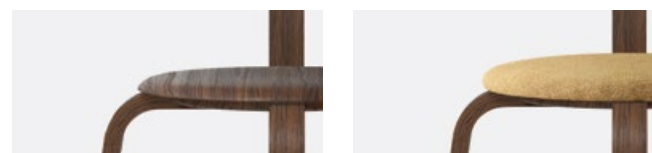

WITHOUT UPHOLSTERY

WITH UPHOLSTERY

BACKREST

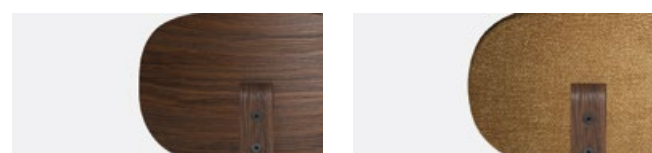

WOOD WITHOUT UPHOLSTERY

WITH UPHOLSTERY

WOOD FINISH

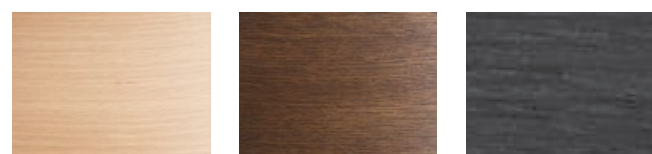

NATURAL OAK

DARK STAINED OAK

BLACK ASH

SPEC OPTIONS

Available in fabrics from our upholstery programme. Standard lead times apply. Custom upholstery available upon request. For further information please refer to MENU Upholstery Programme.

Afterroom Dining Chair Plus, Wood Base, Natural Oak, by Afterroom

Afterroom Dining Chair Plus, Wood Base

BY AFTEROOM

TECHNICAL SPECIFICATIONS

PRODUCT TYPE

Dining chair

ENVIRONMENT

Indoor

DIMENSIONS

H: 80,5 cm / 31,7"

SH: 46,8 cm / 18,4"

W: 57 cm / 22,4"

D: 59 cm / 23,2"

PRODUCTION PROCESS

Seat, back and legs are made from form-pressed plywood. Shell and legs are CNC-milled in a 5-axis CNC machine. Core is birch veneer while outer layers are made from oak veneer.

Painted versions are stained on ash veneer and dark oak.

Upholstered versions feature a layer of foam for extra comfort.

COLOUR

Wood finish

Natural oak
Dark stained oak
Black ash

Seat and backrest without upholstery

Natural oak
Dark stained oak
Black ash

Seat and backrest with upholstery

Dependent upon selected upholstery.

GLOSS

N / A

MATERIALS

Seat, backrest and legs:

Natural oak veneer with matte lacquer, dark stained oak with matte lacquer, black painted ash with matte lacquer and beech core.

Seat with upholstery:

Double foam (CAL117) layer to add extra comfort.

WEIGHT

Without upholstery: 4 kg / 8,8 lb
With upholstery: 4,4kg / 9,7 lb

TEST

N / A

CERTIFICATIONS

TSCA Title VI Compliant

PACKAGING TYPE

Brown box

PACKAGING MEASUREMENTS (H x W x D)

Packaging for one

83,6 cm x 59,7 cm x 57,2 cm / XX

Packaging for two

89,1 cm x 61,7 cm x 57,2 cm / XX

MATERIALS & MAINTENANCE

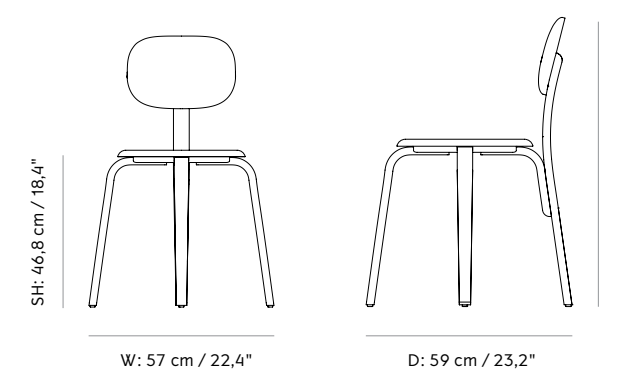

Please see page 486 for materials and care and maintenance instructions.







Afteroom Dining Chair Plus, Wood Base

BY AFTEROOM

STOCK OPTIONS — PRICES IN EUR *Selected combinations up to 2 weeks delivery time.*

SKU	VARIANT	INCL. VAT	EXCL. VAT
Seat and backrest without upholstery — Oak / Ash backrest and base — Natural oak / Dark stained oak / Black ash			
8350039	 AFTEROOM DINING CHAIR PLUS, WOOD BASE, NATURAL OAK (NEW)	449,95	376,52
8350539	 AFTEROOM DINING CHAIR PLUS, WOOD BASE, BLACK ASH (NEW)	449,95	376,52
8350849	 AFTEROOM DINING CHAIR PLUS, WOOD BASE, DARK STAINED OAK (NEW)	449,95	376,52

QUICK SHIP OPTIONS — PRICES IN EUR *Selected combinations up to 4 weeks delivery time.*





SKU	VARIANT	INCL. VAT	EXCL. VAT
Seat and backrest with upholstery — Oak / Ash backrest and base — Natural oak / Dark stained oak / Black ash			
8357550	 AFTEROOM DINING CHAIR PLUS, WOOD BASE, DARK STAINED OAK / DAKAR 0842 (NEW)	689,95	577,35
8357850	 AFTEROOM DINING CHAIR PLUS, WOOD BASE, DARK STAINED OAK / MOSS 022 (NEW)	689,95	577,35
8358150	 AFTEROOM DINING CHAIR PLUS, WOOD BASE, BLACK ASH / MOSS 014 (NEW)	689,95	577,35
8358550	 AFTEROOM DINING CHAIR PLUS, WOOD BASE, BLACK ASH / DAKAR 0842 (NEW)	689,95	577,35
8356970	 AFTEROOM DINING CHAIR PLUS, WOOD BASE, NATURAL OAK / DAKAR 0250	689,95	577,35

Additional charge of 10% for CMHR foam in accordance with UK requirement.
Option to upholster with customer's own fabric available upon request. For further information please see our upholstery programme on page 464.

Afteroom Dining Chair Plus, Wood Base

BY AFTEROOM

QUICK SHIP OPTIONS — PRICES IN EUR *Selected combinations up to 4 weeks delivery time.*

SKU	VARIANT	INCL. VAT	EXCL. VAT
Seat with upholstery — Oak / Ash backrest and base — Dark stained oak / Black ash			
8352550	 AFTEROOM DINING CHAIR PLUS, WOOD BASE, DARK STAINED OAK / DAKAR 0842 (NEW)	639,95	535,51
8352850	 AFTEROOM DINING CHAIR PLUS, WOOD BASE, DARK STAINED OAK / MOSS 022 (NEW)	639,95	535,51
8353150	 AFTEROOM DINING CHAIR PLUS, WOOD BASE, BLACK ASH / MOSS 014 (NEW)	639,95	535,51
8353550	 AFTEROOM DINING CHAIR PLUS, WOOD BASE, BLACK ASH / DAKAR 0842 (NEW)	639,95	535,51

RECOMMENDED COMBINATIONS — PRICES IN EUR *Selected combinations 6–8 weeks delivery time.*

SKU	VARIANT	INCL. VAT	EXCL. VAT
Seat with upholstery — Oak backrest and base — Natural oak			
8350970	 AFTEROOM DINING CHAIR PLUS, WOOD BASE, NATURAL OAK / DAKAR 0250 (NEW)	639,95	535,51

Additional charge of 10% for CMHR foam in accordance with UK requirement.
Option to upholster with customer's own fabric available upon request. For further information please see our upholstery programme on page 464.

Afterroom Dining Chair Plus, Wood Base

BY AFTEROOM



SPEC OPTIONS — PRICES IN EUR *Selected combinations 6–8 weeks delivery time.*

SKU	VARIANT	INCL. VAT	EXCL. VAT
Textile — Seat with upholstery — Ash backrest and base — Black ash			
8350501	PRICE CATEGORY 1 (NEW) Maple, Kvadrat / Remix 2, Kvadrat / City Velvet, JAB / Hot Madison Reloaded, JAB / Gaja C2C, Gabriel / Champion, Kvadrat	549,95	460,20
8350502	PRICE CATEGORY 2 (NEW) Hallingdal 65, Kvadrat / Savanna, Kvadrat / Colline, Kvadrat / Canvas, Kvadrat / Ritz, Nevotex / Fiord, Kvadrat / Steelcut 2, Kvadrat / Steelcut Trio 3, Kvadrat / Moss, Kvadrat / Clay, Kvadrat / Divina Melange, Kvadrat	639,95	535,51
8350503	PRICE CATEGORY 3 (NEW) Vintage, Astrid / Safire, Kvadrat / Satoriale Collection: Grisaille, Dedar / Ponpon, Dedar	749,95	627,56
8350508	PRICE CATEGORY 4 (NEW) Satoriale Collection: DoppioPanama, Dedar / Deco, Dedar Texturologie Collection: Lupo, Dedar / Atlas, Dedar	829,95	694,50
Leather — Seat with upholstery — Ash backrest and base — Black ash			
8350504	PRICE CATEGORY 1 (NEW) Ultra, Sørensen Leather / Dakar, Nevotex	639,95	535,51
8350505	PRICE CATEGORY 2 (NEW) Dunes, Sørensen Leather / Shade, Sørensen Leather / Nuance, Sørensen Leather / Instill, Kvadrat	749,95	627,56
8350506	PRICE CATEGORY 3 (NEW) Royal Nubuck, Sørensen Leather	849,95	711,24
8350507	PRICE CATEGORY 4 (NEW) Elegance, Sørensen Leather	999,95	836,76

Additional charge of 10% for CMHR foam in accordance with UK requirement.
Option to upholster with customer's own fabric available upon request. For further information please see our upholstery programme on page 464.

Afterroom Dining Chair Plus, Wood Base

BY AFTEROOM



SPEC OPTIONS — PRICES IN EUR *Selected combinations 6–8 weeks delivery time.*

SKU	VARIANT	INCL. VAT	EXCL. VAT
Textile — Seat with upholstery — Oak backrest and base — Dark stained oak			
8350801	PRICE CATEGORY 1 (NEW) Maple, Kvadrat / Remix 2, Kvadrat / City Velvet, JAB / Hot Madison Reloaded, JAB / Gaja C2C, Gabriel / Champion, Kvadrat	549,95	460,20
8350802	PRICE CATEGORY 2 Hallingdal 65, Kvadrat / Savanna, Kvadrat / Colline, Kvadrat / Canvas, Kvadrat / Ritz, Nevotex / Fiord, Kvadrat / Steelcut 2, Kvadrat / Steelcut Trio 3, Kvadrat / Moss, Kvadrat / Clay, Kvadrat / Divina Melange, Kvadrat	639,95	535,51
8350803	PRICE CATEGORY 3 (NEW) Vintage, Astrid / Safire, Kvadrat / Satoriale Collection: Grisaille, Dedar / Ponpon, Dedar	749,95	627,56
8350808	PRICE CATEGORY 4 (NEW) Satoriale Collection: DoppioPanama, Dedar / Deco, Dedar Texturologie Collection: Lupo, Dedar / Atlas, Dedar	829,95	694,50
Leather — Seat with upholstery — Oak backrest and base — Dark stained oak			
8350804	PRICE CATEGORY 1 (NEW) Ultra, Sørensen Leather / Dakar, Nevotex	639,95	535,51
8350805	PRICE CATEGORY 2 (NEW) Dunes, Sørensen Leather / Shade, Sørensen Leather / Nuance, Sørensen Leather / Instill, Kvadrat	749,95	627,56
8350806	PRICE CATEGORY 3 (NEW) Royal Nubuck, Sørensen Leather	849,95	711,24
8350807	PRICE CATEGORY 4 (NEW) Elegance, Sørensen Leather	999,95	836,76

Additional charge of 10% for CMHR foam in accordance with UK requirement.
Option to upholster with customer's own fabric available upon request. For further information please see our upholstery programme on page 464.

Afteroom Dining Chair Plus, Wood Base

BY AFTEROOM



SPEC OPTIONS — PRICES IN EUR *Selected combinations 6–8 weeks delivery time.*

SKU	VARIANT	INCL. VAT	EXCL. VAT
Textile — Seat with upholstery — Oak backrest and base — Natural oak			
8350001	PRICE CATEGORY 1 (NEW) Maple, Kvadrat / Remix 2, Kvadrat / City Velvet, JAB / Hot Madison Reloaded, JAB / Gaja C2C, Gabriel / Champion, Kvadrat	549,95	460,20
8350002	PRICE CATEGORY 2 (NEW) Hallingdal 65, Kvadrat / Savanna, Kvadrat / Colline, Kvadrat / Canvas, Kvadrat / Ritz, Nevotex / Flord, Kvadrat / Steelcut 2, Kvadrat / Steelcut Trio 3, Kvadrat / Moss, Kvadrat / Clay, Kvadrat / Divina Melange, Kvadrat	639,95	535,51
8350003	PRICE CATEGORY 3 (NEW) Vintage, Astrid / Safire, Kvadrat / Satoriale Collection: Grisaille, Dedar / Ponpon, Dedar	749,95	627,56
8350008	PRICE CATEGORY 4 (NEW) Satoriale Collection: Doppio Panama, Dedar / Deco, Dedar Texturologie Collection: Lupo, Dedar / Atlas, Dedar	829,95	694,50
Leather — Seat with upholstery — Oak backrest and base — Natural oak			
8350004	PRICE CATEGORY 1 (NEW) Ultra, Sørensen Leather / Dakar, Nevotex	639,95	535,51
8350005	PRICE CATEGORY 2 (NEW) Dunes, Sørensen Leather / Shade, Sørensen Leather / Nuance, Sørensen Leather / Instill, Kvadrat	749,95	627,56
8350006	PRICE CATEGORY 3 (NEW) Royal Nubuck, Sørensen Leather	849,95	711,24
8350007	PRICE CATEGORY 4 (NEW) Elegance, Sørensen Leather	999,95	836,76

Additional charge of 10% for CMHR foam in accordance with UK requirement.
Option to upholster with customer's own fabric available upon request. For further information please see our upholstery programme on page 464.

Afteroom Dining Chair Plus, Wood Base, Black Ash, by Afteroom
Afteroom Dining Chair Plus, Wood Base, Natural Oak, by Afteroom



Afterroom Dining Chair Plus, Wood Base

BY AFTEROOM



SPEC OPTIONS — PRICES IN EUR *Selected combinations 6–8 weeks delivery time.*

SKU	VARIANT	INCL. VAT	EXCL. VAT
Textile — Seat and backrest with upholstery — Ash base — Black ash			
8355501	PRICE CATEGORY 1 (NEW) Maple, Kvadrat / Remix 2, Kvadrat / City Velvet, JAB / Hot Madison Reloaded, JAB / Gaja C2C, Gabriel / Champion, Kvadrat	599,95	502,04
8355502	PRICE CATEGORY 2 (NEW) Hallingdal 65, Kvadrat / Savanna, Kvadrat / Colline, Kvadrat / Canvas, Kvadrat / Ritz, Nevotex / Fiord, Kvadrat / Steelcut 2, Kvadrat / Steelcut Trio 3, Kvadrat / Moss, Kvadrat / Clay, Kvadrat / Divina Melange, Kvadrat	689,95	577,35
8355503	PRICE CATEGORY 3 (NEW) Vintage, Astrid / Safire, Kvadrat / Satoriale Collection: Grisaille, Dedar / Ponpon, Dedar	699,95	585,72
8355508	PRICE CATEGORY 4 (NEW) Satoriale Collection: DoppioPanama, Dedar / Deco, Dedar Texturologie Collection: Lupo, Dedar / Atlas, Dedar	899,95	753,08
Leather — Seat and backrest with upholstery — Ash base — Black ash			
8355504	PRICE CATEGORY 1 (NEW) Ultra, Sørensen Leather / Dakar, Nevotex	689,95	577,35
8355505	PRICE CATEGORY 2 (NEW) Dunes, Sørensen Leather / Shade, Sørensen Leather / Nuance, Sørensen Leather / Instill, Kvadrat	699,95	585,72
8355506	PRICE CATEGORY 3 (NEW) Royal Nubuck, Sørensen Leather	919,95	769,81
8355507	PRICE CATEGORY 4 (NEW) Elegance, Sørensen Leather	1.149,95	962,28

Additional charge of 10% for CMHR foam in accordance with UK requirement.
Option to upholster with customer's own fabric available upon request. For further information please see our upholstery programme on page 464.

Afterroom Dining Chair Plus, Wood Base

BY AFTEROOM



SPEC OPTIONS — PRICES IN EUR *Selected combinations 6–8 weeks delivery time.*

SKU	VARIANT	INCL. VAT	EXCL. VAT
Textile — Seat and backrest with upholstery — Oak base — Dark stained oak			
8355801	PRICE CATEGORY 1 (NEW) Maple, Kvadrat / Remix 2, Kvadrat / City Velvet, JAB / Hot Madison Reloaded, JAB / Gaja C2C, Gabriel / Champion, Kvadrat	599,95	502,04
8355802	PRICE CATEGORY 2 (NEW) Hallingdal 65, Kvadrat / Savanna, Kvadrat / Colline, Kvadrat / Canvas, Kvadrat / Ritz, Nevotex / Fiord, Kvadrat / Steelcut 2, Kvadrat / Steelcut Trio 3, Kvadrat / Moss, Kvadrat / Clay, Kvadrat / Divina Melange, Kvadrat	689,95	577,35
8355803	PRICE CATEGORY 3 (NEW) Vintage, Astrid / Safire, Kvadrat / Satoriale Collection: Grisaille, Dedar / Ponpon, Dedar	699,95	585,72
8355808	PRICE CATEGORY 4 (NEW) Satoriale Collection: DoppioPanama, Dedar / Deco, Dedar Texturologie Collection: Lupo, Dedar / Atlas, Dedar	899,95	753,08
Leather — Seat and backrest with upholstery — Oak base — Dark stained oak			
8355804	PRICE CATEGORY 1 (NEW) Ultra, Sørensen Leather / Dakar, Nevotex	689,95	577,35
8355805	PRICE CATEGORY 2 (NEW) Dunes, Sørensen Leather / Shade, Sørensen Leather / Nuance, Sørensen Leather / Instill, Kvadrat	699,95	585,72
8355806	PRICE CATEGORY 3 (NEW) Royal Nubuck, Sørensen Leather	919,95	769,81
8355807	PRICE CATEGORY 4 (NEW) Elegance, Sørensen Leather	1.149,95	962,28

Additional charge of 10% for CMHR foam in accordance with UK requirement.
Option to upholster with customer's own fabric available upon request. For further information please see our upholstery programme on page 464.

Afteroom Dining Chair Plus, Wood Base

BY AFTEROOM



Afteroom Dining Chair Plus, Wood Base, Dark Stained Oak, by Afteroom

SPEC OPTIONS — PRICES IN EUR *Selected combinations 6–8 weeks delivery time.*

SKU	VARIANT	INCL. VAT	EXCL. VAT
Textile — Seat and backrest with upholstery — Oak base — Natural oak			
8355001	PRICE CATEGORY 1 (NEW) Maple, Kvadrat / Remix 2, Kvadrat / City Velvet, JAB / Hot Madison Reloaded, JAB / Gaja C2C, Gabriel / Champion, Kvadrat	599,95	502,04
8355002	PRICE CATEGORY 2 (NEW) Hallingdal 65, Kvadrat / Savanna, Kvadrat / Colline, Kvadrat / Canvas, Kvadrat / Ritz, Nevotex / Flord, Kvadrat / Steelcut 2, Kvadrat / Steelcut Trio 3, Kvadrat / Moss, Kvadrat / Clay, Kvadrat / Divina Melange, Kvadrat	689,95	577,35
8355003	PRICE CATEGORY 3 (NEW) Vintage, Astrid / Safire, Kvadrat / Satoriale Collection: Grisaille, Dedar / Ponpon, Dedar	699,95	585,72
8355008	PRICE CATEGORY 4 (NEW) Satoriale Collection: Doppiopanama, Dedar / Deco, Dedar Texturologie Collection: Lupo, Dedar / Atlas, Dedar	899,95	753,08
Leather — Seat and backrest with upholstery — Oak base — Natural oak			
8355004	PRICE CATEGORY 1 (NEW) Ultra, Sørensen Leather / Dakar, Nevotex	689,95	577,35
8355005	PRICE CATEGORY 2 (NEW) Dunes, Sørensen Leather / Shade, Sørensen Leather / Nuance, Sørensen Leather / Instill, Kvadrat	699,95	585,72
8355006	PRICE CATEGORY 3 (NEW) Royal Nubuck, Sørensen Leather	919,95	769,81
8355007	PRICE CATEGORY 4 (NEW) Elegance, Sørensen Leather	1.149,95	962,28

Additional charge of 10% for CMHR foam in accordance with UK requirement.
Option to upholster with customer's own fabric available upon request. For further information please see our upholstery programme on page 464.

Afterroom Counter/Bar Chair

BY AFTERROOM

Counter and bar chair with tubular powder coated steel, with extended backrest in veneer. Available with or without upholstered seat.



PRODUCT OPTIONS

SEAT



WITHOUT UPHOLSTERY

WITH UPHOLSTERY

POWDER COATED STEEL BASE



BLACK STEEL

SPEC OPTIONS

Available in fabrics from our upholstery programme. Standard lead times apply. Custom upholstery available upon request. For further information please refer to MENU Upholstery Programme.



Afterroom Bar Chairs, Black Steel / Dunes Leather 21003, by Afterroom

Afterroom Counter/Bar Chair

BY AFTERROOM

TECHNICAL SPECIFICATIONS

PRODUCT TYPE

Counter and bar chair

ENVIRONMENT

Indoor

DIMENSIONS

Counter

H: 92 cm / 36,2"
SH: 63,5 cm / 25"
W: 48 cm / 18,9"
D: 54 cm / 21,3"

Bar

H: 102 cm / 40,2"
SH: 73,5 cm / 28,9"
W: 50 cm / 19,7"
D: 55 cm / 21,7"

PRODUCTION PROCESS

The base is made of bent, welded steel tubes with a powder coated finish. The seat is milled MDF with a painted finish. The upholstered seat is made of plywood upholstery shell, foam and fabric.

COLOUR

Base
Black (RAL 9005)

Seat with upholstery
Dependent upon selected upholstery.

Backrest and Seat without upholsteryprogram
Black (RAL 9005)

GLOSS

Gloss 10-20

MATERIALS

Powder coated steel and painted MDF or plywood, CAL117 foam (50N/50 kg) and upholstery.

WEIGHT

Counter without upholstery: 5,5 kg / 12,1 lb
Counter with upholstery: 5 kg / 11 lb
Bar without upholstery: 5,8 kg / 12,8 lb
Bar with upholstery: 5,5 kg / 12,1 lb

TEST

EN1022:2005, L2
EN16139:2013, L2

CERTIFICATIONS

TSCA title VI compliant

PACKAGING TYPE

Brown box

PACKAGING MEASUREMENTS (H x W x D)

Counter

110 cm x 48 cm x 48 cm / 43,3" x 18,9" x 18,9"

Bar

110 cm x 48 cm x 48 cm / 43,3" x 18,9" x 18,9"

MATERIALS & MAINTENANCE

Please see page 486 for materials and care and maintenance instructions.

AFTERROOM COUNTER CHAIR

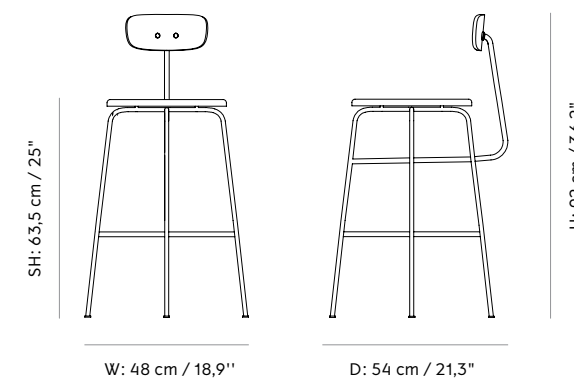

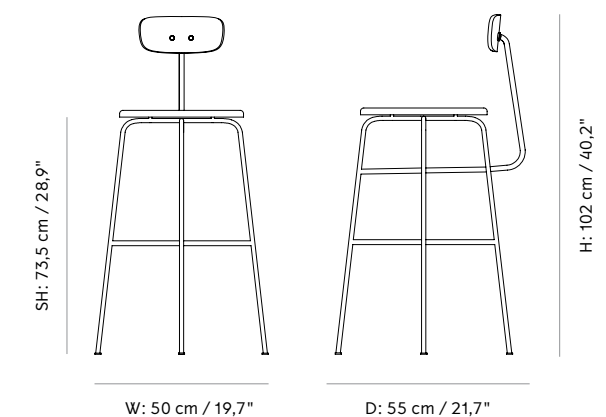

AFTERROOM BAR CHAIR



Afterroom Counter Chair

BY AFTEROOM

STOCK OPTIONS — PRICES IN EUR *Selected combinations up to 2 weeks delivery time.*

SKU	VARIANT	INCL. VAT	EXCL. VAT
Seat without upholstery — Powder coated steel base — Black steel			
9410530	 AFTEROOM COUNTER CHAIR, BLACK STEEL / BLACK	369,95	309,57
Seat with Upholstery — Powder coated steel Base — Black Steel			
9422530	 AFTEROOM COUNTER CHAIR, BLACK STEEL / DUNES ANTHRAZITE 21003	579,95	485,30

QUICK SHIP OPTIONS — PRICES IN EUR *Selected combinations up to 4 weeks delivery time.*

SKU	VARIANT	INCL. VAT	EXCL. VAT
Seat with upholstery — Powder coated steel base — Black steel			
9421530	 AFTEROOM COUNTER CHAIR, BLACK STEEL / DUNES COGNAC 21000	579,95	485,30

Additional charge of 10% for CMHR foam in accordance with UK requirement.
Option to upholster with customer's own fabric available upon request. For further information please see our upholstery programme on page 464.

Afterroom Counter Chair

BY AFTEROOM

SPEC OPTIONS — PRICES IN EUR *Selected combinations 6–8 weeks delivery time.*

SKU	VARIANT	INCL. VAT	EXCL. VAT
Textile — Seat with upholstery — Powder coated steel base — Black steel			
9410001	PRICE CATEGORY 1 Maple, Kvadrat / Remix 2, Kvadrat / City Velvet, JAB / Hot Madison Reloaded, JAB / Gaja C2C, Gabriel / Champion, Kvadrat	389,95	326,31
9410002	PRICE CATEGORY 2 Hallingdal 65, Kvadrat / Savanna, Kvadrat / Colline, Kvadrat / Canvas, Kvadrat / Ritz, Nevotex / Fiord, Kvadrat / Steelcut 2, Kvadrat / Steelcut Trio 3, Kvadrat / Moss, Kvadrat / Clay, Kvadrat / Divina Melange, Kvadrat	469,95	393,25
9410003	PRICE CATEGORY 3 Vintage, Astrid / Safire, Kvadrat / Satoriale Collection: Grisaille, Dedar / Ponpon, Dedar	549,95	460,20
9410008	PRICE CATEGORY 4 (NEW) Satoriale Collection: Doppiopanama, Dedar / Deco, Dedar Texturologie Collection: Lupo, Dedar / Atlas, Dedar	589,95	493,67
Leather — Seat with upholstery — Powder coated steel base — Black steel			
9410004	PRICE CATEGORY 1 Ultra, Sørensen Leather / Dakar, Nevotex	469,95	393,25
9410005	PRICE CATEGORY 2 Dunes, Sørensen Leather / Shade, Sørensen Leather / Nuance, Sørensen Leather / Instill, Kvadrat	549,95	460,20
9410006	PRICE CATEGORY 3 Royal Nubuck, Sørensen Leather	629,95	527,14
9410007	PRICE CATEGORY 4 Elegance, Sørensen Leather	779,95	652,66

Additional charge of 10% for CMHR foam in accordance with UK requirement.
Option to upholster with customer's own fabric available upon request. For further information please see our upholstery programme on page 464.



Afterroom Bar Chair

BY AFTEROOM

STOCK OPTIONS — PRICES IN EUR *Selected combinations up to 2 weeks delivery time.*

SKU	VARIANT	INCL. VAT	EXCL. VAT
Seat without upholstery — Powder coated steel base — Black steel			
9400530	 AFTEROOM BAR CHAIR, BLACK STEEL / BLACK	369,95	309,57

QUICK SHIP OPTIONS — PRICES IN EUR *Selected combinations up to 4 weeks delivery time.*

SKU	VARIANT	INCL. VAT	EXCL. VAT
Seat with upholstery — Powder coated steel base — Black steel			
9417530	 AFTEROOM BAR CHAIR, BLACK STEEL / DUNES ANTHRAZITE 21003	579,95	485,30
9416530	 AFTEROOM BAR CHAIR, BLACK STEEL / DUNES COGNAC 21000	579,95	485,30

Additional charge of 10% for CMHR foam in accordance with UK requirement.
Option to upholster with customer's own fabric available upon request. For further information please see our upholstery programme on page 464.

Afterroom Bar Chair

BY AFTEROOM

SPEC OPTIONS — PRICES IN EUR *Selected combinations 6–8 weeks delivery time.*

SKU	VARIANT	INCL. VAT	EXCL. VAT
Textile — Seat with upholstery — Powder coated steel base — Black steel			
9400001	PRICE CATEGORY 1 Maple, Kvadrat / Remix 2, Kvadrat / City Velvet, JAB / Hot Madison Reloaded, JAB / Gaja C2C, Gabriel / Champion, Kvadrat	389,95	326,31
9400002	PRICE CATEGORY 2 Hallingdal 65, Kvadrat / Savanna, Kvadrat / Colline, Kvadrat / Canvas, Kvadrat / Ritz, Nevotex / Fiord, Kvadrat / Steelcut 2, Kvadrat / Steelcut Trio 3, Kvadrat / Moss, Kvadrat / Clay, Kvadrat / Divina Melange, Kvadrat	469,95	393,25
9400003	PRICE CATEGORY 3 Vintage, Astrid / Safire, Kvadrat / Satoriale Collection: Grisaille, Dedar / Ponpon, Dedar	549,95	460,20
9400008	PRICE CATEGORY 4 (NEW) Satoriale Collection: Doppiopanama, Dedar / Deco, Dedar Texturologie Collection: Lupo, Dedar / Atlas, Dedar	589,95	493,67
Leather — Seat with upholstery — Powder coated steel base — Black steel			
9400004	PRICE CATEGORY 1 Ultra, Sørensen Leather / Dakar, Nevotex	469,95	393,25
9400005	PRICE CATEGORY 2 Dunes, Sørensen Leather / Shade, Sørensen Leather / Nuance, Sørensen Leather / Instill, Kvadrat	549,95	460,20
9400006	PRICE CATEGORY 3 Royal Nubuck, Sørensen Leather	629,95	527,14
9400007	PRICE CATEGORY 4 Elegance, Sørensen Leather	779,95	652,66

Additional charge of 10% for CMHR foam in accordance with UK requirement.
Option to upholster with customer's own fabric available upon request. For further information please see our upholstery programme on page 464.

Afterroom Counter/Bar Chair Plus

BY AFTEROOM

Counter and bar chair with tubular powder coated steel, with a circular footring. Seat in upholstery and extended backrest in upholstery or walnut veneer.



PRODUCT OPTIONS

SEAT



WITH UPHOLSTERY

BACKREST OPTIONS

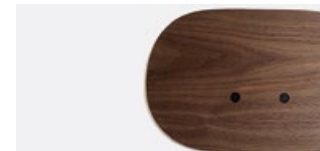

WALNUT

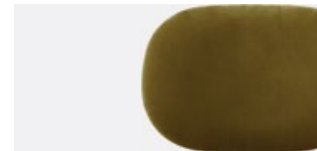

WITH UPHOLSTERY

POWDER COATED STEEL BASE



BLACK STEEL

SPEC OPTIONS

Available in fabrics from our upholstery programme. Standard lead times apply. Custom upholstery available upon request. For further information please refer to MENU Upholstery Programme.

Afterroom Counter Chair Plus, Black Steel / Gaja C2C 61115, by Afterroom
 Afterroom Bar Chair Plus, Black Steel / Ritz Brun 8469, by Afterroom
 Snaregade Counter Table, Light Grey Oak / Light Grey Oak, by Norm Architects
 Snaregade Bar Table, Black Steel / Black Oak, by Norm Architects

Afterroom Counter/Bar Chair Plus

BY AFTEROOM

TECHNICAL SPECIFICATIONS

PRODUCT TYPE

Counter and bar chair

ENVIRONMENT

Indoor

DIMENSIONS

Counter

H: 92 cm / 36,2"
 SH: 63,5 cm / 25"
 W: 46 cm / 18,1"
 D: 54 cm / 21,2"

Bar

H: 102 cm / 40,2"
 SH: 73,5 cm / 28,9"
 W: 50 cm / 19,7"
 D: 55 cm / 21,2"

PRODUCTION PROCESS

The base is made of bended and welded steel tubes. The base has a powder coated finish. The seat is milled MDF with a painted finish. The upholstered seat is made on plywood upholstery shell, foam and upholstery. The walnut backrest is made of curved walnut veneer.

COLOUR

Base
 Black RAL (RAL 9005)

Seat and backrest with upholstery
 Dependent upon selected upholstery.

Backrest
 Walnut or dependent upon selected upholstery.

GLOSS
 Gloss 10-20

MATERIALS

Powder coated steel, walnut veneer, plywood, CAL117 foam (50N / 50kg), upholstery.

WEIGHT

Counter: 5 kg / 11 lb
 Bar: 5,4 kg / 11,9 lb

TEST

EN1022:2005, L2
 EN16139:2013, L2

CERTIFICATIONS
 TSCA title VI compliant

PACKAGING TYPE
 Brown box

PACKAGING MEASUREMENTS (H x W x D)

Counter
 110 cm x 48 cm x 48 cm / 43,3" x 18,9" x 18,9"

Bar
 110 cm x 48 cm x 48 cm / 43,3" x 18,9" x 18,9"

MATERIALS & MAINTENANCE
 Please see page 486 for materials and care and maintenance instructions.

AFTEROOM COUNTER CHAIR PLUS

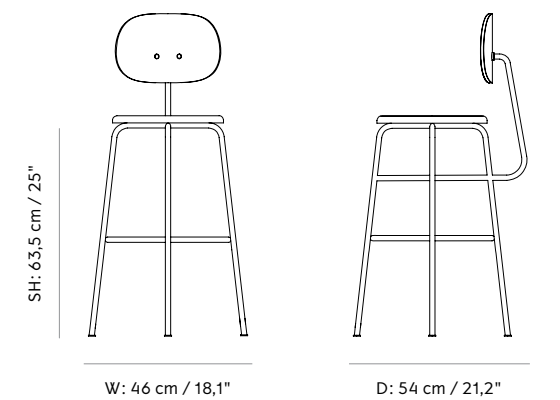

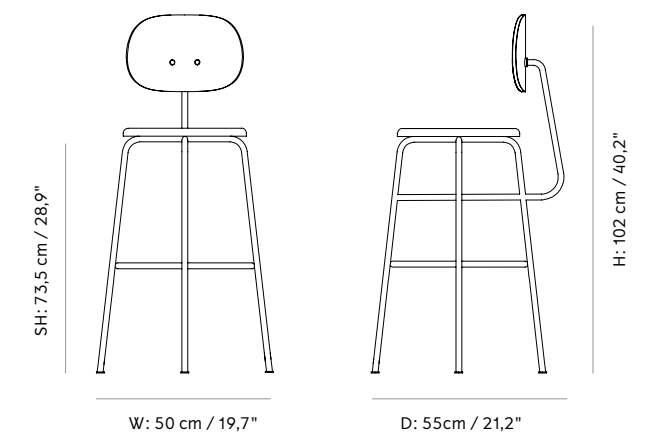

AFTEROOM BAR CHAIR PLUS





Afteroom Counter Chair Plus

BY AFTERROOM

QUICK SHIP OPTIONS — PRICES IN EUR *Selected combinations up to 4 weeks delivery time.*

SKU	VARIANT	INCL. VAT	EXCL. VAT
Seat and backrest with upholstery — Powder coated steel base — Black steel			
9425469	 AFTERROOM COUNTER CHAIR PLUS, BLACK STEEL / CITY VELVET CA7832/031	529,95	443,46
9425979	 AFTERROOM COUNTER CHAIR PLUS, BLACK STEEL / DAKAR 0250	639,95	535,51

RECOMMENDED COMBINATIONS — PRICES IN EUR *Selected combinations 6–8 weeks delivery time.*

SKU	VARIANT	INCL. VAT	EXCL. VAT
Seat and backrest with upholstery — Powder coated steel base — Black steel			
9425069	 AFTERROOM COUNTER CHAIR PLUS, BLACK STEEL / MAPLE 222	529,95	443,46
9425559	 AFTERROOM COUNTER CHAIR PLUS, BLACK STEEL / DAKAR 0842	639,95	535,51
9425129	 AFTERROOM COUNTER CHAIR PLUS, BLACK STEEL / DAKAR 0854	639,95	535,51

Additional charge of 10% for CMHR foam in accordance with UK requirement.
Option to upholster with customer's own fabric available upon request. For further information please see our upholstery programme on page 464.

Afteroom Counter Chair Plus, Black Steel / Gaja C2C 61115, by Afteroom
Snaregade Counter Table, Light Grey Oak / Light Grey Oak, by Norm Architects



Afterroom Counter Chair Plus

BY AFTEROOM

SPEC OPTIONS — PRICES IN EUR *Selected combinations 6–8 weeks deliveru time.*

SKU	VARIANT	INCL. VAT	EXCL. VAT
Textile — Seat with upholstery — Walnut backrest — Powder coated steel base — Black steel			
9445001	PRICE CATEGORY 1 Maple, Kvadrat / Remix 2, Kvadrat / City Velvet, JAB / Hot Madison Reloaded, JAB / Gaja C2C, Gabriel / Champion, Kvadrat	439,95	368,15
9445002	PRICE CATEGORY 2 Hallingdal 65, Kvadrat / Savanna, Kvadrat / Colline, Kvadrat / Canvas, Kvadrat / Ritz, Nevotex / Fiord, Kvadrat / Steelcut 2, Kvadrat / Steelcut Trio 3, Kvadrat / Moss, Kvadrat / Clay, Kvadrat / Divina Melange, Kvadrat	529,95	443,46
9445003	PRICE CATEGORY 3 Vintage, Astrid / Safire, Kvadrat / Satoriale Collection: Grisaille, Dedar / Ponpon, Dedar	619,95	518,77
9445008	PRICE CATEGORY 4 (NEW) Satoriale Collection: Doppioanama, Dedar / Deco, Dedar Texturologie Collection: Lupo, Dedar / Atlas, Dedar	659,95	552,25
Textile — Seat with upholstery — Walnut backrest — Powder coated steel base — Black steel			
9445004	PRICE CATEGORY 1 Ultra, Sørensen Leather / Dakar, Nevotex	529,95	443,46
9445005	PRICE CATEGORY 2 Dunes, Sørensen Leather / Shade, Sørensen Leather / Nuance, Sørensen Leather / Instill, Kvadrat	619,95	518,77
9445006	PRICE CATEGORY 3 Royal Nubuck, Sørensen Leather	709,95	594,09
9445007	PRICE CATEGORY 4 Elegance, Sørensen Leather	879,95	736,34

Additional charge of 10% for CMHR foam in accordance with UK requirement.
Option to upholster with customer's own fabric available upon request. For further information please see our upholstery programme on page 464.

Afterroom Counter Chair Plus

BY AFTEROOM

SPEC OPTIONS — PRICES IN EUR *Selected combinations 6–8 weeks deliveru time.*



SKU	VARIANT	INCL. VAT	EXCL. VAT
Textile — Seat and backrest with upholstery — Powder coated steel base — Black steel			
9455001	PRICE CATEGORY 1 Maple, Kvadrat / Remix 2, Kvadrat / City Velvet, JAB / Hot Madison Reloaded, JAB / Gaja C2C, Gabriel / Champion, Kvadrat	529,95	443,46
9455002	PRICE CATEGORY 2 Hallingdal 65, Kvadrat / Savanna, Kvadrat / Colline, Kvadrat / Canvas, Kvadrat / Ritz, Nevotex / Fiord, Kvadrat / Steelcut 2, Kvadrat / Steelcut Trio 3, Kvadrat / Moss, Kvadrat / Clay, Kvadrat / Divina Melange, Kvadrat	639,95	535,51
9455003	PRICE CATEGORY 3 Vintage, Astrid / Safire, Kvadrat / Satoriale Collection: Grisaille, Dedar / Ponpon, Dedar	739,95	619,19
9455008	PRICE CATEGORY 4 (NEW) Satoriale Collection: Doppioanama, Dedar / Deco, Dedar Texturologie Collection: Lupo, Dedar / Atlas, Dedar	799,95	669,40
Leather — Seat and backrest with upholstery — Powder coated steel base — Black steel			
9455004	PRICE CATEGORY 1 Ultra, Sørensen Leather / Dakar, Nevotex	639,95	535,51
9455005	PRICE CATEGORY 2 Dunes, Sørensen Leather / Shade, Sørensen Leather / Nuance, Sørensen Leather / Instill, Kvadrat	739,95	619,19
9455006	PRICE CATEGORY 3 Royal Nubuck, Sørensen Leather	849,95	711,24
9455007	PRICE CATEGORY 4 Elegance, Sørensen Leather	1.059,95	886,97

Additional charge of 10% for CMHR foam in accordance with UK requirement.
Option to upholster with customer's own fabric available upon request. For further information please see our upholstery programme on page 464.



Afterroom Bar Chair Plus

BY AFTEROOM

QUICK SHIP OPTIONS — PRICES IN EUR *Selected combinations up to 4 weeks delivery time.*

SKU	VARIANT	INCL. VAT	EXCL. VAT
Seat and backrest with upholstery — Powder coated steel base — Black steel			
9435469	 AFTEROOM BAR CHAIR PLUS, BLACK STEEL / CITY VELVET CA7832/031	529,95	443,46
9435979	 AFTEROOM BAR CHAIR PLUS, BLACK STEEL / DAKAR 0250	639,95	535,51

RECOMMENDED COMBINATIONS — PRICES IN EUR *Selected combinations 6–8 weeks delivery time.*

SKU	VARIANT	INCL. VAT	EXCL. VAT
Seat and backrest with upholstery — Powder coated steel base — Black steel			
9435069	 AFTEROOM BAR CHAIR PLUS, BLACK STEEL / MAPLE 222	529,95	443,46
9435129	 AFTEROOM BAR CHAIR PLUS, BLACK STEEL / DAKAR 0854	639,95	535,51
9435559	 AFTEROOM BAR CHAIR PLUS, BLACK STEEL / DAKAR 0842	639,95	535,51

Additional charge of 10% for CMHR foam in accordance with UK requirement.
Option to upholster with customer's own fabric available upon request. For further information please see our upholstery programme on page 464.

Afterroom Bar Chair Plus, Black Steel / City Velvet CA7832/031, by Afterroom
Marble Wall Clock, Nero Marquina Marble, by Norm Architects



Afterroom Bar Chair Plus

BY AFTEROOM

SPEC OPTIONS — PRICES IN EUR *Selected combinations 6–8 weeks delivery time.*

SKU	VARIANT	INCL. VAT	EXCL. VAT
Textile — Seat with upholstery — Walnut backrest — Powder coated steel base — Black steel			
9440001	PRICE CATEGORY 1 Maple, Kvadrat / Remix 2, Kvadrat / City Velvet, JAB / Hot Madison Reloaded, JAB / Gaja C2C, Gabriel / Champion, Kvadrat	439,95	368,15
9440002	PRICE CATEGORY 2 Hallingdal 65, Kvadrat / Savanna, Kvadrat / Colline, Kvadrat / Canvas, Kvadrat / Ritz, Nevotex / Fiord, Kvadrat / Steelcut 2, Kvadrat / Steelcut Trio 3, Kvadrat / Moss, Kvadrat / Clay, Kvadrat / Divina Melange, Kvadrat	529,95	443,46
9440003	PRICE CATEGORY 3 Vintage, Astrid / Safire, Kvadrat / Satoriale Collection: Grisaille, Dedar / Ponpon, Dedar	619,95	518,77
9440008	PRICE CATEGORY 4 (NEW) Satoriale Collection: Doppioanama, Dedar / Deco, Dedar Texturologie Collection: Lupo, Dedar / Atlas, Dedar	659,95	552,25
Leather — Seat with upholstery — Walnut backrest — Powder coated steel base — Black steel			
9440004	PRICE CATEGORY 1 Ultra, Sørensen Leather / Dakar, Nevotex	529,95	443,46
9440005	PRICE CATEGORY 2 Dunes, Sørensen Leather / Shade, Sørensen Leather / Nuance, Sørensen Leather / Instill, Kvadrat	619,95	518,77
9440006	PRICE CATEGORY 3 Royal Nubuck, Sørensen Leather	709,95	594,09
9440007	PRICE CATEGORY 4 Elegance, Sørensen Leather	879,95	736,34

Additional charge of 10% for CMHR foam in accordance with UK requirement.
Option to upholster with customer's own fabric available upon request. For further information please see our upholstery programme on page 464.

Afterroom Bar Chair Plus

BY AFTEROOM

SPEC OPTIONS — PRICES IN EUR *Selected combinations 6–8 weeks delivery time.*

SKU	VARIANT	INCL. VAT	EXCL. VAT
Textile — Seat and backrest with upholstery — Powder coated steel base — Black steel			
9450001	PRICE CATEGORY 1 Maple, Kvadrat / Remix 2, Kvadrat / City Velvet, JAB / Hot Madison Reloaded, JAB / Gaja C2C, Gabriel / Champion, Kvadrat	529,95	443,46
9450002	PRICE CATEGORY 2 Hallingdal 65, Kvadrat / Savanna, Kvadrat / Colline, Kvadrat / Canvas, Kvadrat / Ritz, Nevotex / Fiord, Kvadrat / Steelcut 2, Kvadrat / Steelcut Trio 3, Kvadrat / Moss, Kvadrat / Clay, Kvadrat / Divina Melange, Kvadrat	639,95	535,51
9450003	PRICE CATEGORY 3 Vintage, Astrid / Safire, Kvadrat / Satoriale Collection: Grisaille, Dedar / Ponpon, Dedar	739,95	619,19
9450008	PRICE CATEGORY 4 (NEW) Satoriale Collection: Doppioanama, Dedar / Deco, Dedar Texturologie Collection: Lupo, Dedar / Atlas, Dedar	799,95	669,40
Leather — Seat and backrest with upholstery — Powder coated steel base — Black steel			
9450004	PRICE CATEGORY 1 Ultra, Sørensen Leather / Dakar, Nevotex	639,95	535,51
9450005	PRICE CATEGORY 2 Dunes, Sørensen Leather / Shade, Sørensen Leather / Nuance, Sørensen Leather / Instill, Kvadrat	739,95	619,19
9450006	PRICE CATEGORY 3 Royal Nubuck, Sørensen Leather	849,95	711,24
9450007	PRICE CATEGORY 4 Elegance, Sørensen Leather	1.059,95	886,97

Additional charge of 10% for CMHR foam in accordance with UK requirement.
Option to upholster with customer's own fabric available upon request. For further information please see our upholstery programme on page 464.

Afterroom Stool

BY AFTEROOM

Stool with tubular powder coated steel, with a circular footring. Available with or without upholstered seat.



PRODUCT OPTIONS

SEAT



WITHOUT UPHOLSTERY



WITH UPHOLSTERY

POWDER COATED STEEL BASE



BLACK STEEL

SPEC OPTIONS

Available in fabrics from our upholstery programme. Standard lead times apply. Custom upholstery available upon request. For further information please refer to MENU Upholstery Programme.

Afterroom Stool, Black Steel / Dakar Leather, by Afterroom
Afterroom Counter Stool, Black Steel / Colline 118, by Afterroom

Afterroom Stool

BY AFTEROOM

STOCK OPTIONS — PRICES IN EUR *Selected combinations up to 2 weeks delivery time.*

SKU	VARIANT	INCL. VAT	EXCL. VAT
Seat without Upholstery — Powder coated steel Base — Black Steel			
8480530	AFTEROOM STOOL, BLACK STEEL / BLACK	139,95	117,11

TECHNICAL SPECIFICATIONS

PRODUCT TYPE
Stool

ENVIRONMENT
Indoor

DIMENSIONS
SH: 47 cm / 18,5"
W: 45,4 cm / 17,9"
D: 45,4 cm / 17,9"

PRODUCTION PROCESS
The base is made of bent, welded steel tubes with a powder coated finish. The seat is milled MDF with a painted finish. The upholstered seat is made of plywood upholstery shell, foam and fabric.

COLOUR
Base
Black (RAL 9005)

Seat with upholstery
Dependent upon selected upholstery.

Seat without upholstery
Black (RAL 9005)

GLOSS
Gloss 10-20

MATERIALS
Powder coated steel, painted MDF, CAL117, upholstery.

WEIGHT
Without upholstery: 3,5 kg / 7,7 lb
With upholstery: 2,9 kg / 6,4 lb

TEST
N / A

CERTIFICATIONS
TSCA title VI compliant

PACKAGING TYPE
Brown box

PACKAGING MEASUREMENTS (H x W x D)
49 cm x 40 cm x 40 cm / 19,3" x 15,7" x 15,7"

MATERIALS & MAINTENANCE
Please see page 486 for materials and care and maintenance instructions.

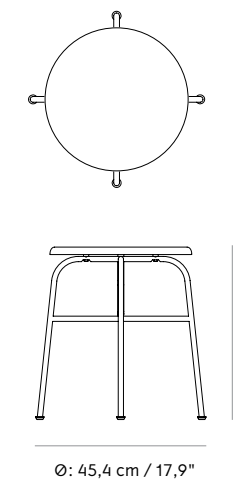

Ø: 45,4 cm / 17,9"

SH: 47 cm / 18,5"

Afterroom Stool

BY AFTERROOM

Afterroom Stool, Black Steel / Dakar Leather, by Afterroom
 Afterroom Counter Stool, Black Steel / Colline 118, by Afterroom
 Afterroom Bar Stool, Black Steel / Gaja C2C, by Afterroom

SPEC OPTIONS — PRICES IN EUR *Selected combinations 6–8 weeks delivery time.*

SKU	VARIANT	INCL. VAT	EXCL. VAT
Textile — Seat with upholstery — Powder coated steel base — Black steel			
8480001	PRICE CATEGORY 1 Maple, Kvadrat / Remix 2, Kvadrat / City Velvet, JAB / Hot Madison Reloaded, JAB / Gaja C2C, Gabriel / Champion, Kvadrat	199,95	167,32
8480002	PRICE CATEGORY 2 Hallingdal 65, Kvadrat / Savanna, Kvadrat / Colline, Kvadrat / Canvas, Kvadrat / Ritz, Nevotex / Fiord, Kvadrat / Steelcut 2, Kvadrat / Steelcut Trio 3, Kvadrat / Moss, Kvadrat / Clay, Kvadrat / Divina Melange, Kvadrat	259,95	217,53
8480003	PRICE CATEGORY 3 Vintage, Astrid / Safire, Kvadrat / Satoriale Collection: Grisaille, Dedar / Ponpon, Dedar	309,95	259,37
8480008	PRICE CATEGORY 4 (NEW) Satoriale Collection: Doppio Panama, Dedar / Deco, Dedar Texturologie Collection: Lupo, Dedar / Atlas, Dedar	339,95	284,47
Leather — Seat with upholstery — Powder coated steel base — Black steel			
8480004	PRICE CATEGORY 1 Ultra, Sørensen Leather / Dakar, Nevotex	259,95	217,53
8480005	PRICE CATEGORY 2 Dunes, Sørensen Leather / Shade, Sørensen Leather / Nuance, Sørensen Leather / Instill, Kvadrat	309,95	259,37
8480006	PRICE CATEGORY 3 Royal Nubuck, Sørensen Leather	369,95	309,57
8480007	PRICE CATEGORY 4 Elegance, Sørensen Leather	469,95	393,25

Additional charge of 10% for CMHR foam in accordance with UK requirement.
 Option to upholster with customer's own fabric available upon request. For further information please see our upholstery programme on page 464.



Afterroom Counter/Bar Stool

BY AFTEROOM

Counter and bar stool with tubular powder coated steel, with a circular footring. Available with or without upholstered seat.



PRODUCT OPTIONS

SEAT



WITHOUT UPHOLSTERY

WITH UPHOLSTERY

POWDER COATED STEEL BASE



BLACK STEEL

SPEC OPTIONS



Available in fabrics from our upholstery programme. Standard lead times apply. Custom upholstery available upon request. For further information please refer to MENU Upholstery Programme.

Afterroom Stool, Black Steel / Dakar Leather, by Afterroom
 Afterroom Counter Stool, Black Steel / Colline 118, by Afterroom
 Afterroom Bar Stool, Black Steel / Gaja C2C, by Afterroom

Afterroom Counter/Bar Stool

BY AFTEROOM

STOCK OPTIONS — PRICES IN EUR *Selected combinations up to 2 weeks delivery time.*

SKU	VARIANT	INCL. VAT	EXCL. VAT
Seat without Upholstery — Powder coated steel Base — Black Steel			
9480530	 AFTEROOM COUNTER STOOL, BLACK STEEL / BLACK	199,95	167,32
9470530	 AFTEROOM BAR STOOL, BLACK STEEL / BLACK	199,95	167,32

TECHNICAL SPECIFICATIONS

PRODUCT TYPE
Counter and bar stool

ENVIRONMENT
Indoor

DIMENSIONS

Counter
 H: 92 cm / 36,2"
 SH: 63,5 cm / 25"
 Ø: 48 cm / 18,9"

Bar
 H: 102 cm / 40,2"
 SH: 73,5 cm / 28,9"
 Ø: 50 cm / 19,7"

PRODUCTION PROCESS
 The base is made of bended and welded steel tubes. The base has a powder coated finish. The seat is milled MDF with a painted finish. The upholstered seat is made on plywood upholstery shell, foam and upholstery.

COLOUR
Base
 Black (RAL 9005)

Seat with upholstery
 Dependent upon selected upholstery.

Seat without Upholstery
 Black

GLOSS
 Gloss 10-20

MATERIALS
 Powder coated steel, painted MDF, CAL117 foam, upholstery.

WEIGHT
 Counter, without upholstery: 4,2 kg / 9,3 lb
 Counter, with upholstery: 3,6 kg / 8 lb

Bar, without upholstery: 4,5 kg / 10 lb
 Bar, with upholstery: 3,8 kg / 8,4 lb

TEST
 N / A

CERTIFICATIONS
 TSCA title VI compliant

PACKAGING TYPE
 Brown box

PACKAGING MEASUREMENTS (H x W x D)

Counter
 75,5 cm x 43,3 cm x 43,3 cm / 29,7" x 17" x 17"

Bar
 75,5 cm x 43,3 cm x 43,3 cm / 29,7" x 17" x 17"

MATERIALS & MAINTENANCE
 Please see page 486 for materials and care and maintenance instructions.

AFTEROOM COUNTER STOOL

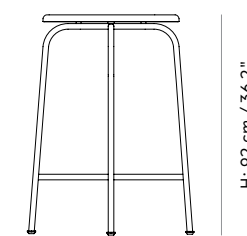

Ø: 48 cm / 18,9"

H: 92 cm / 36,2"

AFTEROOM BAR STOOL

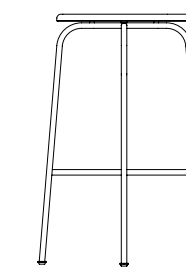

Ø: 50 cm / 19,7"

H: 102 cm / 40,2"

Afterroom Counter Stool

BY AFTEROOM

SPEC OPTIONS — PRICES IN EUR *Selected combinations 6–8 weeks delivery time.*

SKU	VARIANT	INCL. VAT	EXCL. VAT
Textile — Seat with upholstery — Powder coated steel base — Black steel			
9480001	PRICE CATEGORY 1 Maple, Kvadrat / Remix 2, Kvadrat / City Velvet, JAB / Hot Madison Reloaded, JAB / Gaja C2C, Gabriel / Champion, Kvadrat	269,95	225,89
9480002	PRICE CATEGORY 2 Hallingdal 65, Kvadrat / Savanna, Kvadrat / Colline, Kvadrat / Canvas, Kvadrat / Ritz, Nevotex / Fiord, Kvadrat / Steelcut 2, Kvadrat / Steelcut Trio 3, Kvadrat / Moss, Kvadrat / Clay, Kvadrat / Divina Melange, Kvadrat	329,95	276,10
9480003	PRICE CATEGORY 3 Vintage, Astrid / Safire, Kvadrat / Satoriale Collection: Grisaille, Dedar / Ponpon, Dedar	379,95	317,94
9480008	PRICE CATEGORY 4 (NEW) Satoriale Collection: Doppioanama, Dedar / Deco, Dedar Texturologie Collection: Lupo, Dedar / Atlas, Dedar	409,95	343,05
Leather — Seat with upholstery — Powder coated steel base — Black steel			
9480004	PRICE CATEGORY 1 Ultra, Sørensen Leather / Dakar, Nevotex	329,95	276,10
9480005	PRICE CATEGORY 2 Dunes, Sørensen Leather / Shade, Sørensen Leather / Nuance, Sørensen Leather / Instill, Kvadrat	379,95	317,94
9480006	PRICE CATEGORY 3 Royal Nubuck, Sørensen Leather	439,95	368,15
9480007	PRICE CATEGORY 4 Elegance, Sørensen Leather	539,95	451,83

Additional charge of 10% for CMHR foam in accordance with UK requirement.
Option to upholster with customer's own fabric available upon request. For further information please see our upholstery programme on page 464.

Afterroom Bar Stool

BY AFTEROOM

SPEC OPTIONS — PRICES IN EUR *Selected combinations 6–8 weeks delivery time.*

SKU	VARIANT	INCL. VAT	EXCL. VAT
Textile — Seat with upholstery — Powder coated steel base — Black steel			
9470001	PRICE CATEGORY 1 Maple, Kvadrat / Remix 2, Kvadrat / City Velvet, JAB / Hot Madison Reloaded, JAB / Gaja C2C, Gabriel / Champion, Kvadrat	269,95	225,89
9470002	PRICE CATEGORY 2 Hallingdal 65, Kvadrat / Savanna, Kvadrat / Colline, Kvadrat / Canvas, Kvadrat / Ritz, Nevotex / Fiord, Kvadrat / Steelcut 2, Kvadrat / Steelcut Trio 3, Kvadrat / Moss, Kvadrat / Clay, Kvadrat / Divina Melange, Kvadrat	329,95	276,10
9470003	PRICE CATEGORY 3 Vintage, Astrid / Safire, Kvadrat / Satoriale Collection: Grisaille, Dedar / Ponpon, Dedar	379,95	317,94
9470008	PRICE CATEGORY 4 (NEW) Satoriale Collection: Doppioanama, Dedar / Deco, Dedar Texturologie Collection: Lupo, Dedar / Atlas, Dedar	409,95	343,05
Leather — Seat with upholstery — Powder coated steel base — Black steel			
9470004	PRICE CATEGORY 1 Ultra, Sørensen Leather / Dakar, Nevotex	329,95	276,10
9470005	PRICE CATEGORY 2 Dunes, Sørensen Leather / Shade, Sørensen Leather / Nuance, Sørensen Leather / Instill, Kvadrat	379,95	317,94
9470006	PRICE CATEGORY 3 Royal Nubuck, Sørensen Leather	439,95	368,15
9470007	PRICE CATEGORY 4 Elegance, Sørensen Leather	539,95	451,83

Additional charge of 10% for CMHR foam in accordance with UK requirement.
Option to upholster with customer's own fabric available upon request. For further information please see our upholstery programme on page 464.

Afterroom Lounge Chair

BY AFTEROOM

Lounge chair with solid tubular steel rod base chair with padded, upholstered leather seat. Backrest is with double layer stretched leather.



Afterroom Lounge Chair, Black Steel / Dunes 21003, by Afterroom



PRODUCT OPTIONS

SEAT



WITH UPHOLSTERY

POWDER COATED STEEL BASE





BLACK STEEL

Additional charge of 10% for CMHR foam in accordance with UK requirement.

Afterroom Lounge Chair

BY AFTEROOM

STOCK OPTIONS — PRICES IN EUR *Selected combinations up to 2 weeks delivery time.*

SKU	VARIANT	INCL. VAT	EXCL. VAT
Seat with upholstery — Powder coated steel base — Black steel			
8860539	 AFTEROOM LOUNGE CHAIR, BLACK STEEL / DUNES ANTHRAZITE 21003	1.399,95	1.171,48
8860969	 AFTEROOM LOUNGE CHAIR, BLACK STEEL / DUNES COGNAC 21000	1.399,95	1.171,48

TECHNICAL SPECIFICATIONS

PRODUCT TYPE
Lounge chair

ENVIRONMENT
Indoor

DIMENSIONS
H: 75 cm / 29,5"
SH: 36 cm / 14,2"
W: 70 cm / 27,6"
D: 80 cm / 31,5"

PRODUCTION PROCESS
The base is made from bent, welded Ø22 steel tubes with a powder coated finish. Leather upholstery - seat part is stapled onto a plywood construction, while backrest is made from a double layer of leather with double stitching along the edges, riveted in each corner.

COLOUR
Base
Black (RAL 9005)

Seat
Black / Black (Dunes Anthrazite 21003)
Black / Cognac (Dunes Cognac 21000)

GLOSS
Gloss 10-20

MATERIALS
Powder coated steel, plywood, CAL117 foam and upholstery.

WEIGHT
9,65 kg / 35,3 lb

TEST
N / A

CERTIFICATIONS
TSCA title VI compliant

PACKAGING TYPE
Brown box

PACKAGING MEASUREMENTS (H x W x D)
63,5 cm x 121,5 cm x 42,5 cm / 25" x 47,8" x 16,7"

MATERIALS & MAINTENANCE
Please see page 486 for materials and care and maintenance instructions.

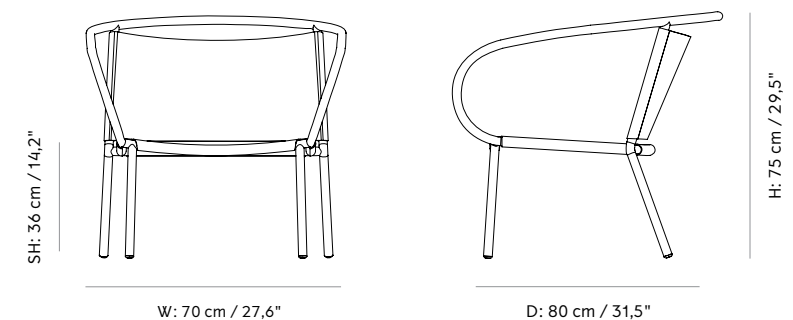

Afterroom Bench

BY AFTEROOM

Bench with powder coated steel base with padded oblong seat in leather and circular black tabletop in Nero Marquina marble.



Afterroom Bench, Black Steel / Nero Marquina Marble / Dunes 21003, by Afterroom



PRODUCT OPTIONS

SEAT



WITH UPHOLSTERY

POWDER COATED STEEL BASE



BLACK STEEL

TABLETOP



NERO MARQUINA MARBLE

SPEC OPTIONS

Available in fabrics from our upholstery programme. Standard lead times apply. Custom upholstery available upon request. For further information please refer to MENU Upholstery Programme.

Additional charge of 10% for CMHR foam in accordance with UK requirement.

Afterroom Bench

BY AFTEROOM

STOCK OPTIONS — PRICES IN EUR *Selected combinations up to 2 weeks delivery time.*

SKU	VARIANT	INCL. VAT	EXCL. VAT
Seat with upholstery — Powder coated steel base — Black steel			
8870530	AFTEROOM BENCH, BLACK STEEL / DUNES ANTHRAZITE 21003	1.299,95	1.087,80

RECOMMENDED COMBINATIONS — PRICES IN EUR *Selected combinations 6–8 weeks delivery time.*

SKU	VARIANT	INCL. VAT	EXCL. VAT
Seat with upholstery — Powder coated steel base — Black steel			
8871960	AFTEROOM BENCH, BLACK STEEL / DUNES COGNAC 21000	1.299,95	1.087,80

TECHNICAL SPECIFICATIONS

PRODUCT TYPE
Bench

ENVIRONMENT
Indoor

DIMENSIONS

H: 60 cm / 23,6"
SH: 45 cm / 17,7"
W: 116 cm / 45,7"
D: 37 cm / 14,6"

PRODUCTION PROCESS

The base is made of bent, welded steel tubes with a powder coated finish. The upholstered seat is made of plywood upholstery shell, foam and fabric. The marble top is CNC-cut and polished and treated with a sealer.

COLOUR

Base
Black (RAL 9005)

Seat
Black / Black (Dunes 21003)
Black / Cognac (Dunes 21000)

Dependent upon selected upholstery.

GLOSS
Gloss 10-20

MATERIALS
Powder coated steel, marquina marble, CAL117 foam and upholstery.

WEIGHT
16 kg / 35,3 lb

TEST
N / A

CERTIFICATIONS
TSCA title VI compliant

PACKAGING TYPE
Brown box

PACKAGING MEASUREMENTS (H x W x D)
63,5 cm x 121,5 cm x 42,5 cm / 25" x 47,8" x 16,7"

MATERIALS & MAINTENANCE
Please see page 486 for materials and care and maintenance instructions.

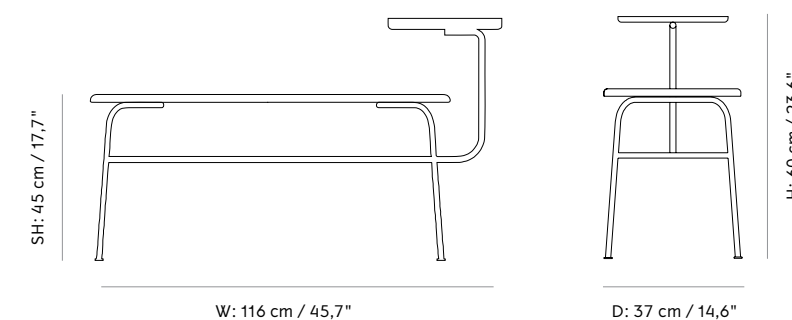

Afteroom Bench

BY AFTEROOM

Afteroom Bench, Black Steel / Nero Marquina Marble / Dunes 21003, by Afteroom

SPEC OPTIONS — PRICES IN EUR *Selected combinations 6–8 weeks delivery time.*

SKU	VARIANT	INCL. VAT	EXCL. VAT
Textile — Seat with upholstery — Powder coated steel base — Black steel — Tabletop — Marquina marble			
8870501	PRICE CATEGORY 1 Maple, Kvadrat / Remix 2, Kvadrat / City Velvet, JAB / Hot Madison Reloaded, JAB / Gaja C2C, Gabriel / Champion, Kvadrat	949,95	794,92
8870502	PRICE CATEGORY 2 Hallingdal 65, Kvadrat / Savanna, Kvadrat / Colline, Kvadrat / Canvas, Kvadrat / Ritz, Nevotex / Fiord, Kvadrat / Steelcut 2, Kvadrat / Steelcut Trio 3, Kvadrat / Moss, Kvadrat / Clay, Kvadrat / Divina Melange, Kvadrat	1.099,95	920,44
8870503	PRICE CATEGORY 3 Vintage, Astrid / Safire, Kvadrat / Satoriale Collection: Grisaille, Dedar / Ponpon, Dedar	1.299,95	1.087,80
8870508	PRICE CATEGORY 4 (NEW) Satoriale Collection: Doppiopanama, Dedar / Deco, Dedar Texturologie Collection: Lupo, Dedar / Atlas, Dedar	1.399,95	1.171,48
Leather seat — Seat with upholstery — Powder coated steel base — Black steel — Tabletop — Marquina marble			
8870504	PRICE CATEGORY 1 Ultra, Sørensen Leather / Dakar, Nevotex	1.099,95	920,44
8870505	PRICE CATEGORY 2 Dunes, Sørensen Leather / Shade, Sørensen Leather / Nuance, Sørensen Leather / Instill, Kvadrat	1.299,95	1.087,80
8870506	PRICE CATEGORY 3 Royal Nubuck, Sørensen Leather	1.489,95	1.246,79
8870507	PRICE CATEGORY 4 Elegance, Sørensen Leather	1.999,95	1.673,56

Additional charge of 10% for CMHR foam in accordance with UK requirement.
Option to upholster with customer's own fabric available upon request. For further information please see our upholstery programme on page 464.



Tearoom Club Chair

BY NICK ROSS

Upholstered club chair with black MDF base.



PRODUCT OPTIONS

SEAT

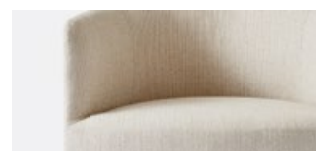

WITH UPHOLSTERY

SPEC OPTIONS

Available in fabrics from our upholstery programme. Standard lead times apply. Custom upholstery available upon request. For further information please refer to MENU Upholstery Programme.



Tearoom Club Chair, City Velvet CA7832/062, by Nick Ross

Tearoom Club Chair

BY NICK ROSS

RECOMMENDED COMBINATIONS — PRICES IN EUR *Selected combinations 6–8 weeks delivery time.*

SKU	VARIANT	INCL. VAT	EXCL. VAT
9600029	TEAROOM CLUB CHAIR, SAVANNA 202	1.609,95	1.347,21
9600259	TEAROOM CLUB CHAIR, CITY VELVET CA7832/062	1.399,95	1.171,48
400263	TEAROOM CLUB CHAIR, TIGER MOUNTAIN T18015/003 (NEW)	2.895,00	2.422,54
400258	TEAROOM CLUB CHAIR, TIGER MOUNTAIN T18015/002 (NEW)	2.895,00	2.422,54

TECHNICAL SPECIFICATIONS

PRODUCT TYPE

Club chair

ENVIRONMENT

Indoor

DIMENSIONS

H: 78 cm / 30,7"
SH: 47 cm / 18,5"
W: 70 cm / 27,6"
D: 58 cm / 22,8"

PRODUCTION PROCESS

The club chair is constructed with a structural frame made of plywood. Seat consists of layered foam (5 layers) in different hardness with webbing/belts and no sag springs underneath. Back and armrests consists of a double foam layer, with front part being reinforced with foam flex. The base is made from painted MDF.

COLOUR

Base
Black (RAL 9005)

Seat
Dependent upon selected upholstery.

GLOSS

Gloss 10-15

MATERIALS

Plywood, HR Foam construction, webbing/belts, No-sag springs, foam flex and upholstery.

WEIGHT

15 kg / 33,1"

TEST

N / A

CERTIFICATIONS

TSCA title IV compliant

PACKAGING TYPE

Brown box

PACKAGING MEASUREMENTS (H x W x D)

80 cm x 72 cm x 60 cm / 31,5" x 28,3" x 23,6"

MATERIALS & MAINTENANCE

Please see page 486 for materials and care and maintenance instructions.

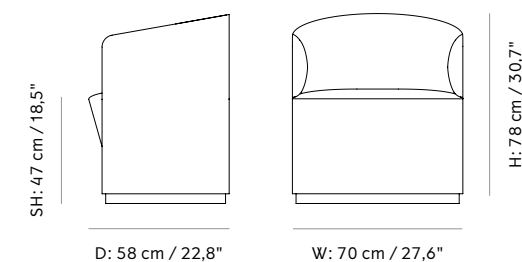

Tearoom Club Chair

BY NICK ROSS

SPEC OPTIONS — PRICES IN EUR *Selected combinations 6–8 weeks delivery time.*

SKU	VARIANT	INCL. VAT	EXCL. VAT
9600001	PRICE CATEGORY 1 Maple, Kvadrat / Remix 2, Kvadrat / City Velvet, JAB / Hot Madison Reloaded, JAB / Gaja C2C, Gabriel / Champion, Kvadrat	1.399,95	1.171,48
9600002	PRICE CATEGORY 2 Hallingdal 65, Kvadrat / Savanna, Kvadrat / Colline, Kvadrat / Canvas, Kvadrat / Ritz, Nevotex / Fiord, Kvadrat / Steelcut 2, Kvadrat / Steelcut Trio 3, Kvadrat / Moss, Kvadrat / Clay, Kvadrat / Divina Melange, Kvadrat	1.609,95	1.347,21
9600003	PRICE CATEGORY 3 Vintage, Astrid / Safire, Kvadrat / Satoriale Collection: Grisaille, Dedar / Ponpon, Dedar	1.819,95	1.522,93
9600008	PRICE CATEGORY 4 (NEW) Satoriale Collection: Doppiopanama, Dedar / Deco, Dedar Texturologie Collection: Lupo, Dedar / Atlas, Dedar	2.029,95	1.698,66

Additional charge of 10% for CMHR foam in accordance with UK requirement.
Option to upholster with customer's own fabric available upon request. For further information please see our upholstery programme on page 464.



Circular Lamp, Black Aluminum, by Studio WM
Harbour Column Dining Table, Ø80, Black Steel / Estremoz Marble, by Norm Architects
Tearoom Lounge Chair, Schwartzwald 002, by Nick Ross
Gravel Rug, Ivory, by Nina Bruun

Tearoom Lounge Chair

BY NICK ROSS

Upholstered lounge chair with black MDF base.



PRODUCT OPTIONS

SEAT

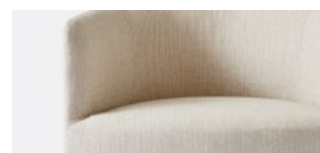

WITH UPHOLSTERY

SPEC OPTIONS

Available in fabrics from our upholstery programme. Standard lead times apply. Custom upholstery available upon request. For further information please refer to MENU Upholstery Programme.

Tearoom Lounge Chair, Savanna 202, by Nick Ross
Cast Sconce Wall Lamp, by Thomas Chung & Jordan Murphy

Tearoom Lounge Chair

BY NICK ROSS

RECOMMENDED COMBINATIONS — PRICES IN EUR *Selected combinations 6–8 weeks delivery time.*

SKU	VARIANT	INCL. VAT	EXCL. VAT
9605029	TEAROOM LOUNGE CHAIR, SAVANNA 202	2.359,95	1.974,81
9605259	TEAROOM LOUNGE CHAIR, CITY VELVET CA7832/062	2.049,95	1.715,40
400264	TEAROOM LOUNGE CHAIR, DECO 001 (NEW)	2.995,00	2.506,22
400257	TEAROOM LOUNGE CHAIR, SCHWARTZWALD T18049/002 (NEW)	3.095,00	2.589,90

TECHNICAL SPECIFICATIONS

PRODUCT TYPE
Lounge chair

ENVIRONMENT
Indoor

DIMENSIONS
H: 78 cm / 30,7"
SH: 47 cm / 18,5"
W: 89 cm / 35"
D: 70 cm / 27,6"

PRODUCTION PROCESS
The Lounge Chair is constructed with a structural frame made of plywood. The seat consists of layered foam (5 layers) in different hardness with webbing/belts and no-sag springs underneath. Back and armrests consist of a double foam layer with front part reinforced with foam flex. The base is made of painted MDF.

COLOUR
Base
Black (RAL 9005)

Seat
Dependent upon selected upholstery.

GLOSS
Gloss 10-15

MATERIALS
Plywood, HR Foam construction, webbing/belts, No-sag springs, foam flex and upholstery.

WEIGHT
18 kg / 39,7"

TEST
N / A

CERTIFICATIONS
TSCA title IV compliant

PACKAGING TYPE
Brown box

PACKAGING MEASUREMENTS (H x W x D)
80 cm x 92 cm x 72 cm / 31,5" x 36,2" x 28,3"

MATERIALS & MAINTENANCE
Please see page 486 for materials and care and maintenance instructions.

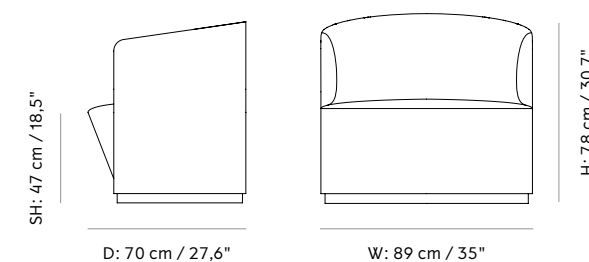

Tearoom Lounge Chair

BY NICK ROSS

SPEC OPTIONS — PRICES IN EUR *Selected combinations 6–8 weeks delivery time.*

SKU	VARIANT	INCL. VAT	EXCL. VAT
9605001	PRICE CATEGORY 1 Maple, Kvadrat / Remix 2, Kvadrat / City Velvet, JAB / Hot Madison Reloaded, JAB / Gaja C2C, Gabriel / Champion, Kvadrat	2.049,95	1.715,40
9605002	PRICE CATEGORY 2 Hallingdal 65, Kvadrat / Savanna, Kvadrat / Colline, Kvadrat / Canvas, Kvadrat / Ritz, Nevotex / Fiord, Kvadrat / Steelcut 2, Kvadrat / Steelcut Trio 3, Kvadrat / Moss, Kvadrat / Clay, Kvadrat / Divina Melange, Kvadrat	2.359,95	1.974,81
9605003	PRICE CATEGORY 3 Vintage, Astrid / Safire, Kvadrat / Satoriale Collection: Grisaille, Dedar / Ponpon, Dedar	2.669,95	2.234,21
9605008	PRICE CATEGORY 4 (NEW) Satoriale Collection: Doppiopanama, Dedar / Deco, Dedar Texturologie Collection: Lupo, Dedar / Atlas, Dedar	2.979,95	2.493,62

Tearoom Lounge Chair, Deco Avorio T14035 001, by Nick Ross
Échasse Vase, Medium, Smoke Glass / Brushed Brass, by Theresa Rand
Troll Vase, Amber, by Anderssen & Voll
Échasse Hurricane, Smoke Glass / Brushed Brass, by Theresa Rand
Harbour Column Lounge Table w/ Star Base, by Norm Architects



Additional charge of 10% for CMHR foam in accordance with UK requirement.
Option to upholster with customer's own fabric available upon request. For further information please see our upholstery programme on page 464.

Tearoom Sofa

BY NICK ROSS

Upholstered sofa with black MDF base.

PRODUCT OPTIONS

SEAT

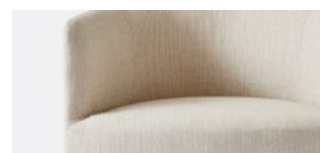

WITH UPHOLSTERY

SPEC OPTIONS

Available in fabrics from our upholstery programme. Standard lead times apply. Custom upholstery available upon request. For further information please refer to MENU Upholstery Programme.



Tearoom Sofa, Savanna 202, by Nick Ross
Tearoom Sofa, City Velvet CA7832/062, by Nick Ross

Tearoom Sofa

BY NICK ROSS

RECOMMENDED COMBINATIONS — PRICES IN EUR *Selected combinations 6–8 weeks delivery time.*

SKU	VARIANT	INCL. VAT	EXCL. VAT
9602029	 TEAROOM SOFA, SAVANNA 202	4.089,95	3.422,47
9602259	 TEAROOM SOFA, CITY VELVET CA7832/062	3.549,95	2.970,60
400266	 TEAROOM SOFA, ARCTIC 040 (NEW)	3.995,00	3.343,02

TECHNICAL SPECIFICATIONS

PRODUCT TYPE
Sofa

ENVIRONMENT
Indoor

DIMENSIONS
H: 78 cm / 30,7"
SH: 47 cm / 18,5"
W: 190 cm / 42,9"
D: 70 cm / 27,6"

PRODUCTION PROCESS
The Lounge Chair is constructed with a structural frame made of plywood. The seat consists of layered foam (5 layers) in different hardness with webbing/belts and no-sag springs underneath. Back and armrests consist of a double foam layer with front part reinforced with foam flex. The base is made of painted MDF.

COLOUR
Base
Black (RAL 9005)

Seat
Dependent upon selected upholstery.

GLOSS
Gloss 10-15

MATERIALS
Plywood, HR foam, available with CAL117 and CMHR construction, webbing / belts, no sag springs, foam flex and textile.

WEIGHT
28 kg / 61,7"

TEST
N / A

CERTIFICATIONS
TSCA title IV compliant

PACKAGING TYPE
Brown box

PACKAGING MEASUREMENTS (H x W x D)
80 cm x 192 cm x 72 cm / 31,5" x 75,6" x 28,3"

MATERIALS & MAINTENANCE
Please see page 486 for materials and care and maintenance instructions.

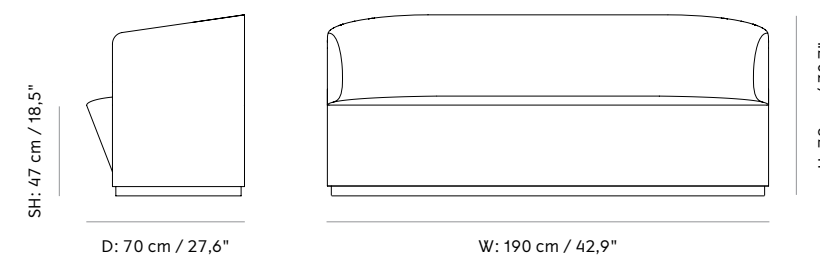

Tearoom Sofa

BY NICK ROSS

Tearoom Sofa, Savanna 202, by Nick Ross

SPEC OPTIONS — PRICES IN EUR *Selected combinations 6–8 weeks delivery time.*

SKU	VARIANT	INCL. VAT	EXCL. VAT
9602001	PRICE CATEGORY 1 Maple, Kvadrat / Remix 2, Kvadrat / City Velvet, JAB / Hot Madison Reloaded, JAB / Gaja C2C, Gabriel / Champion, Kvadrat	3.549,95	2.970,60
9602002	PRICE CATEGORY 2 Hallingdal 65, Kvadrat / Savanna, Kvadrat / Colline, Kvadrat / Canvas, Kvadrat / Ritz, Nevotex / Fiord, Kvadrat / Steelcut 2, Kvadrat / Steelcut Trio 3, Kvadrat / Moss, Kvadrat / Clay, Kvadrat / Divina Melange, Kvadrat	4.089,95	3.422,47
9602003	PRICE CATEGORY 3 Vintage, Astrid / Safire, Kvadrat / Satoriale Collection: Grisaille, Dedar / Ponpon, Dedar	4.619,95	3.865,97
9602008	PRICE CATEGORY 4 (NEW) Satoriale Collection: Doppioanama, Dedar / Deco, Dedar Texturologie Collection: Lupo, Dedar / Atlas, Dedar	5.149,95	4.309,48



Additional charge of 10% for CMHR foam in accordance with UK requirement.
Option to upholster with customer's own fabric available upon request. For further information please see our upholstery programme on page 464.

Synnes Chair

BY FALKE SVATUN

Chair made of natural oak or painted ash with the option of an upholstered seat.



PRODUCT OPTIONS

SEAT



WITHOUT UPHOLSTERY



WITH UPHOLSTERY

BASE & BACK



NATURAL OAK



BLACK ASH

SPEC OPTIONS

Available in fabrics from our upholstery programme. Standard lead times apply. Custom upholstery available upon request. For further information please refer to MENU Upholstery Programme.

Synnes Dining Chair, Natural Oak / Royal Nubuck Cinnamon 30275, by Falke Svatun

Synnes Chair

BY FALKE SVATUN

TECHNICAL SPECIFICATIONS

PRODUCT TYPE

Dining chair

ENVIRONMENT

Indoor

DIMENSIONS

H: 80 cm / 31,5"

SH: 45 cm / 17,7"

L: 47,5 cm / 18,7"

D: 48,5 cm / 19,1"

PRODUCTION PROCESS

Painted black ash or natural oak with or without a upholstered seat.

COLOUR

Base

Natural oak

Black ash

Seat with upholstery

Dependent upon selected upholstery

Seat without upholstery

Natural oak

Black ash

GLOSS

N / A

MATERIALS

Natural oak or painted ash, CAL117 foam, upholstery

WEIGHT

Without upholstered seat: 5,4 kg / 11,9 lb

With upholstered seat: 5,7 kg / 12,6 lb

TEST

EN1022:2005, L2

EN16139:2013, L2

CERTIFICATIONS

N / A

PACKAGING TYPE

Brown box

PACKAGING MEASUREMENTS (H x W x D)

84 cm x 49 cm x 49 cm / 33,1" x 19,3" x 19,3"

MATERIALS & MAINTENANCE



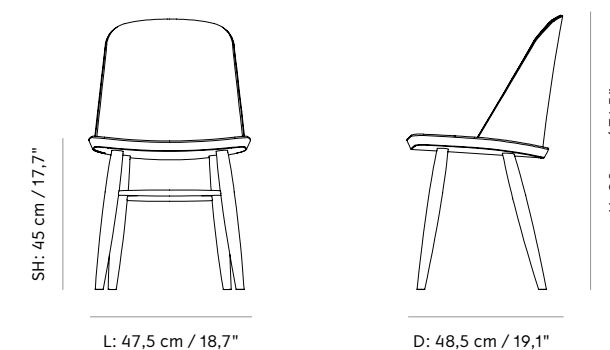

Please see page 486 for materials and care and maintenance instructions.



Synnes Chair

BY FALKE SVATUN

QUICK SHIP OPTIONS — PRICES IN EUR *Selected combinations up to 4 weeks delivery time.*

SKU	VARIANT	INCL. VAT	EXCL. VAT
Seat without upholstery — Oak / Ash backrest and base — Natural oak / Black ash			
7900039	 SYNNES CHAIR, NATURAL OAK	429,95	359,78
7900539	 SYNNES CHAIR, BLACK ASH	429,95	359,78
Seat with upholstery — Oak / Ash backrest and base — Natural oak / black ash			
7925939	 SYNNES CHAIR, BLACK ASH / COLLINE 568	499,95	418,36
7920979	 SYNNES CHAIR, NATURAL OAK / DAKAR 0250	559,95	468,57
7925559	 SYNNES CHAIR, BLACK ASH / DAKAR 0842	559,95	468,57

Additional charge of 10% for CMHR foam in accordance with UK requirement.
Option to upholster with customer's own fabric available upon request. For further information please see our upholstery programme on page 464.

Synnes Chair

BY FALKE SVATUN

SPEC OPTIONS — PRICES IN EUR *Selected combinations 6–8 weeks delivery time.*

SKU	VARIANT	INCL. VAT	EXCL. VAT
Textile — Seat with upholstery — Oak / Ash backrest and base — Natural oak / Black ash			
7900001	PRICE CATEGORY 1 Maple, Kvadrat / Remix 2, Kvadrat / City Velvet, JAB / Hot Madison Reloaded, JAB / Gaja C2C, Gabriel / Champion, Kvadrat	429,95	355,31
7900002	PRICE CATEGORY 2 Hallingdal 65, Kvadrat / Savanna, Kvadrat / Colline, Kvadrat / Canvas, Kvadrat / Ritz, Nevotex / Fiord, Kvadrat / Steelcut 2, Kvadrat / Steelcut Trio 3, Kvadrat / Moss, Kvadrat / Clay, Kvadrat / Divina Melange, Kvadrat	499,95	413,16
7900003	PRICE CATEGORY 3 Vintage, Astrid / Safire, Kvadrat / Satoriale Collection: Grisaille, Dedar / Ponpon, Dedar	559,95	462,74
7900008	PRICE CATEGORY 4 (NEW) Satoriale Collection: Doppiopanama, Dedar / Deco, Dedar Texturologie Collection: Lupo, Dedar / Atlas, Dedar	609,95	510,41
Leather — Seat with upholstery — Oak / Ash backrest and base — Natural oak / Black ash			
7900004	PRICE CATEGORY 1 Ultra, Sørensen Leather / Dakar, Nevotex	559,95	462,74
7900005	PRICE CATEGORY 2 Dunes, Sørensen Leather / Shade, Sørensen Leather	609,95	510,41
7900006	PRICE CATEGORY 3 Royal Nubuck, Sørensen Leather	689,95	577,35
7900007	PRICE CATEGORY 4 Elegance, Sørensen Leather	779,95	652,66

Additional charge of 10% for CMHR foam in accordance with UK requirement.
Option to upholster with customer's own fabric available upon request. For further information please see our upholstery programme on page 464.

Snaregade Dining Table, Rectangular

BY NORM ARCHITECTS

Rectangular dining table with a tabletop in linoleum or painted oak veneer set on a powder coated steel base.

PRODUCT OPTIONS

TABLETOP



CHARCOAL LINOLEUM

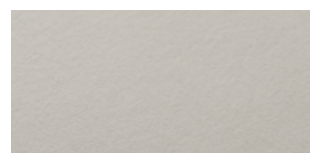

MUSHROOM LINOLEUM



BLACK OAK



LIGHT GREY OAK

POWDER COATED STEEL BASE



BLACK STEEL



LIGHT GREY STEEL

Snaregade Dining Table, Rectangular, Black Steel / Black Oak, by Norm Architects

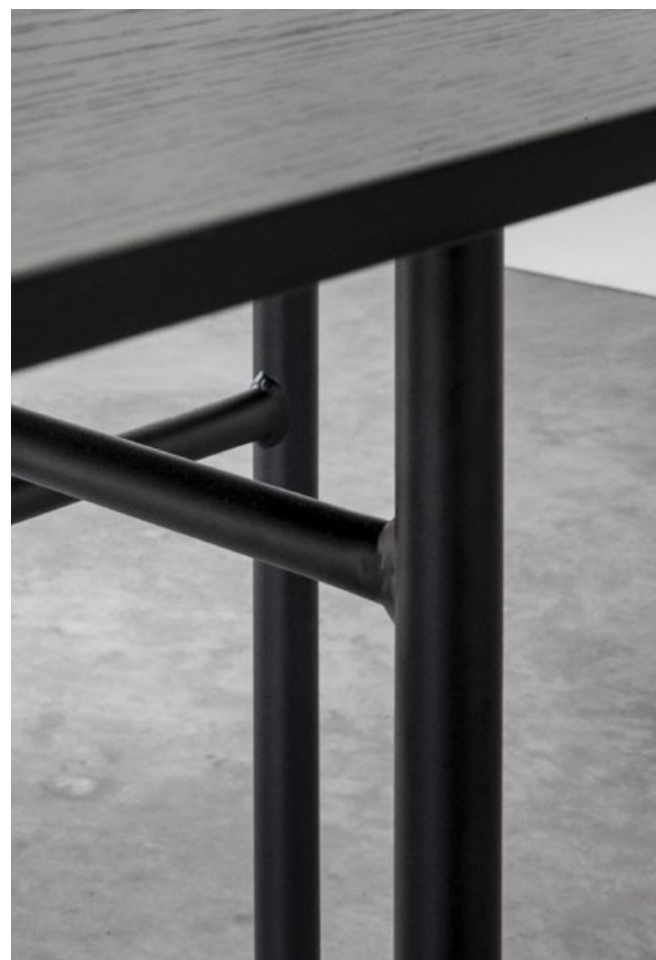

Snaregade Dining Table, Rectangular

BY NORM ARCHITECTS

STOCK OPTIONS — PRICES IN EUR *Selected combinations up to 2 weeks delivery time.*

SKU	VARIANT	INCL. VAT	EXCL. VAT
1150149	SNAREGADE RECTANGULAR, BLACK STEEL / CHARCOAL LINOLEUM	1.999,95	1.673,56
1150539	SNAREGADE RECTANGULAR, BLACK STEEL / BLACK OAK	1.999,95	1.673,56

SPEC OPTIONS — PRICES IN EUR *Selected combinations 6–8 weeks delivery time.*

SKU	VARIANT	INCL. VAT	EXCL. VAT
1150689	SNAREGADE RECTANGULAR, LIGHT GREY STEEL / MUSHROOM LINOLEUM	1.999,95	1.673,56
1150139	SNAREGADE RECTANGULAR, LIGHT GREY STEEL / LIGHT GREY OAK	1.999,95	1.673,56
1150159	SNAREGADE RECTANGULAR, LIGHT GREY / BLACK OAK	1.999,95	1.673,56
1150189	SNAREGADE RECTANGULAR, LIGHT GREY / CHARCOAL LINOLEUM	1.999,95	1.673,56
1150559	SNAREGADE RECTANGULAR, BLACK STEEL / LIGHT GREY OAK	1.999,95	1.673,56
1150679	SNAREGADE RECTANGULAR, BLACK STEEL / MUSHROOM LINOLEUM	1.999,95	1.673,56

TECHNICAL SPECIFICATIONS

PRODUCT TYPE
Dining table

ENVIRONMENT
Indoor

DIMENSIONS
H: 73 cm / 28,7"
D: 90 cm / 35,4"
L: 200 cm / 78,7"

PRODUCTION PROCESS
The tabletop is made from painted oak veneer or forbo linoleum glued on MDF, CNC machine-cut and painted to match the linoleum. The frame is welded together from steel tubes and surface finished with powder coating.

COLOUR

Base
Black (RAL 9005)
Light grey (RAL 9002)

Linoleum tabletop
Charcoal (Forbo) S 8502-B
Mushroom (Forbo) S 2002-Y

Wooden tabletop
Black (RAL 9005)
Light grey (RAL 9002)

GLOSS
Gloss 10-20

MATERIALS
Linoleum or painted oak veneer on MDF and powder coated steel.

WEIGHT
50,8 kg / 112 lb

TEST
EN 15372:2016, L2

CERTIFICATIONS
TSCA title VI compliant

PACKAGING TYPE
Brown box

PACKAGING MEASUREMENTS (H x W x D)
19 cm x 205,5 cm x 96 cm / 7,5" x 80,1" x 37,8"

MATERIALS & MAINTENANCE
Please see page 486 for materials and care and maintenance instructions.

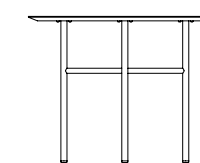

D: 95 cm / 37,4"

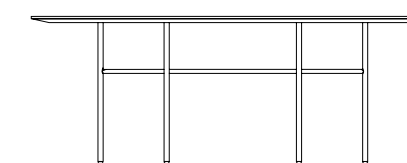

L: 200 cm / 78,7"

H: 74 cm / 29,1"

Snaregade Dining Table, Oval

BY NORM ARCHITECTS

Oval dining table, with a tabletop in linoleum, painted oak veneer or soap treated solid wood set on a powder coated steel base.

PRODUCT OPTIONS

TABLETOP



CHARCOAL LINOLEUM

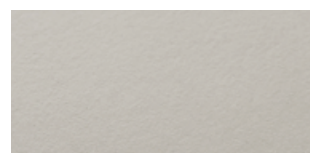

MUSHROOM LINOLEUM



BLACK OAK



LIGHT GREY OAK

POWDER COATED STEEL BASE



BLACK STEEL



LIGHT GREY STEEL



Harbour Dining Chair, Steel Base, Black/Dakar 0311, by Norm Architects
 Snaregade Dining Table, Oval, Black/Charcoal Linoleum, by Norm Architects
 Cyclades Vase, Large, Sand, by Nick Ross
 Échasse Bowl, Small, Smoke/Brushed Brass, by Theresa Rand
 New Norm Dinnerware, Dark Glazed, by Norm Architects
 Stackable Glasses, by Norm Architects Bottle
 Carafe, 1 L, Clear Glass/Brass, by Norm Architects

Snaregade Dining Table, Oval

BY NORM ARCHITECTS

STOCK OPTIONS — PRICES IN EUR *Selected combinations up to 2 weeks delivery time.*

SKU	VARIANT	INCL. VAT	EXCL. VAT
1151149	SNAREGADE OVAL, BLACK STEEL / CHARCOAL LINOLEUM	1.999,95	1.673,56
1151539	SNAREGADE OVAL, BLACK STEEL / BLACK OAK	1.999,95	1.673,56

SPEC OPTIONS — PRICES IN EUR *Selected combinations 6–8 weeks delivery time.*

SKU	VARIANT	INCL. VAT	EXCL. VAT
1151689	SNAREGADE OVAL, LIGHT GREY STEEL / MUSHROOM LINOLEUM	1.999,95	1.673,56
1151139	SNAREGADE OVAL, LIGHT GREY STEEL / LIGHT GREY OAK	1.999,95	1.673,56

TECHNICAL SPECIFICATIONS

PRODUCT TYPE Dining table	COLOUR Base Black (RAL 9005) Light grey (RAL 9002)	WEIGHT 38,8 kg / 85,6 lb
ENVIRONMENT Indoor	Linoleum tabletop Charcoal (Forbo) S 8502-B Mushroom (Forbo) S 2002-Y	TEST N / A
DIMENSIONS H: 73 cm / 28,7" D: 95 cm / 37,4" L: 210 cm / 82,7"	Wooden tabletop Black (RAL 9005) Light grey (RAL 9002)	CERTIFICATIONS TSCA title VI compliant
PRODUCTION PROCESS The tabletop is made from painted oak veneer or forbo linoleum glued on MDF, CNC machine-cut and painted to match the linoleum. The frame is welded together from steel tubes and surface finished with powder coating.	GLOSS Gloss 10-20	PACKAGING TYPE Brown box
MATERIALS Linoleum, painted oak veneer on MDF and powder coated steel.		PACKAGING MEASUREMENT (H x W x D) 19 cm x 210 cm x 95 cm / 7,5" x 82,7" x 37,4"
		MATERIALS & MAINTENANCE Please see page 486 for materials and care and maintenance instructions.

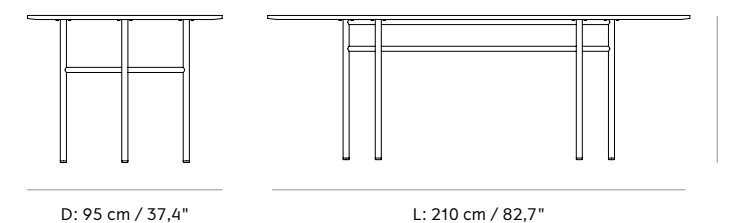

Snaregade Dining Table, Ø120

BY NORM ARCHITECTS

Round dining table with a tabletop in linoleum or painted oak veneer set on a powder coated steel base.

Synnes Chair, Natural Oak, by Falke Svaton
 Snaregade Dining Table, Ø138, Black Steel / Black Oak, by Norm Architects
 New Norm Dinnerware, Dark Glazed, by Norm Architects
 Échasse Bowl, Large, Smoke Glass / Brushed Brass, by Theresa Rand
 Échasse Vase, Small, Smoke Glass / Brushed Brass, by Theresa Rand
 Gravel Rug, Ivory, by Nina Bruun



PRODUCT OPTIONS

TABLETOP



CHARCOAL LINOLEUM

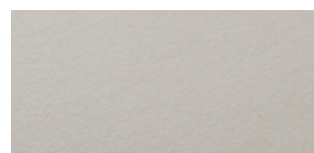

MUSHROOM LINOLEUM

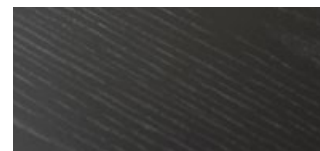

BLACK OAK



LIGHT GREY OAK

POWDER COATED STEEL BASE



BLACK STEEL



LIGHT GREY STEEL

Snaregade Dining Table, Ø120

BY NORM ARCHITECTS

STOCK OPTIONS — PRICES IN EUR *Selected combinations up to 2 weeks delivery time.*

SKU	VARIANT	INCL. VAT	EXCL. VAT
1153149	SNAREGADE ROUND, Ø120, BLACK STEEL / CHARCOAL LINOLEUM	1,499,95	1,255,16
1153539	SNAREGADE ROUND, Ø120, BLACK STEEL / BLACK OAK	1,499,95	1,255,16

SPEC OPTIONS — PRICES IN EUR *Selected combinations 6–8 weeks delivery time.*

SKU	VARIANT	INCL. VAT	EXCL. VAT
1153689	SNAREGADE ROUND, Ø120, LIGHT GREY STEEL / MUSHROOM LINOLEUM	1,499,95	1,255,16
1153139	SNAREGADE ROUND, Ø120, LIGHT GREY STEEL / LIGHT GREY OAK	1,499,95	1,255,16

TECHNICAL SPECIFICATIONS

PRODUCT TYPE
Dining table

ENVIRONMENT
Indoor

DIMENSIONS
H: 73 cm / 28,7"
Ø: 120 cm / 47,2"

PRODUCTION PROCESS
The tabletop is made from painted oak veneer or forbo linoleum glued on MDF, CNC machine-cut and painted to match the linoleum. The frame is welded together from steel tubes and surface finished with powder coating.

COLOUR
Base
Black (RAL 9005)
Light grey (RAL 9002)

Linoleum tabletop
Charcoal (Forbo) S 8502-B
Mushroom (Forbo) S 2002-Y

Wooden tabletop
Black (RAL 9005)
Light grey (RAL 9002)

MATERIALS
Linoleum or painted oak veneer on MDF, and powder coated steel.

GLOSS
Gloss 10-20

WEIGHT
26,9 kg / 59,3 lb

TEST
N / A

CERTIFICATIONS
TSCA title VI compliant

PACKAGING TYPE
Brown box

PACKAGING MEASUREMENTS (H x W x D)
19 cm x 127 cm x 127 cm / 7,5" x 50" x 50"

MATERIALS & MAINTENANCE
Please see page 486 for materials and care and maintenance instructions.

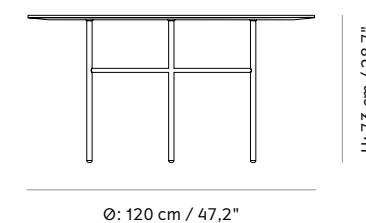

Snaregade Dining Table, Ø138

BY NORM ARCHITECTS

Round dining table with a tabletop in linoleum or painted oak veneer set on a powder coated steel base.

PRODUCT OPTIONS

TABLETOP



CHARCOAL LINOLEUM

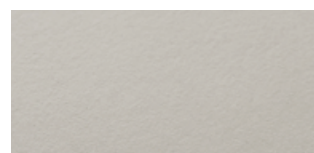

MUSHROOM LINOLEUM



BLACK OAK



LIGHT GREY OAK

POWDER COATED STEEL BASE

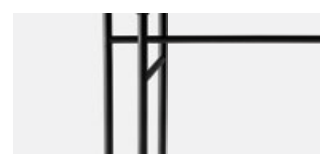

BLACK STEEL



LIGHT GREY STEEL

Snaregade Dining Table, Ø138, Black Steel / Black Oak, by Norm Architects
Synnes Dining Chair, Black Ash / Dakar Leather 0842, by Falke Svaton



Snaregade Dining Table, Ø138

BY NORM ARCHITECTS

STOCK OPTIONS — PRICES IN EUR

Selected combinations up to 2 weeks delivery time.

SKU	VARIANT	INCL. VAT	EXCL. VAT
1152149	SNAREGADE ROUND, Ø138, BLACK STEEL / CHARCOAL LINOLEUM	1.899,95	1.589,88
1152539	SNAREGADE ROUND, Ø138, BLACK STEEL / BLACK OAK	1.899,95	1.589,88

SPEC OPTIONS — PRICES IN EUR

Selected combinations 6–8 weeks delivery time.

SKU	VARIANT	INCL. VAT	EXCL. VAT
1152689	SNAREGADE ROUND, Ø138, LIGHT GREY STEEL / MUSHROOM LINOLEUM	1.899,95	1.589,88
1152139	SNAREGADE ROUND, Ø138, LIGHT GREY STEEL / LIGHT GREY OAK	1.899,95	1.589,88

TECHNICAL SPECIFICATIONS

PRODUCT TYPE
Dining table

ENVIRONMENT
Indoor

DIMENSIONS
H: 73 cm / 28,7"
Ø: 138 cm / 54,3"

PRODUCTION PROCESS
The tabletop is made from painted oak veneer or forbo linoleum glued on MDF, CNC machine-cut and painted to match the linoleum. The frame is welded together from steel tubes and surface finished with powder coating.

COLOUR

Base
Black (RAL 9005)
Light grey (RAL 9002)

Linoleum tabletop
Charcoal (Forbo) S 8502-B
Mushroom (Forbo) S 2002-Y

Wooden tabletop
Black (RAL 9005)
Light grey (RAL 9002)

MATERIALS
Linoleum or painted oak veneer on MDF, and powder coated steel.

GLOSS
Gloss 10-20

WEIGHT
30,9 kg / 68,1 lb

TEST
N / A

CERTIFICATIONS
TSCA title VI compliant

PACKAGING TYPE
Brown box

PACKAGING MEASUREMENTS (H x W x D)
19 cm x 140 cm x 140 cm / 7,5" x 55,1" x 55,1"

MATERIALS & MAINTENANCE
Please see page 486 for materials and care and maintenance instructions.

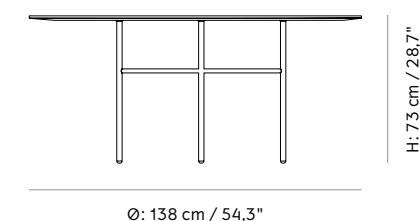

Snaregade Counter Table

BY NORM ARCHITECTS

Rectangular counter table, with a tabletop in linoleum or painted oak veneer set on a powder coated steel base.

PRODUCT OPTIONS

TABLETOP



CHARCOAL LINOLEUM



MUSHROOM LINOLEUM

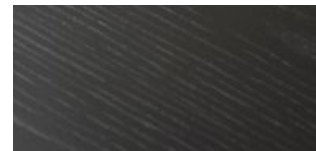

BLACK OAK

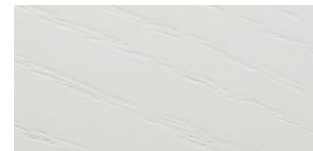

LIGHT GREY OAK

POWDER COATED STEEL BASE



BLACK STEEL

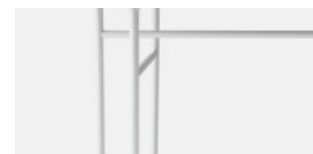

LIGHT GREY STEEL



Snaregade Counter Table, Black Steel / Charcoal Linoleum, by Norm Architects

Snaregade Counter Table

BY NORM ARCHITECTS

SPEC OPTIONS — PRICES IN EUR *Selected combinations 6–8 weeks delivery time.*

SKU	VARIANT	INCL. VAT	EXCL. VAT
1158149	SNAREGADE COUNTER TABLE, BLACK STEEL / CHARCOAL LINOLEUM	2.149,95	1.799,08
1158689	SNAREGADE COUNTER TABLE, BLACK STEEL / MUSHROOM LINOLEUM	2.149,95	1.799,08
1158189	SNAREGADE COUNTER TABLE, LIGHT GREY STEEL / CHARCOAL LINOLEUM	2.149,95	1.799,08
1158179	SNAREGADE COUNTER TABLE, LIGHT GREY STEEL / MUSHROOM LINOLEUM	2.149,95	1.799,08
1158539	SNAREGADE COUNTER TABLE, BLACK STEEL / BLACK OAK	2.149,95	1.799,08
1158559	SNAREGADE COUNTER TABLE, BLACK STEEL / LIGHT GREY OAK	2.149,95	1.799,08
1158159	SNAREGADE COUNTER TABLE, LIGHT GREY STEEL / BLACK OAK	2.149,95	1.799,08
1158139	SNAREGADE COUNTER TABLE, LIGHT GREY STEEL / LIGHT GREY OAK	2.149,95	1.799,08

TECHNICAL SPECIFICATIONS

PRODUCT TYPE
Counter table

ENVIRONMENT
Indoor

DIMENSIONS
H: 92,7 cm / 36,5"
D: 90 cm / 35,4"
W: 200 cm / 78,7"

PRODUCTION PROCESS
The tabletop is made from painted oak veneer or forbo linoleum glued on MDF, CNC machine-cut and painted to match the linoleum. The frame is welded together from steel tubes and surface finished with powder coating.

COLOUR
Base
Black (RAL 9005)
Light grey (RAL 9002)

Linoleum tabletop
Charcoal (Forbo) S 8502-B
Mushroom (Forbo) S 2002-Y

Wooden tabletop
Black (RAL 9005)
Light grey (RAL 9002)

MATERIALS
Linoleum or painted oak veneer on MDF, and powder coated steel.

GLOSS
Gloss 10-20

WEIGHT
59 kg / 130,2 lb

TEST
EN 15372:2016, L2

CERTIFICATIONS
TSCA title VI compliant

PACKAGING TYPE
Brown box

PACKAGING MEASUREMENTS (H x W x D)
30 cm x 96,5 cm x 206,5 / 11,8" x 38" x 81,3"

MATERIALS & MAINTENANCE
Please see page 486 for materials and care and maintenance instructions.

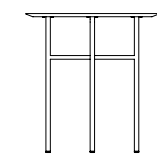

D: 90 cm / 35,4"

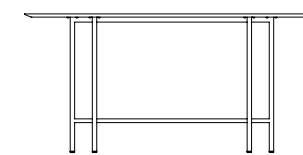

W: 200 cm / 78,7"



H: 92,7 cm / 36,5"

Snaregade Bar Table

BY NORM ARCHITECTS

Rectangular bar table with a tabletop in linoleum or painted oak veneer set on a powder coated steel frame.

PRODUCT OPTIONS

TABLETOP



CHARCOAL LINOLEUM

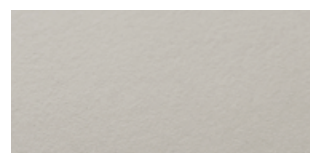

MUSHROOM LINOLEUM



BLACK OAK



LIGHT GREY OAK

POWDER COATED STEEL BASE



BLACK STEEL



LIGHT GREY STEEL

Snaregade Bar Table, Light Grey Oak / Light Grey Oak, by Norm Architects
Afteroom Counter Chair, Black Steel / Gaja C2C 61115, by Afteroom



Snaregade Bar Table

BY NORM ARCHITECTS

SPEC OPTIONS — PRICES IN EUR *Selected combinations 6–8 weeks delivery time.*

SKU	VARIANT	INCL. VAT	EXCL. VAT
1157149	SNAREGADE BAR TABLE, BLACK STEEL / CHARCOAL LINOLEUM	2.149,95	1.799,08
1157689	SNAREGADE BAR TABLE, BLACK STEEL / MUSHROOM LINOLEUM	2.149,95	1.799,08
1157189	SNAREGADE BAR TABLE, LIGHT GREY STEEL / CHARCOAL LINOLEUM	2.149,95	1.799,08
1157179	SNAREGADE BAR TABLE, LIGHT GREY STEEL / MUSHROOM LINOLEUM	2.149,95	1.799,08
1157539	SNAREGADE BAR TABLE, BLACK STEEL / BLACK OAK	2.149,95	1.799,08
1157559	SNAREGADE BAR TABLE, BLACK STEEL / LIGHT GREY OAK	2.149,95	1.799,08
1157159	SNAREGADE BAR TABLE, LIGHT GREY STEEL / BLACK OAK	2.149,95	1.799,08
1157139	SNAREGADE BAR TABLE, LIGHT GREY STEEL / LIGHT GREY OAK	2.149,95	1.799,08

TECHNICAL SPECIFICATIONS

PRODUCT TYPE
Bar table

ENVIRONMENT
Indoor

DIMENSIONS
H: 102,7 cm / 40,4"
D: 90 cm / 35,4"
W: 200 cm / 78,7"

PRODUCTION PROCESS
The tabletop is made from painted oak veneer or forbo linoleum glued on MDF, CNC machine-cut and painted to match the linoleum. The frame is welded together from steel tubes and surface finished with powder coating.

COLOUR
Base
Black (RAL 9005)
Light grey (RAL 9002)

Linoleum tabletop
Charcoal (Forbo) S 8502-B
Mushroom (Forbo) S 2002-Y

Wooden tabletop
Black (RAL 9005)
Light grey (RAL 9002)

MATERIALS
Linoleum or painted oak veneer on MDF, and powder coated steel.

GLOSS
Gloss 10-20

WEIGHT
62 kg / 136,7 lb

TEST
EN 15372:2016, L2

CERTIFICATIONS
TSCA title VI compliant

PACKAGING TYPE
Brown box

PACKAGING MEASUREMENTS (H x W x D)
30 cm x 96,5 cm x 206,5 / 11,8" x 38" x 81,3"

MATERIALS & MAINTENANCE
Please see page 486 for materials and care and maintenance instructions.

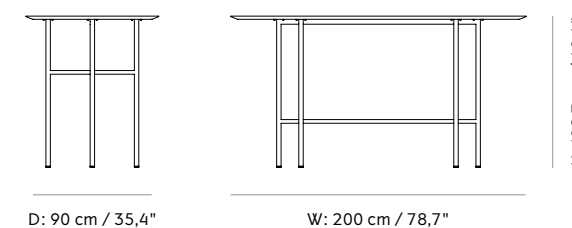

Afteroom Bar Chair, Black Steel / Ritz 8469, by Afteroom
Snaregade Bar Table, Black Steel / Charcoal Linoleum, by Norm Architects
Task Pendant, by Gry Holmskov

Snaregade Tabletop, Connector Fitting Set

BY NORM ARCHITECTS

PRODUCT OPTIONS

Snaregade Table connectors for bar and counter versions are easy to install to join tables together. Ideal for retrofitting office furniture with a team-oriented environment in mind or extending communal spaces for special events.

STOCK OPTIONS — PRICES IN EUR *Selected combinations up to 2 weeks delivery time.*

SKU	VARIANT	INCL. VAT	EXCL. VAT
1157109	SNAREGADE TABLETOP, CONNECTOR FITTING SET	19,95	16,69

TECHNICAL SPECIFICATIONS

PRODUCT TYPE
Connector

COLOUR
Black (RAL 9005)

CERTIFICATIONS
N / A

ENVIRONMENT
Indoor

GLOSS
Gloss 10-20

PACKAGING TYPE
Brown box

DIMENSIONS

H: 0,2 cm / 0,08"
W: 30 cm / 11,8"
D: 5,5 cm / 2,2"

MATERIALS
Powder coated steel

PACKAGING MEASUREMENTS (H x W x D)
1 cm x 35 cm x 8 cm / 0,42 x 13,8" x 3,1"

PRODUCTION PROCESS
CNC-cut steel plate.

WEIGHT
0,47 Kg / 1 lb

MATERIALS & MAINTENANCE
Please see page 486 for materials and care and maintenance instructions.

TEST
N / A

Knitting Chair

BY IB KOFOD-LARSEN

Handcrafted lounge chair made of solid natural or dark stained CNC-milled oak with form-pressed plywood seat and backrest and handsewn upholstery.

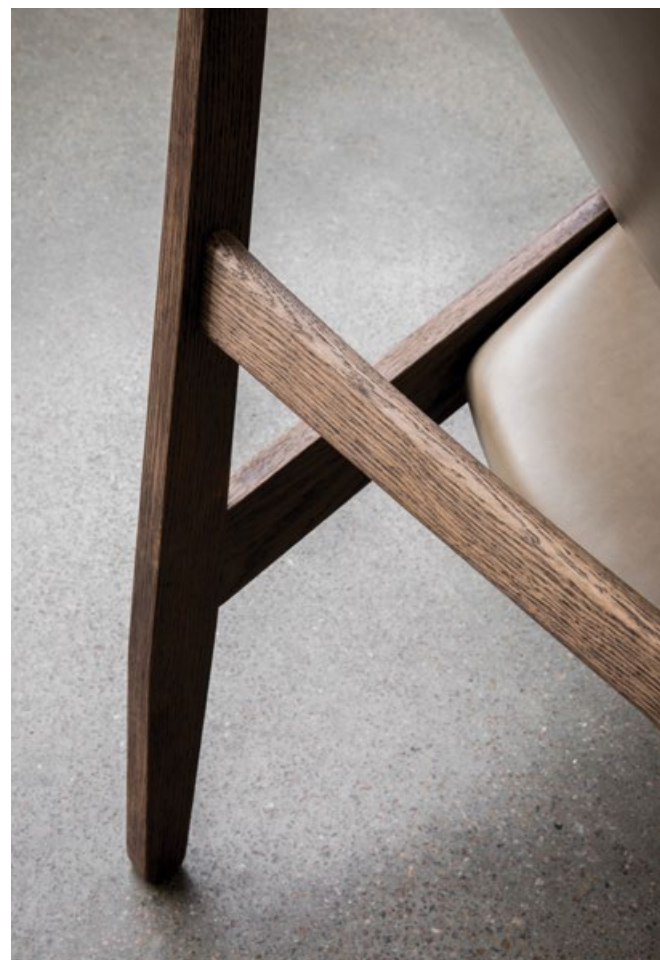

PRODUCT OPTIONS

SEAT

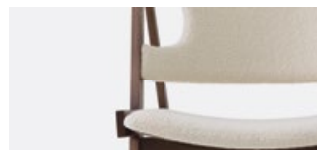

WITH UPHOLSTERY

OAK BASE



NATURAL OAK



DARK STAINED OAK

SPEC OPTIONS

Available in fabrics from our upholstery programme. Standard lead times apply. Custom upholstery available upon request. For further information please refer to MENU Upholstery Programme.

Knitting Chair, Dark Stained Oak / Dakar 0311, by Ib Kofod-Larsen

Knitting Chair

BY IB KOFOD-LARSEN

TECHNICAL SPECIFICATIONS

PRODUCT TYPE
Lounge chair

ENVIRONMENT
Indoor

DIMENSIONS
H: 90,6 cm / 35,7"
W: 71,3 cm / 28,1"
D: 66,9 cm / 26,3"
SH: 30 cm / 11,8"

PRODUCTION PROCESS
The solid oak frame is CNC-milled and treated with a wax-oiled finish. Seat and backrest are made from form-pressed plywood and upholstered in textile or leather. Assembly is done by hand.

COLOUR

Seat and backrest
Dependent upon selected upholstery

Base
Natural oak
Dark Stained oak

MATERIALS
Wax-oiled solid oak or dark stained oak, plywood, CAL117, available with CMHR and fabric.

GLOSS
N / A

WEIGHT
11 kg / 24,3 lb

TEST
N / A

CERTIFICATIONS
N / A

PACKAGING TYPE
Brown box

PACKAGING MEASUREMENTS (H x W x D)
95 cm x 80 cm x 75 cm / 37,4" x 31,5" x 29,5"

MATERIALS & MAINTENANCE
Please see page 486 for materials and care and maintenance instructions.

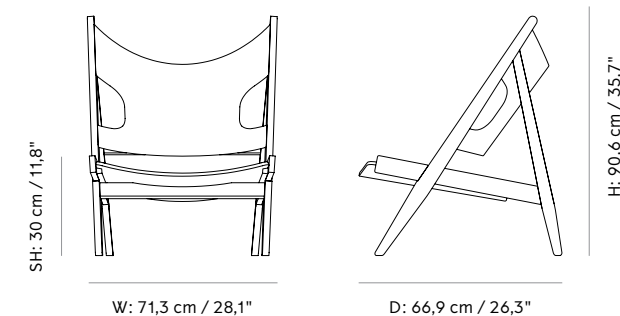

Knitting Chair

BY IB KOFOD-LARSEN

RECOMMENDED COMBINATIONS — PRICES IN EUR *Selected combinations 6–8 weeks delivery time.*

SKU	VARIANT	INCL. VAT	EXCL. VAT
Seat and backrest with upholstery — Oak base — Natural oak / Dark stained oak			
9680079	 KNIITING CHAIR, DARK STAINED OAK / COLLINE 118	2.509,95	2.100,33
9681969	 KNIITING CHAIR, NATURAL OAK / DUNES COGNAC 21000	3.199,95	2.677,72
9680739	 KNIITING CHAIR, DARK STAINED OAK / SAFIRE 0012	979,95	820,02
9680849	 KNIITING CHAIR, DARK STAINED OAK / DAKAR 0311	2.969,95	2.485,25

Additional charge of 10% for CMHR foam in accordance with UK requirement.
Option to upholster with customer's own fabric available upon request. For further information please see our upholstery programme on page 464.

Knitting Chair

BY IB KOFOD-LARSEN

SPEC OPTIONS — PRICES IN EUR *Selected combinations 6–8 weeks delivery time.*

SKU	VARIANT	INCL. VAT	EXCL. VAT
Textile — Seat and backrest with upholstery — Oak base — Natural oak / Dark stained oak			
9680001	PRICE CATEGORY 1 Remix 2, Kvadrat / Hot Madison, JAB / Gaja C2C, Gabriel / Pastel Poetry, JAB	2.279,95	1.907,86
9680002	PRICE CATEGORY 2 Hallingdal 65, Kvadrat / Savanna, Kvadrat / Colline, Kvadrat / Canvas, Kvadrat / Ritz, Nevotex / Fiord, Kvadrat / Steelcut 2, Kvadrat / Steelcut Trio 3, Kvadrat / Moss, Kvadrat / Clay, Kvadrat / Divina Melange, Kvadrat	2.509,95	2.100,33
9680003	PRICE CATEGORY 3 Vintage, Astrid / Safire, Kvadrat / Satoriale Collection: Grisaille, Dedar / Ponpon, Dedar	2.629,95	2.200,74
9680008	PRICE CATEGORY 4 (NEW) Satoriale Collection: Doppiopanama, Dedar / Deco, Dedar Texturologie Collection: Lupo, Dedar / Atlas, Dedar	2.739,95	2.292,79
Leather — Seat and backrest with upholstery — Oak base — Natural oak / Dark stained oak			
9680004	PRICE CATEGORY 1 Ultra, Sørensen Leather / Dakar, Nevotex	2.969,95	2.485,25
9680005	PRICE CATEGORY 2 Dunes, Sørensen Leather / Shade, Sørensen Leather / Nuance, Sørensen Leather	3.199,95	2.677,72
9680006	PRICE CATEGORY 3 Royal Nubuck, Sørensen Leather	3.649,95	3.054,28
9680007	PRICE CATEGORY 4 Elegance, Sørensen Leather	4.109,95	3.439,21

Additional charge of 10% for CMHR foam in accordance with UK requirement.
Option to upholster with customer's own fabric available upon request. For further information please see our upholstery programme on page 464.

Plinth

BY NORM ARCHITECTS

The Plinth is available in three different sizes and four marble colours: black, grey / brown, white and rose.

PRODUCT OPTIONS

MARBLE OPTIONS

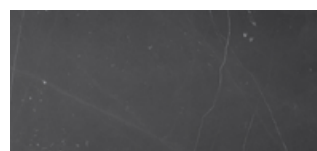

NERO MARQUINA MARBLE



GREY KENDZO MARBLE

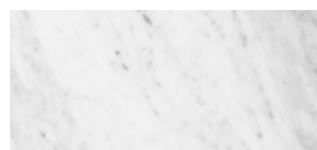

CARRARA MARBLE

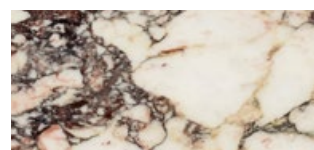

CALACATTA VIOLA MARBLE

Plinth Cubic, Grey Kendzo Marble, by Norm Architects
Cyclades Vase, Large, Sand, by Nick Ross



Plinth

BY NORM ARCHITECTS

TECHNICAL SPECIFICATIONS

PRODUCT TYPE
Coffee / Side table

ENVIRONMENT
Indoor

DIMENSIONS

Low
W: 100 cm / 39,4"
D: 60 cm / 23,6"
H: 27 cm / 10,6"

Cubic
W: 40 cm / 15,7"
D: 40 cm / 15,7"
H: 40 cm / 15,7"

Tall
W: 30 cm / 11,8"
D: 30 cm / 11,8"
H: 51 cm / 20,1"

PRODUCTION PROCESS

2cm thick marble plates are cut and edges are milled at 45-degree angles before all five plates are glued together in mitre joints. Corners are reinforced by reusing excess marble from the production. The bottom plate is made from MDF, where the adjustable glides are fastened.

COLOUR
Black marble
Grey / Brown marble
White marble
Rose marble

MATERIALS

Nero Marquina marble, Kendzo marble, Carrara marble, Calacatta Viola marble, MDF.

WEIGHT

Low
82 kg / 180,8 lb

Cubic
37,5 kg / 82,7 lb

Tall
32,5 kg / 71,7 lb

TEST
N / A

CERTIFICATIONS
TSCA title IV compliant

PACKAGING TYPE
Wooden box

PACKAGING MEASUREMENTS (H x W x D)

Low
45 cm x 110,5 cm x 70,5 cm / 17,7" x 43,5" x 27,8"

Cubic
54,5 cm x 56,5 cm x 56,5 cm / 21,5" x 22,2" x 22,2"

Tall
66 cm x 47 cm x 47 cm / 26" x 18,5" x 18,5"

MATERIALS & MAINTENANCE

Please see page 486 for materials and care and maintenance instructions.

LOW

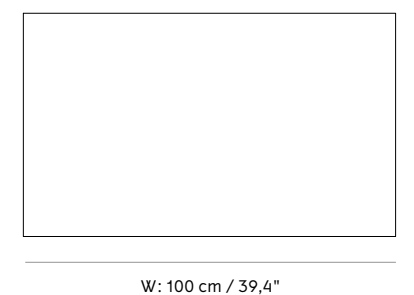

CUBIC

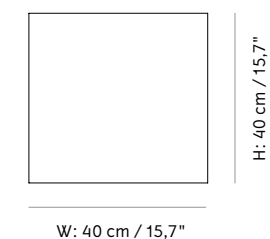



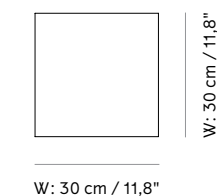









TALL



Plinth

BY NORM ARCHITECTS

STOCK OPTIONS — PRICES IN EUR *Selected combinations up to 2 weeks delivery time.*

SKU	VARIANT	INCL. VAT	EXCL. VAT
Plinth Low			
7000530	 PLINTH LOW, BLACK, NERO MARQUINA MARBLE	1.799,95	1.506,20
7000960	 PLINTH LOW, BROWN, GREY KENDZO MARBLE	1.799,95	1.506,20
7000630	 PLINTH LOW, WHITE, CARRARA MARBLE	1.799,95	1.506,20
7000319	 PLINTH LOW, ROSE, CALACATTA VIOLA MARBLE	2.029,95	1.698,66
Plinth Cubic			
7010530	 PLINTH CUBIC, BLACK, NERO MARQUINA MARBLE	999,95	836,76
7010960	 PLINTH CUBIC, BROWN, GREY KENDZO MARBLE	999,95	836,76
7010630	 PLINTH CUBIC, WHITE, CARRARA MARBLE	999,95	836,76
7010319	 PLINTH CUBIC, ROSE, CALACATTA VIOLA MARBLE	1.199,95	1.004,12
Plinth Tall			
7020530	 PLINTH TALL, BLACK, NERO MARQUINA MARBLE	999,95	836,76
7020960	 PLINTH TALL, BROWN, GREY KENDZO MARBLE	999,95	836,76
7020630	 PLINTH TALL, WHITE, CARRARA MARBLE	999,95	836,76
7020319	 PLINTH TALL, ROSE, CALACATTA VIOLA MARBLE	1.199,95	1.004,12

Plinth Tall, Calacatta Viola Marble, by Norm Architects
 Plinth Low, Calacatta Viola Marble, by Norm Architects
 Offset Sofa, 3-seater, Savanna 202, by Theresa Rand
 Column Table Lamp, by Norm Architects
 New Norm Dinnerware, Dark Glazed, by Norm Architects



Androgyne Side Table

BY DANIELLE SIGGERUD

Round side table with marquina marble or crystal rose marble top set on a laser-cut powder coated steel base. The base can be used with or without marble top.

PRODUCT OPTIONS

TABLETOP



CRYSTAL ROSE MARBLE



NERO MARQUINA MARBLE

POWDER COATED STEEL BASE



IVORY STEEL

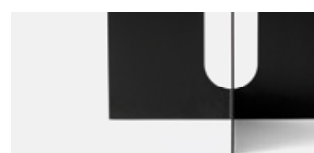

BLACK STEEL

Androgyne Side Table, Black Steel / Nero Marquina Marble, by Danielle Siggerud



Androgyne Side Table

BY DANIELLE SIGGERUD

STOCK OPTIONS — PRICES IN EUR *Selected combinations up to 2 weeks delivery time.*

SKU	VARIANT	INCL. VAT	EXCL. VAT
1180539	ANDROGYNE SIDE TABLE, BLACK STEEL	299,95	251,00
1180649	ANDROGYNE SIDE TABLE, IVORY STEEL	299,95	251,00
1181539	ANDROGYNE TABLETOP FOR SIDE TABLE, NERO MARQUINA MARBLE	179,95	150,58
1181649	ANDROGYNE TABLETOP FOR SIDE TABLE, CRYSTAL ROSE MARBLE	179,95	150,58

TECHNICAL SPECIFICATIONS

PRODUCT TYPE
Side table

ENVIRONMENT
Indoor

DIMENSIONS

Steel base
H: 43 cm / 16,9"
Ø: 40 cm / 15,75"

Steel base with marble top
H: 44,8 cm / 17,6"
Ø: 42 cm / 16,5"

PRODUCTION PROCESS
3mm steel sheet, CNC-cut and welded with powder coated finish. The table top are CNC milled and treated with a sealer.

COLOUR
Base
Black (RAL 9005)
Ivory (RAL 9002)

Marble top
Crystal rose
Nero marquina

MATERIALS
Crystal rose marble or Nero marquina marble.

GLOSS
Gloss 5-10

WEIGHT
Steel base: 9,7 kg / 21,4 lb
Marble top: 6,9 kg / 15,2 lb

TEST
N / A

CERTIFICATIONS
N / A

PACKAGING TYPE
Brown box

PACKAGING MEASUREMENTS (H x W x D)

Steel base
49 cm x 43 cm x 43 cm / 19,3" x 16,9" x 16,9"

Marble top
16 cm x 49,5 cm x 49,5 cm / 6,3" x 19,5" x 19,5"

MATERIALS & MAINTENANCE
Please see page 486 for materials and care and maintenance instructions.

STEEL BASE

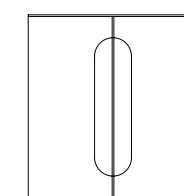
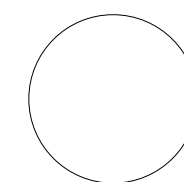

Ø: 40 cm / 15,75"

STEEL BASE WITH MARBLE TABLETOP

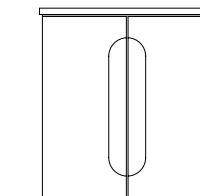
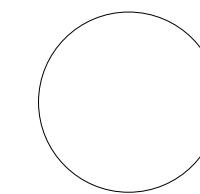

Ø: 40 cm / 15,75"

Androgyne Lounge Table

BY DANIELLE SIGGERUD

Kunis Breccia stone table with characteristic veins and mineral fragments in warm hues.

PRODUCT OPTIONS

TABLETOP

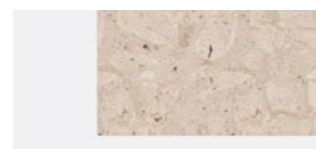

KUNIS BRECCIA STONE

BASE



KUNIS BRECCIA STONE

Eave Dining Sofa, Black Steel / Moss 022, by Norm Architects
Hashira Table Lamp, by Norm Architects
Androgyne Lounge Table, by Danielle Siggerud



Androgyne Lounge Table

BY DANIELLE SIGGERUD

RECOMMENDED COMBINATIONS — PRICES IN EUR *Selected combinations 6-8 weeks delivery time.*

SKU	VARIANT	INCL. VAT	EXCL. VAT
1184139	ANDROGYNE LOUNGE TABLE, SAND, KUNIS BRECCIA / SAND, KUNIS BRECCIA	2.549,95	2.133,80

TECHNICAL SPECIFICATIONS

PRODUCT TYPE
Lounge / Side table

COLOUR
Sand

CERTIFICATIONS
N / A

ENVIRONMENT
Indoor

MATERIALS
Kunis Breccia stone, solid brass and powder coated steel.

PACKAGING TYPE
Wood box

DIMENSIONS
H: 37,8 cm / 14,9"
W: 120 cm / 47,2"
D: 45 cm / 17,7"

WEIGHT
61 kg / 134,5 lb

PACKAGING MEASUREMENTS (H x W x D)
60 cm x 130 cm x 55 cm / 23,6" x 51,2" x 21,7"

PRODUCTION PROCESS
CNC-cut stone, hand-polished for a smooth surface finish.

TEST
N / A

MATERIALS & MAINTENANCE
Please see page 486 for materials and care and maintenance instructions.

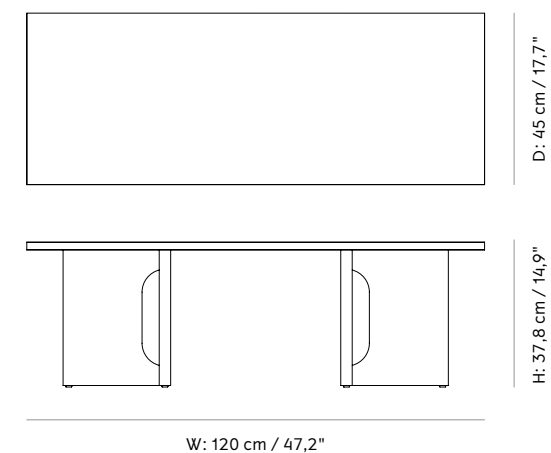

W: 120 cm / 47,2"

D: 45 cm / 17,7"

H: 37,8 cm / 14,9"

Androgyne Dining Table

BY DANIELLE SIGGERUD

Dining table with natural or dark stained solid oak base. Tabletop in matching colour (Ø120, Ø150) or kunis breccia stone (Ø120).

PRODUCT OPTIONS

TABLETOP

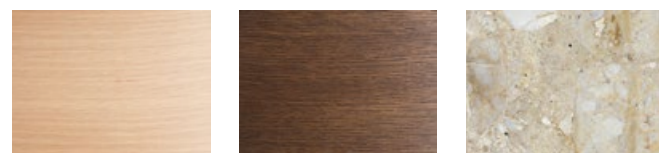

NATURAL OAK

DARK STAINED OAK

KUNIS BRECCIA STONE

OAK BASE



NATURAL OAK

DARK STAINED OAK

Androgyne Dining Table, Dark Stained Oak, by Danielle Siggerud
Harbour Dining Chair, Dark Stained Oak / Grisaille Col. 4 Marccasin, by Norm Architects



Androgyne Dining Table

BY DANIELLE SIGGERUD

TECHNICAL SPECIFICATIONS

PRODUCT TYPE

Dining table

ENVIRONMENT

Indoor

DIMENSIONS

Ø120

H: 73 cm / 28,8"

Ø: 120 cm / 47,2"

Ø150

H: 73 cm / 28,8"

Ø: 150 cm / 59,1"

PRODUCTION PROCESS

CNC cut solid wood base. Tabletop in veneered MDF, or CNC cut Kunis Breccia stone.

COLOUR

Base

Natural oak
Dark stained oak

Marble top

Sand, Kunis Breccia stone

GLOSS

N / A

MATERIALS

Natural and dark stained solid wood, natural and dark stained veneer, MDF, Kunis Breccia stone, powder coated steel, PA plast glides.

WEIGHT

Wood base
15 kg / 33,1 lb

Wood tabletop
Ø120: 25 kg / 55,1 lb
Ø150: 35 kg / 77,2 lb

Knuis breccia tabletop
Ø120: 90 kg / 198,4 lb

TEST

N / A

CERTIFICATIONS

TSCA title VI compliant

PACKAGING TYPE

Brown box
Brown box and wood box

PACKAGING MEASUREMENTS (H x W x D)

Wood base

7 cm x 71,5 cm x 99,9 cm / 2,8" x 28,1" x 39,3"

Wood tabletop

Ø120

5,5 cm x 121,5 cm x 121,5 cm / 2,2" x 47,8" x 47,8"

Ø150

5,5 cm x 151,5 cm x 151,5 cm / 2,2" x 59,6" x 59,6"

Knuis breccia tabletop

Ø120

10 cm x 130 cm x 130 cm / 4" x 51,2" x 51,2"

MATERIALS & MAINTENANCE

Please see page 486 for materials and care and maintenance instructions.

ANDROGYNE DINING TABLE, Ø120

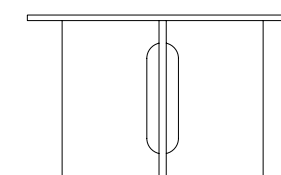
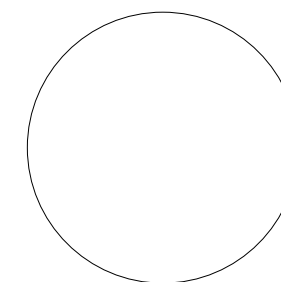

Ø: 120 cm / 47,2"

H: 73 cm / 28,8"

ANDROGYNE DINING TABLE, Ø150

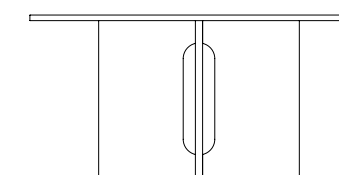
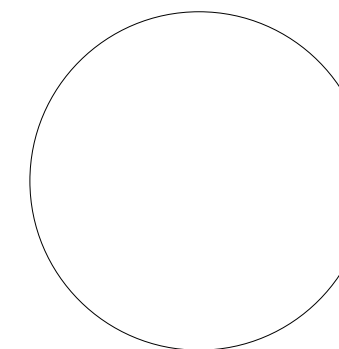

Ø: 150 cm / 59,1"

H: 73 cm / 28,8"

Androgyne Dining Table

BY DANIELLE SIGGERUD

STOCK OPTIONS — PRICES IN EUR *Selected combinations up to 2 weeks delivery time.*

SKU	VARIANT	INCL. VAT	EXCL. VAT
1183039	ANDROGYNE DINING TABLE, Ø120, NATURAL OAK / NATURAL OAK	3.079,95	2.577,30
1183849	ANDROGYNE DINING TABLE, Ø120, DARK STAINED OAK / DARK STAINED OAK	3.079,95	2.577,30
1183019	ANDROGYNE DINING TABLE, Ø120, NATURAL OAK / SAND STONE	3.695,00	3.091,98
1183819	ANDROGYNE DINING TABLE, Ø120, DARK STAINED OAK / SAND STONE	3.695,00	3.091,98

SPEC OPTIONS — PRICES IN EUR *Selected combinations 6–8 weeks delivery time.*

SKU	VARIANT	INCL. VAT	EXCL. VAT
1182039	ANDROGYNE DINING TABLE, Ø150, NATURAL OAK / NATURAL OAK	4.095,00	3.426,70
1182849	ANDROGYNE DINING TABLE, Ø150, DARK STAINED OAK / DARK STAINED OAK	4.095,00	3.426,70

Androgyne Dining Table, Natural Oak, by Danielle Siggerud
Co Chair w / Armrest, Black Steel / Natural Oak / Colline 118,
by Norm Architects & Els Van Hoorebeek



Turning Table

BY THERESA RAND

Oak or stained ash veneer tabletop with black chrome or brass base.

PRODUCT OPTIONS

VENEER TABLETOP

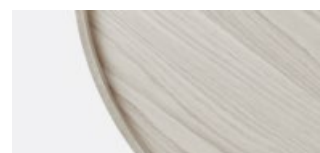

WHITE OAK

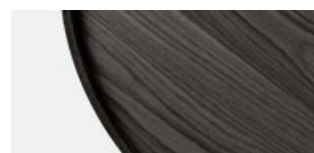

BLACK ASH

WOOD BASE



WHITE OAK / BLACK CHROME



BLACK ASH / BRASS

Turning Table, White Oak / Black Chrome / White Oak, by Theresa Rand
Gravel Rug, Ivory, by Nina Bruun



Turning Table

BY THERESA RAND

STOCK OPTIONS — PRICES IN EUR

Selected combinations up to 2 weeks delivery time.

SKU	VARIANT	INCL. VAT	EXCL. VAT
6900049	TURNING TABLE, WHITE OAK / BLACK CHROME	499,95	418,36
6900539	TURNING TABLE, BLACK ASH / BRASS	499,95	418,36

TECHNICAL SPECIFICATIONS

PRODUCT TYPE

Sofa table

ENVIRONMENT

Indoor

DIMENSIONS

H: 36 cm / 14,2"
Ø: 65 cm / 25,6"

PRODUCTION PROCESS

Bend veneer top, turned solid wood legs with a welded thread supporter.

COLOUR

White oak / black chrome
Black ash / brass

MATERIALS

Natural oak veneer, solid oak and black chromed steel or black stained ash veneer, solid ash and solid brass.

WEIGHT

9,4 kg / 20,7 lb

TEST

N / A

CERTIFICATIONS

TSCA title VI compliant

PACKAGING TYPE

Brown box

PACKAGING MEASUREMENTS (H x W x D)

68,5 cm x 68,5 cm x 15,5 cm / 27" x 27" x 6,1"

MATERIALS & MAINTENANCE

Please see page 486 for materials and care and maintenance instructions.

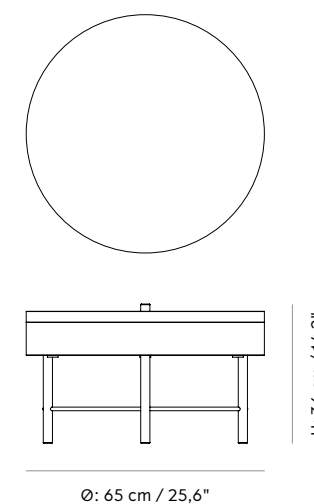

Align Daybed

BY ANITA JOHANSEN

Natural lacquered oak or black stained oak daybed with upholstered seat.

PRODUCT OPTIONS

SEAT



WITH TEXTILE



WITH LEATHER

OAK BASE



NATURAL LACQUERED OAK



BLACK ASH

Align Daybed, Natural Oak / Hallingdal 65 110 Light Grey, by Anita Johansen
Warren Wall Lamp, by Søren Rose Studio





Additional charge of 10% for CMHR foam in accordance with UK requirement.

Align Daybed

BY ANITA JOHANSEN

RECOMMENDED COMBINATIONS — PRICES IN EUR *Selected combinations 6–8 weeks delivery time.*

SKU	VARIANT	INCL. VAT	EXCL. VAT
Oak base — Seat with upholstery — Black oak / Natural oak			
1010539	 ALIGN DAYBED, BLACK OAK / DUNES ANTHRAZITE 21003	3.079,95	2.577,30
1010039	 ALIGN DAYBED, NATURAL OAK / HALLINGDAL 65-110	2.529,95	2.117,06

TECHNICAL SPECIFICATIONS

PRODUCT TYPE
Daybed

ENVIRONMENT
Indoor

DIMENSIONS
H: 40 cm / 15,7"
L: 180 cm / 70,8"
D: 80 cm / 31,5"

PRODUCTION PROCESS
Turned solid wood base, plywood construction and upholstered seat.

COLOUR

Base
Black stained oak
Natural oak

Seat
Dependent upon selected upholstery.

MATERIALS

Solid oak, plywood, CAL117 foam and upholstery.

WEIGHT

13 kg / 28,7 lb

TEST
N / A

CERTIFICATIONS
TSCA title VI compliant

PACKAGING TYPE
Brown box

PACKAGING MEASUREMENTS (H x W x D)
184 cm x 84 cm x 11,5 cm / 72,4" x 33,1" x 4,5"

MATERIALS & MAINTENANCE
Please see page 486 for materials and care and maintenance instructions.

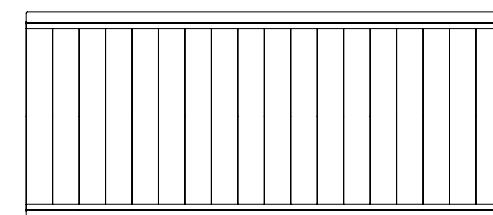

D: 80 cm / 31,5"

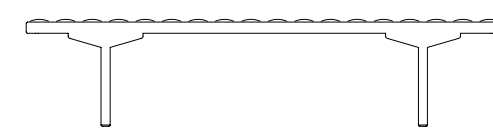

H: 40 cm / 15,7"

L: 180 cm / 70,8"

Eave Modular Sofa

BY NORM ARCHITECTS

Module-based, foam-filled sofa with corner, open and pouf sections in textile upholstery and set on a wooden spring frame.



PRODUCT OPTIONS

CORNER



OPEN SECTION



POUF



SPEC OPTIONS

Available in fabrics from our upholstery programme. Standard lead times apply. Custom upholstery available upon request. For further information please refer to MENU Upholstery Programme.

Eave Modular Sofa, Safire 0012, by Norm Architects
 Hashira Pendant, Cluster, Large, by Norm Architects
 Hashira Floor Lamp, by Norm Architects
 Knitting Chair, Dark Stained Oak / Dakar 0311, by Ib Kofod-Larsen
 Tearoom Lounge Chair, Deco Avorio T14035 001, by Nick Ross
 Androgyne Side Table, Ivory steel / Crystal beige rose, by Danielle Siggerud
 Plinth Low, Grey Kendzo Marble, by Norm Architects
 Gravel Rug, Ivory, by Nina Bruun
 Duca Candleholders, Polished Brass, by Krøyer-Sætter-Lassen

Eave Modular Sofa

BY NORM ARCHITECTS

TECHNICAL SPECIFICATIONS

PRODUCT TYPE
Sofa

ENVIRONMENT
Indoor

DIMENSIONS

Corner, 86
 H: 70,5 cm / 27,8"
 W: 86 cm / 33,9"
 D: 86 cm / 33,9"
 SH: 40,5 cm / 15,9"

Corner, 96
 H: 70,5 cm / 27,8"
 W: 96 cm / 37,8"
 D: 96 cm / 37,8"
 SH: 40,5 cm / 15,9"

Open section, 86
 H: 70,5 cm / 27,8"
 W: 75 cm / 29,5"
 D: 86 cm / 33,9"
 SH: 40,5 cm / 15,9"

Open section, 96
 H: 70,5 cm / 27,8"
 W: 75 cm / 29,5"
 D: 96 cm / 37,8"
 SH: 40,5 cm / 15,9"

Pouf, 75
 H: 40,5 cm / 15,9"
 W: 75 cm / 29,5"
 D: 75 cm / 29,5"
 SH: 40,5 cm / 15,9"

Pouf, 86
 H: 40,5 cm / 15,9"
 W: 86 cm / 33,9"
 D: 86 cm / 33,9"
 SH: 40,5 cm / 15,9"

Pouf, 96
 H: 40,5 cm / 15,9"
 W: 96 cm / 37,8"
 D: 96 cm / 37,8"
 SH: 40,5 cm / 15,9"

PRODUCTION PROCESS

Each module is constructed with a structural frame made from pine, plywood and MDF. Seat, backrest and armrests consist of a double foam layer with no-sag springs.

CORNER

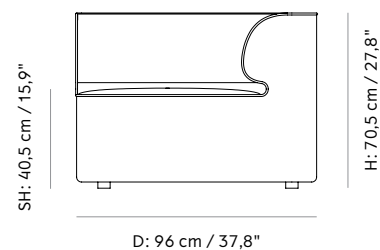
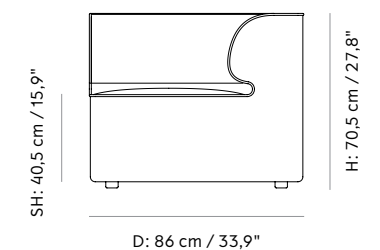

COLOUR
 Dependent upon selected upholstery.
 Black glides (RAL 9005)

GLOSS
 N / A

MATERIALS

Seat
 Pine, plywood, MDF, steel (spring), HR Foam and upholstery

Glides and connector
 Plastic, steel

WEIGHT

Corner, 86: 32 kg / 70,5 lb
 Corner, 96: 38 kg / 83,8 lb
 Open Section, 86: 24 kg / 52,9 lb
 Open Section, 96: 29 kg / 63,9 lb
 Pouf, 75: 19 kg / 41,9 lb
 Pouf, 86: 22 kg / 48,5 lb
 Pouf, 96: 35 kg / 77,2 lb

CORNER VARIANTS

Corner modules come in left and right variants according to fabric weave direction. Please ensure you select the correct one for your needs.

TEST
 N / A

OPEN SECTION

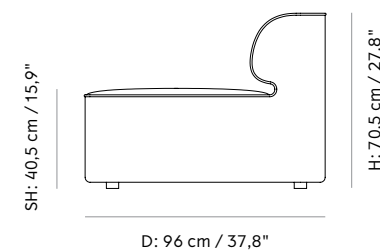
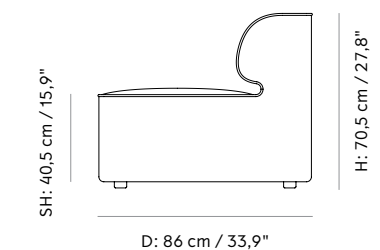

CERTIFICATIONS
 TSCA title VI compliant

PACKAGING TYPE
 Brown box

PACKAGING MEASUREMENTS (H x W x D)

Corner, 86
 73 cm x 88 cm x 88 cm / 27,7" x 34,6" x 34,6"

Corner, 96
 73 cm x 98 cm x 102 cm / 28,7" x 38,6" x 40,2"

Open section, 86
 73 cm x 88 cm x 77 cm / 27,7" x 34,6" x 30,3"

Open section, 96
 73 cm x 77 cm x 98 cm / 27,7" x 30,3" x 38,6"

Pouf, 75
 34 cm x 77 cm x 77 cm / 17" x 30,3" x 30,3"

Pouf, 86
 73 cm x 87 cm x 87 cm / 28,7" x 34,3" x 34,3"

Pouf, 96
 41 cm x 96 cm x 96 cm / 16,1" x 37,8" x 37,8"

MATERIALS & MAINTENANCE

Please see page 486 for materials and care and maintenance instructions.



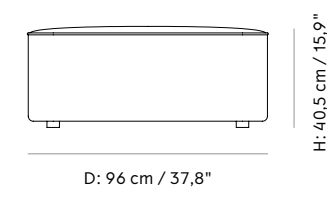
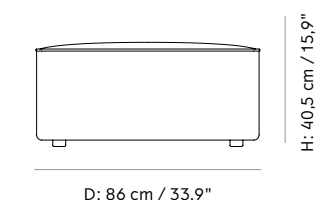
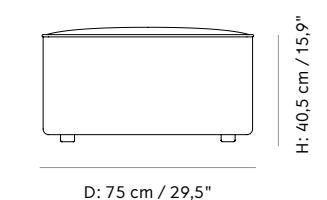





POUF



Eave Modular Sofa, 86

BY NORM ARCHITECTS

RECOMMENDED COMBINATIONS — PRICES IN EUR *Selected combinations 6–8 weeks delivery time.*

SKU	VARIANT	INCL. VAT	EXCL. VAT
Corner, 86 — Module with upholstery			
9961140	 EAVE MODULAR 86, CORNER / HOT MADISON RELOADED CH1249/233 (NEW)	1.799,95	1.506,20
9961160	 EAVE MODULAR 86, CORNER / MOSS 018 (NEW)	2.259,95	1.891,13
9961850	 EAVE MODULAR 86, CORNER / MOSS 022 (NEW)	2.259,95	1.891,13
Open section, 86 — Module with upholstery			
9962140	 EAVE MODULAR 86, OPEN SECTION / HOT MADISON RELOADED CH1249/233 (NEW)	1.349,95	1.129,64
9962160	 EAVE MODULAR 86, OPEN SECTION / MOSS 018 (NEW)	1.799,95	1.506,20
9962850	 EAVE MODULAR 86, OPEN SECTION / MOSS 022 (NEW)	1.799,95	1.506,20
Pouf, 86 — Seat with upholstery			
9963140	 EAVE MODULAR 86, POUF / HOT MADISON RELOADED CH1249/233 (NEW)	999,95	836,76
9963160	 EAVE MODULAR 86, POUF / MOSS 018 (NEW)	1.299,95	1.087,80
9963850	 EAVE MODULAR 86, POUF / MOSS 022 (NEW)	1.299,95	1.087,80

Additional charge of 10% for CMHR foam in accordance with UK requirement.
Option to upholster with customer's own fabric available upon request. For further information please see our upholstery programme on page 464.

Eave Modular Sofa, 86

BY NORM ARCHITECTS







SPEC OPTIONS — PRICES IN EUR *Selected combinations 6–8 weeks delivery time.*

SKU	VARIANT	INCL. VAT	EXCL. VAT
Textile — Corner, 86 — Module with upholstery			
9961101	PRICE CATEGORY 1 (NEW) Maple, Kvadrat / Remix 2, Kvadrat / City Velvet, JAB / Hot Madison Reloaded, JAB / Gaja C2C, Gabriel / Champion, Kvadrat	1.799,95	1.506,20
9961102	PRICE CATEGORY 2 (NEW) Hallingdal 65, Kvadrat / Savanna, Kvadrat / Colline, Kvadrat / Canvas, Kvadrat / Ritz, Nevotex / Fiord, Kvadrat / Steelcut 2, Kvadrat / Steelcut Trio 3, Kvadrat / Moss, Kvadrat / Clay, Kvadrat / Divina Melange, Kvadrat	2.259,95	1.891,13
9961103	PRICE CATEGORY 3 (NEW) Vintage, Astrid / Safire, Kvadrat / Satoriale Collection: Grisaille, Dedar / Ponpon, Dedar	2.529,95	2.117,06
9961108	PRICE CATEGORY 4 (NEW) Satoriale Collection: Doppiopanama, Dedar / Deco, Dedar Texturologie Collection: Lupo, Dedar / Atlas, Dedar	2.799,95	2.343,00
Textile — Open section, 86 — Module with upholstery			
9962101	PRICE CATEGORY 1 (NEW) Maple, Kvadrat / Remix 2, Kvadrat / City Velvet, JAB / Hot Madison Reloaded, JAB / Gaja C2C, Gabriel / Champion, Kvadrat	1.349,95	1.129,64
9962102	PRICE CATEGORY 2 (NEW) Hallingdal 65, Kvadrat / Savanna, Kvadrat / Colline, Kvadrat / Canvas, Kvadrat / Ritz, Nevotex / Fiord, Kvadrat / Steelcut 2, Kvadrat / Steelcut Trio 3, Kvadrat / Moss, Kvadrat / Clay, Kvadrat / Divina Melange, Kvadrat	1.799,95	1.506,20
9962103	PRICE CATEGORY 3 (NEW) Vintage, Astrid / Safire, Kvadrat / Satoriale Collection: Grisaille, Dedar / Ponpon, Dedar	1.999,95	1.673,56
9962108	PRICE CATEGORY 4 (NEW) Satoriale Collection: Doppiopanama, Dedar / Deco, Dedar Texturologie Collection: Lupo, Dedar / Atlas, Dedar	2.099,95	1.757,24
Textile — Pouf, 86 — Module with upholstery			
9963101	PRICE CATEGORY 1 (NEW) Maple, Kvadrat / Remix 2, Kvadrat / City Velvet, JAB / Hot Madison Reloaded, JAB / Gaja C2C, Gabriel / Champion, Kvadrat	999,95	836,76
9963102	PRICE CATEGORY 2 (NEW) Hallingdal 65, Kvadrat / Savanna, Kvadrat / Colline, Kvadrat / Canvas, Kvadrat / Ritz, Nevotex / Fiord, Kvadrat / Steelcut 2, Kvadrat / Steelcut Trio 3, Kvadrat / Moss, Kvadrat / Clay, Kvadrat / Divina Melange, Kvadrat	1.299,95	1.087,80
9963103	PRICE CATEGORY 3 (NEW) Vintage, Astrid / Safire, Kvadrat / Satoriale Collection: Grisaille, Dedar / Ponpon, Dedar	1.449,95	1.213,32
9963108	PRICE CATEGORY 4 (NEW) Satoriale Collection: Doppiopanama, Dedar / Deco, Dedar Texturologie Collection: Lupo, Dedar / Atlas, Dedar	1.599,95	1.338,84

Eave Modular Pouf, 75

BY NORM ARCHITECTS

RECOMMENDED COMBINATIONS — PRICES IN EUR *Selected combinations 6–8 weeks delivery time.*

SKU	VARIANT	INCL. VAT	EXCL. VAT
Pouf, 75 — Module with upholstery			
9964140	 EAVE MODULAR 75, POUF / HOT MADISON RELOADED CH1249/233 (NEW)	899,95	753,08
9964160	 EAVE MODULAR 75, POUF / MOSS 018 (NEW)	1.199,95	1.004,12
9964850	 EAVE MODULAR 75, POUF / MOSS 022 (NEW)	1.199,95	1.004,12
400268	 EAVE MODULAR 75, POUF / KARAKORUM 003 (NEW)	1.409,95	1.179,85
400269	 EAVE MODULAR 75, POUF / NOUVELLES VAGUES 002 (NEW)	1.479,95	1.238,42
400270	 EAVE MODULAR 75, POUF / TIGER MOUNTAIN T18015/003 (NEW)	1.595,00	1.334,70

Additional charge of 10% for CMHR foam in accordance with UK requirement.
Option to upholster with customer's own fabric available upon request. For further information please see our upholstery programme on page 464.

Eave Modular Pouf, 75

BY NORM ARCHITECTS

SPEC OPTIONS — PRICES IN EUR *Selected combinations 6–8 weeks delivery time.*











SKU	VARIANT	INCL. VAT	EXCL. VAT
Textile — Pouf, 75 — Module with upholstery			
9964101	PRICE CATEGORY 1 (NEW) Maple, Kvadrat / Remix 2, Kvadrat / City Velvet, JAB / Hot Madison Reloaded, JAB / Gaja C2C, Gabriel / Champion, Kvadrat	899,95	753,08
9964102	PRICE CATEGORY 2 (NEW) Hallingdal 65, Kvadrat / Savanna, Kvadrat / Colline, Kvadrat / Canvas, Kvadrat / Ritz, Nevotex / Fiord, Kvadrat / Steelcut 2, Kvadrat / Steelcut Trio 3, Kvadrat / Moss, Kvadrat / Clay, Kvadrat / Divina Melange, Kvadrat	1.199,95	1.004,12
9964103	PRICE CATEGORY 3 (NEW) Vintage, Astrid / Safire, Kvadrat / Satoriale Collection: Grisaille, Dedar / Ponpon, Dedar	1.299,95	1.087,80
9964108	PRICE CATEGORY 4 (NEW) Satoriale Collection: Doppiopanama, Dedar / Deco, Dedar Texturologie Collection: Lupo, Dedar / Atlas, Dedar	1.399,95	1.171,48

Additional charge of 10% for CMHR foam in accordance with UK requirement.
Option to upholster with customer's own fabric available upon request. For further information please see our upholstery programme on page 464.

Eave Modular Sofa, 96

BY NORM ARCHITECTS

RECOMMENDED COMBINATIONS — PRICES IN EUR *Selected combinations 6–8 weeks delivery time.*

SKU	VARIANT	INCL. VAT	EXCL. VAT
Corner, 96 — Module with upholstery			
9951469	 EAVE MODULAR 96, CORNER / CITY VELVET CA7832 / 031	1.799,95	1.506,20
9951739	 EAVE MODULAR 96, CORNER / SAFIRE 012	2.609,95	2.184,01
9951029	 EAVE MODULAR 96, CORNER / SAVANNA 202	2.339,95	1.958,07
Open section, 96 — Module with upholstery			
9952469	 EAVE MODULAR 96, OPEN SECTION / CITY VELVET CA7832 / 031	1.399,95	1.171,48
9952739	 EAVE MODULAR 96, OPEN SECTION / SAFIRE 012	2.029,95	1.698,66
9952029	 EAVE MODULAR 96, OPEN SECTION / SAVANNA 202	1.819,95	1.522,93
Pouf, 96 — Module with upholstery			
9953469	 EAVE MODULAR 96, POUF / CITY VELVET CA7832 / 031	999,95	836,76
9953739	 EAVE MODULAR 96, POUF / SAFIRE 012	1.449,95	1.213,32
9953029	 EAVE MODULAR 96, POUF / SAVANNA 202	1.299,95	1.087,80
400108	 EAVE MODULAR 86, POUF / SCHWARZWALD 001 (NEW)	2.495,00	2.087,82
400267	 EAVE MODULAR 86, POUF / NOUVELLES VAGUES 003 (NEW)	2.595,00	2.171,50

Additional charge of 10% for CMHR foam in accordance with UK requirement.
Option to upholster with customer's own fabric available upon request. For further information please see our upholstery programme on page 464.

Eave Modular Sofa, 96

BY NORM ARCHITECTS

SPEC OPTIONS — PRICES IN EUR *Selected combinations 6–8 weeks delivery time.*

SKU	VARIANT	INCL. VAT	EXCL. VAT
Textile — Corner, 96 — Module with upholstery			
9951101	PRICE CATEGORY 1 Maple, Kvadrat / Remix 2, Kvadrat / City Velvet, JAB / Hot Madison Reloaded, JAB / Gaja C2C, Gabriel / Champion, Kvadrat	1.799,95	1.506,20
9951102	PRICE CATEGORY 2 Hallingdal 65, Kvadrat / Savanna, Kvadrat / Colline, Kvadrat / Canvas, Kvadrat / Ritz, Nevotex / Fiord, Kvadrat / Steelcut 2, Kvadrat / Steelcut Trio 3, Kvadrat / Moss, Kvadrat / Clay, Kvadrat / Divina Melange, Kvadrat	2.339,95	1.958,07
9951103	PRICE CATEGORY 3 Vintage, Astrid / Safire, Kvadrat / Satoriale Collection: Grisaille, Dedar / Ponpon, Dedar	2.609,95	2.184,01
9951108	PRICE CATEGORY 4 (NEW) Satoriale Collection: Doppiopanama, Dedar / Deco, Dedar Texturologie Collection: Lupo, Dedar / Atlas, Dedar	2.789,95	2.334,63
Textile — Open section, 96 — Module with upholstery			
9952101	PRICE CATEGORY 1 Maple, Kvadrat / Remix 2, Kvadrat / City Velvet, JAB / Hot Madison Reloaded, JAB / Gaja C2C, Gabriel / Champion, Kvadrat	1.399,95	1.171,48
9952102	PRICE CATEGORY 2 Hallingdal 65, Kvadrat / Savanna, Kvadrat / Colline, Kvadrat / Canvas, Kvadrat / Ritz, Nevotex / Fiord, Kvadrat / Steelcut 2, Kvadrat / Steelcut Trio 3, Kvadrat / Moss, Kvadrat / Clay, Kvadrat / Divina Melange, Kvadrat	1.819,95	1.522,93
9952103	PRICE CATEGORY 3 Vintage, Astrid / Safire, Kvadrat / Satoriale Collection: Grisaille, Dedar / Ponpon, Dedar	2.029,95	1.698,66
9952108	PRICE CATEGORY 4 (NEW) Satoriale Collection: Doppiopanama, Dedar / Deco, Dedar Texturologie Collection: Lupo, Dedar / Atlas, Dedar	2.169,95	1.815,81
Textile — Pouf, 96 — Module with upholstery			
9953101	PRICE CATEGORY 1 Maple, Kvadrat / Remix 2, Kvadrat / City Velvet, JAB / Hot Madison Reloaded, JAB / Gaja C2C, Gabriel / Champion, Kvadrat	1.595,00	1.334,70
9953102	PRICE CATEGORY 2 Hallingdal 65, Kvadrat / Savanna, Kvadrat / Colline, Kvadrat / Canvas, Kvadrat / Ritz, Nevotex / Fiord, Kvadrat / Steelcut 2, Kvadrat / Steelcut Trio 3, Kvadrat / Moss, Kvadrat / Clay, Kvadrat / Divina Melange, Kvadrat	9.695,00	7.756,00
9953103	PRICE CATEGORY 3 Vintage, Astrid / Safire, Kvadrat / Satoriale Collection: Grisaille, Dedar / Ponpon, Dedar	10.895,00	8.716,00
9953108	PRICE CATEGORY 4 (NEW) Satoriale Collection: Doppiopanama, Dedar / Deco, Dedar Texturologie Collection: Lupo, Dedar / Atlas, Dedar	11.595,00	9.276,00

Eave Dining Sofa

BY NORM ARCHITECTS

Banquette-style sofa foam-padded modules in fabric upholstery and set on wooden frame. As no two spaces are the same, we also offer bespoke solutions that accommodate individual requirements for length.

Eave Dining Sofa, Black Steel / Moss 022, by Norm Architects
Eave Dining Sofa, Black Steel / Hot Madison Reloaded CH1249/233, by Norm Architects



PRODUCT OPTIONS

165



200

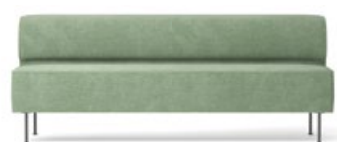

280



SPEC OPTIONS

Available in fabrics from our upholstery programme. Standard lead times apply. Custom upholstery available upon request. For further information please refer to MENU Upholstery Programme.

Eave Dining Sofa

BY NORM ARCHITECTS

TECHNICAL SPECIFICATIONS

PRODUCT TYPE
Sofa

ENVIRONMENT
Indoor

DIMENSIONS

165
H: 75 cm / 29,5"
W: 165 cm / 65"
D: 59 cm / 23,2"
SH: 48 cm / 18,9"

200
H: 75 cm / 29,5"
SH: 48 cm / 18,9"
W: 200 cm / 78,7"
D: 59 cm / 23,2"

280
H: 75 cm / 29,5"
SH: 48 cm / 18,9"
W: 280 cm / 110,2"
D: 59 cm / 23,2"

PRODUCTION PROCESS

Modules are constructed with a frame made from pine, plywood and MDF. Seat, backrest and armrests consist of a double layer of foam and no-sag springs. Legs are made from powder coated steel rod, welded on a mounting bracket in steel.

COLOUR

Legs
Black (RAL 9005)

Seat
Dependent upon selected upholstery

MATERIALS

Seat
Pine, plywood, MDF, steel (spring), HR Foam and upholstery

Legs
Steel

WEIGHT

165: 41 kg / 90,4 lb
200: 49 kg / 108 lb
280: 67 kg / 147,7 lb

Item weight depends on modules selected.

TEST
N / A

CERTIFICATIONS
TSCA title VI compliant

PACKAGING TYPE
Brown box

PACKAGING MEASUREMENTS (H x W x D)

165
78 cm x 168 cm x 62 cm / 30,7" x 66,1" x 24,4"

200
78 cm x 203 cm x 62 cm / 30,7" x 79,9" x 24,4"

280
78 cm x 283 cm x 62 cm / 30,7" x 111,4" x 24,4"

Packaging measurements depend on modules selected.

MATERIALS & MAINTENANCE
Please see page 486 for materials and care and maintenance instructions.

EAVE DINING SOFA, 165

EAVE DINING SOFA, 200

EAVE DINING SOFA, 280

SH: 48 cm / 18,9"

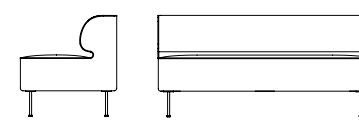

D: 59 cm / 23,2"

W: 165 cm / 65"

H: 75 cm / 29,5"

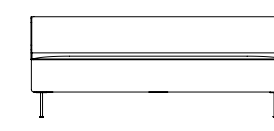

W: 200 cm / 78,7"

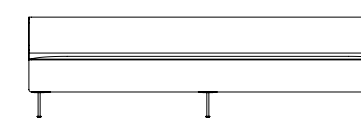

W: 280 cm / 110,2"

Eave Dining Sofa

BY NORM ARCHITECTS

RECOMMENDED COMBINATIONS — PRICES IN EUR *Selected combinations 6–8 weeks delivery time.*

SKU	VARIANT	INCL. VAT	EXCL. VAT
Eave Dining, 165 — Module with upholstery			
9970140	 EAVE DINING 165, BLACK STEEL / HOT MADISON RELOADED CH1249 / 233 (NEW)	2.149,95	1.799,08
9970160	 EAVE DINING 165, BLACK STEEL / MOSS 018 (NEW)	2.799,95	2.343,00
9970850	 EAVE DINING 165, BLACK STEEL / MOSS 022 (NEW)	2.799,95	2.343,00
Eave Dining, 200 — Module with upholstery			
9971140	 EAVE DINING 200, BLACK STEEL / HOT MADISON RELOADED CH1249 / 233 (NEW)	2.399,95	2.008,28
9971160	 EAVE DINING 200, BLACK STEEL / MOSS 018 (NEW)	3.129,95	2.619,14
9971850	 EAVE DINING 200, BLACK STEEL / MOSS 022 (NEW)	3.129,95	2.619,14
Eave Dining, 280 — Module with upholstery			
9972140	 EAVE DINING 280, BLACK STEEL / HOT MADISON RELOADED CH1249 / 233 (NEW)	2.949,95	2.468,52
9972160	 EAVE DINING, BLACK STEEL / MOSS 018 (NEW)	3.799,95	3.179,80
9972850	 EAVE DINING, BLACK STEEL / MOSS 022 (NEW)	3.799,95	3.179,80

Additional charge of 10% for CMHR foam in accordance with UK requirement.
Option to upholster with customer's own fabric available upon request. For further information please see our upholstery programme on page 464.

Eave Dining Sofa

BY NORM ARCHITECTS

SPEC OPTIONS — PRICES IN EUR *Selected combinations 6–8 weeks delivery time.*

SKU	VARIANT	INCL. VAT	EXCL. VAT
Textile — Eave Dining, 165 — Module with upholstery			
9970001	PRICE CATEGORY 1 (NEW) Maple, Kvadrat / Remix 2, Kvadrat / City Velvet, JAB / Hot Madison Reloaded, JAB / Gaja C2C, Gabriel / Champion, Kvadrat	2.149,95	1.799,08
9970002	PRICE CATEGORY 2 (NEW) Hallingdal 65, Kvadrat / Savanna, Kvadrat / Colline, Kvadrat / Canvas, Kvadrat / Ritz, Nevotex / Fiord, Kvadrat / Steelcut 2, Kvadrat / Steelcut Trio 3, Kvadrat / Moss, Kvadrat / Clay, Kvadrat / Divina Melange, Kvadrat	2.799,95	2.343,00
9970003	PRICE CATEGORY 3 (NEW) Vintage, Astrid / Safire, Kvadrat / Satoriale Collection: Grisaille, Dedar / Ponpon, Dedar	3.099,95	2.594,04
9970008	PRICE CATEGORY 4 (NEW) Satoriale Collection: Doppiopanama, Dedar / Deco, Dedar Texturologie Collection: Lupo, Dedar / Atlas, Dedar	3.299,95	2.761,40
Textile — Eave Dining, 200 — Module with upholstery			
9971001	PRICE CATEGORY 1 (NEW) Maple, Kvadrat / Remix 2, Kvadrat / City Velvet, JAB / Hot Madison Reloaded, JAB / Gaja C2C, Gabriel / Champion, Kvadrat	2.399,95	2.008,28
9971002	PRICE CATEGORY 2 (NEW) Hallingdal 65, Kvadrat / Savanna, Kvadrat / Colline, Kvadrat / Canvas, Kvadrat / Ritz, Nevotex / Fiord, Kvadrat / Steelcut 2, Kvadrat / Steelcut Trio 3, Kvadrat / Moss, Kvadrat / Clay, Kvadrat / Divina Melange, Kvadrat	3.129,95	2.619,14
9971003	PRICE CATEGORY 3 (NEW) Vintage, Astrid / Safire, Kvadrat / Satoriale Collection: Grisaille, Dedar / Ponpon, Dedar	3.479,95	2.912,02
9971008	PRICE CATEGORY 4 (NEW) Satoriale Collection: Doppiopanama, Dedar / Deco, Dedar Texturologie Collection: Lupo, Dedar / Atlas, Dedar	3.729,95	3.121,22
Textile — Eave Dining, 280 — Seat with upholstery			
9972001	PRICE CATEGORY 1 (NEW) Maple, Kvadrat / Remix 2, Kvadrat / City Velvet, JAB / Hot Madison Reloaded, JAB / Gaja C2C, Gabriel / Champion, Kvadrat	2.949,95	2.468,52
9972002	PRICE CATEGORY 2 (NEW) Hallingdal 65, Kvadrat / Savanna, Kvadrat / Colline, Kvadrat / Canvas, Kvadrat / Ritz, Nevotex / Fiord, Kvadrat / Steelcut 2, Kvadrat / Steelcut Trio 3, Kvadrat / Moss, Kvadrat / Clay, Kvadrat / Divina Melange, Kvadrat	3.799,95	3.179,80
9972003	PRICE CATEGORY 3 (NEW) Vintage, Astrid / Safire, Kvadrat / Satoriale Collection: Grisaille, Dedar / Ponpon, Dedar	4.279,95	3.581,46
9972008	PRICE CATEGORY 4 (NEW) Satoriale Collection: Doppiopanama, Dedar / Deco, Dedar Texturologie Collection: Lupo, Dedar / Atlas, Dedar	4.549,95	3.807,40

Godot Sofa

BY ISKOS-BERLIN

One-, two- and three-seater upholstered sofas with powder coated steel legs.

PRODUCT OPTIONS

1 SEATER



2 SEATER



3 SEATER



SPEC OPTIONS

Available in fabrics from our upholstery programme. Standard lead times apply. Custom upholstery available upon request. For further information please refer to MENU Upholstery Programme.

Godot Sofa, 1-seater, Hallingdal 130, by Iskos-Berlin



Godot Sofa

BY ISKOS-BERLIN

PRICES IN EUR

SKU	VARIANT	INC. VAT	EX. VAT
Godot, Legs to seaters, 4-pack			
9760539	GODOT, LEG, 20 CM, BLACK, 4-PACK	49,95	41,80

TECHNICAL SPECIFICATIONS

PRODUCT TYPE
Seater

ENVIRONMENT
Indoor

DIMENSIONS

1 Seater
H: 70 cm / 27,6"
SH: 40 cm / 15,7"
W: 82,5 cm / 32,5"
D: 82,5 cm / 32,5"

2 Seater
H: 70 cm / 27,6"
SH: 40 cm / 15,7"
W: 162 cm / 63,8"
D: 82,5 cm / 32,5"

3 Seater
H: 70 cm / 27,6"
SH: 40 cm / 15,7"
W: 222 cm / 87,4"
D: 82,5 cm / 32,5"

PRODUCTION PROCESS
The seaters are constructed with a structural frame made from pine, plywood and MDF. Seat, backrest and armrests are made of cut foam parts. The legs is powder coated steel rod, welded on a mounting bracket in steel.

COLOUR

Legs
Black

Seat
Dependent upon selected upholstery

MATERIALS

Seat
Pine, plywood, MDF, steel (spring), CAL117 foam and upholstery

Legs
Steel

WEIGHT

1 Seater: 46 kg / 101,4 lb
2 Seater: 77 kg / 169,8 lb
3 Seater: 99 kg / 218,3 lb

TEST
EN 1022:2005, L1
EN 16139:2013, L1

CERTIFICATIONS
TSCA title VI compliant

PACKAGING TYPE
Brown box

PACKAGING MEASUREMENTS (H x W x D)

1 Seater
77 cm x 91 cm x 95 cm / 30,3" x 35,8" x 37,4"

2 Seater
77 cm x 91 cm x 171 cm / 30,3" x 35,8" x 67,3"

3 Seater
77 cm x 91 cm x 225 cm / 30,3" x 31,8" x 88,6"

MATERIALS & MAINTENANCE
Please see page 486 for materials and care and maintenance instructions.

1 SEATER

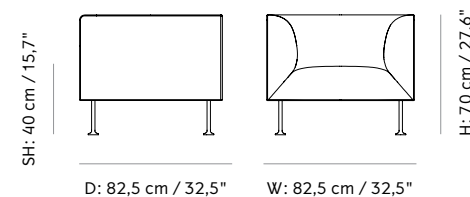

2 SEATER

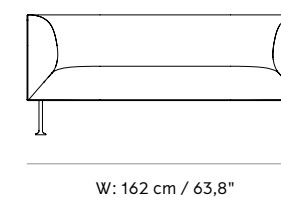



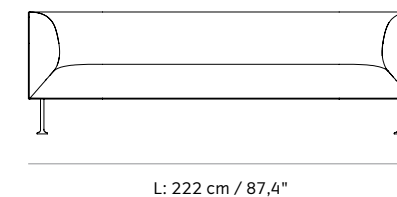







3 SEATER



Godot Sofa

BY ISKOS-BERLIN

RECOMMENDED COMBINATIONS — PRICES IN EUR *Selected combinations 6–8 weeks delivery time.*

SKU	VARIANT	INCL. VAT	EXCL. VAT
1 Seater — Seat with upholstery			
9710049	 GODOT SOFA, 1 SEATER / REMIX 2, 233	2.299,95	1.924,60
9710189	 GODOT SOFA, 1 SEATER / HALLINGDAL 65 / 180	2.649,95	2.217,48
9710939	 GODOT SOFA, 1 SEATER / COLLINE 568	2.649,95	2.217,48
400272	 GODOT, 1 SEATER / DOPPIOPANAMA 001	3.449,95	2.886,92
2 Seater — Seat with upholstery			
9720049	 GODOT SOFA, 2 SEATER / REMIX 2, 233	2.999,95	2.510,36
9720189	 GODOT SOFA, 2 SEATER / HALLINGDAL 65 / 180	3.449,95	2.886,92
9720939	 GODOT SOFA, 2 SEATER / COLLINE 568	3.449,95	2.886,92
3 Seater — Seat with upholstery			
9730049	 GODOT SOFA, 3 SEATER / REMIX 2, 233	3.799,95	3.179,80
9730189	 GODOT SOFA, 3 SEATER / HALLINGDAL 65 / 180	4.369,95	3.656,77
9730939	 GODOT SOFA, 3 SEATER / COLLINE 568	4.369,95	3.656,77

Additional charge of 10% for CMHR foam in accordance with UK requirement.
Option to upholster with customer's own fabric available upon request. For further information please see our upholstery programme on page 464.

Godot Sofa

BY ISKOS-BERLIN

SPEC OPTIONS — PRICES IN EUR *Selected combinations 6–8 weeks delivery time.*

SKU	VARIANT	INCL. VAT	EXCL. VAT
1 Seater — Textile — Seat with upholstery			
9710001	PRICE CATEGORY 1 Remix 2, Kvadrat / Hot Madison, JAB / Gaja C2C, Gabriel / Pastel Poetry, JAB	2.299,95	1.924,60
9710002	PRICE CATEGORY 2 Hallingdal 65, Kvadrat / Colline, Kvadrat / Canvas, Kvadrat / Fiord, Kvadrat / Steelcut 2, Kvadrat / Steelcut Trio 3, Kvadrat	2.649,95	2.217,48
9710003	PRICE CATEGORY 3 Vintage, Astrid / Safire, Kvadrat / Satoriale Collection: Grisaille, Dedar / Ponpon, Dedar	2.989,95	2.501,99
9710008	PRICE CATEGORY 4 (NEW) Satoriale Collection: Doppiopanama, Dedar / Deco, Dedar Texturologie Collection: Lupo, Dedar / Atlas, Dedar	3.449,95	2.886,92
2 Seater — Textile — Seat with upholstery			
9720001	PRICE CATEGORY 1 Remix 2, Kvadrat / Hot Madison, JAB / Gaja C2C, Gabriel / Pastel Poetry, JAB	2.299,95	1.924,60
9720002	PRICE CATEGORY 2 Hallingdal 65, Kvadrat / Colline, Kvadrat / Canvas, Kvadrat / Fiord, Kvadrat / Steelcut 2, Kvadrat / Steelcut Trio 3, Kvadrat	2.649,95	2.217,48
9720003	PRICE CATEGORY 3 Vintage, Astrid / Safire, Kvadrat / Satoriale Collection: Grisaille, Dedar / Ponpon, Dedar	2.989,95	2.501,99
9720008	PRICE CATEGORY 4 (NEW) Satoriale Collection: Doppiopanama, Dedar / Deco, Dedar Texturologie Collection: Lupo, Dedar / Atlas, Dedar	3.449,95	2.886,92
3 Seater — Textile — Seat with upholstery			
9730001	PRICE CATEGORY 1 Remix 2, Kvadrat / Hot Madison, JAB / Gaja C2C, Gabriel / Pastel Poetry, JAB	3.799,95	3.179,80
9730002	PRICE CATEGORY 2 Hallingdal 65, Kvadrat / Colline, Kvadrat / Canvas, Kvadrat / Fiord, Kvadrat / Steelcut 2, Kvadrat / Steelcut Trio 3, Kvadrat	4.369,95	3.656,77
9730003	PRICE CATEGORY 3 Vintage, Astrid / Safire, Kvadrat / Satoriale Collection: Grisaille, Dedar / Ponpon, Dedar	4.939,95	4.133,75
9730008	PRICE CATEGORY 4 (NEW) Satoriale Collection: Doppiopanama, Dedar / Deco, Dedar Texturologie Collection: Lupo, Dedar / Atlas, Dedar	5.699,95	4.769,72

Offset Sofa

BY NORM ARCHITECTS

One-, two- and three-seater sofas set on a wooden frame with down- and foam-filled upholstered cushions.

Offset Sofa, 3-seater, Colline 228, by Norm Architects
Plinth Low, Grey Kendzo Marble, by Norm Architects
Échasse Vase, Small, Clear Glass / Bronzed Brass, by Theresa Rand



PRODUCT OPTIONS

1 SEATER



2 SEATER



3 SEATER



SPEC OPTIONS

Available in fabrics from our upholstery programme. Standard lead times apply. Custom upholstery available upon request. For further information please refer to MENU Upholstery Programme.

Offset Sofa

BY NORM ARCHITECTS

TECHNICAL SPECIFICATIONS

PRODUCT TYPE
Sofa / Seating

ENVIRONMENT
Indoor

DIMENSIONS

1 Seater
H: 59 cm / 23,2"
SH: 37 cm / 14,6"
W: 97 cm / 38,2"
D: 90 cm / 35,4"

2 Seater
H: 59 cm / 23,2"
SH: 37 cm / 14,6"
W: 182 cm / 71,6"
D: 90 cm / 35,4"

3 Seater
H: 59 cm / 23,2"
SH: 37 cm / 14,6"
W: 225 cm / 88,6"
D: 90 cm / 35,4"

PRODUCTION PROCESS

The seaters are constructed with a structural frame made from pine, plywood and MDF. Seat consists of a double foam layer with no-zag springs. Back cushions are made with a foam core, surrounded by a casing with 50% feathers / 50% foam granulate. Armrest cushions are made from 50% feathers / 50% foam granulate.

COLOUR

Glides
Black (RAL 9005)

Seat
Dependent upon selected upholstery.

MATERIALS

Construction
Pine, plywood, MDF, steel (spring) and Upholstery

Foam seat
HR Foam, (30 kg / 120 N)

Armrest and back
Inner layer - 40 kg / 400 N
Outer layer - 18 kg / 160 N

Cushion
50 % feather and 50 % foam granulate.

WEIGHT

1 Seater: 44 kg / 97 lb
2 Seater: 73 kg / 160,9 lb
3 Seater: 87 kg / 191,8 lb

TEST
N / A

CERTIFICATIONS
TSCA title VI compliant

PACKAGING TYPE
Brown box

PACKAGING MEASUREMENTS (H x W x D)

1 Seater
61 cm x 99 cm x 92 cm / 24" x 39" x 36,2"

2 Seater
61 cm x 185 cm x 92 cm / 24" x 72,8" x 36,2"

3 Seater
61 cm x 228 cm x 92 cm / 24" x 89,8" x 36,2"

MATERIALS & MAINTENANCE

Please see page 486 for materials and care and maintenance instructions.

1 SEATER

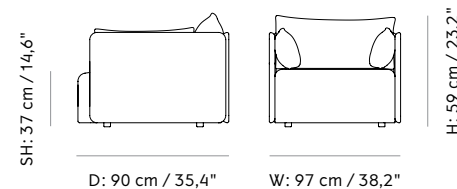

2 SEATER

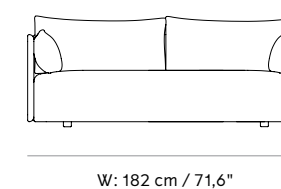

3 SEATER

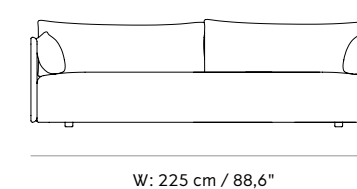

Offset Sofa

BY NORM ARCHITECTS

RECOMMENDED COMBINATIONS — PRICES IN EUR *Selected combinations 6–8 weeks delivery time.*







SKU	VARIANT	INCL. VAT	EXCL. VAT
1 Seater — Seat with upholstery			
9849029	 OFFSET SOFA, 1 SEATER / SAVANNA 202	3.129,95	2.619,14
9849069	 OFFSET SOFA, 1 SEATER / MAPLE 222	2.499,95	2.091,96
2 Seater — Seat with upholstery			
9850029	 OFFSET SOFA, 2 SEATER / SAVANNA 202	3.199,95	2.677,72
9850069	 OFFSET SOFA, 2 SEATER / MAPLE 222	2.559,95	2.142,17
3 Seater — Seat with upholstery			
9851029	 OFFSET SOFA, 3 SEATER / SAVANNA 202	3.629,95	3.037,54
9851069	 OFFSET SOFA, 3 SEATER / MAPLE 222	2.899,95	2.426,68

Additional charge of 10% for CMHR foam in accordance with UK requirement.
Option to upholster with customer's own fabric available upon request. For further information please see our upholstery programme on page 464.

Offset Sofa

BY NORM ARCHITECTS

RECOMMENDED COMBINATIONS — PRICES IN EUR *Selected combinations 6–8 weeks delivery time.*

SKU	VARIANT	INCL. VAT	EXCL. VAT
1 Seater — Seat with upholstery			
9849929	 OFFSET SOFA, 1 SEATER / COLLINE 228	3.129,95	2.619,14
9849909	 OFFSET SOFA, 1 SEATER / SAFIRE 001	3.629,95	3.037,54
2 Seater — Seat with upholstery			
9850929	 OFFSET SOFA, 2 SEATER / COLLINE 228	3.199,95	2.677,72
9850909	 OFFSET SOFA, 2 SEATER / SAFIRE 001	3.719,95	3.112,85
3 Seater — Seat with upholstery			
9851929	 OFFSET SOFA, 3 SEATER / COLLINE 228	3.629,95	3.037,54
400271	 OFFSET SOFA, 3-SEATER / GREENLAND 070	3.629,95	3.037,54
9851909	 OFFSET SOFA, 3-SEATER / SAFIRE 001	4.209,95	3.522,89

Additional charge of 10% for CMHR foam in accordance with UK requirement.
Option to upholster with customer's own fabric available upon request. For further information please see our upholstery programme on page 464.

Offset Sofa

BY NORM ARCHITECTS

SPEC OPTIONS — PRICES IN EUR *Selected combinations 6–8 weeks delivery time.*

SKU	VARIANT	INCL. VAT	EXCL. VAT
1 Seater — Textile — Seat with upholstery			
9849001	PRICE CATEGORY 1 Maple, Kvadrat / Remix 2, Kvadrat / City Velvet, JAB / Hot Madison Reloaded, JAB / Gaja C2C, Gabriel / Champion, Kvadrat	2.499,95	2.091,96
9849002	PRICE CATEGORY 2 Hallingdal 65, Kvadrat / Savanna, Kvadrat / Colline, Kvadrat / Canvas, Kvadrat / Ritz, Nevotex / Fiord, Kvadrat / Steelcut 2, Kvadrat / Steelcut Trio 3, Kvadrat / Moss, Kvadrat / Clay, Kvadrat / Divina Melange, Kvadrat	3.129,95	2.619,14
9849003	PRICE CATEGORY 3 Vintage, Astrid / Safire, Kvadrat / Satoriale Collection: Grisaille, Dedar / Ponpon, Dedar	3.629,95	3.037,54
9849008	PRICE CATEGORY 4 (NEW) Satoriale Collection: Doppiopanama, Dedar / Deco, Dedar Texturologie Collection: Lupo, Dedar / Atlas, Dedar	3.999,95	3.347,16
2 Seater — Textile — Seat with upholstery			
9850001	PRICE CATEGORY 1 Maple, Kvadrat / Remix 2, Kvadrat / City Velvet, JAB / Hot Madison Reloaded, JAB / Gaja C2C, Gabriel / Champion, Kvadrat	2.559,95	2.142,17
9850002	PRICE CATEGORY 2 Hallingdal 65, Kvadrat / Savanna, Kvadrat / Colline, Kvadrat / Canvas, Kvadrat / Ritz, Nevotex / Fiord, Kvadrat / Steelcut 2, Kvadrat / Steelcut Trio 3, Kvadrat / Moss, Kvadrat / Clay, Kvadrat / Divina Melange, Kvadrat	3.199,95	2.677,72
9850003	PRICE CATEGORY 3 Vintage, Astrid / Safire, Kvadrat / Satoriale Collection: Grisaille, Dedar / Ponpon, Dedar	3.719,95	3.112,85
9850008	PRICE CATEGORY 4 (NEW) Satoriale Collection: Doppiopanama, Dedar / Deco, Dedar Texturologie Collection: Lupo, Dedar / Atlas, Dedar	4.099,95	3.430,84
3 Seater — Textile — Seat with upholstery			
9851001	PRICE CATEGORY 1 Maple, Kvadrat / Remix 2, Kvadrat / City Velvet, JAB / Hot Madison Reloaded, JAB / Gaja C2C, Gabriel / Champion, Kvadrat	2.899,95	2.426,68
9851002	PRICE CATEGORY 2 Hallingdal 65, Kvadrat / Savanna, Kvadrat / Colline, Kvadrat / Canvas, Kvadrat / Ritz, Nevotex / Fiord, Kvadrat / Steelcut 2, Kvadrat / Steelcut Trio 3, Kvadrat / Moss, Kvadrat / Clay, Kvadrat / Divina Melange, Kvadrat	3.629,95	3.037,54
9851003	PRICE CATEGORY 3 Vintage, Astrid / Safire, Kvadrat / Satoriale Collection: Grisaille, Dedar / Ponpon, Dedar	4.209,95	3.522,89
9851008	PRICE CATEGORY 4 (NEW) Satoriale Collection: Doppiopanama, Dedar / Deco, Dedar Texturologie Collection: Lupo, Dedar / Atlas, Dedar	4.639,95	3.882,71

Column Table Lamp, by Norm Architects
Plinth Tall, Calacatta Viola Marble, by Norm Architects
Plinth Low, Calacatta Viola Marble, by Norm Architects
Offset Sofa, 3-Seater, Savanna 202, by Norm Architects



Tailor Sofa

BY RUI ALVES

Solid natural oak or dark stained oak frame sofa with upholstered seat.

PRODUCT OPTIONS

SEAT



WITH TEXTILE



WITH LEATHER

OAK FRAME



NATURAL OAK



DARK STAINED OAK

SPEC OPTIONS

Available in fabrics from our upholstery programme. Standard lead times apply. Custom upholstery available upon request. For further information please refer to MENU Upholstery Programme.

Tailor Sofa, Dark Stained Oak / Dakar 0311, by Rui Alves



Tailor Sofa

BY RUI ALVES

TECHNICAL SPECIFICATIONS

PRODUCT TYPE
Sofa

ENVIRONMENT
Indoor

DIMENSIONS
H: 75 cm / 29,5"
SH: 41 cm / 16,1"
W: 180 cm / 70,6"
D: 71 cm / 28"

PRODUCTION PROCESS
Frame is made of steam-bent solid oak, with a soap treated finish. Shell is moulded from fibreglass and upholstered. Seat cushions are made from cold foam.

COLOUR

Frame
Natural oak
Dark stained oak

Seat
Dependent upon selected upholstery.

MATERIALS
Solid oak, fibreglass, CAL117, upholstery.

WEIGHT
38 kg / 83,8 lb

TEST
EN1022:2005, L1
EN16139:2013, L1

CERTIFICATIONS
N / A

PACKAGING TYPE
Brown box

PACKAGING MEASUREMENTS (H x W x D)
80 cm x 194 cm x 80 cm / 31,5" x 76,4" x 31,5"



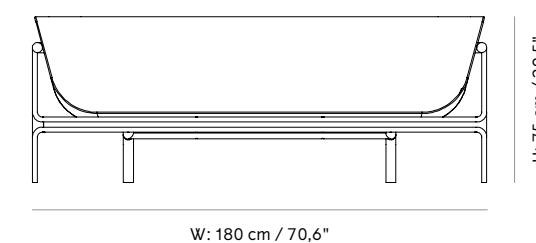
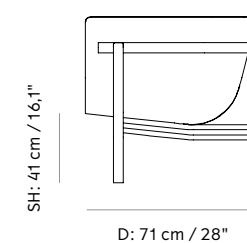



MATERIALS & MAINTENANCE
Please see page 486 for materials and care and maintenance instructions.



Tailor Sofa

BY RUI ALVES

RECOMMENDED COMBINATIONS — PRICES IN EUR *Selected combinations 6–8 weeks delivery time.*

SKU	VARIANT	INCL. VAT	EXCL. VAT
Seat with upholstery — Oak base — Natural oak			
9900069	 TAILOR SOFA, NATURAL OAK / MAPLE 222	4.699,95	3.932,92
9900019	 TAILOR SOFA, NATURAL OAK / HALLINGDAL 65/103	5.169,95	4.326,21
9900169	 TAILOR SOFA, NATURAL OAK / DAKAR 0311	6.109,95	5.112,81
Seat with upholstery — Oak base — Dark stained oak			
9910069	 TAILOR SOFA, DARK STAINED OAK / MAPLE 222	4.999,95	4.183,96
9910019	 TAILOR SOFA, DARK STAINED OAK / HALLINGDAL 65/103	5.499,95	4.602,36
9910169	 TAILOR SOFA, DARK STAINED OAK / DAKAR 0311	6.499,95	5.439,16

Additional charge of 10% for CMHR foam in accordance with UK requirement.
Option to upholster with customer's own fabric available upon request. For further information please see our upholstery programme on page 464.



Tailor Sofa, Dark Stained Oak / Dakar 0311, by Rui Alves

Tailor Sofa

BY RUI ALVES

SPEC OPTIONS — PRICES IN EUR *Selected combinations 6–8 weeks delivery time.*

SKU	VARIANT	INCL. VAT	EXCL. VAT
Textile — Seat with upholstery — Oak base — Natural oak			
9900001	PRICE CATEGORY 1 Maple, Kvadrat / Remix 2, Kvadrat / Hot Madison, JAB / Gaja C2C, Gabriel / Pastel Poetry, JAB	4.699,95	3.932,92
9900002	PRICE CATEGORY 2 Hallingdal 65, Kvadrat / Savanna, Kvadrat / Colline, Kvadrat / Canvas, Kvadrat / Fiord, Kvadrat / Steelcut 2, Kvadrat / Steelcut Trio 3, Kvadrat / Icon, Nevotex	5.169,95	4.326,21
9900003	PRICE CATEGORY 3 Vintage, Astrid / Safire, Kvadrat / Satoriale Collection: Grisaille, Dedar / Ponpon, Dedar	5.639,95	4.719,51
9900008	PRICE CATEGORY 4 (NEW) Satoriale Collection: DoppioPanama, Dedar / Deco, Dedar Texturologie Collection: Lupo, Dedar / Atlas, Dedar	6.579,95	5.506,10
Leather — Seat with upholstery — Oak base — Natural oak			
9900004	PRICE CATEGORY 1 Ultra, Sørensen Leather / Dakar, Nevotex	6.109,95	5.112,81
9900005	PRICE CATEGORY 2 Dunes, Sørensen Leather / Shade, Sørensen Leather / Nuance, Sørensen Leather / Instill, Kvadrat	7.049,95	5.899,40
9900006	PRICE CATEGORY 3 Royal Nubuck, Sørensen Leather	7.989,95	6.685,99
9900007	PRICE CATEGORY 4 Elegance, Sørensen Leather	9.869,95	8.259,17

Additional charge of 10% for CMHR foam in accordance with UK requirement.
Option to upholster with customer's own fabric available upon request. For further information please see our upholstery programme on page 464.

Tailor Sofa

BY RUI ALVES

SPEC OPTIONS — PRICES IN EUR *Selected combinations 6–8 weeks delivery time.*

SKU	VARIANT	INCL. VAT	EXCL. VAT
Textile — Seat with upholstery — Oak base — Dark stained oak			
9910001	PRICE CATEGORY 1 Maple, Kvadrat / Remix 2, Kvadrat / Hot Madison, JAB / Gaja C2C, Gabriel / Pastel Poetry, JAB	4.999,95	4.183,96
9910002	PRICE CATEGORY 2 Hallingdal 65, Kvadrat / Savanna, Kvadrat / Colline, Kvadrat / Canvas, Kvadrat / Fiord, Kvadrat / Steelcut 2, Kvadrat / Steelcut Trio 3, Kvadrat / Icon, Nevotex	5.499,95	4.602,36
9910003	PRICE CATEGORY 3 Vintage, Astrid / Safire, Kvadrat / Satoriale Collection: Grisaille, Dedar / Ponpon, Dedar	5.999,95	5.020,76
9910008	PRICE CATEGORY 4 (NEW) Satoriale Collection: DoppioPanama, Dedar / Deco, Dedar Texturologie Collection: Lupo, Dedar / Atlas, Dedar	6.999,95	5.857,56
Leather — Seat with upholstery — Oak base — Dark stained oak			
9910004	PRICE CATEGORY 1 Ultra, Sørensen Leather / Dakar, Nevotex	6.499,95	5.439,16
9910005	PRICE CATEGORY 2 Dunes, Sørensen Leather / Shade, Sørensen Leather / Nuance, Sørensen Leather / Instill, Kvadrat	7.499,95	6.275,96
9910006	PRICE CATEGORY 3 Royal Nubuck, Sørensen Leather	8.499,95	7.112,76
9910007	PRICE CATEGORY 4 Elegance, Sørensen Leather	10.499,95	8.786,36

Additional charge of 10% for CMHR foam in accordance with UK requirement.
Option to upholster with customer's own fabric available upon request. For further information please see our upholstery programme on page 464.

Zet Storing System

BY KASCHKASCH

Wood veneer U-shaped shelves with powder coated metal frame with supportive Z-struts.

PRODUCT OPTIONS

VENEER SHELF



BLACK STAINED OAK

POWDER COATED STEEL BASE



BLACK STEEL

Zet Storing System, 2x4 Black Painted Oak Veneer / Black Steel, by Kaschkasch



Zet Storing System

BY KASCHKASCH

STOCK OPTIONS — PRICES IN EUR *Selected combinations up to 2 weeks delivery time.*

SKU	VARIANT	INCL. VAT	EXCL. VAT
7335539	ZET, STORING SYSTEM, 1X2, BLACK STEEL / BLACK STAINED OAK	549,95	460,20
7337539	ZET, STORING SYSTEM, 2X2, BLACK STEEL / BLACK STAINED OAK	999,95	836,76
7336539	ZET, STORING SYSTEM, 1X4, BLACK STEEL / BLACK STAINED OAK	999,95	836,76
7338539	ZET, STORING SYSTEM, 2X4, BLACK STEEL / BLACK STAINED OAK	1.999,95	1.673,56

TECHNICAL SPECIFICATIONS

PRODUCT TYPE Storage system	COLOUR Black (RAL 9005) / Black	CERTIFICATIONS TSCA title VI compliant
ENVIRONMENT Indoor	GLOSS Gloss 10-20	PACKAGING TYPE Brown box
DIMENSIONS 1x2 W: 92,5 cm / 36,4" D: 40 cm / 15,7" H: 76,5 cm / 30,1" 2x2 W: 183 cm / 72" D: 40 cm / 15,7" H: 76,5 cm / 30,1" 1x4 W: 92,5 cm / 36,4" D: 40 cm / 15,7" H: 154,5 cm / 60,8" 2x4 W: 183 cm / 72" D: 40 cm / 15,7" H: 154,5 cm / 60,8"	MATERIALS Base Powder coated steel Shelves MDF, black stained oak veneer WEIGHT 1x2: 15 kg / 33,1 lb 2x2: 27,5 kg / 60,6 lb 1x4: 30 kg / 66,1 lb 2x4: 55,5 kg / 122,4" lb	PACKAGING MEASUREMENTS (H x W x D) 1x2 16 cm x 47 cm x 110 cm / 6,3" x 18,5" x 43,3" 2x2 116 cm x 47 cm x 32 cm / 45,7" x 18,5" x 12,6" 1x4 116 cm x 58 cm x 40 cm / 45,7" x 22,8" x 15,7" 2x4 116 cm x 62 cm x 47 cm / 45,7" x 24,4" x 18,5"
PRODUCTION PROCESS Bases are made of welded steel rods with powder coated finish. Shelves are made of oak veneered MDF. Edges by miter joints. The veneer finish is stained with a matt-lacquer surface.	TEST N / A	MATERIALS & MAINTENANCE Please see page 486 for materials and care and maintenance instructions.

1X2

2X2

1X4

2X4

H: 76,5 cm / 30,1"

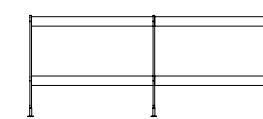
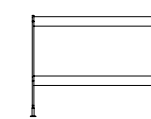
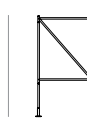

H: 154,5 cm / 60,8"

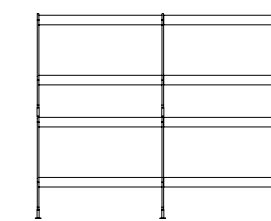
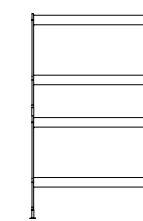
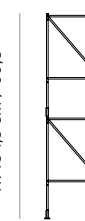

D: 40 cm / 15,7" W: 92,5 cm / 36,4"

W: 183 cm / 72"

D: 40 cm / 15,7" W: 92,5 cm / 36,4"

W: 183 cm / 72"

Stick System

BY JAN & HENRY

Powder coated steel shelves with solid ash base.

PRODUCT OPTIONS

POWDER COATED STEEL SHELVES



BLACK STEEL

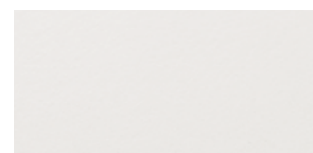

WHITE STEEL

ASH STICK



DARK ASH



WHITE ASH

Stick System, 1x4, Grey Steel / Dark Ash, by Jan & Henry
TR Bulb Table / Wall Lamp, Marble / Matte Opal, by Tim Rundle



Stick System

BY JAN & HENRY

STOCK OPTIONS — PRICES IN EUR *Selected combinations up to 2 weeks delivery time.*

SKU	VARIANT	INCL. VAT	EXCL. VAT
50008	STICK SYSTEM, 1X2, BLACK STEEL / DARK ASH	349,95	292,84
50016	STICK SYSTEM, 1X2, WHITE STEEL / WHITE ASH	349,95	292,84
50009	STICK SYSTEM, 1X3, BLACK STEEL / DARK ASH	549,95	460,20
50017	STICK SYSTEM, 1X3, WHITE STEEL / WHITE ASH	549,95	460,20
50010	STICK SYSTEM, 1X4, BLACK STEEL / DARK ASH	699,95	585,72
50018	STICK SYSTEM, 1X4, WHITE STEEL / WHITE ASH	699,95	585,72
50011	STICK SYSTEM, 1X5, BLACK STEEL / DARK ASH	829,95	694,50
50019	STICK SYSTEM, 1X5, WHITE STEEL / WHITE ASH	829,95	694,50

TECHNICAL SPECIFICATIONS

PRODUCT TYPE

Storage system

ENVIRONMENT

Indoor

DIMENSIONS

1x2
H: 58 cm / 22,8"
W: 73,4 cm / 28,9"
D: 50,1 cm / 19,7"

1x4
H: 133,4 cm / 52,5"
W: 73,4 cm / 28,9"
D: 50,1 cm / 19,7"

1x3
H: 95,7 cm / 37,7"
W: 73,4 cm / 28,9"
D: 50,1 cm / 19,7"

1x5
H: 171,1 cm / 67,4"
W: 73,4 cm / 28,9"
D: 50,1 cm / 19,7"

PRODUCTION PROCESS

Turned solid wood frame with machine-cut and bent steel plates with a powder coated surface. Connection bracket is made of welded steel tubes with a powder coated surface.

COLOUR

Black (RAL 9005) / Dark ash
White (RAL 9016) / White

GLOSS

Gloss 5 - 10

MATERIALS

White painted ash or dark stained ash and powder coated steel.

WEIGHT

Depending on configuration.

TEST

N / A

CERTIFICATIONS

N / A

PACKAGING TYPE

Brown box

PACKAGING MEASUREMENTS (H x W x D)

Depending on configuration.

MATERIALS & MAINTENANCE

Please see page 486 for materials and care and maintenance instructions.

1X2



D: 50,1 cm / 19,7" W: 73,4 cm / 28,9"

1X3

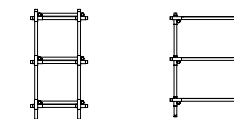

H: 58 cm / 22,8"

D: 50,1 cm / 19,7" W: 73,4 cm / 28,9"

1X4

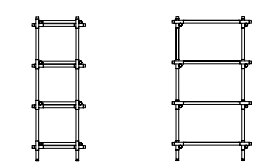

H: 95,7 cm / 37,7"

D: 50,1 cm / 19,7" W: 73,4 cm / 28,9"

1X5

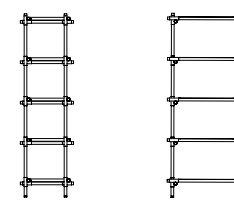

H: 133,4 cm / 52,5"

D: 50,1 cm / 19,7" W: 73,4 cm / 28,9"

H: 171,1 cm / 67,4"

Stick System

BY JAN & HENRY

Powder coated steel shelves with solid ash base.

PRODUCT OPTIONS

POWDER COATED STEEL SHELVES



BLACK STEEL

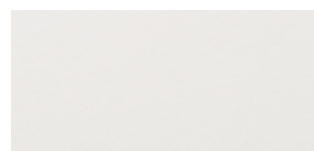

WHITE STEEL

ASH STICK



DARK ASH



WHITE ASH

Stick System, 3x3, Grey Steel / Dark Ash, by Jan & Henry



Stick System

BY JAN & HENRY

STOCK OPTIONS — PRICES IN EUR

Selected combinations up to 2 weeks delivery time.

SKU	VARIANT	INCL. VAT	EXCL. VAT
50012	STICK SYSTEM, 3X2, BLACK STEEL / DARK ASH	829,95	694,50
50020	STICK SYSTEM, 3X2, WHITE STEEL / WHITE ASH	829,95	694,50
50013	STICK SYSTEM, 3X3, BLACK STEEL / DARK ASH	1.249,95	1.045,96
50021	STICK SYSTEM, 3X3, WHITE STEEL / WHITE ASH	1.249,95	1.045,96
50014	STICK SYSTEM, 3X4, BLACK STEEL / DARK ASH	1.629,95	1.363,94
50022	STICK SYSTEM, 3X4, WHITE STEEL / WHITE ASH	1.629,95	1.363,94
50015	STICK SYSTEM, 3X5, BLACK STEEL / DARK ASH	2.029,95	1.698,66
50023	STICK SYSTEM, 3X5, WHITE STEEL / WHITE ASH	2.029,95	1.698,66

TECHNICAL SPECIFICATIONS

PRODUCT TYPE

Storing system

ENVIRONMENT

Indoor

DIMENSIONS

3x2
H: 58 cm / 22,8"
W: 195,4 cm / 76,9"
D: 50,1 cm / 19,7"

3x4
H: 133,4 cm / 52,5"
W: 195,4 cm / 76,9"
D: 50,1 cm / 19,7"

3x3
H: 95,7 cm / 37,7"
W: 195,4 cm / 76,9"
D: 50,1 cm / 19,7"

3x5
H: 171,1 cm / 67,4"
W: 195,4 cm / 76,9"
D: 50,1 cm / 19,7"

PRODUCTION PROCESS

Turned solid wood frame with machine-cut and bent steel plates with a powder coated surface. Connection bracket is made of welded steel tubes with a powder coated surface.

COLOUR

Black (RAL 9005) / Dark ash
White (RAL 9016) / White

GLOSS

Gloss 5 - 10

MATERIALS

White painted ash or dark stained ash and powder coated steel.

WEIGHT

Depending on configuration.

TEST

N / A

CERTIFICATIONS

N / A

PACKAGING TYPE

Brown box

PACKAGING MEASUREMENTS (H x W x D)

Depending on configuration.

MATERIALS & MAINTENANCE

Please see page 486 for materials and care and maintenance instructions.

3X2

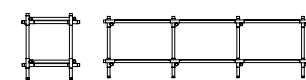

D: 50,1 cm / 19,7" W: 195,4 cm / 76,9"

H: 58 cm / 22,8"

3X3

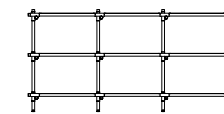

W: 195,4 cm / 76,9"

H: 95,7 cm / 37,7"

3X4

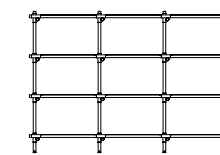

W: 195,4 cm / 76,9"

H: 133,4 cm / 52,5"

3X5

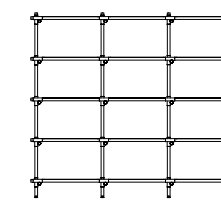

W: 195,4 cm / 76,9"

H: 171,1 cm / 67,4"

WM String Chair

BY STUDIO WM

Tubular powder coated steel chair with inverted backrest.



WM String Dining Chair, Black, by Studio WM
WM String Lounge Chair, White, by Studio WM



PRODUCT OPTIONS

SEAT OPTIONS



DINING CHAIR



LOUNGE CHAIR

POWDER COATED STEEL BASE

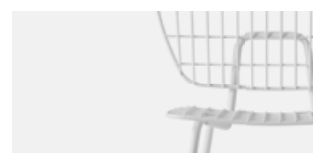

WHITE STEEL

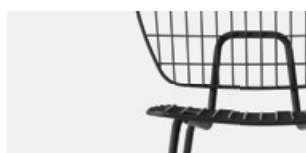

BLACK STEEL

WM String Chair

BY STUDIO WM

STOCK OPTIONS — PRICES IN EUR *Selected combinations up to 2 weeks delivery time.*

SKU	VARIANT	INCL. VAT	EXCL. VAT
9520539	WM STRING DINING CHAIR, BLACK STEEL	229,95	192,42
9520639	WM STRING DINING CHAIR, WHITE STEEL	229,95	192,42
9500539	WM STRING LOUNGE CHAIR, BLACK STEEL	279,95	234,26
9500639	WM STRING LOUNGE CHAIR, WHITE STEEL	279,95	234,26

TECHNICAL SPECIFICATIONS

PRODUCT TYPE
Chair

ENVIRONMENT
Indoor
Outdoor

DIMENSIONS

Dining chair:
H: 80 cm / 31,5"
SH: 45,5 cm / 17,9"
W: 53 cm / 30,9"
D: 50 cm / 19,7"

Lounge chair:
H: 71,5 cm / 28,1"
SH: 36 cm / 14,2"
W: 66 cm / 26"
D: 53 cm / 20,9"

PRODUCTION PROCESS
The chair is made from powder coated bent steel tubes.

COLOUR
Black (RAL 9005)
White (RAL 9016)

GLOSS
Gloss 10-20

MATERIALS
ED Coating, powder coated steel

WEIGHT
Dining chair: 4,3 kg / 9,5 lb
Lounge chair: 4,9 kg / 10,8 lb

TEST
EN 1022:2005, L1
EN 16139:2013, L1

CERTIFICATIONS
N / A

PACKAGING TYPE
Brown box

PACKAGING MEASUREMENTS (H x W x D)

Dining Chair
80,2 cm x 52,8 cm x 48 cm / 31,6" x 23,1" x 18,9"

Lounge Chair
71 cm x 65,5 cm x 53,5 cm / 28" x 25,8" x 21"

MATERIALS & MAINTENANCE
Please see page 486 for materials and care and maintenance instructions.

WM STRING DINING CHAIR

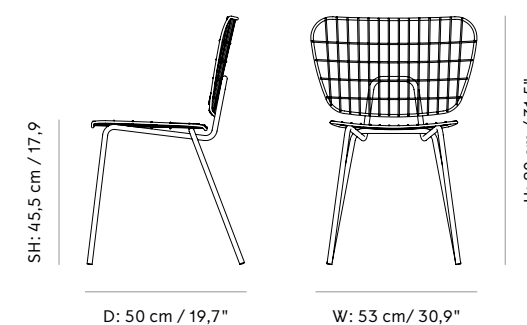

WM STRING LOUNGE CHAIR

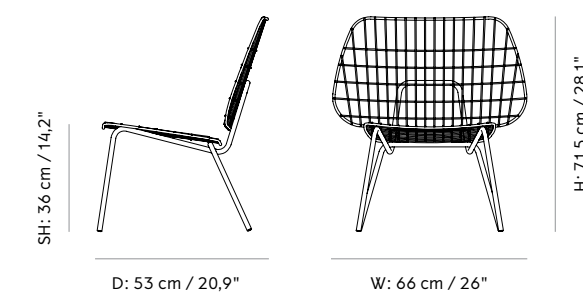

WM String Cushion

BY STUDIO WM

Table with wooden frame and grey ataija azul marble or black ash top with gently rounded edges.

String Dining Chair, White / Light Grey Cushion, by Studio WM



PRODUCT OPTIONS

CUSHION - WM STRING DINING CHAIR



Indoor, Light Grey
9575130



Indoor, Dark Grey
9575150



Outdoor, Dark Grey
9585150

CUSHION - WM STRING LOUNGE CHAIR



Indoor, Light Grey
9576130



Indoor, Dark Grey
9576150



Outdoor, Dark Grey
9586150

WM String Cushion

BY STUDIO WM

STOCK OPTIONS — PRICES IN EUR

Selected combinations up to 2 weeks delivery time.

SKU	VARIANT	INCL. VAT	EXCL. VAT
9575130	WM STRING DINING CHAIR, CUSHION, INDOOR / LIGHT GREY	99,95	83,64
9575150	WM STRING DINING CHAIR, CUSHION, INDOOR / DARK GREY	99,95	83,64
9585150	WM STRING DINING CHAIR, CUSHION, OUTDOOR / DARK GREY	99,95	83,64
9576130	WM STRING LOUNGE CHAIR, CUSHION, INDOOR / LIGHT GREY	99,95	83,64
9576150	WM STRING LOUNGE CHAIR, CUSHION, INDOOR / DARK GREY	99,95	83,64
9586150	WM STRING LOUNGE CHAIR, CUSHION, OUTDOOR / DARK GREY	99,95	83,64

TECHNICAL SPECIFICATIONS

PRODUCT TYPE
Cushion

ENVIRONMENT
Indoor and outdoor

DIMENSIONS

Dining
W: 40,5 cm / 15,9"
D: 37,5 cm / 14"

Lounge
W: 44,5 cm / 17,5"
D: 41 cm / 16,1"

PRODUCTION PROCESS
Upholstered cut foam with stitching around edge.

COLOUR
Indoor
Light grey (Gabriel Luna 2, 04013)
Dark grey (Gabriel Luna 2, 04011)

Outdoor
Dark grey (Sunbrella, Deauville, DEA 3737 140 - Ardoise)

GLOSS
N / A

MATERIALS
Gabriel textile for indoor og sunbrella textile for outdoor variant and HR foam.

WEIGHT
Dining: 300 g / 0,7 lb
Lounge: 350 g / 0,8 lb

TEST
N / A

CERTIFICATIONS
N / A

PACKAGING TYPE
Polybag

PACKAGING MEASUREMENTS (H x W x D)

Dining
W: 40,5 cm / 15,9"
D: 37,5 cm / 14"

Lounge
W: 44,5 cm / 17,5"
D: 41 cm / 16,1"

MATERIALS & MAINTENANCE
Please see page 486 for materials and care and maintenance instructions.

Septembre Lounge Table

BY THERESA RAND

Wooden base table with grey Ataija Azul marble or black ash top.

PRODUCT OPTIONS

TABLETOP

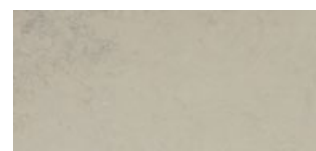

ATAÍJA AZUL MARBLE



BLACK PAINTED ASH

ASH BASE



BLACK STAINED ASH



BLACK PAINTED ASH

Septembre Coffee Table, Black Stained Ash / Ataija Azul marble, by Theresa Rand



Septembre Lounge Table

BY THERESA RAND

STOCK OPTIONS — PRICES IN EUR

Selected combinations up to 2 weeks delivery time.

SKU	VARIANT	INCL. VAT	EXCL. VAT
9840539	SEPTEMBRE LOUNGE TABLE, BLACK PAINTED ASH / BLACK ASH	999,95	836,76
9850539	SEPTEMBRE LOUNGE TABLE, BLACK STAINED ASH / GREY MARBLE	1.299,95	1.087,80

TECHNICAL SPECIFICATIONS

PRODUCT TYPE
Lounge table

ENVIRONMENT
Indoor

DIMENSIONS
H: 35 cm / 13,8"
L: 130 cm / 51,2"
W: 67 cm / 26,4"

PRODUCTION PROCESS
Tabletop is made from CNC milled MDF with oak veneer on top and edges or marble. Base is made from solid ash and turned solid ash, tapped together.

COLOUR
Black ash (RAL 9005)
Black stained ash / Grey marble

GLOSS
N / A

MATERIALS
Black stained solid ash, black stained ash veneer, MDF and Ataija Azul marble or painted solid ash, painted ash veneer and MDF.

WEIGHT
Black ash: 15,3 kg / 34,2 lb
Black stained ash / Grey marble: 37,4 kg / 82,5 lb

TEST
N / A

CERTIFICATIONS
N / A

PACKAGING TYPE
Brown box

PACKAGING MEASUREMENTS (H x W x D)
41 cm x 83 cm x 142 cm / 16,1" x 32,7" x 56"

MATERIALS & MAINTENANCE
Please see page 486 for materials and care and maintenance instructions.



W: 67 cm / 26,4"



L: 130 cm / 51,2"

H: 35 cm / 13,8"

NoNo Table

BY NORM ARCHITECTS & NOTE DESIGN STUDIO

Lounge table with powder coated steel base and glass tabletop. Available in two sizes.

NoNo Table, Small, Powder Coated Steel / Glass w/ Beige Silk Print, by Note Design Studio & Norm Architects
 NoNo Table, Small, Powder Coated Steel / Glass w/ Dark Green Silk Print, by Note Design Studio & Norm Architects



PRODUCT OPTIONS

TABLETOP

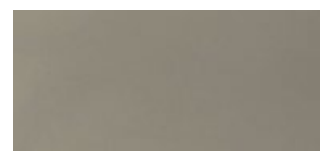

BEIGE GLASS

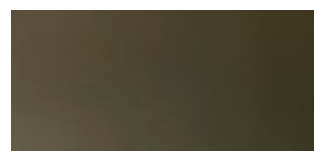

DARK GREEN GLASS



BROWN GLASS

POWDER COATED STEEL BASE



BLACK STEEL

NoNo Table

BY NORM ARCHITECTS & NOTE DESIGN STUDIO

STOCK OPTIONS — PRICES IN EUR *Selected combinations up to 2 weeks delivery time.*

SKU	VARIANT	INCL. VAT	EXCL. VAT
8560049	NONO TABLE, S, BEIGE	399,95	334,68
8561939	NONO TABLE, L, BROWN	699,95	585,72
8561499	NONO TABLE, L, DARK GREEN	699,95	585,72

TECHNICAL SPECIFICATIONS

PRODUCT TYPE
Lounge table

ENVIRONMENT
Indoor

DIMENSIONS

Small
H: 25 cm / 9,8"
W: 75 cm / 29,5"
D: 59,5 cm / 23,4"

Large
H: 35 cm / 13,8"
W: 96,5 cm / 38"
D: 50 cm / 19,5"

PRODUCTION PROCESS
Bent, welded steel tubes and flat wire with a powder coated surface. Tabletop in tempered glass with silk print.

COLOUR

Tabletop
Beige (Pantone 7531C)
Brown (Pantone 7533C)
Dark green (Pantone 449C)

Frame
Black (RAL 9005)

GLOSS
Gloss 10-20

MATERIALS
Powder coated steel; glass; silk print

WEIGHT
Small: 13,58 kg / 30 lb
Large: 15,6 kg / 34,4 lb

TEST
N / A

CERTIFICATIONS
N / A

PACKAGING TYPE
Brown box

PACKAGING MEASUREMENTS (H x W x D)

Small
13 cm x 84 cm x 57,5 / 5,1" x 33,1" x 22,6"

Large
13 cm x 103,5 cm x 66 cm / 5,1" x 40,7" x 26"

MATERIALS & MAINTENANCE
Please see page 486 for materials and care and maintenance instructions.

NONO TABLE SMALL

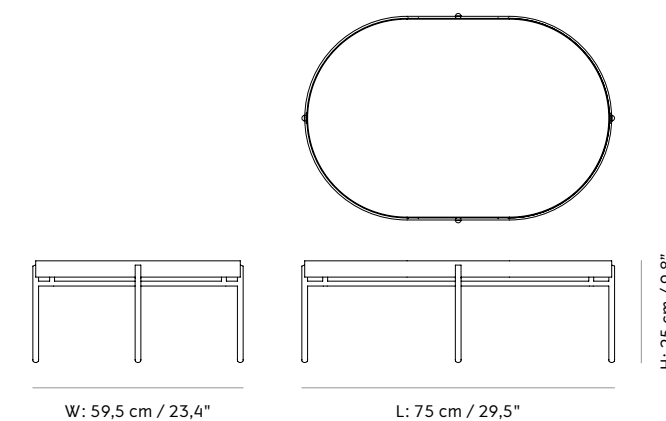

NONO TABLE LARGE

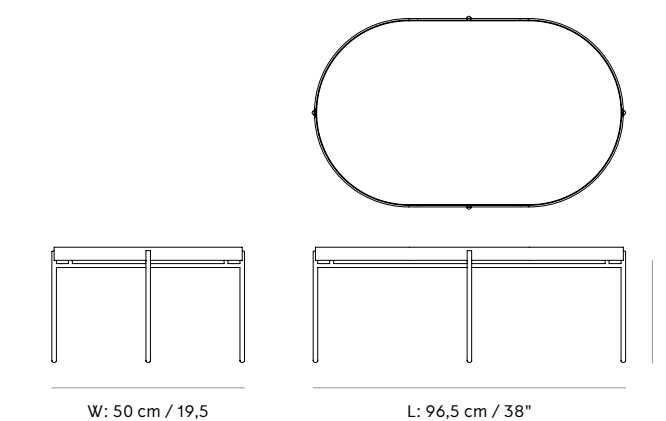

Rail Desk

BY KEIJI ASHIZAWA

Natural or stained oak desk with steel wall bracket.



Rail Desk, Dark Stained Oak, by Keiji Ashizawa
Co Chair, Black Steel / Dark Stained Oak / Dakar 0842,
by Norm Architects & Els Van Hoorebeek



PRODUCT OPTIONS

OAK TABLETOP



NATURAL OAK

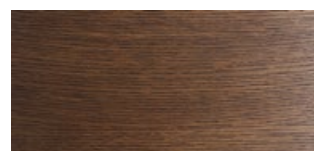

DARK STAINED OAK

POWDER COATED STEEL FRAME



BLACK

Rail Desk

BY KEIJI ASHIZAWA

STOCK OPTIONS — PRICES IN EUR

Selected combinations up to 2 weeks delivery time.

SKU	VARIANT	INCL. VAT	EXCL. VAT
1205039	RAIL DESK, BLACK STEEL / NATURAL OAK	299,95	251,00
1205849	RAIL DESK, BLACK STEEL / DARK STAINED OAK	299,95	251,00

TECHNICAL SPECIFICATIONS

PRODUCT TYPE
Wall table

ENVIRONMENT
Indoor

DIMENSIONS
H: 21,2 cm / 8,3"
W: 92 cm / 36,2"
D: 45 cm / 17,7"

PRODUCTION PROCESS
Tabletops are made from CNC-milled MDF with a 5 mm solid wood edge and glued veneer. The frame is made from welded square steel rods.

COLOUR

Tabletop
Natural oak
Dark stained oak

Frame
Black (RAL 9005)

GLOSS
Gloss 10-20

MATERIALS
Oak veneer, MDF, steel

WEIGHT
8,5 kg / 18,7 lb

TEST
N / A

CERTIFICATIONS
TSCA title VI compliant

PACKAGING TYPE
Brown box

PACKAGING MEASUREMENTS (H x W x D)

Tabletop
6 cm x 94,5 cm x 49,5 cm / 2,4" x 37,2" x 19,5"

Frame
26,5 x 95 cm x 40 cm / 10,4" x 37,4" x 15,7"

MATERIALS & MAINTENANCE
Please see page 486 for materials and care and maintenance instructions.



W: 92 cm / 36,2"

H: 21,2 cm / 8,3"

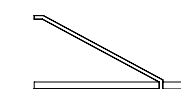

D: 45 cm / 17,7"

Yeh Wall Table

BY KENYON YEH

Powder coated steel table with angled back.

PRODUCT OPTIONS

LOW



White
8600639

TALL



White
8700639

Yeh Wall Table, Low, White Steel, by Kenyon Yeh
Yeh Wall Table, Tall, White Steel, by Kenyon Yeh



Yeh Wall Table

BY KENYON YEH

STOCK OPTIONS — PRICES IN EUR *Selected combinations up to 2 weeks delivery time.*

SKU	VARIANT	INCL. VAT	EXCL. VAT
8600639	YEH WALL TABLE, LOW / WHITE STEEL	129,95	108,74
8700639	YEH WALL TABLE, TALL / WHITE STEEL	179,95	150,58

TECHNICAL SPECIFICATIONS

PRODUCT TYPE Wall table	COLOUR Low White (RAL 9016) Tall White (RAL 9016)	CERTIFICATIONS N / A
ENVIRONMENT Indoor	GLOSS Gloss 10-20	PACKAGING TYPE Brown box
DIMENSIONS Low H: 45 cm / 17,7" W: 40 cm / 15,7" D: 32 cm / 12,6" Tall H: 71 cm / 28" W: 55 cm / 21,7" D: 44 cm / 17,3"	MATERIALS Powder coated steel	PACKAGING MEASUREMENTS (H x W x D) Low 12,5 cm x 43 cm x 33 cm / 4,9" x 16,9" x 13" Tall 15,5 cm x 64 cm x 45,5 cm / 6,1" x 25,2" x 17,9"
PRODUCTION PROCESS Powder coated bent steel plate with tubular steel base.	WEIGHT Low: 3,1 kg / 6,8 lb Tall: 5,8 kg / 12,8 lb	MATERIALS & MAINTENANCE Please see page 486 for materials and care and maintenance instructions.
	TEST N / A	

YEH WALL TABLE LOW

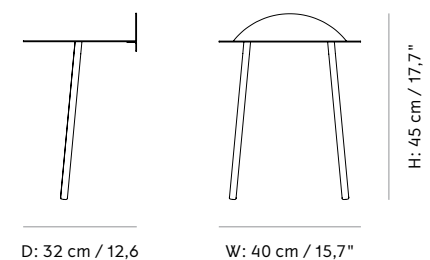

YEH WALL TABLE TALL

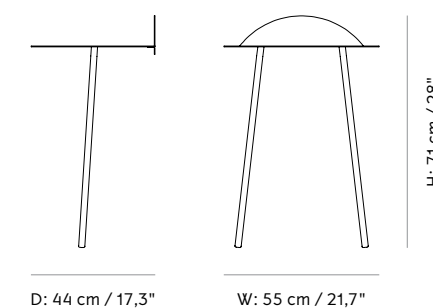

Gravel Rug

BY NINA BRUUN

Handwoven, looped wool rug in grey or ivory with tonal border in cotton.

Offset Sofa, 3-seater, Savanna 202, by Norm Architects
Gravel Rug, Ivory, by Nina Bruun



PRODUCT OPTIONS

SMALL



Grey
5850139



Ivory
5850649

LARGE



Grey
5851139



Ivory
5851649

Gravel Rug

BY NINA BRUUN

STOCK OPTIONS — PRICES IN EUR

Selected combinations up to 2 weeks delivery time.

SKU	VARIANT	INCL. VAT	EXCL. VAT
5850139	GRAVEL RUG, 170 X 200, GREY	799,95	669,40
5850649	GRAVEL RUG, 170 X 200, IVORY	799,95	669,40
5851139	GRAVEL RUG, 200 X 300, GREY	1.349,95	1.129,64
5851649	GRAVEL RUG, 200 X 300, IVORY	1.349,95	1.129,64

TECHNICAL SPECIFICATIONS

PRODUCT TYPE
Rug

ENVIRONMENT
Indoor

DIMENSIONS

Small
W: 170 cm / 66,9"
L: 200 cm / 78,7"

Large
W: 200 cm / 78,7"
L: 300 cm / 118,1"

WEIGHT
Small: 14,3 kg / 31,5 lb
Large: 25,2 kg / 55,6 lb

PRODUCTION PROCESS
The rug is hand woven with undyed natural wool and cotton edges

MATERIALS
Wool, cotton, 4200 GSM

COLOURS
Grey
Ivory

COLOUR CODE
Natural, undyed beige.
Natural, undyed ivory.

GLOSS
N / A

TEST
N / A

CERTIFICATIONS
BS5287, BS4790

PACKAGING TYPE
Plastic-wrapped bale.

PACKAGING MEASUREMENTS (L x W)

Small
170 cm x 20 cm x 20 cm / 67" x 7,8" x 7,8"

Large
200 cm x 25 cm x 25 cm / 78,7" x 9,8" x 9,8"

MATERIALS & MAINTENANCE
Please see page 486 for materials and care and maintenance instructions.

GRAVEL RUG, SMALL

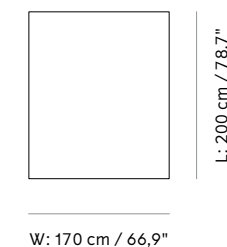

GRAVEL RUG, LARGE

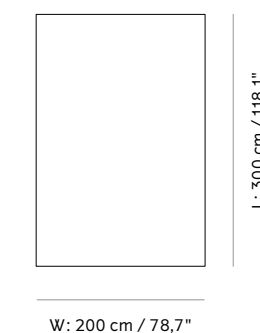

Nimbus Mirror

BY KRØYER-SÆTTER-LASSEN

A glass mirror set on MDF with circular or rectangular bronzed brass frame and decorative screws.

Nimbus Mirror, Ø60, Polished Brass, by Krøyer-Sætter-Lassen
 Nimbus Mirror, Ø60, Bronzed Brass, by Krøyer-Sætter-Lassen
 Nimbus Mirror, Ø110, Polished Brass, by Krøyer-Sætter-Lassen
 Nimbus Mirror, Rectangular, Bronzed Brass, by Krøyer-Sætter-Lassen
 Gravel Rug, Ivory, by Nina Bruun
 Androgyne Lounge Table, by Danielle Siggerud
 Reverse Lamp, by Aleksandar Lazic



PRODUCT OPTIONS

Ø60



Polished Brass
8030839



Bronzed Brass
8030859

Ø110



Polished Brass
8031839



Bronzed Brass
8031859

RECTANGULAR



Polished Brass
8032839



Bronzed Brass
8032859

Nimbus Mirror

BY KRØYER-SÆTTER-LASSEN

STOCK OPTIONS — PRICES IN EUR *Selected combinations up to 2 weeks delivery time.*

SKU	VARIANT	INCL. VAT	EXCL. VAT
8030839	NIMBUS MIRROR Ø60, POLISHED BRASS	549,95	460,20
8030859	NIMBUS MIRROR Ø60, BRONZED BRASS	549,95	460,20
8031839	NIMBUS MIRROR Ø110, POLISHED BRASS	999,95	836,76
8031859	NIMBUS MIRROR Ø110, BRONZED BRASS	999,95	836,76
8032839	NIMBUS MIRROR RECTANGULAR, POLISHED BRASS	999,95	836,76
8032859	NIMBUS MIRROR RECTANGULAR, BRONZED BRASS	999,95	836,76

TECHNICAL SPECIFICATIONS

PRODUCT TYPE
Mirror

ENVIRONMENT
Indoor

DIMENSIONS

Ø60
Ø: 60 cm / 23,6"
D: 2,2 cm / 0,9"

Ø110
Ø: 110 cm / 43,3"
D: 2,2 cm / 0,9"

Rectangular
H: 158,4 cm / 62,4"
W: 53,4 cm / 21"
D: 2,2 cm / 0,9"

PRODUCTION PROCESS
The solid brass frame is untreated and will tarnish over time.

Ø60

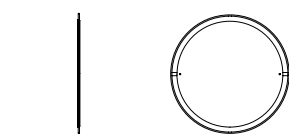

D: 2,1 cm / 0,8" Ø: 60 cm / 23,6"

COLOUR
Polished brass
Bronzed brass

GLOSS
N / A

MATERIALS

Polished, lacquered brass, cut glass mirror and painted MDF or bronzed brass, cut glass mirror, painted MDF and felt.

WEIGHT
Ø60: 8,1 kg / 17,9 lb
Ø110: 27 kg / 59,5 lb
Rectangular: 24,5 kg / 54 lb

TEST
ISTA 1A

Ø110

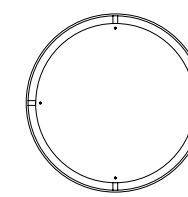

Ø: 110 cm / 43,3"

CERTIFICATIONS
TSCA title VI compliant

PACKAGING TYPE
Brown box

PACKAGING MEASUREMENTS (H x W x D)

Ø60
17 cm x 68 cm x 68 cm / 6,7" x 26,8" x 26,8"

Ø110
13,5 cm x 127 cm x 127 cm / 5,3" x 50" x 50"

Rectangular
19,5 cm x 67 cm x 171 cm / 7,7" x 26,42 x 67,3"

MATERIALS & MAINTENANCE
Please see page 486 for materials and care and maintenance instructions.

RECTANGULAR

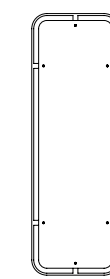

W: 53,4 cm / 21"

H: 158,4 cm / 62,4"

Darkly Mirror

BY NICK ROSS

Circular glass mirror with brushed brass frame. Available in three sizes.

PRODUCT OPTIONS

SMALL



Brushed Brass
8011839

MEDIUM



Brushed Brass
8010839

LARGE



Brushed Brass
8012839

Darkly Mirror, Large, by Nick Ross
Darkly Mirror, Medium, by Nick Ross
Afteroom Dining Chairs, Black Steel / Black Painted Plywood, by Afteroom



Darkly Mirror

BY NICK ROSS

STOCK OPTIONS — PRICES IN EUR

Selected combinations up to 2 weeks delivery time.

SKU	VARIANT	INCL. VAT	EXCL. VAT
8011839	DARKLY, MIRROR, S, BRUSHED BRASS	269,95	225,89
8010839	DARKLY, MIRROR, M, BRUSHED BRASS	399,95	334,68
8012839	DARKLY, MIRROR, L, BRUSHED BRASS	949,95	794,92

TECHNICAL SPECIFICATIONS

PRODUCT TYPE
Mirror

PRODUCTION PROCESS
The base is made by solid brass. The material is non treated and will oxidize over time. To maintain a shiny appearance, use a mild metal polish and a soft cloth.

DIMENSIONS

Small
Ø: 20 cm / 7,9"
D: 6,2 cm / 2,4"

Medium
Ø: 40 cm / 15,7"
D: 12 cm / 4,7"

Large:
Ø: 60 cm / 23,6"
D: 18,6 cm / 7,3"

WEIGHT
Small: 0,8 kg / 1,8 lb
Medium: 2,5 kg / 5,5 lb
Large: 6,3 kg / 13,9 lb

MATERIALS
Solid brass and glass mirror

COLOURS
Brushed brass

PACKAGING TYPE
Gift box

PACKAGING MEASUREMENTS (H x W x D)

Small
25 cm x 25,5 cm x 10 cm / 9,8" x 10" x 3,9"

Medium
48,5 cm x 47,5 cm x 19,5 cm / 19,1" x 18,7" x 7,7"

Large
68,5 cm x 67 cm x 26 cm / 27" x 26,4" x 10,2"

MATERIALS & MAINTENANCE
Please see page 486 for materials and care and maintenance instructions.

SMALL

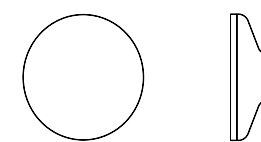

Ø: 20 cm / 7,9" D: 6,2 cm / 2,4"

MEDIUM

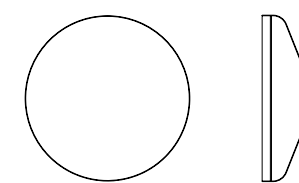

Ø: 40 cm / 15,7" D: 12 cm / 4,7"

LARGE

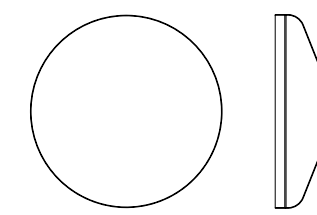

Ø: 60 cm / 23,6" D: 18,6 cm / 7,3"

Pedal Bins, 4L/7L/11L

BY NORM ARCHITECTS

Powder coated steel bin with solar-brushed, soft close stainless steel lid, removable plastic liner and easy-to-clean body. Available in five sizes.

PRODUCT OPTIONS

POWDER COATED STEEL BASE



WHITE STEEL



BLACK STEEL

PEDAL BIN TOP



SOLAR BRUSHED

Pedal Bin, 7L, White, by Norm Architects



Pedal Bins, 4L/7L/11L

BY NORM ARCHITECTS

STOCK OPTIONS — PRICES IN EUR

Selected combinations up to 2 weeks delivery time.

SKU	VARIANT	INCL. VAT	EXCL. VAT
7604539	PEDAL BIN, 4 L, BLACK STEEL	169,95	142,21
7604639	PEDAL BIN, 4 L, WHITE STEEL	169,95	142,21
7607539	PEDAL BIN, 7 L, BLACK STEEL	199,95	167,32
7607639	PEDAL BIN, 7 L, WHITE STEEL	199,95	167,32
7611539	PEDAL BIN, 11 L, BLACK STEEL	269,95	225,89
7611639	PEDAL BIN, 11 L, WHITE STEEL	269,95	225,89

TECHNICAL SPECIFICATIONS

PRODUCT TYPE

Pedal bin

WEIGHT

4 L: 3,5 kg / 7,7 lb
7 L: 4 kg / 8,8 lb
11 L: 5,4 kg / 11,9 lb

PACKAGING MEASUREMENTS (H x W x D)

4 L
39,5 cm x 27,5 cm x 31 cm / 15,6" x 10,8" x 12,2"

PRODUCTION PROCESS

Rolled steel with welded deep drawn base and lid.

MATERIALS

Stainless steel, powder coated steel, plastic, silicone.

7 L
44,5 cm x 27,5 cm x 31 cm / 17,5" x 10,8" x 12,2"

DIMENSIONS

4 L
H: 34 cm / 13,4"
Ø: 23,5 cm / 9,25"

7 L
H: 39 cm / 13,4"
Ø: 23,5 cm / 9,25"

11 L
H: 43 cm / 16,9"
Ø: 27 cm / 10,6"

COLOURS

Black (RAL 9005), matte
White (RAL 9016), shiny (Gloss 95)

11 L
54 cm x 34,5 cm x 35 cm / 21,3" x 13,6" x 13,8"

MATERIALS & MAINTENANCE

Please see page 486 for materials and care and maintenance instructions.

PACKAGING TYPE

Gift box

BIN 4 L

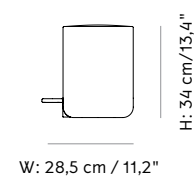

W: 28,5 cm / 11,2"

BIN 7 L

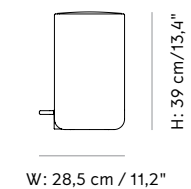

W: 28,5 cm / 11,2"

BIN 11 L

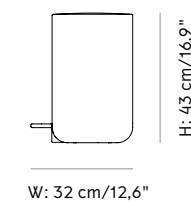

W: 32 cm / 12,6"

Pedal Bins, 20L/30L

BY NORM ARCHITECTS

Powder coated steel bin with solar-brushed, soft close stainless steel lid, removable plastic liner and easy-to-clean body. Available in five sizes.

PRODUCT OPTIONS

POWDER COATED STEEL BASE



WHITE STEEL



BLACK STEEL

PEDAL BIN TOP



STAINLESS STEEL

Pedal Bin, 7L, White, by Norm Architects



Pedal Bins, 20L/30L

BY NORM ARCHITECTS

STOCK OPTIONS — PRICES IN EUR

Selected combinations up to 2 weeks delivery time.

SKU	VARIANT	INCL. VAT	EXCL. VAT
7620539	PEDAL BIN, 20 L, BLACK STEEL	329,95	276,10
7620639	PEDAL BIN, 20 L, WHITE STEEL	329,95	276,10
7630539	PEDAL BIN, 30 L, BLACK STEEL	349,95	292,84
7630639	PEDAL BIN, 30 L, WHITE STEEL	349,95	292,84

TECHNICAL SPECIFICATIONS

PRODUCT TYPE
Pedal bin

PRODUCTION PROCESS
Rolled steel with welded deep drawn base and lid.

DIMENSIONS

20 L
H: 63 cm / 24,8"
Ø: 30,5 cm / 12"

30 L
H: 68,5 cm / 27"
Ø: 33,5 cm / 13,2"

WEIGHT
20 L: 7,7 kg / 17 lb
30 L: 8,9 kg / 19,6 lb

MATERIALS
Stainless steel, powder coated steel, plastic, silicone.

COLOURS
Black (RAL 9005), matte
White (RAL 9016), shiny (Gloss 95)

PACKAGING TYPE
Gift box

PACKAGING MEASUREMENTS (H x W x D)

20 L
70,5 cm x 37 cm x 37,5 cm / 27,8" x 14,62 x 14,6"

30 L
74 cm x 37,5 cm x 38 cm / 29,1" x 14,8" x 14,8"

MATERIALS & MAINTENANCE
Please see page 486 for materials and care and maintenance instructions.

BIN 20 L

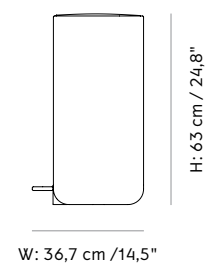

BIN 30 L

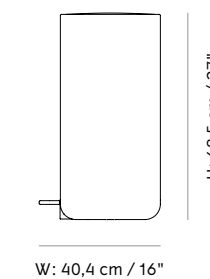

2.

Lighting

Bank Pendant

BY NORM ARCHITECTS

Mouth-blown opal or smoke glass pendant with black anodised aluminium fittings.

PRODUCT OPTIONS



Opal
1860629



Smoke
1860949

Bank Pendant, Black / Smoke Glass, by Norm Architects
Bank Pendant, Black / Opal Glass, by Norm Architects



Bank Pendant

BY NORM ARCHITECTS

STOCK OPTIONS — PRICES IN EUR *Selected combinations up to 2 weeks delivery time.*

SKU	VARIANT	INCL. VAT	EXCL. VAT
1860629	BANK PENDANT, OPAL GLASS	349,95	292,84
1860949	BANK PENDANT, SMOKE GLASS	349,95	292,84

TECHNICAL SPECIFICATIONS

PRODUCT TYPE
Pendant

ENVIRONMENT
Indoor

DIMENSIONS
H: 30 cm / 11,8"
Ø: 35 cm / 13,8"

PRODUCTION PROCESS
Both arm and connector are made from aluminium.
The shade is made from mouth-blown glass.

COLOURS
Black (RAL 9005) / Opal
Black (RAL 9005) / Smoke

MATERIALS
Anodized aluminium and glass.

WEIGHT
4,9 - 5,5 kg / 10,8 - 12,1 lb
Weight may vary due to mouth-blown glass.

VOLTAGE
220 V / 110 V

LIGHT SOURCE & ENERGY EFFICIENCY CLASS
CE (E27) / US (E26) (Not included)
MAX 60 W
A++, A+, A, B, C, D

LIGHT SPECIFICATION
Lumen, Kelvin and Ra value depends on bulb used.

DIMMER
No. The lamp can be connected to a dimmer system.

CANOPY
Yes, ABS, black
Ø: 11,5 cm / 4,5"
H: 3,8 cm / 1,5"

CORD MATERIAL AND COLOUR
Black textile / PVC and stainless steel wire.

CORD LENGTH
400 cm / 157,5"

CLASSIFICATION
IP20

CERTIFICATIONS
CE certified, tests can be obtained upon request.

PACKAGING TYPE
Gift box

PACKAGING MEASUREMENTS (H x W x D)
40,5 cm x 40 cm x 41,5 cm / 15,9" x 15,7" x 15,9"

MATERIALS & MAINTENANCE
Please see page 486 for materials and care and maintenance instructions.

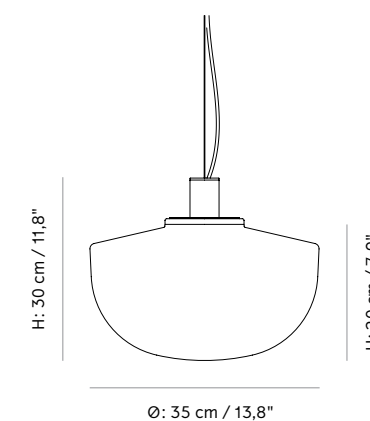

Franklin Chandelier

BY SØREN ROSE STUDIO

Brass or black powder coated steel chandelier with four angled arms, bare bulb and black textile cord.

Franklin Chandelier, Brass, by Søren Rose Studio

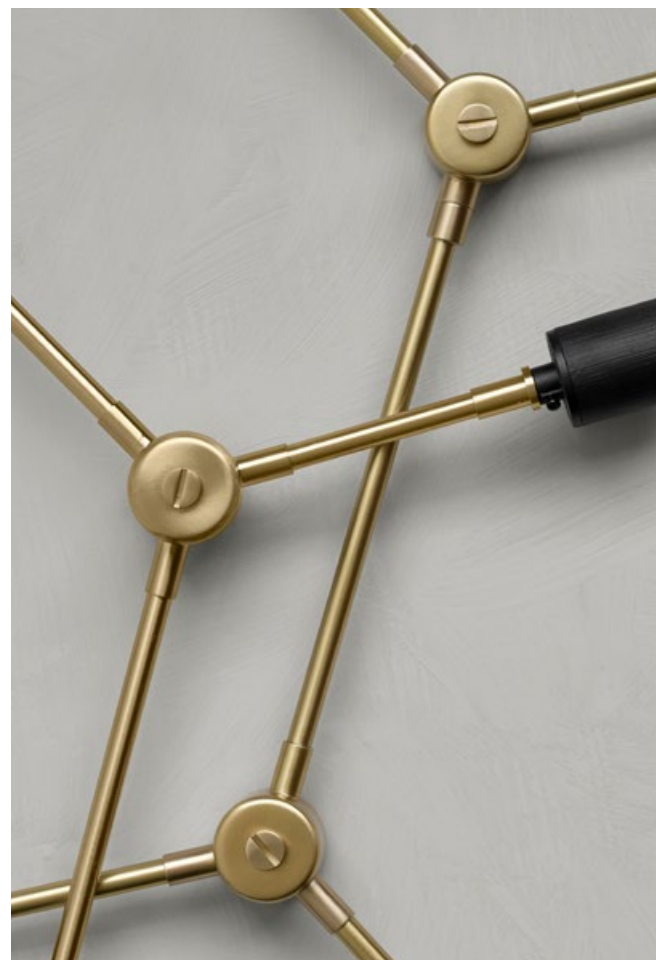

PRODUCT OPTIONS



Black
1920539



Brass
1920839

Franklin Chandelier

BY SØREN ROSE STUDIO

STOCK OPTIONS — PRICES IN EUR *Selected combinations up to 2 weeks delivery time.*

SKU	VARIANT	INCL. VAT	EXCL. VAT
1920539	FRANKLIN CHANDELIER, BLACK STEEL	449,95	376,52
1920839	FRANKLIN CHANDELIER, BRASS	599,95	502,04

TECHNICAL SPECIFICATIONS

PRODUCT TYPE Chandelier	WEIGHT 1,1 kg / 2,4 lb	CORD MATERIAL AND COLOUR Textile, black.
ENVIRONMENT Indoor	VOLTAGE 220 V / 110 V	CORD LENGTH 500 cm / 196,9"
DIMENSIONS H: 56 cm / 22" Ø: 56 cm / 22"	LIGHT SOURCE & ENERGY EFFICIENCY CLASS CE (E27) / US (E26) (Not included) MAX 60 W A++, A+, A, B, C, D	CLASSIFICATION IP20
PRODUCTION PROCESS The arms and connection parts are made from solid brass or steel rod, the socket is painted ceramic. The brass is thinly lacquered to keep the luster of the brass material.	LIGHT SPECIFICATION Lumen, Kelvin and Ra value depends on which bulb is used.	CERTIFICATIONS CE certified, tests can be obtained upon request.
COLOURS Brass Black (RAL 9005)	DIMMER No. The lamp can be connected to a dimmer system.	PACKAGING TYPE Gift box
MATERIALS Powder coated steel (fine texture, matte finish) or solid brass (matte polished).	CANOPY Yes, powder coated steel, black Ø: 12 cm / 4,7" H: 2,5 cm / 0,9"	PACKAGING MEASUREMENTS (H x W x D) 54,7 cm x 70 cm x 8,2 cm / 21,5" x 27,5" x 3,2"
		MATERIALS & MAINTENANCE Please see page 486 for materials and care and maintenance instructions.

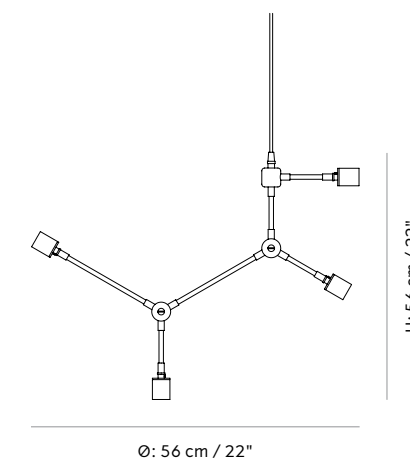

Harrison Chandelier

BY SØREN ROSE STUDIO

Brass or black powder coated steel chandelier with five angled arms, bare bulbs and black textile cord.

Harrison Chandelier, Brass, by Søren Rose Studio
Globe Bulb, by Menu



PRODUCT OPTIONS



Black
1970539



Brass
1970839

Harrison Chandelier

BY SØREN ROSE STUDIO

STOCK OPTIONS — PRICES IN EUR *Selected combinations up to 2 weeks delivery time.*

SKU	VARIANT	INCL. VAT	EXCL. VAT
1970539	HARRISON CHANDELIER, BLACK STEEL	599,95	502,04
1970839	HARRISON CHANDELIER, BRASS	749,95	627,56

TECHNICAL SPECIFICATIONS

PRODUCT TYPE Chandelier	WEIGHT 2 kg / 4,4 lb	CORD MATERIAL AND COLOUR Textile, black.
ENVIRONMENT Indoor	VOLTAGE 220 V / 110 V	CORD LENGTH 500 cm / 196.8"
DIMENSIONS H: 85 cm / 33,5" W / Ø: 50 cm / 19,7"	LIGHT SOURCE & ENERGY EFFICIENCY CLASS CE (E27) / US (E26) (Not included) MAX 60 W A++, A+, A, B, C, D	CLASSIFICATION IP20
PRODUCTION PROCESS The arms and connection parts are made from solid brass or steel rod, the socket is painted ceramic. The brass is thinly lacquered to keep the luster of the brass material.	LIGHT SPECIFICATION Lumen, Kelvin and Ra value depends on which bulb is used.	CERTIFICATIONS CE certified, tests can be obtained upon request.
COLOURS Brass Black (RAL 9005)	DIMMER No. The lamp can be connected to a dimmer system.	PACKAGING TYPE Gift box
MATERIALS Powder coated steel (fine texture, matte finish) or solid brass (matte polished).	CANOPY Yes, powder coated steel, black Ø: 12 cm / 4,7" H: 2,5 cm / 0,9"	PACKAGING MEASUREMENTS (H x W x D) 94 cm x 120,5 cm x 8 cm / 37" x 47,4" x 3,1"
		MATERIALS & MAINTENANCE Please see page 486 for materials and care and maintenance instructions.

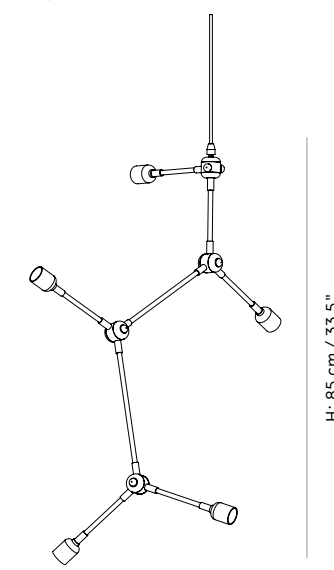

W / Ø: 50 cm / 19,7"

H: 85 cm / 33,5"

Leonard Chandelier

BY SØREN ROSE STUDIO

Brass or powder coated steel chandelier with five angled arms and black textile cord.

Leonard Chandelier, Black, by Søren Rose Studio



PRODUCT OPTIONS



Black
1910539



Brass
1910839

Leonard Chandelier

BY SØREN ROSE STUDIO

STOCK OPTIONS — PRICES IN EUR *Selected combinations up to 2 weeks delivery time.*

SKU	VARIANT	INCL. VAT	EXCL. VAT
1910539	LEONARD CHANDELIER, BLACK STEEL	449,95	376,52
1910839	LEONARD CHANDELIER, BRASS	549,95	460,20

TECHNICAL SPECIFICATIONS

PRODUCT TYPE Chandelier	WEIGHT 1 kg / 2.2 lb	CORD MATERIAL AND COLOUR Textile, black.
ENVIRONMENT Indoor	VOLTAGE 220 V / 110 V	CORD LENGTH 500 cm / 196,9"
DIMENSIONS H: 15 cm / 5,9" Ø: 46 cm / 18,1"	LIGHT SOURCE & ENERGY EFFICIENCY CLASS CE (E27) / US (E26) (Not included) MAX 60 W A++, A+, A, B, C, D	CLASSIFICATION IP20
PRODUCTION PROCESS The arms and connection parts are made from solid brass or steel rod, the socket is painted ceramic. The brass is thinly lacquered to keep the luster of the brass material.	LIGHT SPECIFICATION Lumen, Kelvin and Ra value depends on which bulb is used.	CERTIFICATIONS CE certified, tests can be obtained upon request.
COLOURS Brass Black (RAL 9005)	DIMMER No. The lamp can be connected to a dimmer system.	PACKAGING TYPE Gift box
MATERIALS Powder coated steel (fine texture, matte finish) or solid brass (matte polished).	CANOPY Yes, powder coated steel, black Ø: 12 cm / 4,7" H: 2,5 cm / 1"	PACKAGING MEASUREMENTS (H x W x D) 51,5 cm x 51,7 cm x 18,2 cm / 20,3" x 20,4" x 7,2"
		MATERIALS & MAINTENANCE Please see page 486 for materials and care and maintenance instructions.

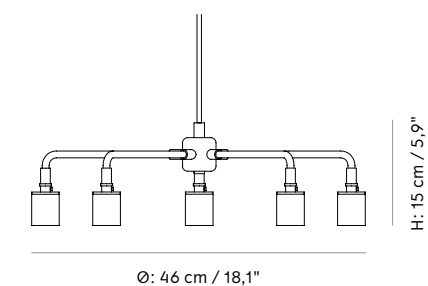

Chambers Chandelier Ø76

BY SØREN ROSE STUDIO

Brass or powder coated steel chandelier with five angled arms and black textile cord. Available in two sizes.

Chambers Chandelier, Ø76, Brass, by Søren Rose Studio
Globe Bulb, by Menu

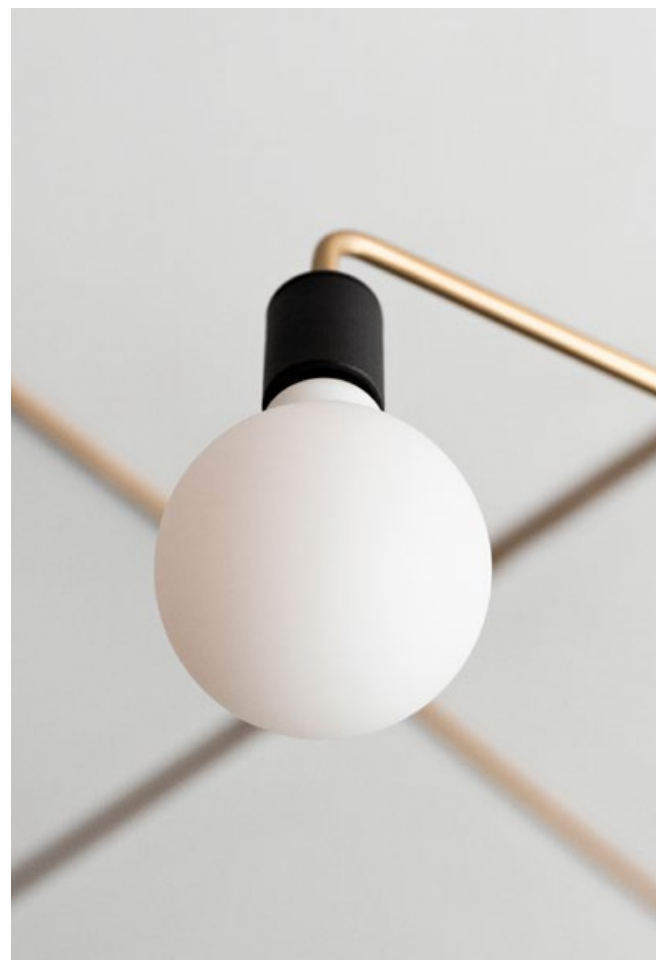

PRODUCT OPTIONS



Black
1991539



Brass
1991839

Chambers Chandelier Ø76

BY SØREN ROSE STUDIO

STOCK OPTIONS — PRICES IN EUR *Selected combinations up to 2 weeks delivery time.*

SKU	VARIANT	INCL. VAT	EXCL. VAT
1991539	CHAMBERS CHANDELIER, 76, BLACK STEEL	549,95	460,20
1991839	CHAMBERS CHANDELIER, 76, BRASS	599,95	502,04

TECHNICAL SPECIFICATIONS

PRODUCT TYPE Chandelier	WEIGHT 1,45 kg / 3,2 lb	CORD MATERIAL AND COLOUR Textile, black.
ENVIRONMENT Indoor	VOLTAGE 220 V / 110 V	CORD LENGTH 500 cm / 196,9"
DIMENSIONS H: 15 cm / 5,9" Ø: 76 cm / 29,9"	LIGHT SOURCE & ENERGY EFFICIENCY CLASS CE (E27) / US (E26) (Not included) MAX 60 W A++, A+, A, B, C, D	CLASSIFICATION IP20
COLOURS Brass Black (RAL 9005)	LIGHT SPECIFICATION Lumen, Kelvin and Ra value depends on which bulb is used.	CERTIFICATIONS CE certified, tests can be obtained upon request.
PRODUCTION PROCESS The arms and connector are made from bent solid brass or steel rod. The centre fitting is cast in brass and the sockets are painted ceramic. Brass is lightly varnished to maintain the lustre of the material.	DIMMER No. The lamp can be connected to a dimmer system.	PACKAGING TYPE Brown box
MATERIALS Powder coated steel (fine texture, matte) or solid brass (matte polished).	CANOPY Yes, powder coated steel, black Ø: 12 cm / 4,7" H: 2,5 cm / 0,9"	PACKAGING MEASUREMENTS (H x W x D) 85 cm x 81 cm x 21 cm / 33,4" x 31,8" x 8,2"
		MATERIALS & MAINTENANCE Please see page 486 for materials and care and maintenance instructions.

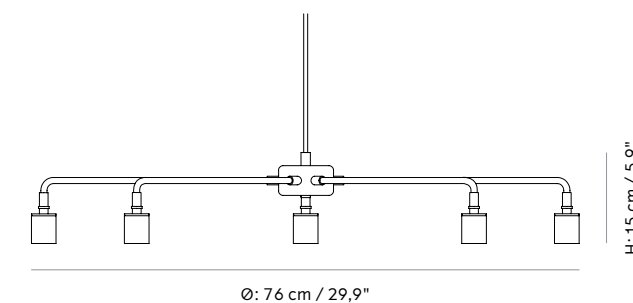

Chambers Chandelier Ø96

BY SØREN ROSE STUDIO

Brass or powder coated steel chandelier with five angled arms and black textile cord. Available in two sizes.

Chambers Chandelier, Ø96, Brass, by Søren Rose Studio



PRODUCT OPTIONS



Black
1990539



Brass
1990839

Chambers Chandelier Ø96

BY SØREN ROSE STUDIO

STOCK OPTIONS — PRICES IN EUR *Selected combinations up to 2 weeks delivery time.*

SKU	VARIANT	INCL. VAT	EXCL. VAT
1990539	CHAMBERS CHANDELIER, 96, BLACK	599,95	502,04
1990839	CHAMBERS CHANDELIER, 96, BRASS	669,95	560,61

TECHNICAL SPECIFICATIONS

PRODUCT TYPE Chandelier	WEIGHT 1,55 kg / 3,4 lb	CORD MATERIAL AND COLOUR Textile, black.
ENVIRONMENT Indoor	VOLTAGE 220 V / 110 V	CORD LENGTH 500 cm / 196,9"
DIMENSIONS H: 15 cm / 5,9" Ø: 96 cm / 37,8"	LIGHT SOURCE & ENERGY EFFICIENCY CLASS CE (E27) / US (E26) (Not included) MAX 60 W A++, A+, A, B, C, D	CLASSIFICATION IP20
COLOURS Brass Black (RAL 9005)	LIGHT SPECIFICATION Lumen, Kelvin and Ra value depends on which bulb is used.	CERTIFICATIONS CE certified, tests can be obtained upon request.
PRODUCTION PROCESS The arms and connector are made from bent solid brass or steel rods. The centre fitting is made of sand-cast brass and the sockets from painted ceramic. The brass is lightly varnished to maintain its natural lustre.	DIMMER No. The lamp can be connected to a dimmer system.	PACKAGING TYPE Gift box
MATERIALS Powder coated steel (fine texture, matte) or solid brass (matte polished).	CANOPY Yes, powder coated steel, black Ø: 12 cm / 4,7" H: 2,5 cm / 0,9"	PACKAGING MEASUREMENTS (H x W x D) 102,5 cm x 97 cm x 21 cm / 40.3" x 38" x 8,2"
		MATERIALS & MAINTENANCE Please see page 486 for materials and care and maintenance instructions.

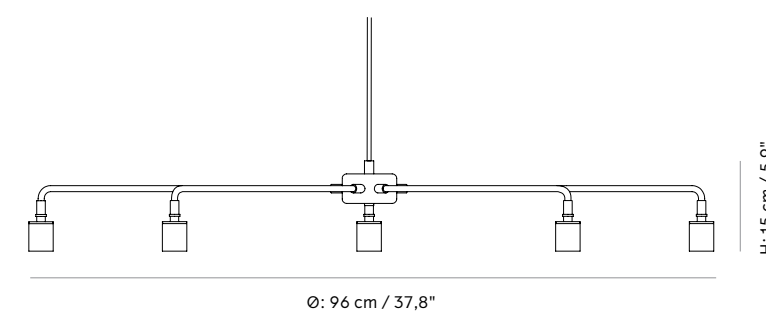

Hubert Pendant Ø24

BY SØREN ROSE STUDIO

Powder coated steel or brass shade suspended from textile cord with an elongated socket. Available in two sizes.

PRODUCT OPTIONS



Black / Brass
1935539



Black / Bronzed Brass
1935859



Ivory / Bronzed Brass
1935649

Hubert Pendant, Ø24, Black / Bronzed Brass, by Soren Rose Studio



Hubert Pendant Ø24

BY SØREN ROSE STUDIO

STOCK OPTIONS — PRICES IN EUR *Selected combinations up to 2 weeks delivery time.*

SKU	VARIANT	INCL. VAT	EXCL. VAT
1935539	HUBERT PENDANT, Ø24, BLACK / BRASS	299,95	251,00
1935859	HUBERT PENDANT, Ø24, BLACK / BRONZED BRASS	299,95	251,00
1935649	HUBERT PENDANT, Ø24, IVORY / BRONZED BRASS	299,95	251,00

TECHNICAL SPECIFICATIONS

PRODUCT TYPE Pendant	WEIGHT 0,8 kg / 1,8 lb	CORD MATERIAL AND COLOUR Textile, black.
ENVIRONMENT Indoor	VOLTAGE 220 – 240 V / 110 – 130 V	CORD LENGTH 300 cm / 118,1"
DIMENSIONS H: 18 cm / 7,1" Ø: 24 cm / 9,4"	LIGHT SOURCE & ENERGY EFFICIENCY CLASS CE (E27) / US (E26) (Not included) MAX 60 W A++, A+, A, B, C, D	CLASSIFICATION IP20
PRODUCTION PROCESS The shade is made using the deep drawing technique. All sockets are cast in brass.	LIGHT SPECIFICATION Lumen, Kelvin and Ra value depends on which bulb is used.	CERTIFICATIONS CE certified, tests can be obtained upon request.
COLOURS Black (RAL 9005) / Brass Black (RAL 9005) / Bronzed brass Ivory (NCS 1002-Y50R) / Bronzed brass	DIMMER No. The lamp can be connected to a dimmer system.	PACKAGING TYPE Gift box
MATERIALS Powder coated brass or steel, solid brass (Black: textured and matte. Ivory: smooth and glossy).	CANOPY Yes, powder coated steel, black. Ø: 12 cm / 4,7" H: 2,5 cm / 0,9"	PACKAGING MEASUREMENTS (H x W x D) 31,6 cm x 33,9 cm x 28,9 cm / 12,4" x 13,3" x 11,4"
		MATERIALS & MAINTENANCE Please see page 486 for materials and care and maintenance instructions.

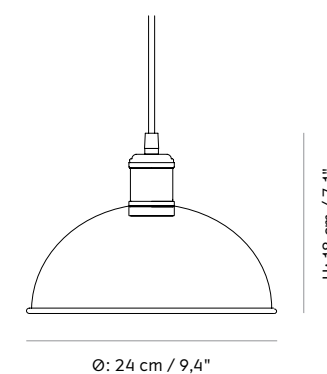

Hubert Pendant Ø45

BY SØREN ROSE STUDIO

Powder coated steel shade suspended from textile cord with an elongated socket. Available in two sizes.

PRODUCT OPTIONS



Black / Bronzed Brass
1936859



Ivory / Bronzed Brass
1936649

Hubert Pendant, Ø45, Ivory / Bronzed Brass, by Søren Rose Studio



Hubert Pendant Ø45

BY SØREN ROSE STUDIO

STOCK OPTIONS — PRICES IN EUR *Selected combinations up to 2 weeks delivery time.*

SKU	VARIANT	INCL. VAT	EXCL. VAT
1936859	HUBERT PENDANT, Ø45, BLACK / BRONZED BRASS	299,95	251,00
1936649	HUBERT PENDANT, Ø45, IVORY / BRONZED BRASS	299,95	251,00

TECHNICAL SPECIFICATIONS

PRODUCT TYPE
Pendant

ENVIRONMENT
Indoor

DIMENSIONS
H: 21,5 cm / 8,5"
Ø: 45 cm / 17,7"

PRODUCTION PROCESS
The shade is made using the deep drawing technique. All sockets are cast in brass.

COLOURS
Ivory (NCS 1002-Y50R) / Bronzed brass
Black (RAL 9005) / Bronzed brass

MATERIALS
Powder coated brass or steel, solid brass (Black: textured and matte. Ivory: smooth and glossy).

WEIGHT
2,4 kg / 5,3 lb

VOLTAGE
220 – 240 V / 110 – 130 V

LIGHT SOURCE & ENERGY EFFICIENCY CLASS
CE (E27) / US (E26) (Not included)
MAX 60 W
A++, A+, A, B, C, D

LIGHT SPECIFICATION
Lumen, Kelvin and Ra value depends on which bulb is used.

DIMMER
No. The lamp can be connected to a dimmer system.

CANOPY
Yes, powder coated steel, black.
Ø: 12 cm / 4,7"
H: 2,5 cm / 0,9"

CORD MATERIAL AND COLOUR
Textile, black.

CORD LENGTH
400 cm / 157,5"

CLASSIFICATION
IP20

CERTIFICATIONS
CE certified, tests can be obtained upon request.

PACKAGING TYPE
Gift box

PACKAGING MEASUREMENTS (H x W x D)
51,5 cm x 51,5 cm x 20,5 cm / 20,3" x 20,3" x 8,1"

MATERIALS & MAINTENANCE
Please see page 486 for materials and care and maintenance instructions.

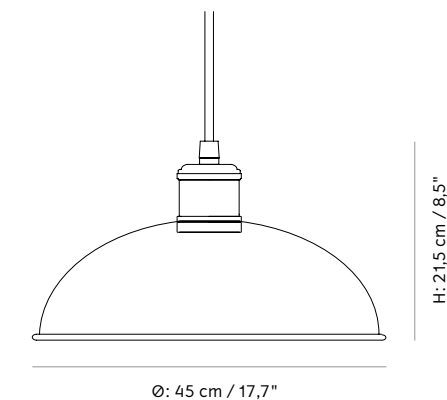

Hubert Suspension Frame

BY SØREN ROSE STUDIO

Powder coated steel shades and suspension frame with textile cord and steel wire

Hubert Suspension Frame, Ivory / Bronzed Brass, by Soren Rose Studio



PRODUCT OPTIONS



Black / Bronzed Brass
1937859



Ivory / Bronzed Brass
1937649

Hubert Suspension Frame

BY SØREN ROSE STUDIO

STOCK OPTIONS — PRICES IN EUR *Selected combinations up to 2 weeks delivery time.*

SKU	VARIANT	INCL. VAT	EXCL. VAT
1937859	HUBERT SUSPENSION FRAME, BLACK / BRONZED BRASS	699,95	585,72
1937649	HUBERT SUSPENSION FRAME, IVORY / BRONZED BRASS	699,95	585,72

TECHNICAL SPECIFICATIONS

PRODUCT TYPE
Suspension frame

WEIGHT
3,6 kg / 8,0 lb

CORD MATERIAL AND COLOUR
Textile, black.

ENVIRONMENT
Indoor

VOLTAGE
220 – 240 V / 110 – 130 V

CORD LENGTH
400 cm / 157,5"

DIMENSIONS
H: 25 cm / 9,8"
D: 24 cm / 9,4"
W: 146 cm / 57,5"

LIGHT SOURCE & ENERGY EFFICIENCY CLASS
CE (E27) / US (E26) (Not included)
MAX 60 W
A++, A+, A, B, C, D

CLASSIFICATION
IP20

PRODUCTION PROCESS
The shade is made using the deep drawing technique. The suspension bar is made from welded steel and all sockets are cast in brass.

LIGHT SPECIFICATION
Lumen, Kelvin and Ra value depends on which bulb is used.

CERTIFICATIONS
CE certified, tests can be obtained upon request.

COLOURS
Ivory (NCS 1002-Y50R) / Bronzed brass
Black (RAL 9005) / Bronzed brass

DIMMER
No. The lamp can be connected to a dimmer system.

PACKAGING TYPE
Gift box

MATERIALS
Powder coated brass or steel, solid brass (Black: textured and matte. Ivory: smooth and glossy).

CANOPY
Yes, powder coated steel, black.
Ø: 12 cm / 4,7"
H: 2,5 cm / 0,9"

PACKAGING MEASUREMENTS (H x W x D)
18,5 cm x 153 cm x 41 cm / 7,3" x 60,2" x 16,1"

MATERIALS & MAINTENANCE
Please see page 486 for materials and care and maintenance instructions.

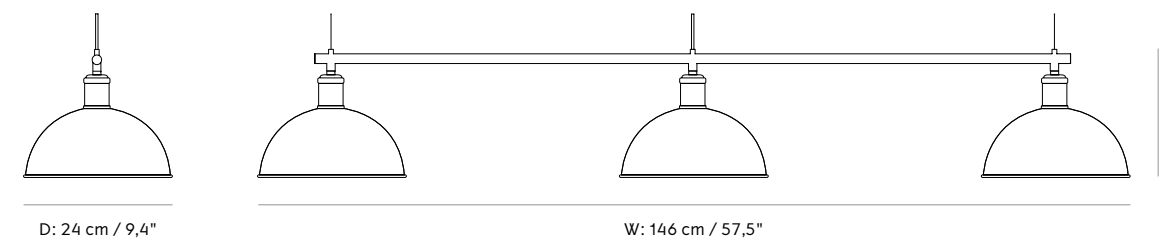

Walker Ceiling/Wall Lamp

BY SØREN ROSE STUDIO

Powder coated brass or opal glass shade with brass base.

PRODUCT OPTIONS



Opal
1944629



Black / Brass
1945539

Walker Ceiling / Wall Lamp, Opal / Bronzed Brass, by Søren Rose Studio



Walker Ceiling/Wall Lamp

BY SØREN ROSE STUDIO

STOCK OPTIONS — PRICES IN EUR *Selected combinations up to 2 weeks delivery time.*

SKU	VARIANT	INCL. VAT	EXCL. VAT
1944629	WALKER CEILING / WALL LAMP, OPAL	269,95	225,89
1945539	WALKER CEILING / WALL LAMP, BLACK / BRASS	299,95	251,00

TECHNICAL SPECIFICATIONS

PRODUCT TYPE
Ceiling / Wall lamp

ENVIRONMENT
Indoor

DIMENSIONS
H: 28 cm / 11"
W: 16 cm / 6,3"
D: 40 cm or 22 cm / 15,7" or 8,6"

PRODUCTION PROCESS

Black/brass version:
The arm is made from solid brass rods with sand-cast brass fittings. The base is made of drawn brass. The shade is made from spun solid brass with a powder coated surface. The brass is varnished to maintain its natural lustre.

Opal version:
The arm is made of bronze-plated solid brass rods with sand-cast brass fittings. The base is made from drawn brass. The shade is made from mouth-blown opal glass.

COLOURS
Black (RAL 9005) / Polished brass
Opal / Bronzed brass

MATERIALS
Powder coated steel and solid brass (fine texture, matte) glass, textile, PVC.

WEIGHT
Black: 1 kg / 2,2 lb
Opal: 1,35 kg / 2,9 lb

VOLTAGE
220 V / 110 - 130 V

LIGHT SOURCE & ENERGY EFFICIENCY CLASS
CE (E27) / US (E26) (Not included)
MAX 60 W
A++, A+, A, B, C, D

LIGHT SPECIFICATION
Lumen, Kelvin and Ra value depends on which bulb is used.

DIMMER
Yes, on cord.

CANOPY
Yes (as base), in solid brass.
Ø: 12 cm / 4,7"
H: 2 cm / 0,7"

CORD MATERIAL AND COLOUR
Textile, black, black plug.

CORD LENGTH
200 cm / 78,8"
The cord can be shortened and rewired.

CLASSIFICATION
IP20

CERTIFICATIONS
CE certified, tests can be obtained upon request.

PACKAGING TYPE
Gift box

PACKAGING MEASUREMENTS (H x W x D)
34,1 cm x 27,8 cm x 22,4 cm / 13,4" x 10,9" x 8,8"

MATERIALS & MAINTENANCE
Please see page 486 for materials and care and maintenance instructions.

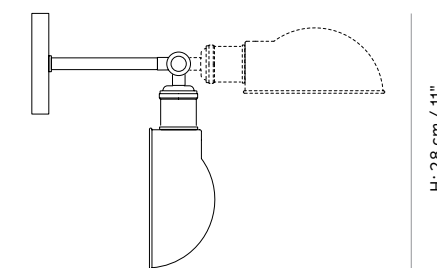

D: 40 cm or 22 cm / 15,7" or 8,6"

H: 28 cm / 11"

Hudson Ceiling/Wall Lamp

BY SØREN ROSE STUDIO

Adjustable powder coated brass or bronzed brass lamp with textile cord.

PRODUCT OPTIONS



Black / Brass
1946539



Black / Bronzed Brass
1946859

Hudson Ceiling / Wall Lamp, Black / Bronzed Brass, by Søren Rose Studio



Hudson Ceiling/Wall Lamp

BY SØREN ROSE STUDIO

STOCK OPTIONS — PRICES IN EUR *Selected combinations up to 2 weeks delivery time.*

SKU	VARIANT	INCL. VAT	EXCL. VAT
1946539	HUDSON CEILING / WALL LAMP, BLACK / BRASS	349,95	292,84
1946859	HUDSON CEILING / WALL LAMP, BLACK / BRONZED BRASS	349,95	292,84

TECHNICAL SPECIFICATIONS

PRODUCT TYPE Ceiling / Wall lamp	WEIGHT 1,3 kg / 3,0 lb	CORD MATERIAL AND COLOUR PVC, black.
ENVIRONMENT Indoor	VOLTAGE 220 V / 110 V	CORD LENGTH 20 cm / 7,9" Hard-wired
DIMENSIONS H: 92,3 cm / 36,4" W: 16 cm / 6,3"	LIGHT SOURCE & ENERGY EFFICIENCY CLASS CE (E27) / US (E26) (Not included) MAX 60 W A++, A+, A, B, C, D	CLASSIFICATION IP20
PRODUCTION PROCESS The arm is made from solid brass rods and sand-cast brass fittings. The base is made of drawn brass. The shade is made from spun, solid brass with a powder coated surface. The brass is lightly varnished to maintain its natural lustre.	LIGHT SPECIFICATION Lumen, Kelvin and Ra value depends on which bulb is used.	CERTIFICATIONS CE certified, tests can be obtained upon request.
COLOURS Black (RAL 9005) / Bronzed brass Black (RAL 9005) / Brass	DIMMER No. The lamp can be connected to a dimmer system.	PACKAGING TYPE Gift box
MATERIALS Powder coated steel and solid brass (fine texture, matte).	CANOPY Yes (as base), in solid brass. Ø: 12 cm / 4,7" H: 2 cm / 0,7"	PACKAGING MEASUREMENTS (H x W x D) 18,4 cm x 97,8 cm x 21,8 cm / 7,2" x 38,5" x 8,6"
		MATERIALS & MAINTENANCE Please see page 486 for materials and care and maintenance instructions.

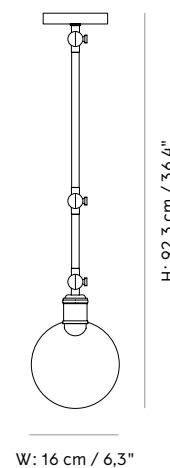

Warren Wall Lamp

BY SØREN ROSE STUDIO

Black powder coated steel or brass angled lamp with textile cord.

PRODUCT OPTIONS



Black
1950539



Brass
1950839

Warren Wall Lamp, Black, by Søren Rose Studio
Globe Bulb, by Menu



Warren Wall Lamp

BY SØREN ROSE STUDIO

STOCK OPTIONS — PRICES IN EUR *Selected combinations up to 2 weeks delivery time.*

SKU	VARIANT	INCL. VAT	EXCL. VAT
1950539	WARREN WALL LAMP, BLACK	269,95	225,89
1950839	WARREN WALL LAMP, BRASS	299,95	251,00

TECHNICAL SPECIFICATIONS

PRODUCT TYPE
Wall lamp

WEIGHT
0,7 kg / 1,54 lb

CORD MATERIAL AND COLOUR
Textile, black, black plug.

ENVIRONMENT
Indoor

VOLTAGE
220 V / 110 – 130 V

CORD LENGTH
200 cm / 78,8"

DIMENSIONS
H: 56 cm / 22"
D: 62 cm / 24,4"

LIGHT SOURCE & ENERGY EFFICIENCY CLASS
CE (E27) / US (E26) (Not included)
MAX 60 W
A++, A+, A, B, C, D

CLASSIFICATION
IP20

PRODUCTION PROCESS
The arm is made from solid brass rods and sand-cast brass fittings. The base is made of drawn brass. The shade is made from spun, solid brass with a powder coated surface. The brass is lightly varnished to maintain its natural lustre.

LIGHT SPECIFICATION
Lumen, Kelvin and Ra value depends on which bulb is used.

CERTIFICATIONS
CE certified, tests can be obtained upon request.

COLOURS
Brass
Black (RAL 9005)

DIMMER
Yes, on cord

PACKAGING TYPE
Gift box

MATERIALS
Powder coated steel and solid brass (fine texture, matte).

CANOPY
Yes (as base), in solid brass or steel.
Ø: 9 cm / 3,5"
H: 1,2 cm / 0,5"

PACKAGING MEASUREMENTS (H x W x D)
31,7 cm x 62,6 cm x 14 cm / 12,5" x 24,6" x 5,5"

MATERIALS & MAINTENANCE
Please see page 486 for materials and care and maintenance instructions.

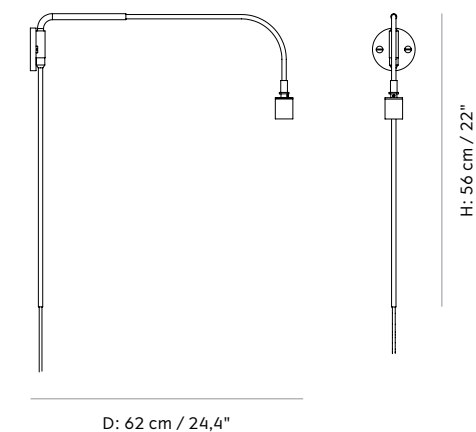

Staple Wall Lamp

BY SØREN ROSE STUDIO

Black powder coated steel or brass wall-mounted lamp with decorative screws and textile cord with dimmer switch.

PRODUCT OPTIONS



Black
1960539



Brass
1960839

Staple Wall Lamp, Black, by Søren Rose Studio
Clear Bulb, Ø12,5, by Menu
Plinth Tall, Calacatta Viola Marble, by Norm Architects



Staple Wall Lamp

BY SØREN ROSE STUDIO

STOCK OPTIONS — PRICES IN EUR *Selected combinations up to 2 weeks delivery time.*

SKU	VARIANT	INCL. VAT	EXCL. VAT
1960539	STAPLE WALL LAMP, BLACK	199,95	167,32
1960839	STAPLE WALL LAMP, BRASS	229,95	192,42

TECHNICAL SPECIFICATIONS

PRODUCT TYPE
Wall lamp

WEIGHT
0,5 kg / 1,1 lb

CORD MATERIAL AND COLOUR
Textile, black, black plug.

ENVIRONMENT
Indoor

VOLTAGE
220 V / 110 V

CORD LENGTH
200 cm / 78,7"
The cord can be cut and hard wired.

DIMENSIONS
H: 18 cm / 7,1"
D: 18 cm / 7,1"

LIGHT SOURCE & ENERGY EFFICIENCY CLASS
CE (E27) / US (E26) (Not included)
MAX 60 W
A++, A+, A, B, C, D

CLASSIFICATION
IP20

PRODUCTION PROCESS
The arm is made from solid brass rods and sand-cast brass fittings. The base is made of drawn brass. The shade is made from spun, solid brass with a powder coated surface. The brass is lightly varnished to maintain its natural lustre.

LIGHT SPECIFICATION
Lumen, Kelvin and Ra value depends on which bulb is used.

CERTIFICATIONS
CE certified, tests can be obtained upon request.

COLOURS
Brass
Black (RAL 9005)

DIMMER
Yes, on cord

PACKAGING TYPE
Gift box

MATERIALS
Powder coated steel and solid brass (fine texture, matte).

CANOPY
Yes (as base), in solid brass or steel.
Ø: 9 cm / 3,5"
H: 1,2 cm / 0,5"

PACKAGING MEASUREMENTS (H x W x D)
10 cm x 27,5 cm x 25 cm / 3,9" x 10,8" x 9,8"

MATERIALS & MAINTENANCE
Please see page 486 for materials and care and maintenance instructions.

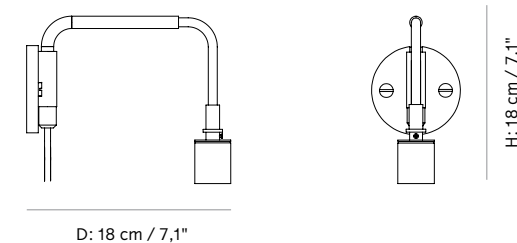

TR Bulb

BY TIM RUNDLE

Portable, opal glass LED bulb with a shiny or matte finish and dimmable as standard or with dim to warm function.

DIM TO WARM

The effect known as dim to warm lowers the colour temperature of an LED bulb when dimmed. The lower the brightness, the warmer (more orange) the colour to create a more natural ambience reminiscent of the sky at sunset. Dimming does not alter the colour temperature, but rather simply lowers the light level. TR Bulb is offered in both versions.



PRODUCT OPTIONS



Matte Opal
1470639



Shiny Opal
1470629



Matte Opal w / DiW
1480639



Shiny Opal w / DiW
1480629

TR Bulb, Matte Opal, by Tim Rundle

TR Bulb

BY TIM RUNDLE

STOCK OPTIONS — PRICES IN EUR *Selected combinations up to 2 weeks delivery time.*

SKU	VARIANT	INCL. VAT	EXCL. VAT
1470639	TR BULB, MATTE OPAL	99,95	83,64
1470629	TR BULB, SHINY OPAL	99,95	83,64
1480639	TR BULB, W / DIM TO WARM, MATTE OPAL	99,95	83,64
1480629	TR BULB, W / DIM TO WARM, SHINY OPAL	99,95	83,64

TECHNICAL SPECIFICATIONS

PRODUCT TYPE
Bulb

ENVIRONMENT
Indoor

DIMENSIONS
Ø: 20 cm / 7,9"

COLOURS
Matte opal
Shiny opal

PRODUCTION PROCESS
The globe shade is made from mouth-blown opal glass and the core is designed in aluminium to draw heat away from the LED light source.

MATERIALS
Opal glass, LED COB

LIGHT SOURCE & ENERGY EFFICIENCY CLASS

TR bulb (CE)
Standard: E27, 7,2 W, A+
Dim to warm: E27, 6 W, A+

TR bulb (US)
Standard: E26, 6 W, A+
Dim to warm: E26, 6 W, A+

Both bulbs are dimmable (trailing edge)

WEIGHT
0,694 kg / 1,5 lb
Weight can vary

VOLTAGE
220 - 240 V / 110 V

LIGHT SPECIFICATIONS

TR Bulb (CE) standard
Watt: 7,2 W
Lumen output: 70 lm / W
Colour temperature: 2700 K
CRI: > 80

TR Bulb (CE) dim to warm (DiW)
Watt: 6 W
Lumen output: 70 lm / W
Colour temperature: 1800 - 2700 K
CRI: > 80 - 90

TR Bulb (US) standard
Watt: 6 W
Lumen output: 70 lm / W
Colour temperature: 2700 K
CRI: > 80

TR Bulb (US) dim to warm (DiW)
Watt: 6 W
Lumen output: 70 lm / W
Colour temperature: 1800 - 2700 K
CRI: > 80 - 90

CORD MATERIAL AND COLOUR
N / A

CORD LENGTH
N / A

CLASSIFICATION
IP20

CERTIFICATIONS
CE and ETL certified, tests can be obtained upon request.

PACKAGING TYPE
Gift box

PACKAGING MEASUREMENTS (H x W x D)
26 cm x 25,5 cm x 25,5 cm / 10,2" x 10" x 10"

MATERIALS & MAINTENANCE
Please see page 486 for materials and care and maintenance instructions.

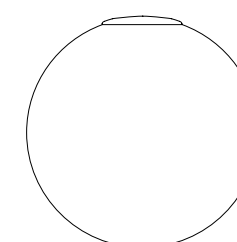

Ø: 20 cm / 7,9"

TR Bulb Suspension Frame

BY TIM RUNDLE

Suspension lamp in black powder coated steel or brushed brass. Opal glass bulb with a shiny or matte finish.

PRODUCT OPTIONS

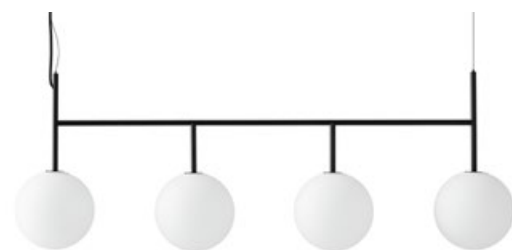

Black, Matte Opal Bulb
1495639

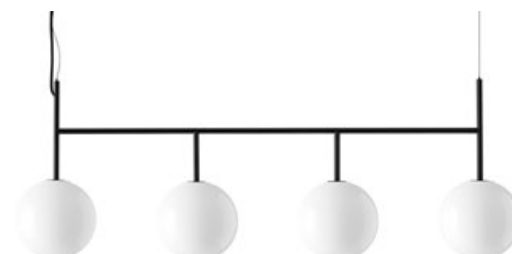

Black, Shiny Opal Bulb
1495629



Brushed Brass, Matte Opal Bulb
1465639



Brushed Brass, Shiny Opal Bulb
1465629

TR Bulb Suspension Frame, Brushed Brass / Matte Opal Bulb, by Tim Rundle

TR Bulb Suspension Frame

BY TIM RUNDLE

STOCK OPTIONS — PRICES IN EUR *Selected combinations up to 2 weeks delivery time.*

SKU	VARIANT	INCL. VAT	EXCL. VAT
1495639	TR BULB, SUSPENSION FRAME, BLACK W / MATTE OPAL BULB	699,95	585,72
1495629	TR BULB, SUSPENSION FRAME, BLACK W / SHINY OPAL BULB	699,95	585,72
1465639	TR BULB, SUSPENSION FRAME, BRUSHED BRASS W / MATTE OPAL BULB	999,95	836,76
1465629	TR BULB, SUSPENSION FRAME, BRUSHED BRASS W / SHINY OPAL BULB	999,95	836,76

TECHNICAL SPECIFICATIONS

PRODUCT TYPE
Suspension frame

ENVIRONMENT
Indoor

DIMENSIONS
H: 45 cm / 17,7"
W: 20 cm / 7,9"
L: 125 cm / 49,2"

COLOURS
Black (RAL 9005)
Brushed brass

PRODUCTION PROCESS
The globe shade is made from mouth-blown opal glass and the core is designed with aluminium to draw heat away from the LED light source, allowing the bulb to run at the optimum temperature. Accessory fittings are made of brushed brass or painted steel.

MATERIALS
Powder coated steel or brushed brass with lacquer, opal glass (matte or shiny), LED COB.

WEIGHT
4,4 kg / 9,7 lb

VOLTAGE
220 - 240 V / 110 V

LIGHT SOURCE & ENERGY EFFICIENCY CLASS
CE: Standard: E27, 7,2 W, A+
US: Standard: E26, 6 W, A+
Both bulbs are dimmable (trailing edge)

LIGHT SPECIFICATIONS

TR Bulb (CE)
Standard
Watt: 7,2 W
Lumen output: 70 lm / W
Colour temperature: 2700 K
CRI: > 80

TR Bulb (US)
Standard
Watt: 6 W
Lumen output: 70 lm / W
Colour temperature: 2700 K
CRI: > 80

DIMMER
No. The lamp can be connected to a dimmer system.

CANOPY
Yes, ABS, black
Ø: 11,5 cm / 4,5"
H: 3,8 cm / 1,5"

CORD MATERIAL AND COLOUR
Textile, black.

CORD LENGTH
300 cm / 118,1"

CLASSIFICATION
IP20

CERTIFICATIONS
CE and ETL certified, tests can be obtained upon request.

PACKAGING TYPE
Gift box

PACKAGING MEASUREMENTS (H x W x D)
26,5 cm x 136,5 cm x 43,8 cm / 10,4" x 53,7" x 17,2"

MATERIALS & MAINTENANCE
Please see page 486 for materials and care and maintenance instructions.

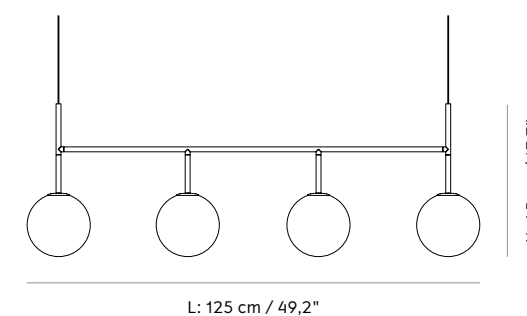

TR Bulb Suspension Frame w/Dim to Warm

BY TIM RUNDLE

Suspension lamp in black powder coated steel or brushed brass. Opal glass bulb with a shiny or matte finish and dim to warm function.

DIM TO WARM

The effect known as dim to warm lowers the colour temperature of an LED bulb when dimmed. The lower the brightness, the warmer (more orange) the colour to create a more natural ambience reminiscent of the sky at sunset. Dimming does not alter the colour temperature, but rather simply lowers the light level. TR Bulb is offered in both versions.

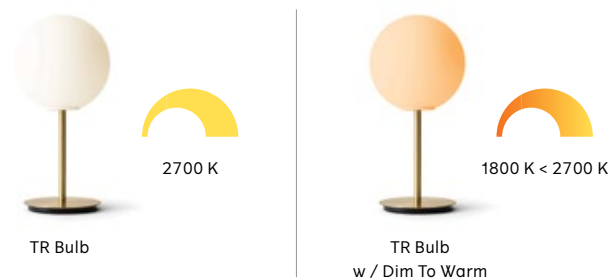

PRODUCT OPTIONS

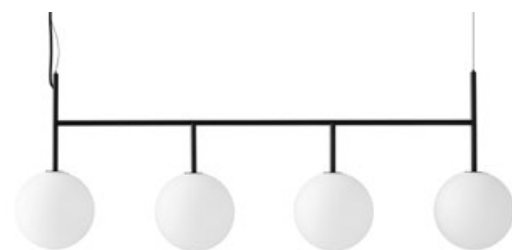

Black w / DtW, Matte Opal Bulb
1495689

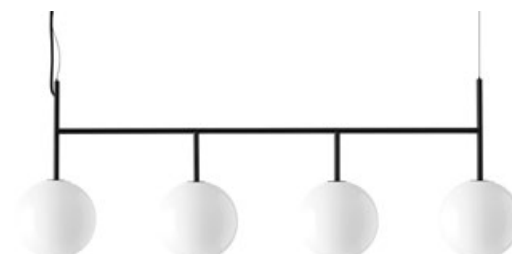

Black w / DtW, Shiny Opal Bulb
1495679



Brushed Brass w / DtW, Matte Opal Bulb
1465689



Brushed Brass w / DtW, Shiny Opal Bulb
1465679

TR Bulb Suspension Frame w / Dim to Warm, Brushed Brass / Matte Opal Bulb, by Tim Rundle

TR Bulb Suspension Frame w/Dim to Warm

BY TIM RUNDLE

STOCK OPTIONS — PRICES IN EUR *Selected combinations up to 2 weeks delivery time.*

SKU	VARIANT	INCL. VAT	EXCL. VAT
1495689	TR BULB, SUSPENSION FRAME, BLACK W / DTW, MATTE OPAL BULB	699,95	585,72
1495679	TR BULB, SUSPENSION FRAME, BLACK W / DTW, SHINY OPAL BULB	699,95	585,72
1465689	TR BULB, SUSPENSION FRAME, BRUSHED BRASS W / DTW, MATTE OPAL BULB	999,95	836,76
1465679	TR BULB, SUSPENSION FRAME, BRUSHED BRASS W / DTW, SHINY OPAL BULB	999,95	836,76

TECHNICAL SPECIFICATIONS

PRODUCT TYPE
Suspension frame

ENVIRONMENT
Indoor

DIMENSIONS
H: 45 cm / 17,7"
W: 20 cm / 7,9"
L: 125 cm / 49,2"

COLOURS
Black (RAL 9005)
Brushed brass

PRODUCTION PROCESS
The globe shade is made from mouth-blown opal glass and the core is designed with aluminium to draw heat away from the LED light source, allowing the bulb to run at the optimum temperature. Accessory fittings are made of brushed brass or painted steel.

MATERIALS
Powder coated steel or brushed brass with lacquer, opal glass (matte or shiny), LED COB.

WEIGHT
4,4 kg / 9,7 lb

VOLTAGE
220 - 240 V / 110 V

LIGHT SOURCE & ENERGY EFFICIENCY CLASS
CE: Dim to warm: E27, 6 W, A+
US: Dim to warm: E26, 6 W, A+
Both bulbs are dimmable (trailing edge)

LIGHT SPECIFICATIONS

TR Bulb (CE)
Dim to warm (DtW)
Watt: 6 W
Lumen output: 70 lm / W
Colour temperature: 1800 - 2700 K
CRI: > 80 - 90

TR Bulb (US)
Dim to warm (DtW)
Watt: 6 W
Lumen output: 70 lm / W
Colour temperature: 1800 - 2700 K
CRI: > 80 - 90

DIMMER
No. The lamp can be connected to a dimmer system.

CANOPY
Yes, ABS, black
Ø: 11,5 cm / 4,5"
H: 3,8 cm / 1,5"

CORD MATERIAL AND COLOUR
Textile, black.

CORD LENGTH
300 cm / 118,1"

CLASSIFICATION
IP20

CERTIFICATIONS
CE and ETL certified, tests can be obtained upon request.

PACKAGING TYPE
Gift box

PACKAGING MEASUREMENTS (H x W x D)
26,5 cm x 136,5 cm x 43,8 cm / 10,4" x 53,7" x 17,2"

MATERIALS & MAINTENANCE
Please see page 486 for materials and care and maintenance instructions.

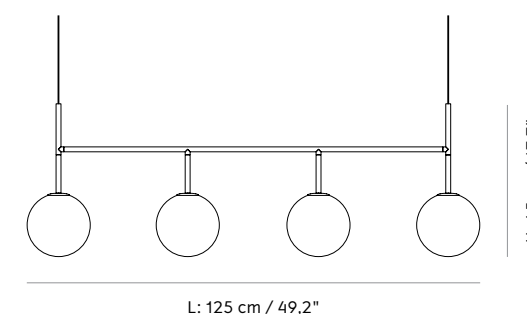

TR Bulb Pendant

BY TIM RUNDLE

Black powder coated steel or brushed brass pendant with textile cord.

PRODUCT OPTIONS



Black, Matte Opal Bulb
1493639



Black, Shiny Opal Bulb
1493629



Brushed Brass, Matte Opal Bulb
1493939



Brushed Brass, Shiny Opal Bulb
1493929

TR Bulb Pendant, Brushed Brass / Shiny Opal Bulb, by Tim Rundle

TR Bulb Pendant

BY TIM RUNDLE

STOCK OPTIONS — PRICES IN EUR *Selected combinations up to 2 weeks delivery time.*

SKU	VARIANT	INCL. VAT	EXCL. VAT
1493639	TR BULB, PENDANT, BLACK W / MATTE OPAL BULB	149,95	125,48
1493629	TR BULB, PENDANT, BLACK W / SHINY OPAL BULB	149,95	125,48
1493939	TR BULB, PENDANT, BRUSHED BRASS W / MATTE OPAL BULB	199,95	167,32
1493929	TR BULB, PENDANT, BRUSHED BRASS W / SHINY OPAL BULB	199,95	167,32

TECHNICAL SPECIFICATIONS

PRODUCT TYPE
Pendant

ENVIRONMENT
Indoor

DIMENSIONS
H: 30 cm / 11,8"
Ø: 20 cm / 7,9"

COLOURS
Black (RAL 9005)
Brushed brass

PRODUCTION PROCESS
The globe shade is made from mouth-blown opal glass and the core is designed with aluminium to draw heat away from the LED light source, allowing the bulb to run at the optimum temperature. Accessory fittings are made of brushed brass or painted steel.

MATERIALS
Powder coated steel or brushed brass with lacquer, opal glass (matte or shiny), LED COB.

WEIGHT
1,1 kg / 2,4 lb

VOLTAGE
220 - 240 V / 110 V

LIGHT SOURCE & ENERGY EFFICIENCY CLASS
CE: Standard: E27, 7,2 W, A+
US: Standard: E26, 6 W, A+
Both bulbs are dimmable (trailing edge)

LIGHT SPECIFICATIONS

TR Bulb (CE)
Standard
Watt: 7,2 W
Lumen output: 70 lm / W
Colour temperature: 2700 K
CRI: > 80

TR Bulb (US)
Standard
Watt: 6 W
Lumen output: 70 lm / W
Colour temperature: 2700 K
CRI: > 80

DIMMER
No. The lamp can be connected to a dimmer system.

CANOPY
Yes, ABS, black
Ø: 11,5 cm / 4,5"
H: 3,8 cm / 1,5"

CORD MATERIAL AND COLOUR
Textile, black.

CORD LENGTH
300 cm / 118,1"

CLASSIFICATION
IP20

CERTIFICATIONS
CE and ETL certified, tests can be obtained upon request.

PACKAGING TYPE
Gift box

PACKAGING MEASUREMENTS (H x W x D)
26 cm x 36 cm x 25,5 cm / 10,2" x 14,2" x 10"

MATERIALS & MAINTENANCE
Please see page 486 for materials and care and maintenance instructions.

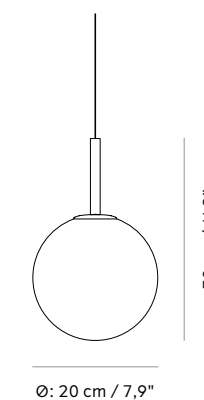

TR Bulb Pendant w/Dim to Warm

BY TIM RUNDLE

Black powder coated steel or brushed brass pendant with textile cord. Opal glass bulb with a shiny or matte finish and dim to warm function.

DIM TO WARM

The effect known as dim to warm lowers the colour temperature of an LED bulb when dimmed. The lower the brightness, the warmer (more orange) the colour to create a more natural ambience reminiscent of the sky at sunset. Dimming does not alter the colour temperature, but rather simply lowers the light level. TR Bulb is offered in both versions.

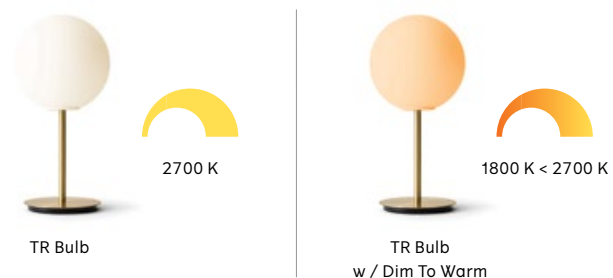

PRODUCT OPTIONS

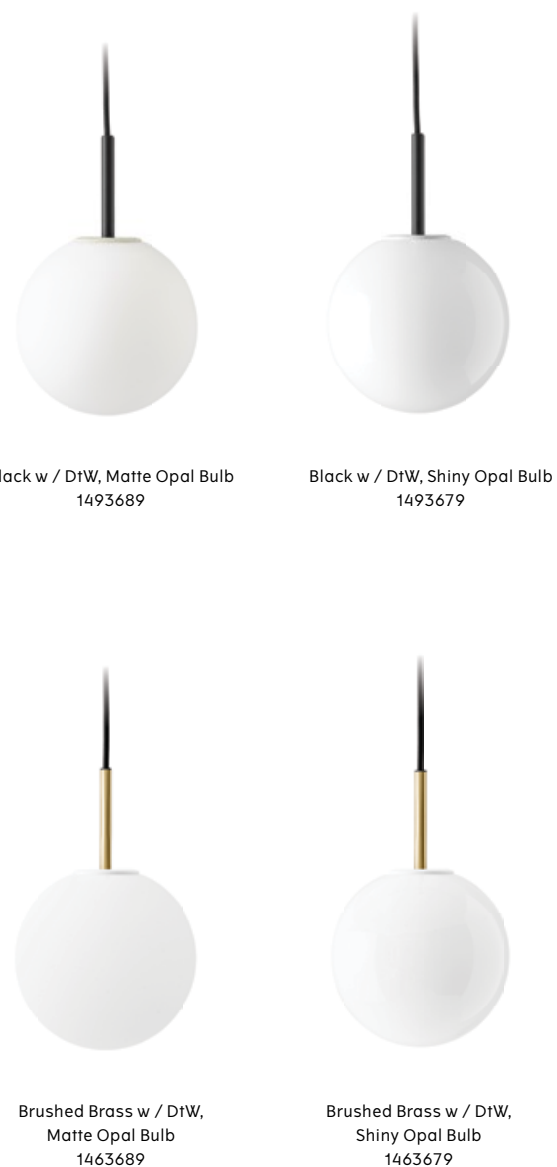

TR Bulb, Matte Opal, by Tim Rundle

TR Bulb Pendant w/Dim to Warm

BY TIM RUNDLE

STOCK OPTIONS — PRICES IN EUR *Selected combinations up to 2 weeks delivery time.*

SKU	VARIANT	INCL. VAT	EXCL. VAT
1493689	TR BULB, PENDANT, BLACK W / DTW, MATTE OPAL BULB	149,95	125,48
1493679	TR BULB, PENDANT, BLACK W / DTW, SHINY OPAL BULB	149,95	125,48
1463689	TR BULB, PENDANT, BRUSHED BRASS W / DTW, MATTE OPAL BULB	199,95	167,32
1463679	TR BULB, PENDANT, BRUSHED BRASS W / DTW, SHINY OPAL BULB	199,95	167,32

TECHNICAL SPECIFICATIONS

PRODUCT TYPE
Pendant

ENVIRONMENT
Indoor

DIMENSIONS
H: 30 cm / 11,8"
Ø: 20 cm / 7,9"

COLOURS
Black (RAL 9005)
Brushed brass

PRODUCTION PROCESS
The globe shade is made from mouth-blown opal glass and the core is designed with aluminium to draw heat away from the LED light source, allowing the bulb to run at the optimum temperature. Accessory fittings are made of brushed brass or painted steel.

MATERIALS
Powder coated steel or brushed brass with lacquer, opal glass (matte or shiny), LED COB.

WEIGHT
1,1 kg / 2,4 lb

VOLTAGE
220 - 240 V / 110 V

LIGHT SOURCE & ENERGY EFFICIENCY CLASS
CE: Dim to warm: E27, 6 W, A+
US: Dim to warm: E26, 6 W, A+
Both bulbs are dimmable (trailing edge)

LIGHT SPECIFICATIONS

TR Bulb (CE)
Dim to warm (DtW)
Watt: 6 W
Lumen output: 70 lm / W
Colour temperature: 1800 - 2700 K
CRI: > 80 - 90

TR Bulb (US)
Dim to warm (DtW)
Watt: 6 W
Lumen output: 70 lm / W
Colour temperature: 1800 - 2700 K
CRI: > 80 - 90

DIMMER
No. The lamp can be connected to a dimmer system.

CANOPY
Yes, ABS, black
Ø: 11,5 cm / 4,5"
H: 3,8 cm / 1,5"

CORD MATERIAL AND COLOUR
Textile, black.

CORD LENGTH
300 cm / 118,1"

CLASSIFICATION
IP20

CERTIFICATIONS
CE and ETL certified, tests can be obtained upon request.

PACKAGING TYPE
Gift box

PACKAGING MEASUREMENTS (H x W x D)
26 cm x 36 cm x 25,5 cm / 10,2" x 14,2" x 10"

MATERIALS & MAINTENANCE
Please see page 486 for materials and care and maintenance instructions.

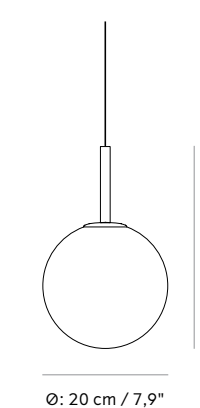

TR Bulb Table Lamp

BY TIM RUNDLE

Black powder coated steel lamp with circular grey marble base or brushed brass. Opal glass bulb with a shiny or matte finish. Textile cord with dimmer switch.

PRODUCT OPTIONS



Grey Marble, Matte Opal Bulb
1491639



Grey Marble, Shiny Opal Bulb
1491629



Brushed Brass, Matte Opal Bulb
1461639



Brushed Brass, Shiny Opal Bulb
1461629



TR Bulb Table Lamp, Brushed Brass / Shiny Opal Bulb, by Tim Rundle

TR Bulb Table Lamp

BY TIM RUNDLE

STOCK OPTIONS — PRICES IN EUR *Selected combinations up to 2 weeks delivery time.*

SKU	VARIANT	INCL. VAT	EXCL. VAT
1491639	TR BULB, TABLE LAMP, GREY MARBLE W / MATTE OPAL BULB	249,95	209,16
1491629	TR BULB, TABLE LAMP, GREY MARBLE W / SHINY OPAL BULB	249,95	209,16
1461639	TR BULB, TABLE LAMP, BRUSHED BRASS W / MATTE OPAL BULB	349,95	292,84
1461629	TR BULB, TABLE LAMP, BRUSHED BRASS W / SHINY OPAL BULB	349,95	292,84

TECHNICAL SPECIFICATIONS

PRODUCT TYPE
Table lamp

ENVIRONMENT
Indoor

DIMENSIONS
H: 41 cm / 16,1"
Ø: 18 or 20 cm / 7,1" or 7,9"

COLOURS
Grey marble
Brushed brass

PRODUCTION PROCESS
The globe shade is made from mouth-blown opal glass and the core is designed with aluminium to draw heat away from the LED light source, allowing the bulb to run at the optimum temperature. Accessory fittings are made from cut and polished marble, brushed brass or painted steel.

MATERIALS
Powder coated steel or brushed brass with lacquer, opal glass (matte or shiny), LED COB.

WEIGHT
1,7 kg / 3,7 lb

VOLTAGE
220 - 240 V / 110 V

LIGHT SOURCE & ENERGY EFFICIENCY CLASS
CE: Standard: E27, 7,2 W, A+
US: Standard: E26, 6 W, A+
Both bulbs are dimmable (trailing edge)

LIGHT SPECIFICATION

TR Bulb (CE)
Standard
Watt: 7,2 W
Lumen output: 70 lm / W
Colour temperature: 2700 K
CRI: > 80

TR Bulb (US)
Standard
Watt: 6 W
Lumen output: 70 lm / W
Colour temperature: 2700 K
CRI: > 80

DIMMER
Yes, on cord.

CANOPY
No

CORD MATERIAL AND COLOUR
Textile, black.

CORD LENGTH
200 cm / 78,7"

CLASSIFICATION
IP20

CERTIFICATIONS
CE and ETL certified, tests can be obtained upon request.

PACKAGING TYPE
Gift box

PACKAGING MEASUREMENTS (H x W x D)
26,5 cm x 36 cm x 32,5 cm / 10,4" x 14,2" x 12,8"

MATERIALS & MAINTENANCE
Please see page 486 for materials and care and maintenance instructions.

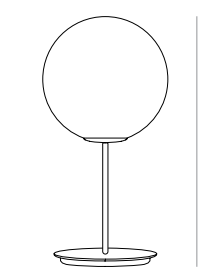

Ø: 20 cm / 7,9"

H: 41 cm / 16,1"

TR Bulb Table Lamp w/Dim to Warm

BY TIM RUNDLE

Black powder coated steel lamp with circular grey marble base or brushed brass. Opal glass bulb with a shiny or matte finish and dim to warm function. Textile cord with dimmer switch.

DIM TO WARM

The effect known as dim to warm lowers the colour temperature of an LED bulb when dimmed. The lower the brightness, the warmer (more orange) the colour to create a more natural ambience reminiscent of the sky at sunset. Dimming does not alter the colour temperature, but rather simply lowers the light level. TR Bulb is offered in both versions.

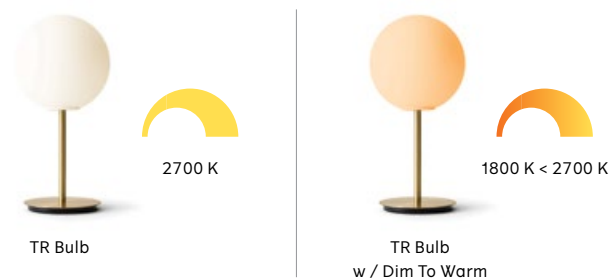

PRODUCT OPTIONS



Grey Marble w / DtW, Matte Opal Bulb
1491689



Grey Marble w / DtW, Shiny Opal Bulb
1491679



Brushed Brass w / DtW, Matte Opal Bulb
1461689



Brushed Brass w / DtW, Shiny Opal Bulb
1461679

TR Bulb Table Lamp w / Dim to Warm, Grey Marble / Shiny Opal Bulb, by Tim Rundle

TR Bulb Table Lamp w/Dim to Warm

BY TIM RUNDLE

STOCK OPTIONS — PRICES IN EUR *Selected combinations up to 2 weeks delivery time.*

SKU	VARIANT	INCL. VAT	EXCL. VAT
1491689	TR BULB, TABLE LAMP, GREY MARBLE W / DTW, MATTE OPAL BULB	249,95	209,16
1491679	TR BULB, TABLE LAMP, GREY MARBLE W / DTW, SHINY OPAL BULB	249,95	209,16
1461689	TR BULB, TABLE LAMP, BRUSHED BRASS W / DTW, MATTE OPAL BULB	349,95	292,84
1461679	TR BULB, TABLE LAMP, BRUSHED BRASS W / DTW, SHINY OPAL BULB	349,95	292,84

TECHNICAL SPECIFICATIONS

PRODUCT TYPE
Table lamp

ENVIRONMENT
Indoor

DIMENSIONS
H: 41 cm / 16,1"
Ø: 18 or 20 cm / 7,1" or 7,9"

COLOURS
Grey marble
Brushed brass

PRODUCTION PROCESS
The globe shade is made from mouth-blown opal glass and the core is designed with aluminium to draw heat away from the LED light source, allowing the bulb to run at the optimum temperature. Accessory fittings are made from cut and polished marble, brushed brass or painted steel.

MATERIALS
Powder coated steel or brushed brass with lacquer, opal glass (matte or shiny), LED COB.

WEIGHT
1,7 kg / 3,7 lb

VOLTAGE
220 - 240 V / 110 V

LIGHT SOURCE & ENERGY EFFICIENCY CLASS
CE: Dim to Warm: E27, 6 W, A+
US: Dim to Warm: E26, 6 W, A+
Both bulbs are dimmable (trailing edge)

LIGHT SPECIFICATION

TR Bulb (CE)
Dim to warm (DtW)
Watt: 6 W
Lumen output: 70 lm / W
Colour temperature: 1800 - 2700 K
CRI: > 80 - 90

TR Bulb (US)
Dim to warm (DtW)
Watt: 6 W
Lumen output: 70 lm / W
Colour temperature: 1800 - 2700 K
CRI: > 80 - 90

DIMMER
Yes, on cord.

CANOPY
No

CORD MATERIAL AND COLOUR
Textile, black.

CORD LENGTH
200 cm / 78,7"

CLASSIFICATION
IP20

CERTIFICATIONS
CE and ETL certified, tests can be obtained upon request.

PACKAGING TYPE
Gift box

PACKAGING MEASUREMENTS (H x W x D)
26,5 cm x 36 cm x 32,5 cm / 10,4" x 14,2" x 12,8"

MATERIALS & MAINTENANCE
Please see page 486 for materials and care and maintenance instructions.

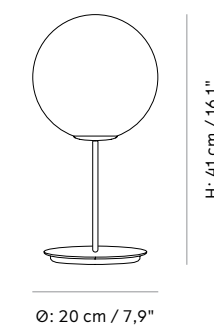

TR Bulb Table/Wall Lamp

BY TIM RUNDLE

Black powder coated steel lamp with circular grey marble base or brushed brass. Opal glass bulb with a shiny or matte finish. Textile cord with dimmer switch.

PRODUCT OPTIONS



Grey Marble, Matte Opal Bulb
1492639



Grey Marble, Shiny Opal Bulb
1492629



Brushed Brass, Matte Opal Bulb
1462639



Brushed Brass, Shiny Opal Bulb
1462629

TR Bulb Table / Wall Lamp, Brushed Brass / Matte Opal Bulb, by Tim Rundle
Plinth Low, Calacatta Viola Marble, by Norm Architects

TR Bulb Table/Wall Lamp

BY TIM RUNDLE

STOCK OPTIONS — PRICES IN EUR *Selected combinations up to 2 weeks delivery time.*

SKU	VARIANT	INCL. VAT	EXCL. VAT
1492639	TR BULB, TABLE / WALL LAMP, GREY MARBLE W / MATTE OPAL BULB	249,95	209,16
1492629	TR BULB, TABLE / WALL LAMP, GREY MARBLE W / SHINY OPAL BULB	249,95	209,16
1462639	TR BULB, TABLE / WALL LAMP, BRUSHED BRASS W / MATTE OPAL BULB	349,95	292,84
1462629	TR BULB, TABLE / WALL LAMP, BRUSHED BRASS W / SHINY OPAL BULB	349,95	292,84

TECHNICAL SPECIFICATIONS

PRODUCT TYPE
Table / Wall lamp

ENVIRONMENT
Indoor

DIMENSIONS
H: 22 cm / 8,7"
Ø: 16 or 20 cm / 6,2" or 7,9"

COLOURS
Grey marble
Brushed brass

PRODUCTION PROCESS
The globe shade is made from mouth-blown opal glass and the core is designed with aluminium to draw heat away from the LED light source, allowing the bulb to run at the optimum temperature. Accessory fittings are made from cut and polished marble, brushed brass or painted steel.

MATERIALS
Powder coated steel or brushed brass with lacquer, opal glass (matte or shiny), LED COB.

WEIGHT
1,6 kg / 3,5 lb

VOLTAGE
220 - 240 V / 110 V

LIGHT SOURCE & ENERGY EFFICIENCY CLASS
CE: Standard: E27, 7,2 W, A+
US: Standard: E26, 6 W, A+
Both bulbs are dimmable (trailing edge)

LIGHT SPECIFICATION

TR Bulb (CE)
Standard
Watt: 7,2 W
Lumen output: 70 lm / W
Colour temperature: 2700 K
CRI: > 80

TR Bulb (US)
Standard
Watt: 6 W
Lumen output: 70 lm / W
Colour temperature: 2700 K
CRI: > 80

DIMMER
Yes, on cord.

CANOPY
No

CORD MATERIAL AND COLOUR
Textile, black, black plug.

CORD LENGTH
200 cm / 78,7"

CLASSIFICATION
IP20

CERTIFICATIONS
CE and ETL certified, tests can be obtained upon request.

PACKAGING TYPE
Gift box

PACKAGING MEASUREMENTS (H x W x D)
26 cm x 50 cm x 25,6 cm / 10" x 19,7" x 10"

MATERIALS & MAINTENANCE
Please see page 486 for materials and care and maintenance instructions.

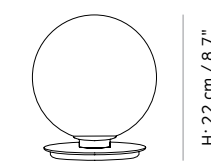

Ø: 20 cm / 7,9"

TR Bulb Table/Wall Lamp w/Dim to Warm

BY TIM RUNDLE

Black powder coated steel lamp with circular grey marble base or brushed brass. Opal glass bulb with a shiny or matte finish and dim to warm function. Textile cord with dimmer switch.

DIM TO WARM

The effect known as dim to warm lowers the colour temperature of an LED bulb when dimmed. The lower the brightness, the warmer (more orange) the colour to create a more natural ambience reminiscent of the sky at sunset. Dimming does not alter the colour temperature, but rather simply lowers the light level. TR Bulb is offered in both versions.

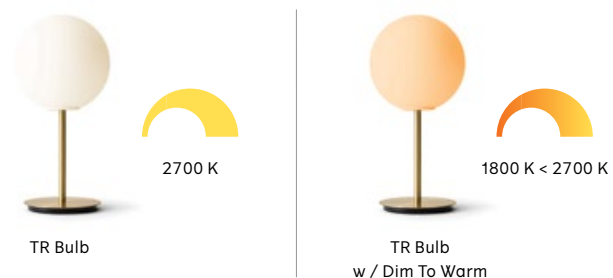

PRODUCT OPTIONS



Grey Marble w / DiW, Matte Opal Bulb
1492689



Grey Marble w / DiW, Shiny Opal Bulb
1492679



Brushed Brass w / DiW, Matte Opal Bulb
1462689



Brushed Brass w / DiW, Shiny Opal Bulb
1462679

TR Bulb Table / Wall Lamp w / Dim to Warm, Brushed Brass/Shiny Opal Bulb, by Tim Rundle

TR Bulb Table/Wall Lamp w/Dim to Warm

BY TIM RUNDLE

STOCK OPTIONS — PRICES IN EUR *Selected combinations up to 2 weeks delivery time.*

SKU	VARIANT	INCL. VAT	EXCL. VAT
1492689	TR BULB, TABLE / WALL LAMP, GREY MARBLE W / DTW, MATTE OPAL BULB	249,95	209,16
1492679	TR BULB, TABLE / WALL LAMP, GREY MARBLE W / DTW, SHINY OPAL BULB	249,95	209,16
1462689	TR BULB, TABLE / WALL LAMP, BRUSHED BRASS W / DTW, MATTE OPAL BULB	349,95	292,84
1462679	TR BULB, TABLE / WALL LAMP, BRUSHED BRASS W / DTW, SHINY OPAL BULB	349,95	292,84

TECHNICAL SPECIFICATIONS

PRODUCT TYPE
Table / Wall lamp

ENVIRONMENT
Indoor

DIMENSIONS
H: 22 cm / 8,7"
Ø: 16 or 20 cm / 6,2" or 7,9"

COLOURS
Grey marble
Brushed brass

PRODUCTION PROCESS
The globe shade is made from mouth-blown opal glass and the core is designed with aluminium to draw heat away from the LED light source, allowing the bulb to run at the optimum temperature. Accessory fittings are made from cut and polished marble, brushed brass or painted steel.

MATERIALS
Powder coated steel or brushed brass with lacquer, opal glass (matte or shiny), LED COB.

WEIGHT
1,6 kg / 3,5 lb

VOLTAGE
220 - 240 V / 110 V

LIGHT SOURCE & ENERGY EFFICIENCY CLASS
CE: Dim to warm: E27, 6 W, A+
US: Dim to warm: E26, 6 W A+
Both bulbs are dimmable (trailing edge)

LIGHT SPECIFICATION

TR Bulb (CE)
Dim to warm (DiW)
Watt: 6 W
Lumen output: 70 lm / W
Colour temperature: 1800 - 2700 K
CRI: > 80 - 90

TR Bulb (US)
Dim to warm (DiW)
Watt: 6 W
Lumen output: 70 lm / W
Colour temperature: 1800 - 2700 K
CRI: > 80 - 90

DIMMER
Yes, on cord.

CANOPY
No

CORD MATERIAL AND COLOUR
Textile, black, black plug.

CORD LENGTH
200 cm / 78,7"

CLASSIFICATION
IP20

CERTIFICATIONS
CE and ETL certified, tests can be obtained upon request.

PACKAGING TYPE
Gift box

PACKAGING MEASUREMENTS (H x W x D)
26 cm x 50 cm x 25,6 cm / 10" x 19,7" x 10"

MATERIALS & MAINTENANCE
Please see page 486 for materials and care and maintenance instructions.



TR Bulb Ceiling/Wall Lamp

BY TIM RUNDLE

Black powder coated steel or brushed brass ceiling / wall lamp with PVC cord. Opal glass bulb with a shiny or matte finish.

PRODUCT OPTIONS



Black, Matte Opal Bulb
1494639



Black, Shiny Opal Bulb
1494629



Brushed Brass, Matte Opal Bulb
1464639



Brushed Brass, Shiny Opal Bulb
1464629

TR Bulb Ceiling / Wall Lamp, Black / Matte Opal Bulb, by Tim Rundle
Harbour Dining Chair, Black Steel / Nuance 40782, by Norm Architects
Androgyne Side Table, Black Steel / Nero Marquina Marble, by Danielle Siggerud

TR Bulb Ceiling/Wall Lamp

BY TIM RUNDLE

STOCK OPTIONS — PRICES IN EUR *Selected combinations up to 2 weeks delivery time.*

SKU	VARIANT	INCL. VAT	EXCL. VAT
1494639	TR BULB, CEILING / WALL LAMP, BLACK W / MATTE OPAL BULB	199,95	167,32
1494629	TR BULB, CEILING / WALL LAMP, BLACK W / SHINY OPAL BULB	199,95	167,32
1464639	TR BULB, CEILING / WALL LAMP, BRUSHED BRASS W / MATTE OPAL BULB	269,95	225,89
1464629	TR BULB, CEILING / WALL LAMP, BRUSHED BRASS W / SHINY OPAL BULB	269,95	225,89

TECHNICAL SPECIFICATIONS

PRODUCT TYPE
Ceiling / Wall lamp

ENVIRONMENT
Indoor

DIMENSIONS
H: 22 cm / 8,7"
Ø: 16 or 20 cm / 6,2" or 7,9"

COLOURS
Black (RAL 9005)
Brushed brass

PRODUCTION PROCESS
The globe shade is made from mouth-blown opal glass and the core is designed with aluminium to draw heat away from the LED light source, allowing the bulb to run at the optimum temperature. Accessory fittings are made of brushed brass or painted steel.

MATERIALS
Powder coated steel or brushed brass with lacquer, opal glass (matte or shiny), LED COB.

WEIGHT
1,6 kg / 3,5 lb

VOLTAGE
220 - 240 V / 110 V

LIGHT SOURCE & ENERGY EFFICIENCY CLASS
CE: Standard: E27, 7,2 W, A+
US: Standard: E26, 6 W, A+
Both bulbs are dimmable (trailing edge)

LIGHT SPECIFICATION

TR Bulb (CE)
Standard
Watt: 7,2 W
Lumen output: 70 lm / W
Colour temperature: 2700 K
CRI: > 80

TR Bulb (US)
Standard
Watt: 6 W
Lumen output: 70 lm / W
Colour temperature: 2700 K
CRI: > 80

DIMMER
No. The lamp can be connected to a dimmer system.

CANOPY
No

CORD MATERIAL AND COLOUR
PVC, black.

CORD LENGTH
10 cm / 3,9"

CLASSIFICATION
IP20

CERTIFICATIONS
CE and ETL certified, tests can be obtained upon request.

PACKAGING TYPE
Gift box

PACKAGING MEASUREMENTS (H x W x D)
43 cm x 48,5 cm x 48,5 cm / 17" x 19" x 19"

MATERIALS & MAINTENANCE
Please see page 486 for materials and care and maintenance instructions.

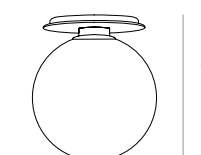

Ø: 20 cm / 7,9"

TR Bulb Ceiling/Wall Lamp w/Dim to Warm

BY TIM RUNDLE

Black powder coated steel or brushed brass ceiling / wall lamp with PVC cord. The opal glass bulb is available with a shiny or matte finish and dim to warm function.

DIM TO WARM

The effect known as dim to warm lowers the colour temperature of an LED bulb when dimmed. The lower the brightness, the warmer (more orange) the colour to create a more natural ambience reminiscent of the sky at sunset. Dimming does not alter the colour temperature, but rather simply lowers the light level. TR Bulb is offered in both versions.

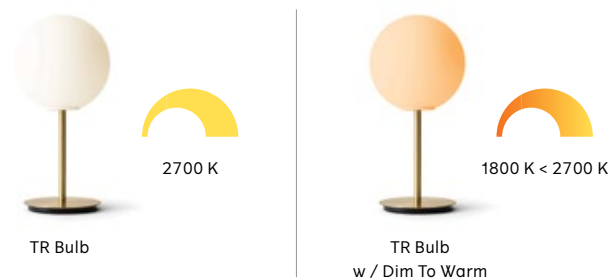

PRODUCT OPTIONS



Black w / DiW, Matte Opal Bulb
1494689



Black w / DiW, Shiny Opal Bulb
1494679



Brushed Brass w / DiW, Matte Opal Bulb
1464689



Brushed Brass w / DiW, Shiny Opal Bulb
1464679

TR Bulb Ceiling / Wall Lamp w / Dim to Warm, Brushed Brass / Shiny Opal Bulb, by Tim Rundle

TR Bulb Ceiling/Wall Lamp w/Dim to Warm

BY TIM RUNDLE

STOCK OPTIONS — PRICES IN EUR *Selected combinations up to 2 weeks delivery time.*

SKU	VARIANT	INCL. VAT	EXCL. VAT
1494689	TR BULB, CEILING / WALL LAMP, BLACK W / DTW, MATTE OPAL BULB	199,95	167,32
1494679	TR BULB, CEILING / WALL LAMP, BLACK W / DTW, SHINY OPAL BULB	199,95	167,32
1464689	TR BULB, CEILING / WALL LAMP, BRUSHED BRASS W / DTW, MATTE OPAL BULB	269,95	225,89
1464679	TR BULB, CEILING / WALL LAMP, BRUSHED BRASS W / DTW, SHINY OPAL BULB	269,95	225,89

TECHNICAL SPECIFICATIONS

PRODUCT TYPE
Ceiling / Wall lamp

ENVIRONMENT
Indoor

DIMENSIONS
H: 22 cm / 8,7"
Ø: 16 or 20 cm / 6,2" or 7,9"

COLOURS
Black (RAL 9005)
Brushed brass

PRODUCTION PROCESS
The globe shade is made from mouth-blown opal glass and the core is designed with aluminium to draw heat away from the LED light source, allowing the bulb to run at the optimum temperature. Accessory fittings are made of brushed brass or painted steel.

MATERIALS
Powder coated steel or brushed brass with lacquer, opal glass (matte or shiny), LED COB.

WEIGHT
1,6 kg / 3,5 lb

VOLTAGE
220 - 240 V / 110 V

LIGHT SOURCE & ENERGY EFFICIENCY CLASS
CE: Dim to Warm: E27, 6 W, A+
US: Dim to Warm: E26, 6 W, A+
Both bulbs are dimmable (trailing edge)

LIGHT SPECIFICATION

TR Bulb (CE)
Dim to warm (DiW)
Watt: 6 W
Lumen output: 70 lm / W
Colour temperature: 1800 - 2700 K
CRI: > 80 - 90

TR Bulb (US)
Dim to warm (DiW)
Watt: 6 W
Lumen output: 70 lm / W
Colour temperature: 1800 - 2700 K
CRI: > 80 - 90

DIMMER
No. The lamp can be connected to a dimmer system.

CANOPY
No

CORD MATERIAL AND COLOUR
PVC, black.

CORD LENGTH
10 cm / 3,9"

CLASSIFICATION
IP20

CERTIFICATIONS
CE and ETL certified, tests can be obtained upon request.

PACKAGING TYPE
Gift box

PACKAGING MEASUREMENTS (H x W x D)
43 cm x 48,5 cm x 48,5 cm / 17" x 19" x 19"

MATERIALS & MAINTENANCE
Please see page 486 for materials and care and maintenance instructions.



JWDA Table Lamp

BY JONAS WAGELL

Polished brass, bronzed brass, black powder coated steel or concrete base lamp with opal glass shade and dimmer switch.

PRODUCT OPTIONS



Bronzed Brass
1800859



Polished Brass
1800839



Black Steel
1810539



Concrete
1800129

JWDA Table Lamp, Polished Brass, by Jonas Wagell
JWDA Table Lamp, Bronzed Brass, by Jonas Wagell



JWDA Table Lamp

BY JONAS WAGELL

STOCK OPTIONS — PRICES IN EUR *Selected combinations up to 2 weeks delivery time.*

SKU	VARIANT	INCL. VAT	EXCL. VAT
1800859	JWDA TABLE LAMP, METALLIC, BRONZED BRASS	199,95	167,32
1800839	JWDA TABLE LAMP, METALLIC, MIRROR POLISHED BRASS	199,95	167,32
1810539	JWDA TABLE LAMP, METALLIC, BLACK STEEL	199,95	167,32
1800129	JWDA TABLE LAMP, CONCRETE, LIGHT GREY / BRASS	199,95	167,32

TECHNICAL SPECIFICATIONS

PRODUCT TYPE
Table lamp

ENVIRONMENT
Indoor

DIMENSIONS
H: 29 cm / 11,4"
Ø: 17 cm / 6,7"

COLOURS
Bronzed brass, shiny opal
Mirror polished brass, shiny opal
Black (RAL 9005), matte opal
Light grey concrete / brass, shiny opal

PRODUCTION PROCESS
Base in polished brass, brushed metal or concrete. The brass version is mirror polished but untreated so the metal will patinate over time. The glass shade is made from mouth-blown opal glass. The dimmer switch is made from bronzed or polished brass or oxidised steel.

MATERIALS
Stainless steel, solid brass or concrete, glass.

WEIGHT
1,35 kg / 3,0 lb

VOLTAGE
220 V / 110 - 130 V

LIGHT SOURCE & ENERGY EFFICIENCY CLASS
G9 (Included)
MAX 40 W
A++, A+, A, B, C, D

LIGHT SPECIFICATION

CE
G9, 2,8 W, dimmable
210 lm
2700 K
Ra > 80

US
G9, 4,5 W, dimmable
450 lm
2700 K
Ra > 80

DIMMER
Yes, on base.

CANOPY
N / A

CORD MATERIAL AND COLOUR
Bronzed brass: black textile, black plug
Mirror polished brass: black textile, black plug
Black: black textile, black plug
Light grey / brass: white textile, white plug

CORD LENGTH
200 cm / 78,7"

CLASSIFICATION
IP20

CERTIFICATIONS
CE and ETL certified, tests can be obtained upon request.

PACKAGING TYPE
Gift box

PACKAGING MEASUREMENTS (H x W x D)
33 cm x 19 cm x 19,5 cm / 12,9" x 7,5" x 7,7"

MATERIALS & MAINTENANCE
Please see page 486 for materials and care and maintenance instructions.

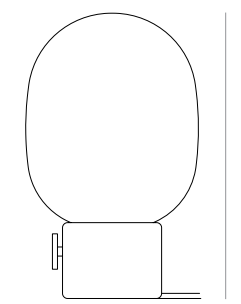

JWDA Table Lamp Marble

BY JONAS WAGELL

Marble base lamp with opal glass shade and dimmer switch.

PRODUCT OPTIONS



Carrara Marble
1830639

JWDA Table Lamp, Carrara Marble, by Jonas Wagell



JWDA Table Lamp Marble

BY JONAS WAGELL

STOCK OPTIONS — PRICES IN EUR *Selected combinations up to 2 weeks delivery time.*

SKU	VARIANT	INCL. VAT	EXCL. VAT
1830639	JWDA TABLE LAMP, CARRARA MARBLE	299,95	251,00

TECHNICAL SPECIFICATIONS

PRODUCT TYPE Table lamp	VOLTAGE 220 V / 110 - 130 V	CANOPY N / A
ENVIRONMENT Indoor	LIGHT SOURCE & ENERGY EFFICIENCY CLASS G9 (Included) MAX 40 W A++, A+, A, B, C, D	CORD MATERIAL AND COLOUR White textile, white plug.
DIMENSIONS H: 32 cm / 12,6" Ø: 19 cm / 7,5"	LIGHT SPECIFICATION	CORD LENGTH 200 cm / 78,7"
COLOURS White marble, matte opal.	CE G9, 2,8 W, dimmable 210 lm 2700 K Ra > 80	CLASSIFICATION IP20
PRODUCTION PROCESS Base in honed marble. The shade is made from mouth-blown opal glass. The dimmer switch is made from bronzed brass.	US G9, 4,5 W, dimmable 450 lm 2700 K Ra > 80	CERTIFICATIONS CE and ETL certified, tests can be obtained upon request.
MATERIALS Polished Carrera marble, glass, brass.	DIMMER Yes, on base.	PACKAGING TYPE Gift box
WEIGHT 2,1 kg / 5,0 lb		PACKAGING MEASUREMENTS (H x W x D) 37 cm x 20,5 cm x 20,5 cm / 14,5" x 8" x 8"
		MATERIALS & MAINTENANCE Please see page 486 for materials and care and maintenance instructions.

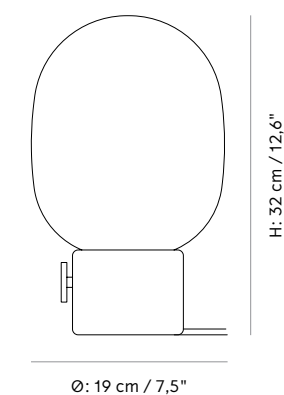

JWDA Pendant

BY JONAS WAGELL

Polished brass pendant with dimmer switch and shiny opal glass shade.

PRODUCT OPTIONS



Polished Brass
1820839

JWDA Pendant, Polished Brass, by Jonas Wagell



JWDA Pendant

BY JONAS WAGELL

STOCK OPTIONS — PRICES IN EUR *Selected combinations up to 2 weeks delivery time.*

SKU	VARIANT	INCL. VAT	EXCL. VAT
1820839	JWDA PENDANT LAMP, POLISHED BRASS	299,95	251,00

TECHNICAL SPECIFICATIONS

PRODUCT TYPE
Pendant

ENVIRONMENT
Indoor

DIMENSIONS
H: 33,5 cm / 13,2"
Ø: 23 cm / 9"

COLOURS
Polished brass, shiny opal.

PRODUCTION PROCESS
Base in polished brass. The brass version is mirror-polished but not lacquered, so the metal will patinate over time. The shade is made from mouth-blown opal glass. The dimmer switch is made of bronzed brass.

MATERIALS
Solid brass, glass.

WEIGHT
1,7 kg / 3,7 lb

VOLTAGE
220 V / 110 - 130 V

LIGHT SOURCE & ENERGY EFFICIENCY CLASS
G9 (Included)
MAX 40 W
A++, A+, A, B, C, D

LIGHT SPECIFICATION

CE
G9, 2,8 W, dimmable
210 lm
2700 K
Ra > 80

US
G9, 4,5 W, dimmable
450 lm
2700 K
Ra > 80

DIMMER
Yes

CANOPY
Black, ABS
Ø: 11,5 cm / 4,5"
H: 3,8 cm / 1,5"

CORD MATERIAL AND COLOUR
PVC wire, black.

CORD LENGTH
400 cm / 157,5"

CLASSIFICATION
CE and IP20

CERTIFICATIONS
CE and ETL certified, tests can be obtained upon request..

PACKAGING TYPE
Gift box

PACKAGING MEASUREMENTS (H x W x D)
53,5 cm x 30 cm x 30 cm / 20,9" x 11,8" x 11,8"

MATERIALS & MAINTENANCE
Please see page 486 for materials and care and maintenance instructions.

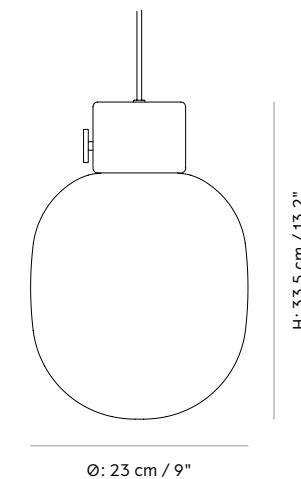

JWDA Floor Lamp

BY JONAS WAGELL

Solid brushed brass or solid bronzed brass stem lamp set on a rounded stone base with elliptical opal glass shade and brass dimmer switch.

JWDA Floor Lamp, Carrara Marble / Bronzed Brass, by Jonas Wagell



PRODUCT OPTIONS



Travertine / Brushed Brass
1840619



Carrara Marble / Bronzed Brass
1840639

JWDA Floor Lamp

BY JONAS WAGELL

STOCK OPTIONS — PRICES IN EUR *Selected combinations up to 2 weeks delivery time.*

SKU	VARIANT	INCL. VAT	EXCL. VAT
1840619	JWDA FLOOR LAMP, TRAVERTINE / BRUSHED BRASS	1,499,95	1,255,16
1840639	JWDA FLOOR LAMP, CARRARA MARBLE / BRONZED BRASS	1,499,95	1,255,16

TECHNICAL SPECIFICATIONS

PRODUCT TYPE
Floor lamp

ENVIRONMENT
Indoor

DIMENSIONS
H: 150 cm / 59"
Ø: 39 or 28 cm / 15,3" or 11"

COLOURS
Beige, brushed brass
White, bronzed brass

PRODUCTION PROCESS
Mouth-blown glass shade and machine-cut base with hand-polished finish. Details in cut solid brass.

MATERIALS
Travertine, brushed brass, steel and opal glass.
Carrara marble, bronzed brass, steel and opal glass.

WEIGHT
Lamp shade: 2,3 kg / 5,1 lb
Base, travertine: 11,3 kg / 24,9 lb
Base, Carrara marble: 12,6 kg / 27,8 lb

VOLTAGE
230 V / 110 V

LIGHT SOURCE & ENERGY EFFICIENCY CLASS
E27 (CE), 8 W
E26 (US), 8 W

LIGHT SPECIFICATION
8 W
700 lm
2200 K
Ra > 80

DIMMER
Yes, on the base.

CANOPY
N / A

CORD MATERIAL AND COLOUR
Black textile, black plug.

CORD LENGTH
250 cm / 98,4"

CERTIFICATIONS
CE and ETL certified, tests can be obtained upon request.

PACKAGING TYPE
Brown box

PACKAGING MEASUREMENTS (H x W x D)

Lampshade
36 cm x 46,5 cm x 46,5 cm / 14,2" x 18,3" x 8,3"

Base
133 cm x 28,5 cm x 28,5 cm / 52,4" x 11,2" x 11,2"

MATERIALS & MAINTENANCE
Please see page 486 for materials and care and maintenance instructions.

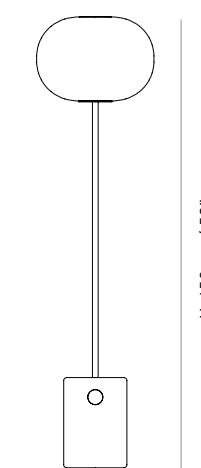

Ø: 21 cm / 8,3"

H: 150 cm / 59"

Carrie LED Lamp

BY NORM ARCHITECTS

Portable, lightweight and cordless lamp with a USB charger, opal glass shade and powder coated steel or brushed brass frame.

Carrie LED Lamp, Brushed Brass, by Norm Architects

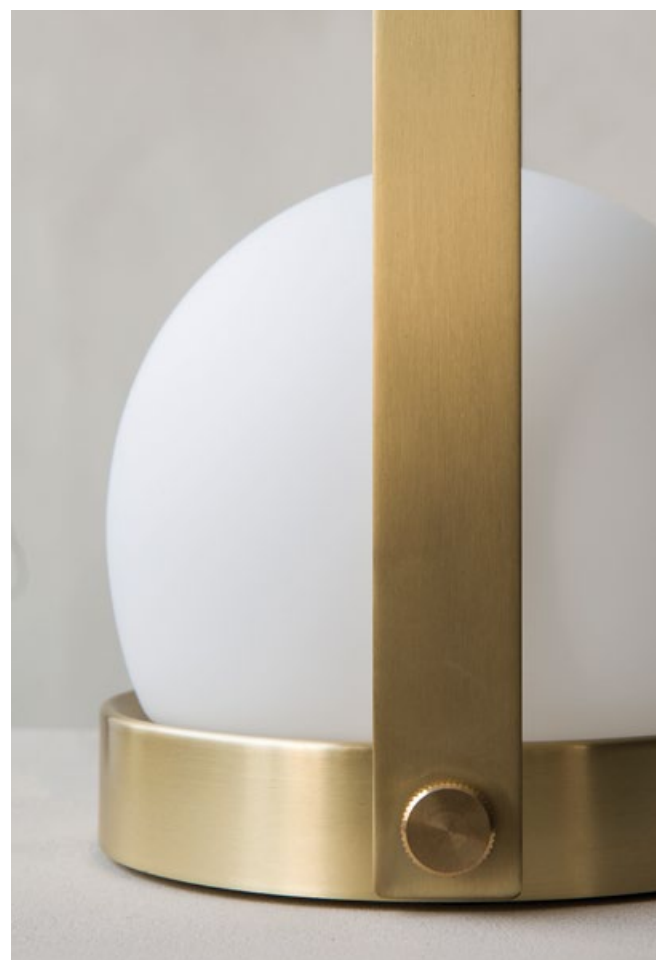

PRODUCT OPTIONS



Black
4863539



Burned Red
4863349



Olive
4863429



White
4863639



Brushed Brass
4863839

Carrie LED Lamp

BY NORM ARCHITECTS

STOCK OPTIONS — PRICES IN EUR *Selected combinations up to 2 weeks delivery time.*

SKU	VARIANT	INCL. VAT	EXCL. VAT
4863539	CARRIE LED LAMP, BLACK	169,95	142,21
4863349	CARRIE LED LAMP, BURNED RED	169,95	142,21
4863429	CARRIE LED LAMP, OLIVE	169,95	142,21
4863639	CARRIE LED LAMP, WHITE	169,95	142,21
4863839	CARRIE LED LAMP, BRUSHED BRASS	199,95	167,32

TECHNICAL SPECIFICATIONS

PRODUCT TYPE
LED lamp

ENVIRONMENT
Indoor / Outdoor (dry conditions only)

DIMENSIONS
H: 24,5 cm / 9,6"
Ø: 13,5 cm / 5,3"

COLOURS
Black (RAL 9005)
Burned red (RAL 8015)
Olive (NCS S8005-G80Y)
White (RAL 9016)
Brushed brass

PRODUCTION PROCESS
Mouth-blown opal glass shade with an acid finish. The base and handle is made from powder coated or plated steel or brushed brass.

MATERIALS
Steel or brass, glass.

WEIGHT
1 kg / 2,2 lb

VOLTAGE
220 V / 100 - 130 V

LIGHT SOURCE & ENERGY EFFICIENCY CLASS
LED panel (Included, not exchangeable)
3,2 W, LED, A+
5000 mAh battery

LIGHT SPECIFICATION
Lithium battery: 5000 mAh, 3.7 V
Lumen output: 120 lm / W
Colour temperature: 2700 K
CRI: > 80

DIMMER
Adjustable to three light settings.

CANOPY
N / A

CORD MATERIAL AND COLOUR
PVC, black (charging cord), black plug.

CORD LENGTH
70 cm / 27,6"

CLASSIFICATION
IP20

CERTIFICATIONS
CE certified, tests can be obtained upon request.

PACKAGING TYPE
Gift box

PACKAGING MEASUREMENTS (H x W x D)
29 cm x 16 cm x 16 cm / 11,4" x 6,3" x 6,3"

MATERIALS & MAINTENANCE
Please see page 486 for materials and care and maintenance instructions.

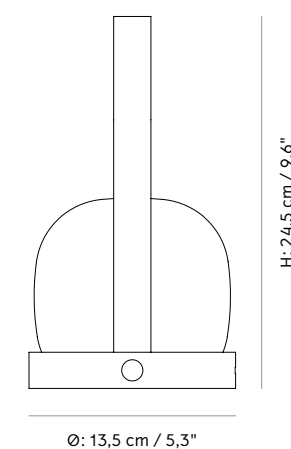

Circular Lamp

BY STUDIO WM

Anodised or powder coated aluminium lamp with brushed bronze or black finish, textile cord and mobile app technology that controls both light temperature and level, as well as group control for multiple lamps.

PRODUCT OPTIONS



Black
1680539



Brushed Bronze
1680869

Circular Lamp, Brushed Bronze, by Studio WM



Circular Lamp

BY STUDIO WM

STOCK OPTIONS — PRICES IN EUR *Selected combinations up to 2 weeks delivery time.*

SKU	VARIANT	INCL. VAT	EXCL. VAT
1680539	CIRCULAR LAMP, BLACK	669,95	560,61
1680869	CIRCULAR LAMP, BRUSHED BRONZE	669,95	560,61

TECHNICAL SPECIFICATIONS

PRODUCT TYPE Pendant	WEIGHT 3,5 kg / 7,7 lb	CORD MATERIAL AND COLOUR Textile, black.
ENVIRONMENT Indoor	VOLTAGE 230 V / 100 - 130 V	CORD LENGTH 500 cm / 197"
DIMENSIONS H: 23 cm / 9,1" Ø: 55 cm / 21,7"	LIGHT SOURCE & ENERGY EFFICIENCY CLASS LED (Included) 12 W, A	CLASSIFICATION IP20
COLOURS Black (RAL 9005) Brushed bronze	LIGHT SPECIFICATION 800 lm 2700 - 4000 K (standard 2700 K) Ra > 90	CERTIFICATIONS CE certified, tests can be obtained upon request.
PRODUCTION PROCESS Spun aluminium.	DIMMER Yes, with MENU Lighting App (iOS and Android).	PACKAGING TYPE Gift box
MATERIALS Powder coated or anodized aluminium, LED, PCB, PC.	CANOPY Yes, ABS, black Ø: 11,5 cm / 4,5" H: 3,8 cm / 1,5"	PACKAGING MEASUREMENTS (H x W x D) 20 cm x 62,7 cm x 62,7 cm / 7,9" x 24,7" x 24,7"
		MATERIALS & MAINTENANCE Please see page 486 for materials and care and maintenance instructions.

LUMINOUS INTENSITY DISTRIBUTION (UNIT: CD)

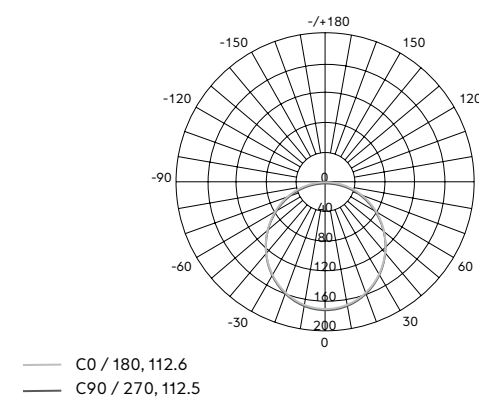

TECHNICAL DRAWING

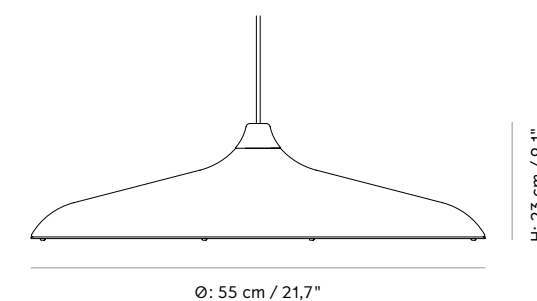

Task Pendant

BY GRY HOLMSKOV

Brushed anodised aluminium suspension lamp. Mobile app controls both light temperature and level, as well as group control for multiple lamps.

PRODUCT OPTIONS



Bronze Grey
1650169

Task Pendant, by Gry Holmskov



Task Pendant

BY GRY HOLMSKOV

STOCK OPTIONS — PRICES IN EUR *Selected combinations up to 2 weeks delivery time.*

SKU	VARIANT	INCL. VAT	EXCL. VAT
1650169	LED TASK PENDANT, BRONZE GREY	499,95	418,36

TECHNICAL SPECIFICATIONS

PRODUCT TYPE Pendant	WEIGHT 1 kg / 2.2 lb	CORD MATERIAL AND COLOUR PVC, black
ENVIRONMENT Indoor	VOLTAGE 230 V / 100 - 130 V	CORD LENGTH 500 cm / 197"
DIMENSIONS Ø: 2,5 cm / 1" W: 135 cm / 53,1"	LIGHT SOURCE & ENERGY EFFICIENCY CLASS LED (Included) 24 W, A	CLASSIFICATION IP20
COLOURS Bronze grey	LIGHT SPECIFICATION 1300 lm 2700 - 4000 K (standard 2700 K) Ra > 90	CERTIFICATIONS CE certified, tests can be obtained upon request.
PRODUCTION PROCESS Extruded aluminium.	DIMMER Yes, with MENU Lighting App (iOS and Android).	PACKAGING TYPE Gift box
MATERIALS Anodized aluminium, LED, PCB, PC	CANOPY Yes, aluminium, bronze Ø: 12 cm / 4,7" H: 4 cm / 1,6"	PACKAGING MEASUREMENTS (H x W x D) 15 cm x 139,5 cm x 11 cm / 5,9" x 54,9" x 4,3
		MATERIALS & MAINTENANCE Please see page 486 for materials and care and maintenance instructions.

LUMINOUS INTENSITY DISTRIBUTION (UNIT: CD)

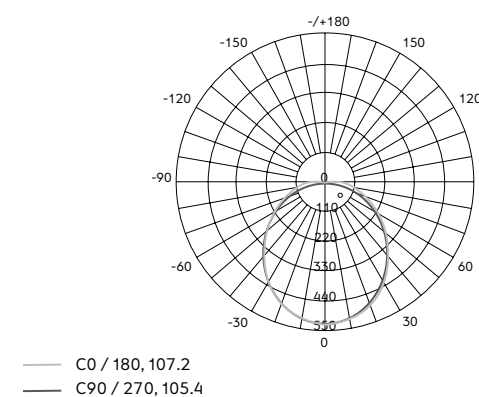

TECHNICAL DRAWING

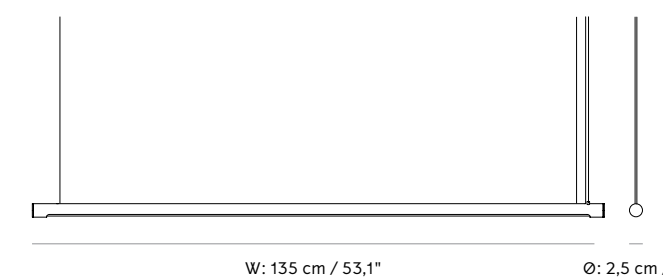

Column Table Lamp

BY NORM ARCHITECTS

Cordless anodised aluminium lamp with bronzed finish, rechargeable USB port and LED bulb adjustable to three settings.

PRODUCT OPTIONS



Bronze
1880869

Column Table Lamp, by Norm Architects



Column Table Lamp

BY NORM ARCHITECTS

STOCK OPTIONS — PRICES IN EUR *Selected combinations up to 2 weeks delivery time.*

SKU	VARIANT	INCL. VAT	EXCL. VAT
1880869	COLUMN, TABLE LAMP, BRONZE	169,95	142,21

TECHNICAL SPECIFICATIONS

PRODUCT TYPE Table lamp	WEIGHT 0,6 kg / 1,3 lb	CORD MATERIAL AND COLOUR Black PVC micro spin cord, black plug.
ENVIRONMENT Indoor	VOLTAGE 220 V (Plug: 5 V) / 110 - 130 V (Plug: 5 V)	CORD LENGTH 70 cm / 27,6"
DIMENSIONS H: 17,5 cm / 6,9" Ø: 12 cm / 4,7"	LIGHT SOURCE & ENERGY EFFICIENCY CLASS LED 3,2 W, A	CLASSIFICATION IP20
COLOURS Bronze	LIGHT SPECIFICATION Lithium battery: 2 pcs 3000 mAh Lumen output: 120 lm / W Colour temperature: 2700 K CRI: > 80	CERTIFICATIONS CE certified, tests can be obtained upon request.
PRODUCTION PROCESS Deep drawn aluminium.	DIMMER Yes, 3 steps	PACKAGING TYPE Gift box
MATERIALS Anodized aluminium, LED, ABS	CANOPY N / A	PACKAGING MEASUREMENTS (H x W x D) 23,5 cm x 17,5 cm x 17,5 cm / 10" x 6,9" x 6,9"
		MATERIALS & MAINTENANCE Please see page 486 for materials and care and maintenance instructions.

LUMINOUS INTENSITY DISTRIBUTION (UNIT: CD)

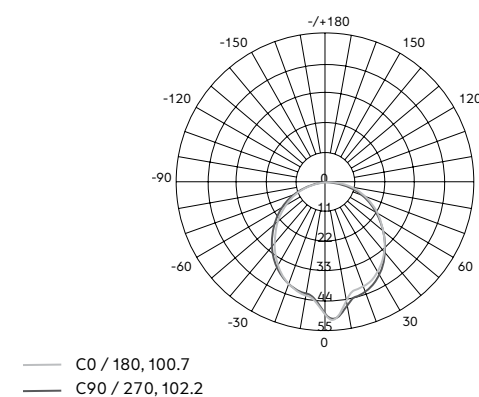

TECHNICAL DRAWING

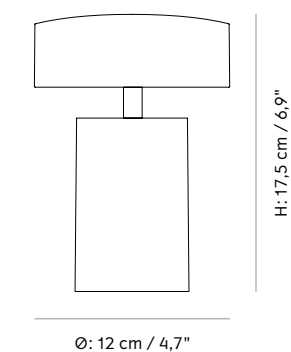

Cast Sconce Wall Lamp

BY TOM CHUNG & JORDAN MURPHY

Cast aluminium lamp with vertical brass arm with mounting plate for wall.

PRODUCT OPTIONS



Black
1250539

Cast Sconce Wall Lamp, by Tom Chung & Jordan Murphy



Cast Sconce Wall Lamp

BY TOM CHUNG & JORDAN MURPHY

STOCK OPTIONS — PRICES IN EUR *Selected combinations up to 2 weeks delivery time.*

SKU	VARIANT	INCL. VAT	EXCL. VAT
1250539	CAST SCONCE WALL LAMP, BLACK	169,95	142,21

TECHNICAL SPECIFICATIONS

PRODUCT TYPE Wall lamp	WEIGHT 0,85 kg / 1,87 lb	CORD MATERIAL AND COLOUR Black PVC cord with matte rubber coating, black plug.
ENVIRONMENT Indoor	VOLTAGE 220 V / 100 - 130 V	CORD LENGTH 200 cm / 78,7"
DIMENSIONS H: 19 cm / 7,5" W: 12 cm / 4,7" D: 18,5 cm / 7,3"	LIGHT SOURCE & ENERGY EFFICIENCY CLASS G9 (Included) 2,5 W A++, A+, A, B, C, D	CLASSIFICATION IP20
COLOURS Black (RAL 9005)	LIGHT SPECIFICATION 220 lm 2800 K Ra > 80	CERTIFICATIONS CE certified, tests can be obtained upon request.
PRODUCTION PROCESS Sand-caste aluminium with painted finish.	DIMMER No. On / Off switch on cord. The lamp can be fitted with a dimmer by an authorised electrician.	PACKAGING TYPE Gift box
MATERIALS Cast aluminium (rough surface), aluminium (reflector) and brushed brass.	CANOPY N / A	PACKAGING MEASUREMENTS (H x W x D) 25,1 cm x 16,1 cm x 22,8 cm / 9,8" x 6,3" x 8,9"
		MATERIALS & MAINTENANCE Please see page 486 for materials and care and maintenance instructions.

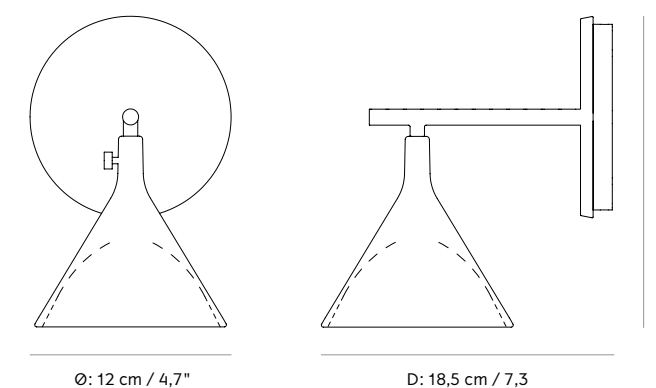

Ø: 12 cm / 4,7"

D: 18,5 cm / 7,3

H: 19 cm / 7,5"

Cast Pendant Shapes 1–3

BY TOM CHUNG & JORDAN MURPHY

Black painted aluminium pendant with flexible PVC cord.

PRODUCT OPTIONS

SHAPE 1



Black
1211539

SHAPE 2



Black
1221539

SHAPE 3



Black
1231539

Cast Pendant, Shape 3, by Tom Chung & Jordan Murphy



Cast Pendant Shapes 1–3

BY TOM CHUNG & JORDAN MURPHY

STOCK OPTIONS — PRICES IN EUR *Selected combinations up to 2 weeks delivery time.*

SKU	VARIANT	INCL. VAT	EXCL. VAT
1211539	CAST, PENDANT, SHAPE 1, BLACK	99,95	83,64
1221539	CAST, PENDANT, SHAPE 2, BLACK	99,95	83,64
1231539	CAST, PENDANT, SHAPE 3, BLACK	99,95	83,64

TECHNICAL SPECIFICATIONS

PRODUCT TYPE
Pendant

ENVIRONMENT
Indoor

DIMENSIONS

Shape 1
H: 12 cm / 4,7"
Ø: 12 cm / 4,7"

Shape 2:
H: 10 cm / 3,9"
Ø: 9 cm / 3,5"

Shape 3
H: 15 cm / 5,9"
Ø: 7 cm / 2,8"

COLOURS
Black (RAL 9005)

PRODUCTION PROCESS
Sand-caste aluminium with painted finish and die-cast aluminium reflector inside the shade.

MATERIALS
Cast aluminium (rough surface), aluminium (reflector) and brushed brass.

WEIGHT
Shape 1: 0,7 kg / 1,5 lb
Shape 2: 0,5 kg / 1,1 lb
Shape 3: 0,8 kg / 1,8 lb

VOLTAGE
220 V / 110 - 130 V

LIGHT SOURCE & ENERGY EFFICIENCY CLASS
G9 (Included)
2,5 W
A++, A+, A, B, C, D

LIGHT SPECIFICATION
220 lm
2800 K
Ra > 80

DIMMER
No. The lamp can be fitted with a dimmer by a certified electrician.

CANOPY
Yes, ABS, black
Ø: 11,5 cm / 4,5"
H: 3,8 cm / 1,5"

CORD MATERIAL AND COLOUR
Soft PVC, black.

CORD LENGTH
400 cm / 157.5"

CLASSIFICATION
IP20

CERTIFICATIONS
CE certified, tests can be obtained upon request.

PACKAGING TYPE
Gift box

PACKAGING MEASUREMENTS (H x W x D)

Shape 1
16,5 cm x 14,5 cm x 14,5 cm / 6,5" x 5,7" x 5,7"

Shape 2
14,5 cm x 12 cm x 12 cm / 5,7" x 4,7" x 4,7"

Shape 3
19 cm x 9,5 cm x 9,5 cm
7,5" x 3,7" x 3,7"

MATERIALS & MAINTENANCE
Please see page 486 for materials and care and maintenance instructions.

SHAPE 1

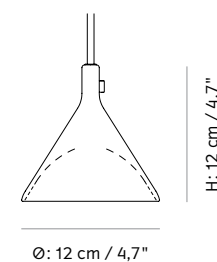

SHAPE 2

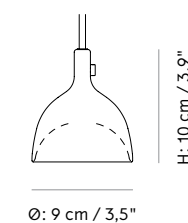

SHAPE 3

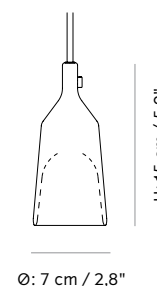

Cast Pendant Shape 4

BY TOM CHUNG & JORDAN MURPHY

Black painted aluminium and powder coated steel frame with soft PVC cord.

PRODUCT OPTIONS

SHAPE 4



Black
1241539

Cast Pendant, Shape 4, by Tom Chung & Jordan Murphy
Cast Pendant, Shape 3, by Tom Chung & Jordan Murphy



Cast Pendant Shape 4

BY TOM CHUNG & JORDAN MURPHY

STOCK OPTIONS — PRICES IN EUR *Selected combinations up to 2 weeks delivery time.*

SKU	VARIANT	INCL. VAT	EXCL. VAT
1241539	CAST, PENDANT, SHAPE 4, BLACK	249,95	209,16

TECHNICAL SPECIFICATIONS

PRODUCT TYPE
Pendant

ENVIRONMENT
Indoor

DIMENSIONS
H: 25 / 32 cm / 9,8" / 12,6"
W: 66 cm / 26"
D: 12 cm / 4,7"

COLOURS
Black (RAL 9005)

PRODUCTION PROCESS
Sand-caste aluminium with painted finish and die-cast aluminium reflector inside the shade.

MATERIALS
Cast aluminium (textured surface) and aluminium (inner reflector) and brushed brass. Powder coated steel frame.

WEIGHT
1,2 kg / 2,6 lb

VOLTAGE
220 V / 110 - 130 V

LIGHT SOURCE & ENERGY EFFICIENCY CLASS
G9 (Included)
2,5 W
A++, A+, A, B, C, D

LIGHT SPECIFICATION
220 lm
2800 K
Ra > 80

DIMMER
No. The lamp can be fitted with a dimmer by a certified electrician.

CANOPY
Yes, ABS, black
Ø: 11,5 cm / 4,5"
H: 3,8 cm / 1,5"

CORD MATERIAL AND COLOUR
Soft PVC, black.

CORD LENGTH
400 cm / 157.5"

CLASSIFICATION
IP20

CERTIFICATIONS
CE certified, tests can be obtained upon request.

PACKAGING TYPE
Gift box

PACKAGING MEASUREMENTS (H x W x D)
25,5 cm x 60 cm x 15 cm / 10" x 23,6" x 5,9"

MATERIALS & MAINTENANCE
Please see page 486 for materials and care and maintenance instructions.

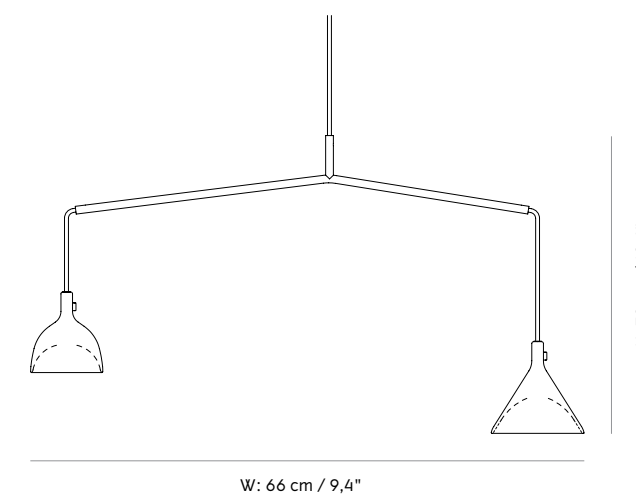

Stone Lamp

BY NORM ARCHITECTS

Grey smoke tinted glass shade set on a stoneware base or opal glass top on sand coloured ceramic base.

PRODUCT OPTIONS



Anthracite
1850159



Sand
1850039

Stone Lamp, Anthracite, by Norm Architects



Stone Lamp

BY NORM ARCHITECTS

STOCK OPTIONS — PRICES IN EUR *Selected combinations up to 2 weeks delivery time.*

SKU	VARIANT	INCL. VAT	EXCL. VAT
1850159	STONE LAMP, ANTHRACITE	249,95	209,16
1850039	STONE LAMP, SAND	249,95	209,16

TECHNICAL SPECIFICATIONS

PRODUCT TYPE
Table lamp

ENVIRONMENT
Indoor

DIMENSIONS
H: 19 cm / 7,5"
Ø: 20 cm / 7,9"

COLOURS
Anthracite
Sand

PRODUCTION PROCESS
Coloured clay (stoneware) or porcelain base with a cord ring made from cast solid brass. The shade is made from mouth-blown glass.

MATERIALS
Clay (stoneware) and coloured glass or porcelain and opal glass.

WEIGHT
1,735 kg / 4 lb

VOLTAGE
220 V / 110 - 130 V

LIGHT SOURCE & ENERGY EFFICIENCY CLASS
E27 (CE) / US (E26) (Not included)
MAX 60 W
A++, A+, A, B, C, D

LIGHT SPECIFICATION
Lumen, Kelvin and Ra value depends on which bulb is used.

DIMMER
Yes, on cord.

CANOPY
N / A

CORD MATERIAL AND COLOUR
Anthracite: textile, black, black plug
Sand: textile, sand, white plug.

CORD LENGTH
200 cm / 78,7"

CLASSIFICATION
IP20

CERTIFICATIONS
CE certified, tests can be obtained upon request.

PACKAGING TYPE
Gift box

PACKAGING MEASUREMENTS (H x W x D)
29,2 cm x 21,7 cm x 21,7 cm / 11,5" x 8,5" x 8,5"

MATERIALS & MAINTENANCE
Please see page 486 for materials and care and maintenance instructions.

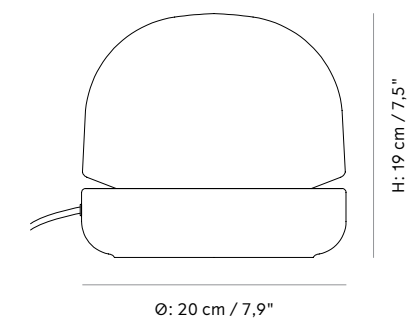

Phare LED Lamp

BY STANISLAW CZARNOCKI

Cordless, portable lamp with diagonal metal base and inbuilt, rechargeable LED light source. The lamp stands on or hangs from its horizontal base, which acts as a weight.

Phare LED Lamp, Black, by Stanislaw Czarnocki



PRODUCT OPTIONS



Burned Red
1755349



Light Grey
1755139



Black
1755539

Phare LED Lamp

BY STANISLAW CZARNOCKI

STOCK OPTIONS — PRICES IN EUR *Selected combinations up to 2 weeks delivery time.*

SKU	VARIANT	INCL. VAT	EXCL. VAT
1755349	PHARE LED LAMP, BURNED RED	149,95	125,48
1755139	PHARE LED LAMP, LIGHT GREY	149,95	125,48
1755539	PHARE LED LAMP, BLACK	149,95	125,48

TECHNICAL SPECIFICATIONS

PRODUCT TYPE
Lamp

ENVIRONMENT
Indoor

DIMENSIONS (CM / IN)
H: 23 cm / 9,1"
W: 13 cm / 5,1"
D: 13,5 cm / 5,3"

COLOURS
Burned red (RAL 8015)
Light grey (RAL 7035)
Black (RAL 9005)

PRODUCTION PROCESS
The shade is made from blown polycarbonate and the base is made from cast aluminium with powder coating.

MATERIALS
Powder coated aluminium (fine texture, matte), polycarbonate, LED.

WEIGHT
1,03 kg / 0,8 lb

VOLTAGE
220 - 240 V / 100 - 130 V

LIGHT SOURCE & ENERGY EFFICIENCY CLASS
Battery: 7 V, 2200 mAh
Light source (Included, not exchangeable): LED, 2,8 W, A+

LIGHT SPECIFICATION
200 lm
2700 K
Ra > 80

DIMMER
No. On / Off switch on the cord.

CANOPY
N / A

CORD MATERIAL AND COLOUR
PVC, black (USB-C cable), black plug.

CORD LENGTH
70 cm / 27,6"

CLASSIFICATION
IP20

CERTIFICATIONS
CE certified, tests can be obtained upon request.

PACKAGING TYPE
Gift box

PACKAGING MEASUREMENTS (H x W x D)
40,8 cm x 50,5 cm x 20,6 cm / 12" x 8,5" x 7,5"

MATERIALS & MAINTENANCE
Please see page 486 for materials and care and maintenance instructions.

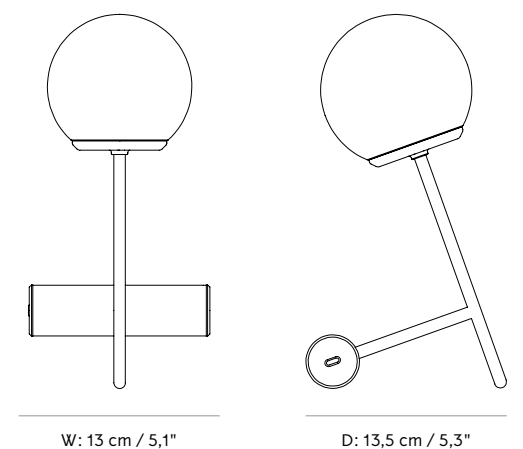

Peek Lamp

BY JONAS WAGELL

Powder coated steel and aluminium lamp with angled shade and textile cord. Directional base and shade for angled lighting.

PRODUCT OPTIONS

TABLE LAMP



Black
1300539



White
1300639

FLOOR LAMP



Black
1320539



White
1320639

Peek Table Lamp, Black, by Jonas Wagell



Peek Lamp

BY JONAS WAGELL

STOCK OPTIONS — PRICES IN EUR *Selected combinations up to 2 weeks delivery time.*

SKU	VARIANT	INCL. VAT	EXCL. VAT
1300539	PEEK TABLE LAMP, BLACK	299,95	251,00
1300639	PEEK TABLE LAMP, WHITE	299,95	251,00
1320539	PEEK FLOOR LAMP, BLACK	449,95	376,52
1320639	PEEK FLOOR LAMP, WHITE	449,95	376,52

TECHNICAL SPECIFICATIONS

PRODUCT TYPE
Table / Floor lamp

ENVIRONMENT
Indoor

DIMENSIONS

Table lamp
H: 52 cm / 20,5"
Ø: 10 cm / 4"

Floor lamp
H: 125 cm / 49,2"
Ø: 13 cm / 5,1"

COLOURS
Black (RAL 9005)
White (RAL 9016)

PRODUCTION PROCESS
Spun aluminium shade with lacquered finish.
Diffuser made from moulded polycarbonate.

MATERIALS
Powder coated stainless steel, aluminium and PC,
(fine texture, matte).

WEIGHT
Table Lamp: 2 kg / 4,4 lb
Floor Lamp: 3,2 kg / 7,1 lb

LIGHT SOURCE & ENERGY EFFICIENCY CLASS
COB LED panel (fixed)
MAX 5 W
LED, A

LIGHT SPECIFICATION
576 - 654 lm
2700 K
Ra > 90

DIMMER
Touch dimmer on stem.

CANOPY
N / A

CORD TYPE
Soft PVC cord, black plug for black, white plug for white.

CORD LENGTH
250 cm / 98,4"

CLASSIFICATION
IP20

CERTIFICATIONS
CE certified, tests can be obtained upon request.

PACKAGING TYPE
Gift box

PACKAGING MEASUREMENTS (H x W x D)

Table lamp
66 cm x 23 cm x 17,5 cm / 25,9" x 9" x 6,9"

Floor lamp
137 cm x 19,5 cm x 21 cm / 53,9" x 7,7" x 8,2"

MATERIALS & MAINTENANCE
Please see page 486 for materials and care and maintenance instructions.

TABLE LAMP

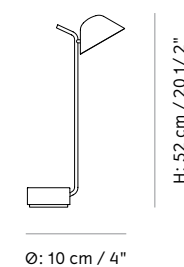

FLOOR LAMP

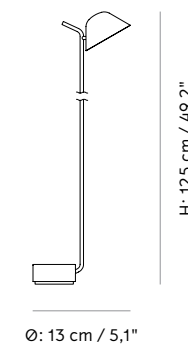

Dancing Pendant

BY ISKOS-BERLIN

Large pleated pendant with a recycled polyester felt shade and textile cord.

PRODUCT OPTIONS



Off White
1600659

Dancing Pendant, by Iskos-Berlin
Snaregade Dining Table, Rectangular, Black Steel / Charcoal Linoleum,
by Norm Architects
Harbour Dining Side Chair, Dark Stained Oak / Nuance 40782,
by Norm Architects



Dancing Pendant

BY ISKOS-BERLIN

STOCK OPTIONS — PRICES IN EUR *Selected combinations up to 2 weeks delivery time.*

SKU	VARIANT	INCL. VAT	EXCL. VAT
1600659	DANCING PENDANT, OFF WHITE	749,95	627,56

TECHNICAL SPECIFICATIONS

PRODUCT TYPE
Pendant

WEIGHT
2,6 kg / 5,7 lb

CORD MATERIAL AND COLOUR
Textile, white.

ENVIRONMENT
Indoor

VOLTAGE
220 V / 110 - 130 V

CORD LENGTH
300 cm / 118,1"

DIMENSIONS
H: 58 cm / 22,8"
Ø: 95 cm / 37,4

LIGHT SOURCE & ENERGY EFFICIENCY CLASS
E27 (CE) / US (E26) (Not included)
MAX 60 W
A++, A+, A, B, C, D

CLASSIFICATION
IP20

COLOURS
Off white

LIGHT SPECIFICATION
Lumen, Kelvin and Ra value depends on which bulb is used.

CERTIFICATIONS
CE compliant.

PRODUCTION PROCESS
Pressed PET felt is made from high quality felt fibres which are mechanically pressed together in a wooden mould using heat and moisture.

DIMMER
No. The lamp can be connected to a dimmer system.

PACKAGING TYPE
Brown box

MATERIALS
Felt

CANOPY
Yes (Cone Shape), ABS, white
Ø: 9 cm / 3,5"
H: 9 cm / 3,5"

PACKAGING MEASUREMENTS (H x W x D)
100 cm x 95 cm x 59 cm / 39,4" x 37,4" x 23,2"

MATERIALS & MAINTENANCE
Please see page 486 for materials and care and maintenance instructions.

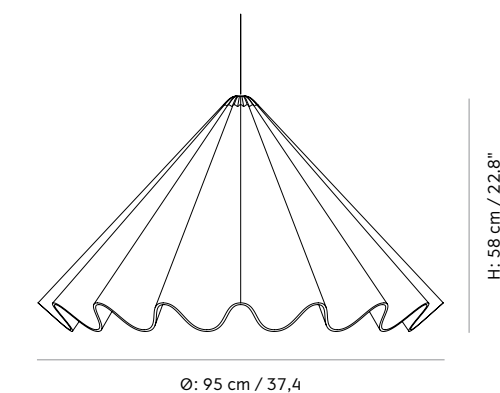

Socket Occasional Lamp

BY NORM ARCHITECTS

Cylindrical brushed brass lamp with round opal glass bulb and black textile cord.

PRODUCT OPTIONS



Brushed Brass
1750839

Socket Occasional Lamp, by Norm Architects



Socket Occasional Lamp

BY NORM ARCHITECTS

STOCK OPTIONS — PRICES IN EUR *Selected combinations up to 2 weeks delivery time.*

SKU	VARIANT	INCL. VAT	EXCL. VAT
1750839	SOCKET, OCCASIONAL LAMP, BRUSHED BRASS	199,95	167,32

TECHNICAL SPECIFICATIONS

PRODUCT TYPE
Table lamp

WEIGHT
1,42 kg / 3,1 lb

CORD MATERIAL AND COLOUR
Textile, black, black plug.

ENVIRONMENT
Indoor

VOLTAGE
200 - 265 V / 100 - 130 V

CORD LENGTH
200 cm

DIMENSIONS
H: 18 cm / 7,1"
Ø: 6,8 cm / 2,7"

LIGHT SOURCE & ENERGY EFFICIENCY CLASS
E27 (Included) 5 W, A
MAX 60 W
Lifespan: 30.000 h

CLASSIFICATION
IP20

COLOURS
Brushed brass

LIGHT SPECIFICATION
400 lm
2700 K
Ra > 95

CERTIFICATIONS
CE certified, tests can be obtained upon request.

PRODUCTION PROCESS
Sand-caste brass with a brushed finish. The brass is lightly varnished to maintain its natural lustre.

DIMMER
Yes, on cord.

PACKAGING TYPE
Gift box

MATERIALS
Solid brass.

CANOPY
N / A

PACKAGING MEASUREMENTS (H x W x D)
14,5 cm x 25,5 cm x 25,6 cm / 5,7" x 10" x 10"

MATERIALS & MAINTENANCE
Please see page 486 for materials and care and maintenance instructions.

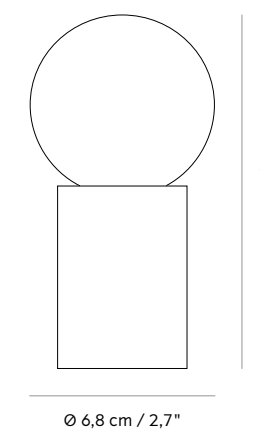

Ø 6,8 cm / 2,7"

Globe Bulb

BY MENU

Energy-saving bulb in two versions: opal glass LED bulb with frosted finish and clear glass LED bulb with dim to warm function.

The effect known as dim to warm lowers the colour temperature of an LED bulb when dimmed. The lower the brightness, the warmer (more orange) the colour to create a more natural ambience reminiscent of the sky at sunset. Dimming does not alter the colour temperature, but rather simply lowers the light level.

PRODUCT OPTIONS

GLOBE BULB LED 95



LED Bulb, Dimmable, Opal, 95
2500639



LED Bulb, DrW, Clear 95
2610039

GLOBE BULB LED 125



LED Bulb, DrW, Clear 125
2611039

Globe Bulb

BY MENU

STOCK OPTIONS — PRICES IN EUR *Selected combinations up to 2 weeks delivery time.*

SKU	VARIANT	INCL. VAT	EXCL. VAT
2500639	GLOBE BULB, LED, 95, OPAL, E27	39,95	33,43
2610039	GLOBE BULB, LED DTW, 95, CLEAR, E27	29,95	25,06
2611039	GLOBE BULB, LED DTW, 125, CLEAR, E27	49,95	41,80

TECHNICAL SPECIFICATIONS

PRODUCT TYPE

LED bulb

ENVIRONMENT

Indoor

DIMENSIONS

Globe Bulb, LED, 95
Ø: 9,5 cm / 3.7"

Globe Bulb, LED, 125
Ø: 12,5 cm / 4.9"

MATERIALS

Clear glass, opal matte glass, LED filament.

WEIGHT

Globe Bulb, LED, 95: 0,06 kg / 0,14 lb
Globe Bulb, LED, 125: 0,1 kg / 0,2 lb

VOLTAGE

220 - 240 V / 110 - 130 V

LIGHT SOURCE & ENERGY EFFICIENCY CLASS

Opal (95)
E27 (CE), 5 W

Clear (95 / 125)
E27 (CE), 4 W

LIGHT SPECIFICATION

Opal (95)
400 lm
2700 K
Ra > 95

Clear (95 / 125)
400 lm
2000 - 2700 K
Ra > 95

DIMMER

Globe Bulb, LED, 95, Opal: Standard dimming
Globe Bulb, LED, 95, Clear: Dim to Warm
Globe Bulb, LED, 125, Clear: Dim to Warm

CANOPY

N / A

CORD MATERIAL AND COLOUR

N / A

CORD LENGTH

N / A

CLASSIFICATION

IP20

CERTIFICATIONS

CE certified, tests can be obtained upon request.

PACKAGING TYPE

Gift box

PACKAGING MEASUREMENTS (H x W x D)

Globe Bulb, LED, 95, Opal
14,5 cm x 10 cm x 10 cm / 5,7" x 3,9" x 3,9"

Globe Bulb, LED, 95, Clear
20 cm x 13,5 cm x 13,5 cm / 7,9" x 5,3" x 5,3"

Globe Bulb, LED, 125, Clear
24 cm x 16,5 cm x 16,5 cm / 9,4" x 6,5" x 6,5"

MATERIALS & MAINTENANCE

Please see page 486 for materials and care and maintenance instructions.

GLOBE BULB LED 95

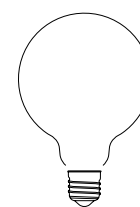

Ø: 9,5 cm / 3.7"

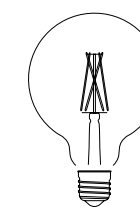

Ø: 9,5 cm / 3.7"

GLOBE BULB LED 125

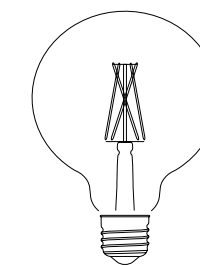

Ø: 12,5 cm / 4.9"

Reverse Table Lamp

BY ALEKSANDAR LAZIC

Table lamp with conical travertine base and bronzed anodised aluminium shade. A dimmer switch fitted on top of the lamp controls the dim to warm LED light.

PRODUCT OPTIONS



Reverse Table Lamp, Bronzed Brass
1410619

Reverse Table Lamp, by Aleksandar Lazic



Reverse Table Lamp

BY ALEKSANDAR LAZIC

STOCK OPTIONS — PRICES IN EUR *Selected combinations up to 2 weeks delivery time.*

SKU	VARIANT	INCL. VAT	EXCL. VAT
1410619	REVERSE TABLE LAMP, TRAVERTINE, BRONZED BRASS (NEW)	549,95	460,20

TECHNICAL SPECIFICATIONS

PRODUCT TYPE Table lamp	WEIGHT 3,64 kg / 5,7 lb	CORD MATERIAL AND COLOUR Flexible PVC cable, black, black plug.
ENVIRONMENT Indoor	VOLTAGE 110 - 240 V, adaptor input 24 V	CORD LENGTH 200 cm / 78,7"
DIMENSIONS H: 30 cm / 11,8" Ø: 24 / 10 cm / 9,4" / 3,9"	LIGHT SOURCE & ENERGY EFFICIENCY CLASS Watt 6 W, built-in LED, dimmable, A	CLASSIFICATION IP20
PRODUCTION PROCESS Spun aluminium shade with anodized colour, milled aluminium knob, and hand-cut and raw polished travertine base.	LIGHT SPECIFICATION 560 lm 2200 - 2940 K RA(CRI) > 85	CERTIFICATIONS CE certified, tests can be obtained upon request.
COLOURS Beige and bronzed brass.	DIMMER Yes, on top of shade.	PACKAGING TYPE Gift box
MATERIALS Travertine, aluminium, PMMA, adaptor with CE, UL and GB plug.	CANOPY N / A	PACKAGING MEASUREMENTS (H x W x D) 36,5 cm x 31 cm x 32,5 cm / 14,4" x 12,2" x 12,8"
		MATERIALS & MAINTENANCE Please see page 486 for materials and care and maintenance instructions.

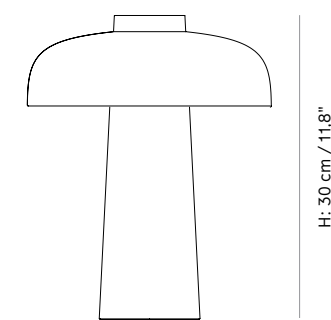

Ø: 24 / 10 cm / 9,4" / 3,9"

Hashira Table Lamp

BY NORM ARCHITECTS

Translucent, cylindrical fabric shade with metal frame, textile cord and dimmer switch.

PRODUCT OPTIONS



Hashira Table Lamp
1500059

Hashira Table Lamp, by Norm Architects
Androgyne Lounge Table, by Danielle Siggerud



Hashira Table Lamp

BY NORM ARCHITECTS

STOCK OPTIONS — PRICES IN EUR *Selected combinations up to 2 weeks delivery time.*

SKU	VARIANT	INCL. VAT	EXCL. VAT
1500059	HASHIRA TABLE LAMP (NEW)	349,95	292,84

TECHNICAL SPECIFICATIONS

PRODUCT TYPE Table lamp	WEIGHT 1,88 kg / 4,14 lb	CORD MATERIAL AND COLOUR Black textile, black plug.
ENVIRONMENT Indoor	VOLTAGE 220 – 240 V / 110 V	CORD LENGTH 200 cm / 78,7"
DIMENSIONS H: 49,5 cm / 19,5" Ø: 18 cm / 7,1"	LIGHT SOURCE & ENERGY EFFICIENCY CLASS E27 (CE) - 1 pcs E26 (US) - 1 pcs	CLASSIFICATION IP20
PRODUCTION PROCESS Welded steel frame with a hand-made shade and sandblasted wood base.	LIGHT SPECIFICATION N / A	CERTIFICATIONS CE certified, tests can be obtained upon request.
COLOURS White, ash	DIMMER Yes	PACKAGING TYPE Gift box
MATERIALS Steel, linen, PS plastic, ash. Thickness of line may vary giving a slightly different light.	CANOPY N / A	PACKAGING MEASUREMENTS (H x W x D) 53,5 cm x 24 cm x 24 cm / 21,1" x 9,4" x 9,4"
		MATERIALS & MAINTENANCE Please see page 486 for materials and care and maintenance instructions.

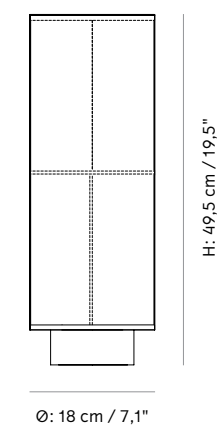

Hashira Floor Lamp

BY NORM ARCHITECTS

Translucent, cylindrical fabric shade with metal frame, textile cord and dimmer switch.

PRODUCT OPTIONS



Hashira Floor Lamp
1501059

Hashira Floor Lamp, by Norm Architects
Gravel Rug, Ivory, by Nina Bruun
Harbour Lounge Chair, Natural Oak / Savanna 222/Nuance Light Grey, by Norm Architects



Hashira Floor Lamp

BY NORM ARCHITECTS

STOCK OPTIONS — PRICES IN EUR *Selected combinations up to 2 weeks delivery time.*

SKU	VARIANT	INCL. VAT	EXCL. VAT
1501059	HASHIRA FLOOR LAMP (NEW)	669,95	560,61

TECHNICAL SPECIFICATIONS

PRODUCT TYPE Floor lamp	WEIGHT 5,22 kg / 11,51 lb	CORD MATERIAL AND COLOUR Black textile, black plug.
ENVIRONMENT Indoor	VOLTAGE 220 – 240 V / 110 V	CORD LENGTH 300 cm / 118"
DIMENSIONS H: 83 cm / 32,7" Ø: 30 cm / 11,8"	LIGHT SOURCE & ENERGY EFFICIENCY CLASS E27 (CE) - 2 pcs E26 (US) - 2 pcs	CLASSIFICATION IP20
PRODUCTION PROCESS Welded steel frame with a hand-made shade and sandblasted wood base.	LIGHT SPECIFICATION Only On / Off switch on cord.	CERTIFICATIONS CE certified, tests can be obtained upon request.
COLOURS White, ash	DIMMER Only On / Off	PACKAGING TYPE Brown box
MATERIALS Steel, linen, PS plastic, ash Thickness of line may vary giving a slightly different light.	CANOPY N / A	PACKAGING MEASUREMENTS (H x W x D) 37 cm x 37 cm x 88 cm / 14,6" x 14,6" x 34,6"
MATERIALS & MAINTENANCE Please see page 486 for materials and care and maintenance instructions.		

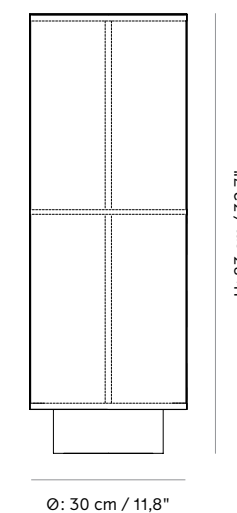

Hashira Pendant

BY NORM ARCHITECTS

Translucent, cylindrical fabric shade with metal frame, textile cord and dimmer switch.

PRODUCT OPTIONS

SMALL



Hashira Pendant, Small
1502059

LARGE



Hashira Pendant, Large
1503059

Hashira Pendant, Small, by Norm Architects
Hashira Pendant, Large, by Norm Architects



Hashira Pendant

BY NORM ARCHITECTS

STOCK OPTIONS — PRICES IN EUR *Selected combinations up to 2 weeks delivery time.*

SKU	VARIANT	INCL. VAT	EXCL. VAT
1502059	HASHIRA PENDANT, SMALL (NEW)	269,95	225,89
1503059	HASHIRA PENDANT, LARGE (NEW)	549,95	460,20

TECHNICAL SPECIFICATIONS

PRODUCT TYPE
Pendant

ENVIRONMENT
Indoor

DIMENSIONS

Small
H: 45 cm / 17,7"
Ø: 18 cm / 7,1"

Large
H: 75 cm / 29,5"
Ø: 30 cm / 11,8"

PRODUCTION PROCESS
Welded steel frame with a hand-made shade.

COLOURS
White, bronzed brass

MATERIALS
Steel, linen, PS plastic.
Thickness of line may vary giving a slightly different light.

WEIGHT
Small: 1,28 kg / 2,82 lb
Large: 2,35 kg / 5,18 lb

VOLTAGE
220 - 240 V / 110 V

LIGHT SOURCE & ENERGY EFFICIENCY CLASS
E27 (CE) - 1 pcs (Small), 2 pcs (Large)
E26 (US) - 1 pcs (Small), 2 pcs (Large)

LIGHT SPECIFICATION
N / A

DIMMER
No. The lamp can be connected to a dimmer system.

CANOPY
Yes, ABS, black
Ø: 11,5 cm / 4,5"
H: 3,8 cm / 1,5"

CORD MATERIAL AND COLOUR
Textile, black, with safe wire.

CORD LENGTH
500 cm / 197"

CLASSIFICATION
IP20

CERTIFICATIONS
CE certified, tests can be obtained upon request.

PACKAGING TYPE
Small: Gift box
Large: Brown box

PACKAGING MEASUREMENTS (H x W x D)

Small
24 cm x 24 cm x 50 cm / 9,4" x 9,4" x 19,7"

Large
37 cm x 37 cm x 80 cm
14,6" x 14,6" x 31,5"

MATERIALS & MAINTENANCE
Please see page 486 for materials and care and maintenance instructions.

SMALL

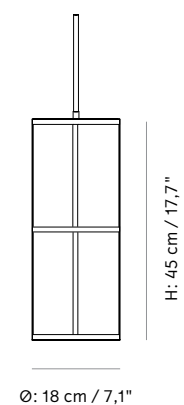

LARGE

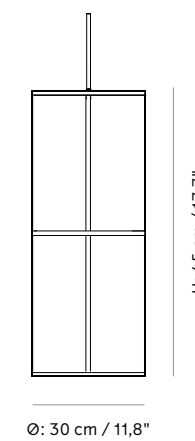

Hashira Pendant, Cluster

BY NORM ARCHITECTS

Translucent, cylindrical fabric shade with metal frame, textile cord and dimmer switch.

PRODUCT OPTIONS

SMALL



Hashira Pendant, Cluster, Small
1504059

LARGE



Hashira Pendant, Cluster, Large
1505059

Hashira Pendant, Cluster, Large, by Norm Architects
Hashira Pendant, Cluster, Small, by Norm Architects



Hashira Pendant, Cluster

BY NORM ARCHITECTS

STOCK OPTIONS — PRICES IN EUR *Selected combinations up to 2 weeks delivery time.*

SKU	VARIANT	INCL. VAT	EXCL. VAT
1504059	HASHIRA PENDANT, CLUSTER, SMALL (NEW)	669,95	560,61
1505059	HASHIRA PENDANT, CLUSTER, LARGE (NEW)	1.349,95	1.129,64

TECHNICAL SPECIFICATIONS

PRODUCT TYPE Pendant	WEIGHT Small: 3,48 kg / 7,67 lb Large: 7,26 kg / 16 lb	CORD LENGTH 500 cm / 197"
ENVIRONMENT Indoor	VOLTAGE 220 - 240 V / 110 V	CLASSIFICATION IP20
DIMENSIONS Small H: 45 cm / 17,7" Ø: 37 cm / 14,6" Large H: 75 cm / 29,5" Ø: 61,5 cm / 24,2"	LIGHT SOURCE & ENERGY EFFICIENCY CLASS E27 (CE) - 3 pcs (Small), 6 pcs (Large) E26 (US) - 3 pcs (Small), 6 pcs (Large)	CERTIFICATIONS CE certified, tests can be obtained upon request.
PRODUCTION PROCESS Welded steel frame with a hand-made shade.	LIGHT SPECIFICATION N / A	PACKAGING TYPE Brown box
COLOURS White, bronzed brass.	DIMMER No. The lamp can be connected to a dimmer system.	PACKAGING MEASUREMENTS (H x W x D) Small 43,5 cm x 43,5 cm x 49 cm / 9,4" x 9,4" x 19,3" Large 67,5 cm x 67,5 cm x 78 cm / 26,6" x 26,6" x 30,7"
MATERIALS Steel, linen, PS plastic. Thickness of line may vary giving a slightly different light.	CANOPY Yes, ABS, black Ø: 11,5 cm / 4,5" H: 3,8 cm / 1,5"	MATERIALS & MAINTENANCE Please see page 486 for materials and care and maintenance instructions.
	CORD MATERIAL AND COLOUR Textile, black, with safe wire.	

SMALL

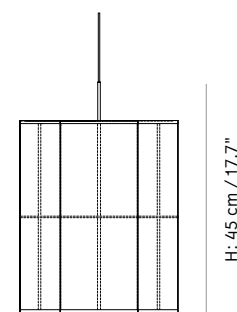

Ø: 37 cm / 14,6"

H: 45 cm / 17,7"

LARGE

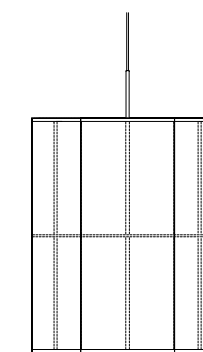

Ø: 61,5 cm / 24,2"

H: 75 cm / 29,5"

3.

Accessories

POV Candleholder Wall

BY NOTE DESIGN STUDIO

Wall-mounted, hexagonal-shaped powder coated steel frame centred with tealight holder.

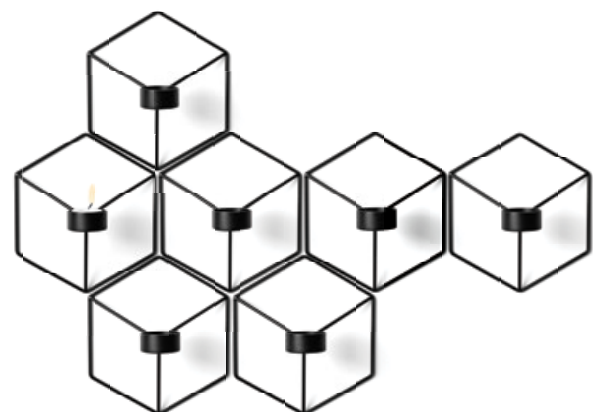

POV Candleholder Wall, White, by Note Design Studio



PRODUCT OPTIONS



Black
4766539



White
4766639

POV Candleholder Wall

BY NOTE DESIGN STUDIO

STOCK OPTIONS — PRICES IN EUR *Selected combinations up to 2 weeks delivery time.*

SKU	VARIANT	INCL. VAT	EXCL. VAT
4766539	POV CANDLEHOLDER WALL, BLACK	39,95	33,43
4766639	POV CANDLEHOLDER WALL, WHITE	39,95	33,43

TECHNICAL SPECIFICATIONS

PRODUCT TYPE
Candleholder

WEIGHT
0,15 kg / 0,33 lb

PACKAGING TYPE
Gift box

PRODUCTION PROCESS
The candleholder is made of welded powder coated steel wire.

MATERIALS
Powder coated steel.

PACKAGING MEASUREMENTS (H x W x D)
19 cm x 22 cm x 11,5 cm / 7,48" x 8,66" x 4,53"

DIMENSIONS
H: 21 cm / 8,3"
W: 18,5 cm / 7,3"
D: 11 cm / 4,3"

COLOURS
Black (RAL 9005)
White (RAL 9016)

MATERIALS & MAINTENANCE
Please see page 486 for materials and care and maintenance instructions.

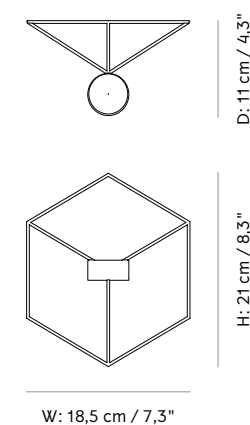

POV Circle Candleholder

BY NOTE DESIGN STUDIO

Solid brass or powder coated steel wall-mounted candlestick holder.

PRODUCT OPTIONS

SMALL



Black
4811539



Brass
4811839

LARGE



Black
4812539



Brass
4812839

POV Circle Candleholder, Large, Black, by Note Design Studio
POV Circle Candleholder, Small, Black, by Note Design Studio



POV Circle Candleholder

BY NOTE DESIGN STUDIO

STOCK OPTIONS — PRICES IN EUR *Selected combinations up to 2 weeks delivery time.*

SKU	VARIANT	INCL. VAT	EXCL. VAT
4811539	POV CIRCLE CANDLEHOLDER, S, BLACK	39,95	33,43
4811839	POV CIRCLE CANDLEHOLDER, S, BRASS	69,95	58,53
4812539	POV CIRCLE CANDLEHOLDER, L, BLACK	69,95	58,53
4812839	POV CIRCLE CANDLEHOLDER, L, BRASS	99,95	83,64

TECHNICAL SPECIFICATIONS

PRODUCT TYPE
Candleholder

PRODUCTION PROCESS
The brass version is made using solid brass wires with silver soldering.
The black version is made using welded powder coated steel wire.

DIMENSIONS

Small
Ø: 20 cm / 7,9"
D: 10 cm / 3,9"

Large
Ø: 44 cm / 17,3"
D: 11 cm / 4,3"

WEIGHT
Small: 0,12 kg / 0,26 lb
Large: 0,32 kg / 0,71 lb

MATERIALS
Powder coated steel or solid brass.

COLOURS
Black (RAL 9005)
Brass

PACKAGING TYPE
Gift box

PACKAGING MEASUREMENTS (H x W x D)

Small
20,5 cm x 20,5 cm x 13,5 cm / 8,1" x 8,1" x 4,3"

Large
44,5 cm x 44,5 cm x 13,5 cm / 17,5" x 17,5" x 4,3"

MATERIALS & MAINTENANCE
Please see page 486 for materials and care and maintenance instructions.

POV CIRCLE CANDLEHOLDER, SMALL

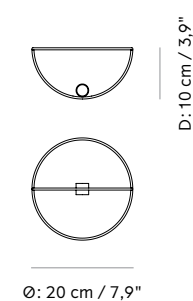

POV CIRCLE CANDLEHOLDER, LARGE

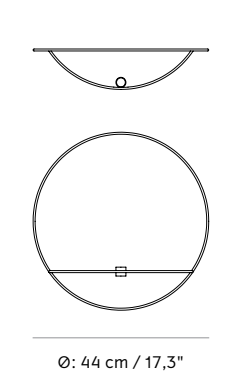

POV Circle Tealight Candleholder

BY NOTE DESIGN STUDIO

Solid brass or powder coated steel wall-mounted tealight holder.

PRODUCT OPTIONS

SMALL

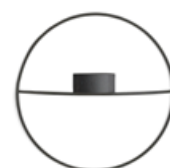

Black
4813539



Brass
4813839

LARGE



Black
4814539



Brass
4814839

POV Circle Tealight Candleholder, Large, Brass, by Note Design Studio



POV Circle Tealight Candleholder

BY NOTE DESIGN STUDIO

STOCK OPTIONS — PRICES IN EUR *Selected combinations up to 2 weeks delivery time.*

SKU	VARIANT	INCL. VAT	EXCL. VAT
4813539	POV CIRCLE, TEALIGHT CANDLEHOLDER, S, BLACK	39,95	33,43
4813839	POV CIRCLE, TEALIGHT CANDLEHOLDER, S, BRASS	69,95	58,53
4814539	POV CIRCLE, TEALIGHT CANDLEHOLDER, L, BLACK	69,95	58,53
4814839	POV CIRCLE, TEALIGHT CANDLEHOLDER, L, BRASS	99,95	83,64

TECHNICAL SPECIFICATIONS

PRODUCT TYPE
Candleholder

PRODUCTION PROCESS
The brass version is made using solid brass wires with silver soldering.
The black version is made using welded powder coated steel wire.

DIMENSIONS

Small
Ø: 20 cm / 7,9"
D: 11 cm / 4,3"

Large
Ø: 44 cm / 17,3"
D: 11 cm / 4,3"

WEIGHT
Small: 0,18 kg / 0,4 lb
Large: 0,37 kg / 0,82 lb

MATERIALS
Powder coated steel or solid brass.

COLOURS
Black (RAL 9005)
Brass

PACKAGING TYPE
Gift box

PACKAGING MEASUREMENTS (H x W x D)

Small
21 cm x 21 cm x 13,5 cm / 8,27" x 8,27" x 5,31"

Large
44,5 cm x 44,5 cm x 13,5 cm / 17,52" x 17,52" x 5,31"

MATERIALS & MAINTENANCE
Please see page 486 for materials and care and maintenance instructions.

POV CIRCLE TEALIGHT CANDLEHOLDER, SMALL

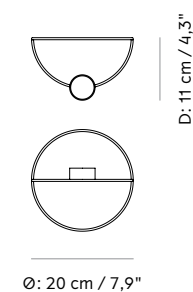

POV CIRCLE TEALIGHT CANDLEHOLDER, LARGE

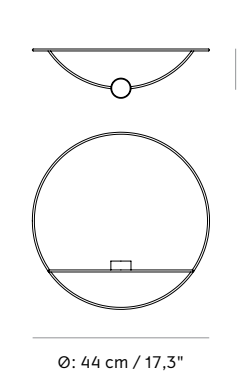

POV Circle Vase/Candleholder

BY NOTE DESIGN STUDIO

Solid brass or powder coated steel wall-mounted vase / candleholder.

PRODUCT OPTIONS

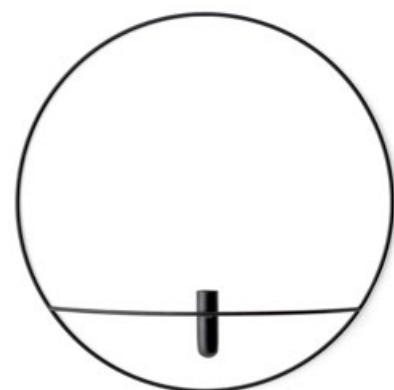

Black
4815539



Brass
4815839

POV Circle Vase / Candleholder, Black, by Note Design Studio



POV Circle Vase/Candleholder

BY NOTE DESIGN STUDIO

STOCK OPTIONS — PRICES IN EUR *Selected combinations up to 2 weeks delivery time.*

SKU	VARIANT	INCL. VAT	EXCL. VAT
4815539	POV CIRCLE, VASE / CANDLEHOLDER, L, BLACK	69,95	58,53
4815839	POV CIRCLE, VASE / CANDLEHOLDER, L, BRASS	99,95	83,64

TECHNICAL SPECIFICATIONS

PRODUCT TYPE
Vase and candleholder

PRODUCTION PROCESS
The brass version is made using solid brass wires with silver soldering.
The black version is made using welded powder coated steel wire.

DIMENSIONS
Ø: 44 cm / 17,3"
D: 10 cm / 3,9"

WEIGHT
0,34 kg / 0,75 lb

MATERIALS
Powder coated steel or solid brass.

COLOURS
Black (RAL 9005)
Brass

PACKAGING TYPE
Gift box

PACKAGING MEASUREMENTS (H x W x D)
45 cm x 45 cm x 11 cm / 17,72" x 17,72" x 4,33"

MATERIALS & MAINTENANCE
Please see page 486 for materials and care and maintenance instructions.

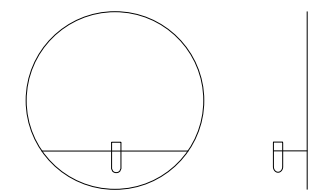

Ø: 44 cm / 17,3" D: 10 cm / 3,9"

POV Oval Vase/Candleholder

BY NOTE DESIGN STUDIO

Solid brass or powder coated steel wall-mounted vase / candleholder.

PRODUCT OPTIONS



Black
4816539



Brass
4816839

POV Oval Vase / Candleholder, Brass, by Note Design Studio



POV Oval Vase/Candleholder

BY NOTE DESIGN STUDIO

STOCK OPTIONS — PRICES IN EUR *Selected combinations up to 2 weeks delivery time.*

SKU	VARIANT	INCL. VAT	EXCL. VAT
4816539	POV OVAL VASE / CANDLEHOLDER, BLACK	69,95	58,53
4816839	POV OVAL VASE / CANDLEHOLDER, BRASS	99,95	83,64

TECHNICAL SPECIFICATIONS

PRODUCT TYPE
Vase and candleholder

PRODUCTION PROCESS
The brass version is made using solid brass wires with silver soldering.
The black version is made using welded powder coated steel wire.

DIMENSIONS
H: 44 cm / 17,3"
W: 22 cm / 8,7"
D: 10 cm / 3,9"

WEIGHT
Black: 0,275 kg / 0,61 lb
Brass: 0,3 kg / 0,66 lb

MATERIALS
Powder coated steel or solid brass.

COLOURS
Black (RAL 9005)
Brass

PACKAGING TYPE
Gift box

PACKAGING MEASUREMENTS (H x W x D)
44,5 cm x 21 cm x 11,5 cm / 17,52" x 8,27" x 4,53"

MATERIALS & MAINTENANCE
Please see page 486 for materials and care and maintenance instructions.

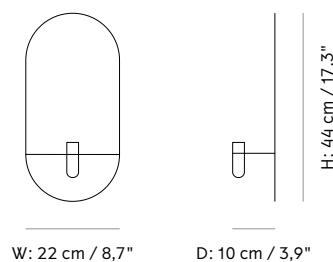

POV Oval Tealight Candleholder

BY NOTE DESIGN STUDIO

Solid brass or powder coated steel wall-mounted tealight candleholder.

POV Oval Tealight Candleholder, Black, by Note Design Studio



PRODUCT OPTIONS



Black
4817539



Brass
4817839

POV Oval Tealight Candleholder

BY NOTE DESIGN STUDIO

STOCK OPTIONS — PRICES IN EUR *Selected combinations up to 2 weeks delivery time.*

SKU	VARIANT	INCL. VAT	EXCL. VAT
4817539	POV OVAL TEALIGHT CANDLEHOLDER, L, BLACK	69,95	58,53
4817839	POV OVAL TEALIGHT CANDLEHOLDER, L, BRASS	99,95	83,64

TECHNICAL SPECIFICATIONS

PRODUCT TYPE
Candleholder

PRODUCTION PROCESS
The brass version is made using solid brass wires with silver soldering.
The black version is made using welded powder coated steel wire.

DIMENSIONS
H: 44 cm / 17,3"
W: 22 cm / 8,7"
D: 11 cm / 4,33"

WEIGHT
Black: 0,285 kg / 0,63 lb
Brass: 0,31 kg / 0,68 lb

MATERIALS
Powder coated steel or solid brass.

COLOURS
Black (RAL 9005)
Brass

PACKAGING TYPE
Gift box

PACKAGING MEASUREMENTS (H x W x D)
44,5 cm x 13 cm x 21 cm / 17,52" x 5,12 x 8,27"

MATERIALS & MAINTENANCE
Please see page 486 for materials and care and maintenance instructions.

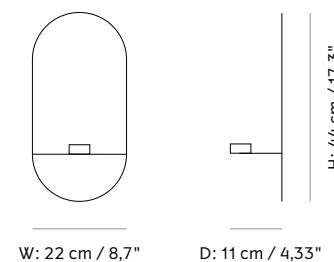

Échasse Vase

BY THERESA RAND

Mouth-blown smoke or clear glass vase set on brushed or bronzed brass base. Available in three sizes.

Tearoom Lounge Chair, Dedar Alexander 137 Dorure, by Nick Ross
Plinth Cubic, Nero Marquina Marble, by Norm Architects
Échasse Vase, Medium, Smoke Glass / Brushed Brass, by Theresa Rand



PRODUCT OPTIONS

SMALL



Clear / Bronzed Brass
4789039



Smoke / Brushed Brass
4795949

MEDIUM



Smoke / Brushed Brass
4796949

LARGE



Smoke / Brushed Brass
4797949

Échasse Vase

BY THERESA RAND

STOCK OPTIONS — PRICES IN EUR *Selected combinations up to 2 weeks delivery time.*

SKU	VARIANT	INCL. VAT	EXCL. VAT
4789039	ÉCHASSE VASE, S, CLEAR GLASS / BRONZED BRASS	169,95	142,21
4795949	ÉCHASSE VASE, S, SMOKE GLASS / BRUSHED BRASS	169,95	142,21
4796949	ÉCHASSE VASE, M, SMOKE GLASS / BRUSHED BRASS	299,95	251,00
4797949	ÉCHASSE VASE, L, SMOKE GLASS / BRUSHED BRASS	499,95	418,36

TECHNICAL SPECIFICATIONS

PRODUCT TYPE
Vase

PRODUCTION PROCESS
The base is made from solid brass rods with silver solidering. The surface is lightly brushed or bronzed. Glass is coloured or clear and mouth-blown.

WEIGHT
Small: 0,89 kg / 1,96 lb
Medium: 2,14 kg / 4,72 lb
Large: 5,63 kg / 12,41 lb
Weight may vary due to the mouth-blown glass.

MATERIALS
Solid brass, glass.

DIMENSIONS

Small
H: 28 cm / 11"
Ø: 15 cm / 5,9"

Medium
H: 45 cm / 17,7"
Ø: 22 cm / 8,7"

Large
H: 60 cm / 23,6"
Ø: 30 cm / 11,8"

COLOURS
Smoke / Brushed brass
Clear / Bronzed brass

PACKAGING TYPE
Gift box

PACKAGING MEASUREMENTS (H x W x D)

Small
40,7 cm x 19 cm x 19 cm / 7,5" x 16,0" x 16,0"

Medium
69 cm x 31,5 cm x 31,5 cm / 12,4 x 27,2" x 12,4"

Large
87 cm x 39 cm x 39 cm / 34,3" x 15,4" x 15,4"

MATERIALS & MAINTENANCE
Please see page 486 for materials and care and maintenance instructions.

ÉCHASSE VASE SMALL

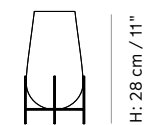

Ø: 15 cm / 5,9"

H: 28 cm / 11"

ÉCHASSE VASE MEDIUM

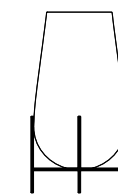

Ø: 22 cm / 8,7"

H: 45 cm / 17,7"

ÉCHASSE VASE LARGE

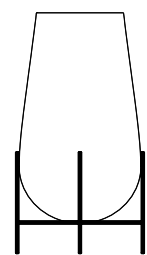

Ø: 30 cm / 11,8"

H: 60 cm / 23,6"

Échasse Bowl

BY THERESA RAND

Mouth-blown smoke glass bowl set on brushed brass bas.

PRODUCT OPTIONS

SMALL



Smoke
4799949

LARGE



Smoke
4798949

Échasse Bowl, Small, Smoke Glass / Brushed Brass, by Theresa Rand



Échasse Bowl

BY THERESA RAND

STOCK OPTIONS — PRICES IN EUR *Selected combinations up to 2 weeks delivery time.*

SKU	VARIANT	INCL. VAT	EXCL. VAT
4799949	ÉCHASSE BOWL, S, SMOKE GLASS / BRUSHED BRASS	99,95	83,64
4798949	ÉCHASSE BOWL, L, SMOKE GLASS / BRUSHED BRASS	269,95	225,89

TECHNICAL SPECIFICATIONS

PRODUCT TYPE

Bowl

PRODUCTION PROCESS

The base is made from solid brass rods with silver solidering. The surface is lightly brushed or bronzed. Glass is coloured or clear and mouth-blown.

DIMENSIONS

Small
H: 13 cm / 5,1"
Ø: 15 cm / 5,9"

Large
H: 14 cm / 5,5"
Ø: 29,5 cm / 11,6"

WEIGHT

Small: 0,6 kg / 1,32 lb
Large: 2,4 kg / 5,3 lb
Weight may vary due to the mouth-blown glass.

MATERIALS

Solid brass, glass.

COLOURS

Smoke / Brushed brass

PACKAGING TYPE

Gift box

PACKAGING MEASUREMENTS (H x W x D)

Small
25,8 cm x 18,9 cm x 18,6 cm / 10,2" x 7,4" x 7,4"

Large
30,5 cm x 36,5 cm x 36,5 cm / 12" x 14,4" x 14,4"

MATERIALS & MAINTENANCE

Please see page 486 for materials and care and maintenance instructions.

ÉCHASSE BOWL SMALL

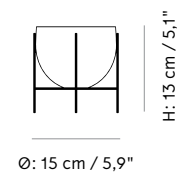

ÉCHASSE BOWL LARGE

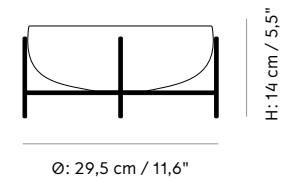

Échasse Hurricane

BY THERESA RAND

Mouth-blown opal or smoke glass bowl set on bronzed or brushed brass base.

Échasse Hurricane, Opal Glass / Bronzed Brass, by Theresa Rand
 Échasse Hurricane, Smoke Glass / Brushed Brass, by Theresa Rand
 Plinth Cubic, Nero Marquina Marble, by Norm Architects
 Plinth Tall, Carrara Marble, by Norm Architects



PRODUCT OPTIONS



Opal / Bronzed Brass
4794629



Smoke / Brushed Brass
4794949

Échasse Hurricane

BY THERESA RAND

STOCK OPTIONS — PRICES IN EUR *Selected combinations up to 2 weeks delivery time.*

SKU	VARIANT	INCL. VAT	EXCL. VAT
4794629	ÉCHASSE HURRICANE, OPAL GLASS / BRONZED BRASS	79,95	66,90
4794949	ÉCHASSE HURRICANE, SMOKE GLASS / BRUSHED BRASS	79,95	66,90

TECHNICAL SPECIFICATIONS

PRODUCT TYPE
Hurricane

PRODUCTION PROCESS
The base is made from solid brass rods with silver soldering. The surface is lightly brushed or bronzed. Glass is coloured or clear and mouth-blown.

DIMENSIONS
H: 8,5 cm / 3,5"
Ø: 14 cm / 5,5"

WEIGHT
0,3 kg / 0,66 lb
Weight may vary due to the mouth-blown glass.

MATERIALS
Solid brass, glass.

COLOURS
Smoke / Brushed brass
Opal / Bronzed brass

PACKAGING TYPE
Gift box

PACKAGING MEASUREMENTS (H x W x D)
17,5 cm x 19 cm x 19 cm / 6,9" x 7,5" x 7,5"

MATERIALS & MAINTENANCE
Please see page 486 for materials and care and maintenance instructions.

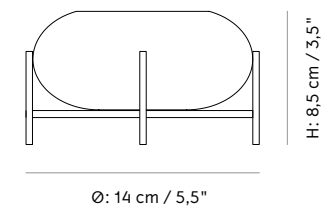

Ø: 14 cm / 5,5"

H: 8,5 cm / 3,5"

Aer Vase

BY GABRIEL TAN

Rippled, mouth-blown glass in two sizes with internal dividers for multi-bunch floral arrangements.

Plinth Tall, Calacatta Viola Marble, by Norm Architects
Aer Vase, 49, Smoke Glass, by Gabriel Tan



PRODUCT OPTIONS

VASE 33



Smoke
4736949

VASE 49



Smoke
4737949

Aer Vase

BY GABRIEL TAN

STOCK OPTIONS — PRICES IN EUR *Selected combinations up to 2 weeks delivery time.*

SKU	VARIANT	INCL. VAT	EXCL. VAT
4736949	AER VASE, 33, SMOKE GLASS	199,95	167,32
4737949	AER VASE, 49, SMOKE GLASS	299,95	251,00

TECHNICAL SPECIFICATIONS

PRODUCT TYPE

Vase

PRODUCTION PROCESS

Each vase is made from mouth-blown full colour glass.

DIMENSIONS

33
H: 33 cm / 12,9"
W: 27 cm / 10,6"
D: 13 cm / 5,1"

49
H: 49 cm / 19,2"
W: 22 cm / 8,6"
D: 10,5 cm / 4,1"

WEIGHT

33: 4,9 kg / 10,8 lb
49: 4,2 kg / 9,3 lb
Weight may vary due to the mouth-blown glass.

MATERIALS

Glass

COLOURS

Smoke

PACKAGING TYPE

Gift box

PACKAGING MEASUREMENTS (H x W x D)

33
40 cm x 35,5 cm x 21,5 cm / 15,7" x 14" x 8,5"

49
55,5 cm x 30 cm x 19 cm / 21,9" x 11,8" x 7,5"

MATERIALS & MAINTENANCE

Please see page 486 for materials and care and maintenance instructions.

AER VASE, 33

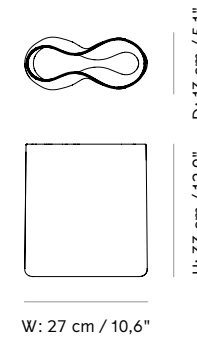

AER VASE, 49

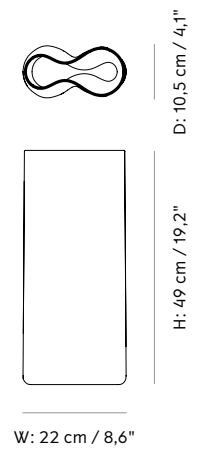

Cyclades Vase

BY NICK ROSS

Raw or glazed ceramic vessels with a curved lip. Available in two sizes and colours.

PRODUCT OPTIONS

SMALL



Black
4832539



Sand
4832039

LARGE



Black
4831539



Sand
4831039

Cyclades Vase, Large, Sand, by Nick Ross



Cyclades Vase

BY NICK ROSS

STOCK OPTIONS — PRICES IN EUR *Selected combinations up to 2 weeks delivery time.*

SKU	VARIANT	INCL. VAT	EXCL. VAT
4832539	CYCLADES VASE, S, BLACK	39,95	33,43
4832039	CYCLADES VASE, S, SAND	39,95	33,43
4831539	CYCLADES VASE, L, BLACK	79,95	66,90
4831039	CYCLADES VASE, L, SAND	79,95	66,90

TECHNICAL SPECIFICATIONS

PRODUCT TYPE

Vase

PRODUCTION PROCESS

Ceramic is shaped by rolling.

DIMENSIONS

Small
H: 20 cm / 7,9"
Ø: 11 cm / 4,3"

Large
H: 26 cm / 10,2"
Ø: 14 cm / 5,5"

WEIGHT

Small: 0,6 kg / 1,32 lb
Large: 0,7 kg / 1,54 lb

MATERIALS

Black - glazed ceramic
Sand - unglazed ceramic

COLOURS

Black
Sand

PACKAGING TYPE

Gift box

PACKAGING MEASUREMENTS (H x W x D)

Small
21 cm x 13,5 cm x 13,5 cm / 8,3" x 5,3" x 5,3"

Large
31 cm x 17 cm x 17 cm / 12,2" x 6,7" x 6,7"

MATERIALS & MAINTENANCE

Please see page 486 for materials and care and maintenance instructions.

CYCLADES VASE, SMALL

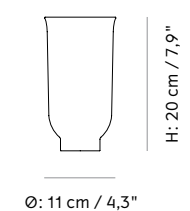

CYCLADES VASE, LARGE

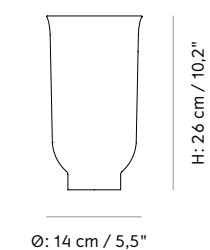

Willmann Vase

BY HANNE WILLMANN

Mouth-blown glass vase with grey concrete TOP.

PRODUCT OPTIONS



Light Grey
4736039

Plinth Tall, Calacatta Viola Marble, by Norm Architects
Willmann Vase, by Hanne Willmann



Willmann Vase

BY HANNE WILLMANN

STOCK OPTIONS — PRICES IN EUR *Selected combinations up to 2 weeks delivery time.*

SKU	VARIANT	INCL. VAT	EXCL. VAT
4736039	WILLMANN VASE, LIGHT GREY	79,95	66,90

TECHNICAL SPECIFICATIONS

PRODUCT TYPE
Vase

WEIGHT
1 kg / 2,20 lb

PACKAGING TYPE
Gift box

PRODUCTION PROCESS
The glass is made from borosilicate glass. The top is made of moulded concrete.

MATERIALS
Glass and concrete.

PACKAGING MEASUREMENTS (H x W x D)
24 cm x 14,7 cm x 14,5 cm / 9,4" x 5,8" x 5,7"

DIMENSIONS
Ø: 12 cm / 4,7"
H: 20 cm / 7,9"

COLOURS
Light grey

MATERIALS & MAINTENANCE
Please see page 486 for materials and care and maintenance instructions.

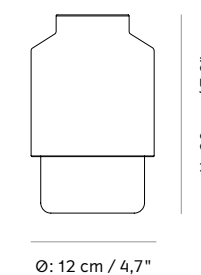

Ø: 12 cm / 4,7"

H: 20 cm / 7,9"

Troll Vase

BY ANDERSSSEN & VOLL

Mouth-blown amber or smoke glass vase with solid base and transparent upper. Available in three sizes.

Plinth Tall, Grey Kendzo Marble, by Norm Architects
 Troll Vase, Medium, Amber, by Anderssen & Voll
 Troll Vase, Large, Amber, by Anderssen & Voll
 Troll Vase, X-Large, Amber, by Anderssen & Voll



PRODUCT OPTIONS

MEDIUM



Amber
4732929



Smoke
4732949

LARGE



Amber
4733929



Smoke
4733949

X-LARGE



Amber
4734929



Smoke
4734949

Troll Vase

BY ANDERSSSEN & VOLL

STOCK OPTIONS — PRICES IN EUR *Selected combinations up to 2 weeks delivery time.*

SKU	VARIANT	INCL. VAT	EXCL. VAT
4732929	TROLL VASE, M, AMBER	59,95	50,17
4732949	TROLL VASE, M, SMOKE	59,95	50,17
4733929	TROLL VASE, L, AMBER	69,95	58,53
4733949	TROLL VASE, L, SMOKE	69,95	58,53
4734929	TROLL VASE, XL, AMBER	199,95	167,32
4734949	TROLL VASE, XL, SMOKE	199,95	167,32

TECHNICAL SPECIFICATIONS

PRODUCT TYPE
Vase

PRODUCTION PROCESS
Each vase is made from a double layer of coloured, mouth-blown glass.

DIMENSIONS

Medium
Ø: 14 cm / 5,5"
H: 12 cm / 4,7"

Large
Ø: 13 cm / 5,1"
H: 19 cm / 7,5"

X-Large
Ø: 22 cm / 8,7"
H: 32 cm / 12,6"

WEIGHT
Medium: 0,8 kg / 1,76 lb
Large: 1,1 kg / 2,43 lb
X-Large: 2,6 kg / 5,73 lb
Weight may vary due to the mouth-blown glass.

MATERIALS
Glass

COLOURS
Amber
Smoke

PACKAGING TYPE
Gift box

PACKAGING MEASUREMENTS (H x W x D)

Medium
13,5 cm x 16 cm x 16 cm / 5,3" x 6,3" x 6,3"

Large
20,5 cm x 14,5 cm x 14,5 cm / 8,1" x 5,7" x 5,7"

X-Large
33 cm x 25 cm x 25 cm / 13" x 9,8" x 9,8"

MATERIALS & MAINTENANCE
Please see page 486 for materials and care and maintenance instructions.

TROLL VASE, MEDIUM

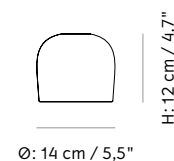

TROLL VASE, LARGE



TROLL VASE, X-LARGE

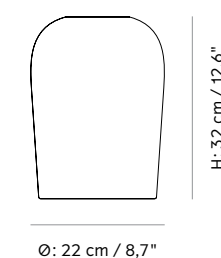

Bottle Grinders

BY NORM ARCHITECTS

Brushed brass, bronzed brass or plastic exterior with ceramic mill and walnut, beech or steel lid, depending on colour and finish selected.

Bottle Grinders, Bronzed Brass, by Norm Architects
New Norm Dinnerware, Dark Glazed, by Norm Architects
Cyclades Vase, Large, Sand, by Nick Ross



PRODUCT OPTIONS

BEECH LID



Ash / Carbon
4415399

Blues
4415299

WALNUT LID



Hunting Green / Beige
4415459

Ash / Carbon
4415369

Nudes
4415769



Brushed Brass
4415839

Bronzed Brass
4415859

STEEL LID



Ash / Carbon
4415599

Bottle Grinders

BY NORM ARCHITECTS

STOCK OPTIONS — PRICES IN EUR *Selected combinations up to 2 weeks delivery time.*

SKU	VARIANT	INCL. VAT	EXCL. VAT
4415399	BOTTLE GRINDER, BEECH LID, ASH / CARBON, 2-PACK	69,95	58,53
4415299	BOTTLE GRINDER, BEECH LID, BLUES, 2-PACK	69,95	58,53
4415459	BOTTLE GRINDER, WALNUT LID, HUNTING GREEN / BEIGE, 2-PACK	69,95	58,53
4415369	BOTTLE GRINDER, WALNUT LID, ASH / CARBON, 2-PACK	69,95	58,53
4415769	BOTTLE GRINDER, WALNUT LID, NUDES, 2-PACK	69,95	58,53
4415839	BOTTLE GRINDER, WALNUT LID, BRUSHED BRASS, 2-PACK	119,95	100,37
4415859	BOTTLE GRINDER, WALNUT LID, BRONZED BRASS, 2-PACK	119,95	100,37
4415599	BOTTLE GRINDER, STEEL LID, ASH / CARBON, 2-PACK	69,95	58,53

TECHNICAL SPECIFICATIONS

PRODUCT TYPE
Salt / Pepper grinder

MATERIALS
Stainless steel, plastic, silicone, ceramic grinder and beech or walnut.

PACKAGING TYPE
Gift box

PRODUCTION PROCESS
The body is made from plastic with a soft silicone coating or PVD-coated surface. The mill is made of ceramic and the adjustment lid is made of beech, walnut or stainless steel.

COLOURS

Beech Lid
Ash / Carbon (Pantone cool gray 1U / Black 3U)
Classic blue (Pantone 537 / 533)
Blues (Pantone 5445 / 5415)
Dark green (Pantone 627 / 5477)

PACKAGING MEASUREMENTS (H x W x D)
21,5 cm x 8,5 cm x 16,5 cm / 8,5" x 3,35" x 6,5"

MATERIALS & MAINTENANCE
Please see page 486 for materials and care and maintenance instructions.

DIMENSIONS
H: 20,5 cm / 8,1"
Ø: 8 cm / 3,1"

Walnut Lid
Hunting green / Beige (Pantone 448 / 408)
Ash / Carbon (Pantone cool grey 1U / Black 3U)
Nudes (Pantone 7591U / 7611U)
Moss greens (Pantone 5577M / 5595M)
Brushed brass
Bronzed brass

Stainless Steel Lid
Ash / Carbon (Pantone cool grey 1U / Black 3U)

WEIGHT
0,6 kg / 1,32 lb

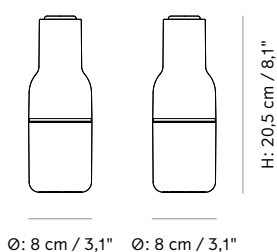

Bottle Collection

BY NORM ARCHITECTS

Mouth-blown smoke or clear glass bottle with solid brass or stainless steel lid trimmed with silicone. Available in two sizes.

PRODUCT OPTIONS

WATER BOTTLE 0,5 L



Smoke / Brass
4681949

Clear / Brass
4681839

BOTTLE CARAFE 1 L



Smoke / Brass
4682949

Clear / Brass
4680839

Clear / Steel
4680039

Bottle Carafe, 1 L, Smoke / Brass, by Norm Architects



Bottle Collection

BY NORM ARCHITECTS

STOCK OPTIONS — PRICES IN EUR *Selected combinations up to 2 weeks delivery time.*

SKU	VARIANT	INCL. VAT	EXCL. VAT
4681949	WATER BOTTLE, 0,5 L, SMOKE / BRASS	39,95	33,43
4681839	WATER BOTTLE, 0,5 L, CLEAR / BRASS	39,95	33,43
4682949	BOTTLE CARAFE, 1 L, SMOKE / BRASS	49,95	41,80
4680839	BOTTLE CARAFE, 1 L, CLEAR / BRASS	49,95	41,80
4680039	BOTTLE CARAFE, 1 L, CLEAR / STEEL	39,95	33,43

TECHNICAL SPECIFICATIONS

PRODUCT TYPE

Water bottle / Bottle carafe

PRODUCTION PROCESS

The body is made from mouth-blown clear or coloured glass. The lid is made from solar polished solid brass or steel and will therefore darken and patinate over time.

DIMENSIONS

0,5 L
Ø: 8 cm / 3,1"
H: 17,9 cm / 7"

1 L
Ø: 8 cm / 3,1"
H: 29 cm / 11,4"

WEIGHT

0,5 L: 0,268 kg / 0,59 lb
1 L: 0,292 kg / 0,64 lb

MATERIALS

0,5 L: glass, brass
1 L: glass, brass, steel

COLOURS

Smoke / Brass
Clear / Brass
Clear / Steel

PACKAGING TYPE

Gift box

PACKAGING MEASUREMENTS (H x W x D)

0,5 L
22 cm x 8,5 cm x 8,5 cm / 8,7" x 3,3" x 3,3"

1 L
33 cm x 10 cm x 10 cm / 13" x 3,9" x 3,9"

MATERIALS & MAINTENANCE

Please see page 486 for materials and care and maintenance instructions.

WATER BOTTLE 0,5 L

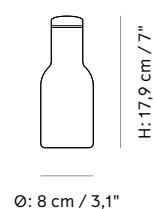

BOTTLE CARAFE 1 L

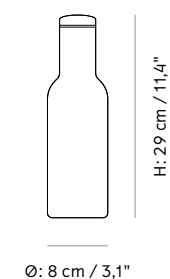

Wine Breather Collection

BY NORM ARCHITECTS

Mouth-blown smoke or clear glass decanter with brass-plated steel or stainless steel lid with silicone trim.

PRODUCT OPTIONS

WINE BREATHER



Smoke / Brass
4680949



Clear / Steel
4680069

WINE BREATHER DELUXE



Clear / Steel
4683039



Clear / Brass
4683829

Wine Breather Deluxe, Clear / Steel, by Norm Architects



Wine Breather Collection

BY NORM ARCHITECTS

STOCK OPTIONS — PRICES IN EUR *Selected combinations up to 2 weeks delivery time.*

SKU	VARIANT	INCL. VAT	EXCL. VAT
4680949	WINE BREATHER, SMOKE / BRASS	79,95	66,90
4680069	WINE BREATHER, CLEAR / STEEL	69,95	58,53
4683039	WINE BREATHER DELUXE, CLEAR / STEEL	79,95	66,90
4683829	WINE BREATHER DELUXE, CLEAR / BRASS	79,95	66,90

TECHNICAL SPECIFICATIONS

PRODUCT TYPE
Wine breather

PRODUCTION PROCESS
The bottle is made from smoke or clear mouth-blown glass. The lid is made from deep-drawn stainless steel with PVD plating. The lid is made from solar polished solid brass or steel and will therefore darken and patinate over time.

DIMENSIONS

Wine Breather
H: 22 cm / 8,7"
Ø: 16,5 cm / 6,5"

Wine Breather Deluxe
H: 21 cm / 8,3"
Ø: 20 cm / 7,9"

WEIGHT
Wine Breather: 0,5 kg / 1,10 lb
Wine Breather Deluxe: 0,75 kg / 1,65 lb

MATERIALS
Glass, PVD-plated steel or stainless steel, silicone, plastic.

COLOURS

Wine Breather
Smoke / Brass
Clear / Steel

Wine Breather Deluxe
Clear / Steel
Clear / Brass

PACKAGING TYPE
Gift box

PACKAGING MEASUREMENTS (H x W x D)

Wine Breather
19,1 cm x 21,6 cm x 21,6 cm / 7,5" x 7,2" x 7,2"

Wine Breather Deluxe
22 cm x 21,8 cm x 21,8 cm / 8,7" x 8,6" x 8,6"

MATERIALS & MAINTENANCE
Please see page 486 for materials and care and maintenance instructions.

WINE BREATHER

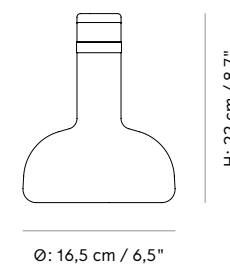

WINE BREATHER DELUXE

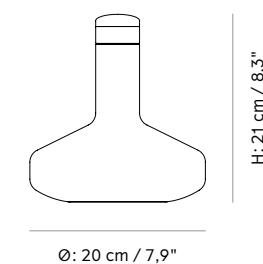

Stackable Glass

BY NORM ARCHITECTS

Non-lead, dishwasher-safe silica drinking glass.
Available in three sizes.

Stackable Glass, by Norm Architects



PRODUCT OPTIONS

18 CL



18 cl
3000019

27 CL



27 cl
3000039

33 CL



33 cl
3000059

Stackable Glass

BY NORM ARCHITECTS

STOCK OPTIONS — PRICES IN EUR *Selected combinations up to 2 weeks delivery time.*

SKU	VARIANT	INCL. VAT	EXCL. VAT
3000019	STACKABLE GLASS, 18 CL	13,95	11,67
3000039	STACKABLE GLASS, 27 CL	15,95	13,35
3000059	STACKABLE GLASS, 33 CL	16,95	14,18

TECHNICAL SPECIFICATIONS

PRODUCT TYPE

Glass

PRODUCTION PROCESS

Each glass is mouth-blown from silica glass.

DIMENSIONS

18 cl
Ø: 8 cm / 3,1"
H: 7 cm / 2,8"

27 cl
Ø: 8 cm / 3,1"
H: 9,5 cm / 3,7"

33 cl
Ø: 8 cm / 3,1"
H: 12 cm / 4,7"

WEIGHT

18 cl: 0,12 kg / 0,26 lb
27 cl: 0,14 kg / 0,31 lb
33 cl: 0,16 kg / 0,35 lb

MATERIALS

Glass

COLOURS

Clear

PACKAGING TYPE

Gift box

PACKAGING MEASUREMENTS (H x W x D)

18 cl
8,2 cm x 8,7 cm x 8,7 cm / 3,2" x 3,4" x 3,4"

27 cl
10,7 cm x 8,7 cm x 8,7 cm / 4,2" x 3,4" x 3,4"

33 cl
12,7 cm x 8,7 cm x 8,7 cm / 5,0" x 3,4" x 3,4"

MATERIALS & MAINTENANCE

Please see page 486 for materials and care and maintenance instructions.

STACKABLE GLASS, 18 CL

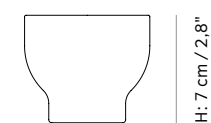

Ø: 8 cm / 3,1"

H: 7 cm / 2,8"

STACKABLE GLASS, 27 CL

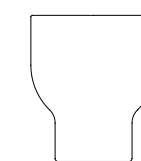

Ø: 8 cm / 3,1"

H: 9,5 cm / 3,7"

STACKABLE GLASS, 33 CL

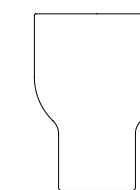

Ø: 8 cm / 3,1"

H: 12 cm / 4,7"

Kettle Teapot

BY NORM ARCHITECTS

Heat resistant glass teapot with stainless steel tea egg and silicone string and stopper.

Kettle Teapot, 0,75 L, by Norm Architects
 Cast Tea Heater, by Norm Architects
 New Norm Dinnerware, Dark Glazed, by Norm Architects
 Androgynous Dining Table, Ø120, Natural Oak, by Danielle Siggerud
 Co Chair, Black Steel / Natural Oak, by Norm Architects & Els Van Hoorebeeck



PRODUCT OPTIONS

0,75 L



0,75 L
4545119

1,5 L



1,5 L
4545129

Kettle Teapot

BY NORM ARCHITECTS

STOCK OPTIONS — PRICES IN EUR *Selected combinations up to 2 weeks delivery time.*

SKU	VARIANT	INCL. VAT	EXCL. VAT
4545119	KETTLE TEAPOT, 0,75 L	59,95	50,17
4545129	KETTLE TEAPOT, 1,5 L	69,95	58,53

TECHNICAL SPECIFICATIONS

PRODUCT TYPE
Teapot

PRODUCTION PROCESS
The kettle is made from mouth-blown borosilicate glass. The tea egg is made from pressed steel and silicone.

DIMENSIONS

0,75 L
Ø: 13 cm / 5,1"
H: 14 cm / 5,5"

1,5 L
Ø: 13 cm / 5,1"
H: 19 cm / 7,9"

WEIGHT
0,75 L: 0,37 kg / 0,74 lb
1,5 L: 0,44 kg / 0,97 lb

MATERIALS
Glass, stainless steel, plastic, silicone.

COLOURS
Clear

PACKAGING TYPE
Gift box

PACKAGING MEASUREMENTS (H x W x D)

0,75 L
16,3 cm x 17 cm x 17 cm / 6,4" x 6,7" x 6,7"

1,5 L
21,3 cm x 17 cm / 8,4" x 6,7" x 6,7"

MATERIALS & MAINTENANCE
Please see page 486 for materials and care and maintenance instructions.

KETTLE TEAPOT, 0,75 L

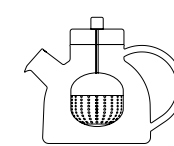
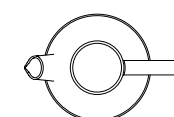

Ø: 13 cm / 5,1"

H: 14 cm / 5,5"

KETTLE TEAPOT, 1,5 L

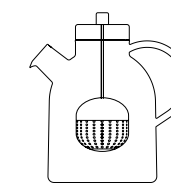
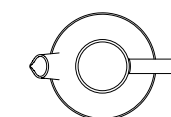

Ø: 13 cm / 5,1"

H: 19 cm / 7,9"

Heater for Kettle Teapot

BY NORM ARCHITECTS

PRODUCT OPTIONS

Glazed white porcelain teapot heater with tealight candleholder and silicone grips on the base.



White
4518639

STOCK OPTIONS — PRICES IN EUR *Selected combinations up to 2 weeks delivery time.*

SKU	VARIANT	INCL. VAT	EXCL. VAT
4518639	HEATER FOR KETTLE TEAPOT	39,95	33,43

TECHNICAL SPECIFICATIONS

PRODUCT TYPE Teapot heater	WEIGHT 0,6 kg / 1,32 lb	PACKAGING TYPE Gift box
PRODUCTION PROCESS Porcelain slip casting.	MATERIALS Porcelain, silicone.	PACKAGING MEASUREMENTS (H x W x D) 10,5 cm x 16 cm x 16 cm / 4,1" x 6,3" x 6,3"
DIMENSIONS H: 10 cm / 3,9" Ø: 13,2 cm / 5,2"	COLOURS White	MATERIALS & MAINTENANCE Please see page 486 for materials and care and maintenance instructions.

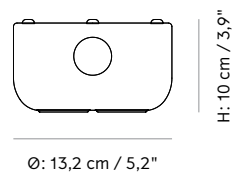

Cast Tea Heater

BY NORM ARCHITECTS

PRODUCT OPTIONS

Black powder coated steel trivet with textured surface and tealight holder.



Black
4545539

STOCK OPTIONS — PRICES IN EUR *Selected combinations up to 2 weeks delivery time.*

SKU	VARIANT	INCL. VAT	EXCL. VAT
4545539	CAST TEA HEATER, BLACK	49,95	41,80

TECHNICAL SPECIFICATIONS

PRODUCT TYPE Teapot heater	WEIGHT 0,4 kg / 0,88 lb	PACKAGING TYPE Gift box
PRODUCTION PROCESS Welded, cut steel sheet and cast tealight cup.	MATERIALS Powder coated steel, rubber.	PACKAGING MEASUREMENTS (H x W x D) 9 cm x 13 cm x 13 cm / 3,5" x 5,1" x 5,1"
DIMENSIONS H: 7,6 cm / 3" Ø: 14,6 cm / 5,7"	COLOURS Black (9005)	MATERIALS & MAINTENANCE Please see page 486 for materials and care and maintenance instructions.

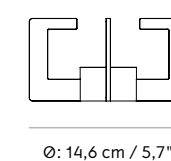
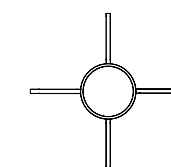

New Norm Dinnerware Bowl

BY NORM ARCHITECTS

Rolled or slip cast double-fired porcelain bowls with hand-applied glaze in white, ocean and smoke colours and reactive glaze on dark variant.

Snaregade Dining Table, Ø138, Light Grey Steel/Mushroom Linoleum, by Norm Architects
 Bottle Carafe, 1 L, Smoke Glass / Brass, by Norm Architects
 Stackable Glass, by Norm Architects
 New Norm Dinnerware, Dark Glazed, by Norm Architects
 New Norm Cutlery, by Norm Architects



PRODUCT OPTIONS

BOWL Ø7,5



Dark Glazed
2033530



Ocean
2033710



Smoke
2033940



White
2033630

BOWL Ø10



Dark Glazed
2032530



Ocean
2032710



Smoke
2032940



White
2032630

BOWL Ø13,5



Dark Glazed
2016530



Ocean
2016710



Smoke
2016940



White
2016630

New Norm Dinnerware Bowl

BY NORM ARCHITECTS

STOCK OPTIONS — PRICES IN EUR *Selected combinations up to 2 weeks delivery time.*

SKU	VARIANT	INCL. VAT	EXCL. VAT
2033530	NEW NORM DINNERWARE BOWL, Ø7,5 CM, DARK GLAZED	13,95	11,67
2033710	NEW NORM DINNERWARE BOWL, Ø7,5 CM, OCEAN	13,95	11,67
2033940	NEW NORM DINNERWARE BOWL, Ø7,5 CM, SMOKE	13,95	11,67
2033630	NEW NORM DINNERWARE BOWL, Ø7,5 CM, WHITE	13,95	11,67
2032530	NEW NORM DINNERWARE BOWL, Ø10 CM, DARK GLAZED	16,95	14,18
2032710	NEW NORM DINNERWARE BOWL, Ø10 CM, OCEAN	16,95	14,18
2032940	NEW NORM DINNERWARE BOWL, Ø10 CM, SMOKE	16,95	14,18
2032630	NEW NORM DINNERWARE BOWL, Ø10 CM, WHITE	16,95	14,18
2016530	NEW NORM DINNERWARE BOWL, Ø13,5 CM, DARK GLAZED	21,95	18,37
2016710	NEW NORM DINNERWARE BOWL, Ø13,5 CM, OCEAN	21,95	18,37
2016940	NEW NORM DINNERWARE BOWL, Ø13,5 CM, SMOKE	21,95	18,37
2016630	NEW NORM DINNERWARE BOWL, Ø13,5 CM, WHITE	21,95	18,37

TECHNICAL SPECIFICATIONS

PRODUCT TYPE
Bowl

PRODUCTION PROCESS
Stoneware and porcelain shaped by rolling. White is by air reduction firing and the coloured is by oxidation firing (fired at 1260 - 1300 degree celsius, cone 8 - 10).

WEIGHT
Ø7,5: 0,089 kg / 0,2 lb
Ø10: 0,177 kg / 0,4 lb
Ø13,5: 0,323 kg / 0,7lb

MATERIALS
Clay, glaze.

DIMENSIONS

Ø7,5
Ø: 7,5 cm / 3"
H: 4,3 cm / 1,7"

Ø10
Ø: 10 cm / 3,9"
H: 5,3 cm / 2,1"

Ø13,5
Ø: 13,5 cm / 5,3"
H: 5,8 cm / 2,3"

COLOURS

Dark glazed
Ocean
Smoke
White

PACKAGING TYPE
Brown box, bulk packaged.

PACKAGING MEASUREMENTS (H x W x D)

Ø7,5
4,5 cm x 8 cm x 8 cm / 1,8" x 3,1" x 3,1"

Ø10
5,5 cm x 11,5 cm x 11,5 cm / 2,2" x 4,5" x 4,5"

Ø13,5
6 cm x 14 cm x 14 cm / 2,4" x 5,5" x 5,5"

MATERIALS & MAINTENANCE
Please see page 486 for materials and care and maintenance instructions.

BOWL Ø7,5



Ø: 7,5 cm / 3"

BOWL Ø10



Ø: 10 cm / 3,9"

BOWL Ø13,5

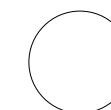

Ø: 13,5 cm / 5,3"

New Norm Dinnerware Bowl

BY NORM ARCHITECTS

Rolled or slip cast double-fired porcelain bowls with hand-applied glaze in white, ocean and smoke colours and reactive glaze on dark variant.

New Norm Dinnerware, Dark Glazed, by Norm Architects



PRODUCT OPTIONS

BOWL Ø17,5



Dark Glazed
2017530



Ocean
2017710



Smoke
2017940



White
2017630

BOWL Ø21,5



Dark Glazed
2018530



Smoke
2018940



White
2018630

BOWL Ø25



Dark Glazed
2019530



White
2019630

New Norm Dinnerware Bowl

BY NORM ARCHITECTS

STOCK OPTIONS — PRICES IN EUR

Selected combinations up to 2 weeks delivery time.

SKU	VARIANT	INCL. VAT	EXCL. VAT
2017530	NEW NORM DINNERWARE BOWL, Ø17,5 CM, DARK GLAZED	26,95	22,55
2017710	NEW NORM DINNERWARE BOWL, Ø17,5 CM, OCEAN	26,95	22,55
2017940	NEW NORM DINNERWARE BOWL, Ø17,5 CM, SMOKE	26,95	22,55
2017630	NEW NORM DINNERWARE BOWL, Ø17,5 CM, WHITE	26,95	22,55
2018530	NEW NORM DINNERWARE BOWL, Ø21,5 CM, DARK GLAZED	39,95	33,43
2018940	NEW NORM DINNERWARE BOWL, Ø21,5 CM, SMOKE	39,95	33,43
2018630	NEW NORM DINNERWARE BOWL, Ø21,5 CM, WHITE	39,95	33,43
2019530	NEW NORM DINNERWARE BOWL, Ø25 CM, DARK GLAZED	49,95	41,80
2019630	NEW NORM DINNERWARE BOWL, Ø25 CM, WHITE	49,95	41,80

TECHNICAL SPECIFICATIONS

PRODUCT TYPE

Bowl

DIMENSIONS

Ø17,5
Ø: 17,5 cm / 6,9"
H: 6,3 cm / 2,5"

Ø21,5
Ø: 21,5 cm / 8,5"
H: 6,8 cm / 2,7"

Ø25
Ø: 25 cm / 9,8"
H: 7,8 cm / 3,1"

COLOURS

Dark glazed
Ocean
Smoke
White

PACKAGING TYPE

Brown box, bulk packaged.

PACKAGING MEASUREMENTS (H x W x D)

Ø17,5
6,5 cm x 18 cm x 18 cm / 2,6" x 7,1" x 7,1"

Ø21,5
7 cm x 22 cm x 22 cm / 2,8" x 8,7" x 8,7"

Ø25
8 cm x 25,5 cm x 25,5 cm / 3,1" x 10,0" x 10,0"

MATERIALS & MAINTENANCE

Please see page 486 for materials and care and maintenance instructions.

BOWL Ø17,5

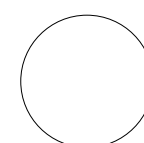

Ø: 17,5 cm / 6,9"

BOWL Ø21,5

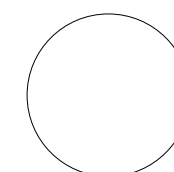

Ø: 21,5 cm / 8,5"

BOWL Ø25

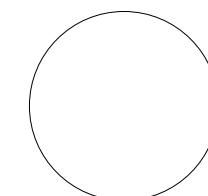

Ø: 25 cm / 9,8"

New Norm Dinnerware Low Bowl

BY NORM ARCHITECTS

Rolled or slip cast double-fired porcelain bowls with hand-applied glaze in white, ocean and smoke colours and reactive glaze on dark variant.

PRODUCT OPTIONS



Dark Glazed
2031530



Ocean
2031710



Smoke
2031940



White
2031630

Bottle Grinders, Walnut / Ash / Carbon, by Norm Architects
New Norm Dinnerware, Dark Glazed, by Norm Architects



New Norm Dinnerware Low Bowl

BY NORM ARCHITECTS

STOCK OPTIONS — PRICES IN EUR *Selected combinations up to 2 weeks delivery time.*

SKU	VARIANT	INCL. VAT	EXCL. VAT
2031530	NEW NORM DINNERWARE LOW BOWL, Ø13,5 CM, DARK GLAZED	18,95	15,86
2031710	NEW NORM DINNERWARE LOW BOWL, Ø13,5 CM, OCEAN	18,95	15,86
2031940	NEW NORM DINNERWARE LOW BOWL, Ø13,5 CM, SMOKE	18,95	15,86
2031630	NEW NORM DINNERWARE LOW BOWL, Ø13,5 CM, WHITE	18,95	15,86

TECHNICAL SPECIFICATIONS

PRODUCT TYPE
Bowl

WEIGHT
0,24 kg / 0,53 lb

PACKAGING TYPE
Brown box, bulk packaged.

PRODUCTION PROCESS
Stoneware and porcelain shaped by rolling. White is by air reduction firing and the coloured is by oxidation firing (fired at 1260 - 1300 degree celsius, cone 8 - 10).

MATERIALS
Clay, glaze

PACKAGING MEASUREMENTS (H x W x D)
5,5 cm x 13,5 cm x 13,5 cm / 2,2" x 5,3" x 5,3"

DIMENSIONS
Ø: 13,5 cm / 5,3"
H: 5 cm / 1,9"

COLOURS
Dark glazed
Ocean
Smoke
White

MATERIALS & MAINTENANCE
Please see page 486 for materials and care and maintenance instructions.

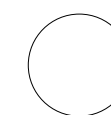

Ø: 13,5 cm / 5,3"

New Norm Dinnerware Plate

BY NORM ARCHITECTS

Rolled or slip cast double-fired porcelain plates with hand-applied glaze in white and reactive glaze on dark variant.

PRODUCT OPTIONS



Dark Glazed
2010530



White
2010630

New Norm Dinnerware Plate

BY NORM ARCHITECTS

STOCK OPTIONS — PRICES IN EUR *Selected combinations up to 2 weeks delivery time.*

SKU	VARIANT	INCL. VAT	EXCL. VAT
2010530	NEW NORM DINNER PLATE, Ø27,5 CM, DARK GLAZED	29,95	25,06
2010630	NEW NORM DINNER PLATE, Ø27,5 CM, WHITE	29,95	25,06

TECHNICAL SPECIFICATIONS

PRODUCT TYPE
Plate or dish

WEIGHT
0,72 kg / 1,59 lb

PACKAGING TYPE
Brown box, bulk packaged.

PRODUCTION PROCESS
Stoneware and porcelain shaped by rolling. White is by air reduction firing and the coloured is by oxidation firing (fired at 1260 - 1300 degree celsius, cone 8 - 10).

MATERIALS
Clay, glaze

PACKAGING MEASUREMENTS (H x W x D)
2,2 cm x 28 cm x 28 cm / 0,9" x 11" x 11"

DIMENSIONS
Ø: 27,5 cm / 11,2"
H: 2 cm / 0,8"

COLOURS
Dark glazed
White

MATERIALS & MAINTENANCE
Please see page 486 for materials and care and maintenance instructions.

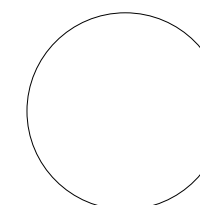

Ø: 27,5 cm / 11,2"

New Norm Dinnerware Plate/Dish

BY NORM ARCHITECTS

Rolled or slip cast double-fired porcelain plates with hand-applied glaze in white, ocean and smoke colours and reactive glaze on dark variant.

PRODUCT OPTIONS

SIDE PLATE Ø19



Dark Glazed
2020530

Ocean
2020710

Smoke
2020940

White
2020630

LUNCH PLATE Ø23



Dark Glazed
2014530

Ocean
2014710



Smoke
2014940

White
2014630

PLATE / DISH Ø27



Dark Glazed
2024530

Ocean
2024710



Smoke
2024940

White
2024630

New Norm Dinnerware Plate/Dish

BY NORM ARCHITECTS

STOCK OPTIONS — PRICES IN EUR *Selected combinations up to 2 weeks delivery time.*

SKU	VARIANT	INCL. VAT	EXCL. VAT
2020530	NEW NORM SIDE PLATE, Ø19 CM, DARK GLAZED	21,95	18,37
2020710	NEW NORM SIDE PLATE, Ø19 CM, OCEAN	21,95	18,37
2020940	NEW NORM SIDE PLATE, Ø19 CM, SMOKE	21,95	18,37
2020630	NEW NORM SIDE PLATE, Ø19 CM, WHITE	21,95	18,37
2014530	NEW NORM LUNCH PLATE, Ø23 CM, DARK GLAZED	26,95	22,55
2014710	NEW NORM LUNCH PLATE, Ø23 CM, OCEAN	26,95	22,55
2014940	NEW NORM LUNCH PLATE, Ø23 CM, SMOKE	26,95	22,55
2014630	NEW NORM LUNCH PLATE, Ø23 CM, WHITE	26,95	22,55
2024530	NEW NORM PLATE / DISH, Ø27 CM, DARK GLAZED	31,95	26,74
2024710	NEW NORM PLATE / DISH, Ø27 CM, OCEAN	31,95	26,74
2024940	NEW NORM PLATE / DISH, Ø27 CM, SMOKE	31,95	26,74
2024630	NEW NORM PLATE / DISH, Ø27 CM, WHITE	31,95	26,74

TECHNICAL SPECIFICATIONS

PRODUCT TYPE

Plate

PRODUCTION PROCESS

Stoneware and porcelain shaped by rolling. Hite is by air reduction firing and the coloured is by oxidation firing (fired at 1260 - 1300 degree celsius, cone 8 - 10).

WEIGHT

Side Plate: 0,36 kg / 0,79 lb
Lunch Plate: 0,49 kg / 1,08 lb
Plate / Dish: 0,78 kg / 1,72 lb

MATERIALS

Clay, glaze

DIMENSIONS

Side Plate
Ø: 19 cm / 7,5"
H: 1,5 cm / 0,6"

Lunch Plate
Ø: 23 cm / 9,1"
H: 1,5 cm / 0,6"

Plate / Dish
Ø: 27 cm / 10,6"
H: 1,5 cm / 0,6"

COLOURS

Dark glazed
Ocean
Smoke
White

PACKAGING TYPE

Brown box, bulk packaged.

PACKAGING MEASUREMENTS (H x W x D)

Side Plate:
1,5 cm x 19,5 cm x 19,5 cm / 0,6" x 7,7" x 7,7"

Lunch Plate
1,7 cm x 23,5 cm x 23,5 cm / 0,7" x 9,3" x 9,3"

Plate / Dish
2 cm x 27,5 cm x 27,5 cm / 0,8" x 10,8" x 10,8"

MATERIALS & MAINTENANCE

Please see page 486 for materials and care and maintenance instructions.

SIDE PLATE Ø19

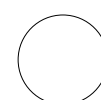

Ø: 19 cm / 7,5"

LUNCH PLATE Ø23

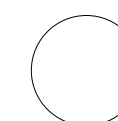

Ø: 23 cm / 9,1"

PLATE / DISH Ø27

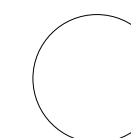

Ø: 27 cm / 10,6"

New Norm Dinnerware Plate/Lid

BY NORM ARCHITECTS

Rolled or slip cast double-fired porcelain plates with hand-applied glaze in white, ocean and smoke colours and reactive glaze on dark variant. Can be used as lid for New Norm Dinnerware Bowls.

PRODUCT OPTIONS

PLATE / LID Ø13,5



Dark Glazed
2011530

Ocean
2011710

Smoke
2011940

White
2011630

PLATE / LID Ø17,5



Dark Glazed
2012530

Ocean
2012710



Smoke
2012940

White
2012630

PLATE / LID Ø21,5



Dark Glazed
2013530

Ocean
2013710



Smoke
2013940

White
2013630

New Norm Dinnerware Plate/Lid

BY NORM ARCHITECTS

STOCK OPTIONS — PRICES IN EUR *Selected combinations up to 2 weeks delivery time.*

SKU	VARIANT	INCL. VAT	EXCL. VAT
2011530	NEW NORM PLATE / LID, Ø13,5 CM, DARK GLAZED	13,95	11,67
2011710	NEW NORM PLATE / LID, Ø13,5 CM, OCEAN	13,95	11,67
2011940	NEW NORM PLATE / LID, Ø13,5 CM, SMOKE	13,95	11,67
2011630	NEW NORM PLATE / LID, Ø13,5 CM, WHITE	13,95	11,67
2012530	NEW NORM PLATE / LID, Ø17,5 CM, DARK GLAZED	19,95	16,69
2012710	NEW NORM PLATE / LID, Ø17,5 CM, OCEAN	19,95	16,69
2012940	NEW NORM PLATE / LID, Ø17,5 CM, SMOKE	19,95	16,69
2012630	NEW NORM PLATE / LID, Ø17,5 CM, WHITE	19,95	16,69
2013530	NEW NORM PLATE / LID, Ø21,5 CM, DARK GLAZED	22,95	19,20
2013710	NEW NORM PLATE / LID, Ø21,5 CM, OCEAN	22,95	19,20
2013940	NEW NORM PLATE / LID, Ø21,5 CM, SMOKE	22,95	19,20
2013630	NEW NORM PLATE / LID, Ø21,5 CM, WHITE	22,95	19,20

TECHNICAL SPECIFICATIONS

PRODUCT TYPE
Plate / Lid

PRODUCTION PROCESS
Stoneware and porcelain shaped by rolling. hite is by air reduction firing and the coloured is by oxidation firing (fired at 1260 - 1300 degree celsius, cone 8 - 10).

WEIGHT
Ø13,5: 0,221 kg / 0,49 lb
Ø17,5: 0,429 kg / 0,95 lb
Ø21,5: 0,622 kg / 1,37 lb

MATERIALS
Clay, glaze

DIMENSIONS

Ø13,5
Ø: 13,5 cm / 5,3"
H: 0,8 cm / 0,3"

Ø17,5
Ø: 17,5 cm / 6,9"
H: 0,8 cm / 0,3"

Ø21,5
Ø: 21,5 cm / 8,5"
H: 0,8 cm / 0,3"

COLOURS

Dark glazed
Ocean
Smoke
White

PACKAGING TYPE
Brown box, bulk packaged.

PACKAGING MEASUREMENTS (H x W x D)

Ø13,5
1,2 cm x 14 cm x 14 cm / 0,5" x 5,5" x 5,5"

Ø17,5
1,2 cm x 18 cm x 18 cm / 0,5" x 7,1" x 7,1"

Ø21,5
1,2 cm x 22 cm x 22 cm / 0,5" x 8,7" x 8,7"

MATERIALS & MAINTENANCE
Please see page 486 for materials and care and maintenance instructions.

PLATE / LID Ø13,5

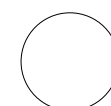

Ø: 13,5 cm / 5,3"

PLATE / LID Ø17,5

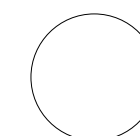

Ø: 17,5 cm / 6,9"

PLATE / LID Ø21,5

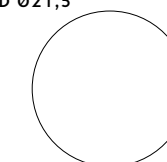

Ø: 21,5 cm / 8,5"

New Norm Thermo Cup

BY NORM ARCHITECTS

Slip cast double-fired porcelain Thermo cups with hand-applied glaze in white, ocean and smoke colours and reactive glaze on dark variant.

PRODUCT OPTIONS



Dark Glazed
4534530



Ocean
4534710



Smoke
4534940



White
4534630

New Norm Thermo Cup

BY NORM ARCHITECTS

STOCK OPTIONS — PRICES IN EUR *Selected combinations up to 2 weeks delivery time.*

SKU	VARIANT	INCL. VAT	EXCL. VAT
4534530	NEW NORM THERMO CUP, DARK GLAZED	14,95	12,51
4534710	NEW NORM THERMO CUP, OCEAN	14,95	12,51
4534940	NEW NORM THERMO CUP, SMOKE	14,95	12,51
4534630	NEW NORM THERMO CUP, WHITE	14,95	12,51

TECHNICAL SPECIFICATIONS

PRODUCT TYPE
Thermo Cup

WEIGHT
0,266 kg / 0,59 lb

PACKAGING TYPE
Brown box, bulk packaged.

PRODUCTION PROCESS
Stoneware and porcelain shaped by rolling. hite is by air reduction firing and the coloured is by oxidation firing (fired at 1260 - 1300 degree celsius, cone 8 - 10).

MATERIALS
Clay, glaze

PACKAGING MEASUREMENTS (H x W x D)
8,5 cm x 8,5 cm x 9,5cm / 3,3" x 3,3" x 3,7"

DIMENSIONS
H: 9 cm / 3,5"
Ø: 8 cm / 3,1"
V: 210 ml

COLOURS
Dark glazed
Ocean
Smoke
White

MATERIALS & MAINTENANCE
Please see page 486 for materials and care and maintenance instructions.

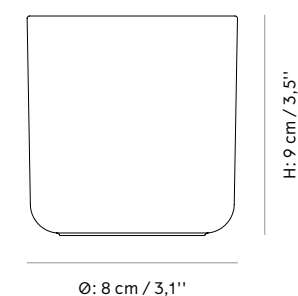

New Norm Cutlery

BY NORM ARCHITECTS

PVD-plated stainless steel flatware with rounded handles and satin finish.

New Norm Cutlery, by Norm Architects
Stackable Glass, by Norm Architects



PRODUCT OPTIONS



Brushed Steel
4995059



Brushed Steel
4995049



Brushed Steel
4995029



Brushed Steel
4995019

New Norm Cutlery

BY NORM ARCHITECTS

STOCK OPTIONS — PRICES IN EUR *Selected combinations up to 2 weeks delivery time.*

SKU	VARIANT	INCL. VAT	EXCL. VAT
4995059	NEW NORM FORK, BRUSHED STEEL	19,95	16,69
4995049	NEW NORM KNIFE, BRUSHED STEEL	19,95	16,69
4995029	NEW NORM SPOON, BRUSHED STEEL	19,95	16,69
4995019	NEW NORM TEASPOON, BRUSHED STEEL	9,95	8,33

TECHNICAL SPECIFICATIONS

PRODUCT TYPE
Cutlery

PRODUCTION PROCESS
Each piece is CNC laser cut. The knife blade is forged in stainless steel.

DIMENSIONS
Fork: L: 19 cm / 7,5"
Knife: L: 21 cm / 8,3"
Spoon: L: 19 cm / 7,5"
Teaspoon: L: 13 cm / 5,1"

WEIGHT
Fork: 0,075 kg / 0,17 lb
Knife: 0,073 kg / 0,16 lb
Spoon: 0,081 kg / 0,18 lb
Teaspoon: 0,035 kg / 0,08 lb

MATERIALS
Stainless steel

COLOURS
Brushed steel

PACKAGING TYPE
Gift box with 6 pieces, each in polybag cover.

PACKAGING MEASUREMENTS (H x W x D)

Fork:
4 cm x 21 cm x 3,5 cm / 1,6" x 8,3" x 1,4"

Knife
4 cm x 23 cm x 4 cm / 1,6" x 9,1" x 1,6"

Spoon
5 cm x 21 cm x 3,5 cm / 2" x 8,3" x 1,4"

Teaspoon
3,6 cm x 15,1 cm x 3,5 cm / 1,4" x 5,9" x 1,4"

MATERIALS & MAINTENANCE
Please see page 486 for materials and care and maintenance instructions.

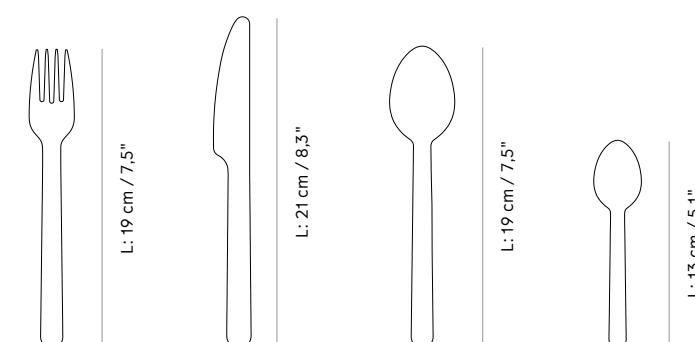

Wire Planter Base

BY NORM ARCHITECTS

Powder coated steel base and pots in white, olive and black. Available in three sizes with circular Nero Marquina or Carrara marble top.



Wire Planter Pot, Olive, by Norm Architects
Wire Planter Base, 404, Olive, by Norm Architects



PRODUCT OPTIONS

WIRE BASE 202



Black
4770539



Olive
4770429



White
4770639

WIRE BASE 404



Black
4771539



Olive
4771429



White
4771639

WIRE BASE 606



Black
4772539



Olive
4772429



White
4772639

Wire Planter Base

BY NORM ARCHITECTS

STOCK OPTIONS — PRICES IN EUR *Selected combinations up to 2 weeks delivery time.*

SKU	VARIANT	INCL. VAT	EXCL. VAT
4770539	WIRE BASE, 202, BLACK	39,95	33,43
4770429	WIRE BASE, 202, OLIVE	39,95	33,43
4770639	WIRE BASE, 202, WHITE	39,95	33,43
4771539	WIRE BASE, 404, BLACK	49,95	41,80
4771429	WIRE BASE, 404, OLIVE	49,95	41,80
4771639	WIRE BASE, 404, WHITE	49,95	41,80
4772539	WIRE BASE, 606, BLACK	59,95	50,17
4772429	WIRE BASE, 606, OLIVE	59,95	50,17
4772639	WIRE BASE, 606, WHITE	59,95	50,17

TECHNICAL SPECIFICATIONS

PRODUCT TYPE
Wire base

PRODUCTION PROCESS
The base is made from square steel rods welded together and finished with a polyester powder coating suitable for outdoor use.

WEIGHT
Wire Base 202: 0,52 kg / 1,15 lb
Wire Base 404: 0,76 kg / 1,68 lb
Wire Base 606: 1 kg / 2,20 lb

MATERIALS
Powder coated steel.

DIMENSIONS

Wire Base 202
Ø: 23 cm / 9"
H: 20 cm / 7,9"

Wire Base 404
Ø: 23 cm / 9"
H: 40 cm / 15,7"

Wire Base 606
Ø: 23 cm / 9"
H: 60 cm / 23,6"

COLOURS
Olive (NCS S 8005-G80Y)
Black (RAL 9005)
White (RAL 9016)

PACKAGING TYPE
Bulk

PACKAGING MEASUREMENTS (H x W x D)

Wire Base 202
26 cm x 26 cm x 21 cm / 10,2" x 10,2" x 8,3"

Wire Base 404
28 cm x 28 cm x 41 cm / 11,0" x 11,0" x 16,1"

Wire Base 606
30 cm x 30 cm x 61 cm / 11,8" x 11,8" x 24,0"

MATERIALS & MAINTENANCE
Please see page 486 for materials and care and maintenance instructions.

WIRE BASE 202

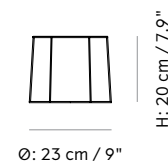

WIRE BASE 404

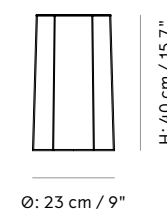

WIRE BASE 606

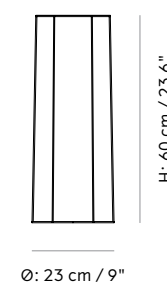

Wire Planter Table Top

BY NORM ARCHITECTS

PRODUCT OPTIONS

Circular marble table top in black and white stone variants. Compatible with Wire Planter Base.



Black
4775539

White
4775639

STOCK OPTIONS — PRICES IN EUR *Selected combinations up to 2 weeks delivery time.*

SKU	VARIANT	INCL. VAT	EXCL. VAT
4775539	WIRE TABLE TOP, MARBLE, BLACK	99,95	83,64
4775639	WIRE TABLE TOP, MARBLE, WHITE	99,95	83,64

TECHNICAL SPECIFICATIONS

PRODUCT TYPE Marble top	WEIGHT 1,75 kg / 3,86 lb	PACKAGING TYPE Brown box
PRODUCTION PROCESS The marble is milled and matte-polished.	MATERIALS Nero Marquina marble Carrara marble	PACKAGING MEASUREMENTS (H x W x D) 5 cm x 25,5 cm x 25,5 cm / 1,97" x 10" x 10"
DIMENSIONS Ø: 23 cm / 9" H: 1,8 cm / 0,71"	COLOURS Black White	MATERIALS & MAINTENANCE Please see page 486 for materials and care and maintenance instructions.

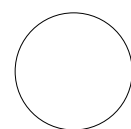

Ø: 23 cm / 9"

Wire Planter Pot

BY NORM ARCHITECTS

PRODUCT OPTIONS

Powder coated steel plant pot in three colours. For use indoors and out.



Black
4774539

Olive
4774429

White
4774639

STOCK OPTIONS — PRICES IN EUR *Selected combinations up to 2 weeks delivery time.*

SKU	VARIANT	INCL. VAT	EXCL. VAT
4774539	WIRE POT, BLACK	59,95	50,17
4774429	WIRE POT, OLIVE	59,95	50,17
4774639	WIRE POT, WHITE	59,95	50,17

TECHNICAL SPECIFICATIONS

PRODUCT TYPE Wire pot	WEIGHT 1,32 kg / 1,32 lb	PACKAGING TYPE Bulk
PRODUCTION PROCESS Pots are made from deep drawn steel, and polyester powder coating for outdoor use.	MATERIALS Powder coated steel, silicone stopper.	PACKAGING MEASUREMENTS (H x W x D) 23,5 cm x 23,5 cm 17,5 cm / 9,3" x 9,3" x 6,9"
DIMENSIONS Ø: 23 cm / 9" H: 17 cm / 6,7"	COLOURS Olive (NCS S 8005-G80Y) Black (RAL 9005) White (RAL 9016)	MATERIALS & MAINTENANCE Please see page 486 for materials and care and maintenance instructions.

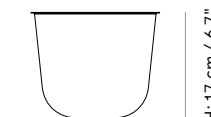

Ø: 23 cm / 9"

H: 17 cm / 6,7"

Pepe Marble Mirror

BY STUDIOPEPE

Standalone or wall-mounted glass mirrors with regular and +300% magnification on black, white or brown marble base with brushed brass frame.

Pepe Marble Mirror, Brass / Carrara Marble, by Studiopepe
 Socket Occasional Lamp, by Norm Architects
 Afterroom Stool, Black Steel / Shade Leather Sand 20298, by Afteroom



PRODUCT OPTIONS

PEPE MARBLE MIRROR



Brass / Black
3600539



Brass / Brown
3600939



Brass / White
3600639

PEPE MARBLE MIRROR WALL



Brass / Black
3610539



Brass / Brown
3610939



Brass / White
3610639

Pepe Marble Mirror

BY STUDIOPEPE

STOCK OPTIONS — PRICES IN EUR *Selected combinations up to 2 weeks delivery time.*

SKU	VARIANT	INCL. VAT	EXCL. VAT
3600539	PEPE MARBLE MIRROR, BRASS / BLACK	499,95	418,36
3600939	PEPE MARBLE MIRROR, BRASS / BROWN	499,95	418,36
3600639	PEPE MARBLE MIRROR, BRASS / WHITE	499,95	418,36
3610539	PEPE MARBLE MIRROR, WALL, BRASS / BLACK	499,95	418,36
3610939	PEPE MARBLE MIRROR, WALL, BRASS / BROWN	499,95	418,36
3610639	PEPE MARBLE MIRROR, WALL, BRASS / WHITE	499,95	418,36

TECHNICAL SPECIFICATIONS

PRODUCT TYPE

Mirror

WEIGHT

Mirror: 2,67 kg / 5,89 lb
 Mirror Wall: 2,470 kg / 5,45 lb

PACKAGING TYPE

Gift box

PRODUCTION PROCESS

The base is made from cut marble with a honed finish. The mirror part from sand casted brass.

MATERIALS

Nero Marquina marble, Carrara marble or wood grain marble, brass, glass mirror (x3).

PACKAGING MEASUREMENTS (H x W x D)

Mirror
 31,5 cm x 32 cm x 9,5 cm / 12,4" x 12,6" x 3,7"

Mirror Wall
 9,1 cm x 32,2 cm x 20,5 cm / 3,6" x 12,7" x 8,1"

DIMENSIONS

Mirror
 H: 26 cm / 10,2"
 W: 25 cm / 9,8"
 D: 3 cm / 1,2"

Mirror Wall
 H: 25 cm / 9,85"
 W: 3 cm / 1,2"
 D: 25 cm / 9,85"

COLOURS

Brass / Black
 Brass / Brown
 Brass / White

MATERIALS & MAINTENANCE

Please see page 486 for materials and care and maintenance instructions.

PEPE MARBLE MIRROR

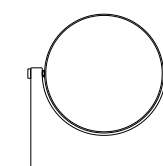

W: 25 cm / 9,8"

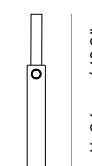

D: 3 cm / 1,2"

H: 26 cm / 10,2"

PEPE MARBLE MIRROR WALL

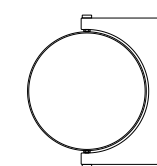

D: 25 cm / 9,85"

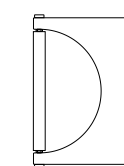

D: 16 cm

H: 25 cm / 9,85"

KaschKasch Floor Mirror

BY KASCHKASCH

Glass mirror with three-dimensional powder coated steel triangular frame.

PRODUCT OPTIONS



Black
8000539



White
8000639

KaschKasch Floor Mirror, White, by KaschKasch



KaschKasch Floor Mirror

BY KASCHKASCH

STOCK OPTIONS — PRICES IN EUR *Selected combinations up to 2 weeks delivery time.*

SKU	VARIANT	INCL. VAT	EXCL. VAT
8000539	KASCHKASCH FLOOR MIRROR, BLACK	299,95	251,00
8000639	KASCHKASCH FLOOR MIRROR, WHITE	299,95	251,00

TECHNICAL SPECIFICATIONS

PRODUCT TYPE
Floor mirror

WEIGHT
7,4 kg / 16,3 lb

PACKAGING TYPE
Gift box

PRODUCTION PROCESS
Tubular bent steel and extruded aluminium frame with cut glass mirror.

MATERIALS
Powder coated aluminium and steel, glass mirror.

PACKAGING MEASUREMENTS (H x W x D)
12 cm x 143,5 cm x 43 cm / 4,7" x 56,5" x 16,9"

DIMENSIONS
H: 175 cm / 68,9"
W: 42 cm / 16,5"
D: 20 cm / 7,9"

COLOURS
Black (RAL 9005)
White (RAL 9016)

MATERIALS & MAINTENANCE
Please see page 486 for materials and care and maintenance instructions.

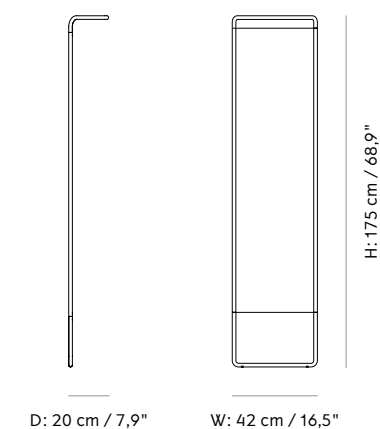

Norm Mirror

BY NORM ARCHITECTS

Mirrors with aluminium frame with either black or white powder coating. Available in three variants.

Soap Pump, Black, by Norm Architects
 Toothbrush Holder, Black, by Norm Architects
 Pedal Bin, 7 L, Black, by Norm Architects
 Cast Sconce Wall Lamp, by Tom Chung & Jordan Murphy
 Norm Mirror, Rectangular, Black, by Norm Architects



PRODUCT OPTIONS

WALL MIRROR, RECTANGULAR



Black
8020539



White
8020639

WALL MIRROR, OVAL



Black
8010539



White
8010639

FLOOR MIRROR



Black
7800589



White
7800689

Norm Mirror

BY NORM ARCHITECTS

STOCK OPTIONS — PRICES IN EUR *Selected combinations up to 2 weeks delivery time.*

SKU	VARIANT	INCL. VAT	EXCL. VAT
8020539	NORM WALL MIRROR, RECTANGULAR, BLACK	299,95	251,00
8020639	NORM WALL MIRROR, RECTANGULAR, WHITE	299,95	251,00
8010539	NORM WALL MIRROR, OVAL, BLACK	379,95	317,94
8010639	NORM WALL MIRROR, OVAL, WHITE	379,95	317,94
7800589	NORM FLOOR MIRROR, BLACK	499,95	413,16
7800689	NORM FLOOR MIRROR, WHITE	499,95	413,16

TECHNICAL SPECIFICATIONS

PRODUCT TYPE

Floor and wall mirrors.

PRODUCTION PROCESS

Extruded aluminium frame with power coated surface. Cut glass mirror.

MATERIALS

Powder coated aluminium, glass, leather (floor mirror).

WEIGHT

Rectangular Wall Mirror: 5,2 kg / 11,5 lb
 Oval Wall Mirror: 6,8 kg / 15 lb
 Floor Mirror: 12,5 kg / 27,6 lb

COLOURS

Black (RAL 9005)
 White (RAL 9016)

DIMENSIONS

Rectangular Wall Mirror

H: 50 cm / 19,7"
 W: 70 cm / 27,6"
 D: 3,5 cm / 1,4"

Oval Wall Mirror

H: 130 cm / 51,2"
 W: 40 cm / 15,7"
 D: 3,5 cm / 1,4"

Floor Mirror

H: 170 cm / 66,9"
 W: 60 cm / 23,6"
 D: 3,5 cm / 1,4"

PACKAGING TYPE

Brown box

PACKAGING MEASUREMENTS (H x W x D)

Rectangular Wall Mirror

9 cm x 58 cm x 77 cm / 3,5" x 22,8" x 30,3"

Oval Wall Mirror

8,5 cm x 137 cm x 48,5 cm / 3,3" x 54" x 19,1"

Floor Mirror

4 cm x 61 cm x 172 cm / 1,6" x 24 x 67,7"

MATERIALS & MAINTENANCE

Please see page 486 for materials and care and maintenance instructions.

RECTANGULAR WALL MIRROR

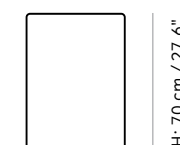

W: 50 cm / 19,7"

H: 70 cm / 27,6"

OVAL WALL MIRROR

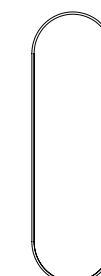

W: 40 cm / 15,7"

H: 130 cm / 51,2"

FLOOR MIRROR

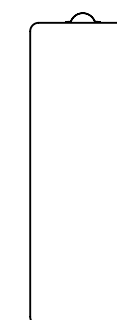

W: 60 cm / 23,6"

H: 170 cm / 66,9"

Gridy Fungi Shelf

BY GRIDY

Natural, dark stained oak or black oak shelf. Available in three sizes.

Gridy Fungi Shelf, Small, Black Oak, by Gridy
 Gridy Fungi Shelf, Medium, Dark Stained Oak, by Gridy
 Gridy Fungi Shelf, Large, Natural Oak, by Gridy



PRODUCT OPTIONS

SMALL



MEDIUM

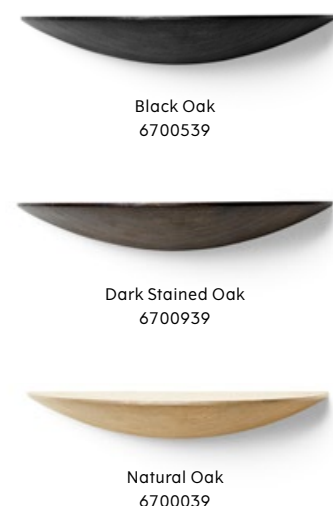

LARGE

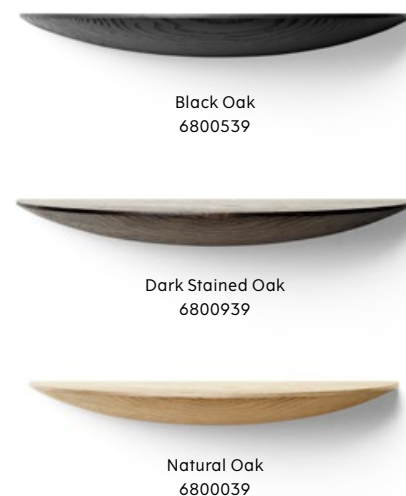

Gridy Fungi Shelf

BY GRIDY

STOCK OPTIONS — PRICES IN EUR *Selected combinations up to 2 weeks delivery time.*

SKU	VARIANT	INCL. VAT	EXCL. VAT
6600539	GRIDY FUNGI SHELF, SMALL, BLACK OAK	54,95	45,98
6600939	GRIDY FUNGI SHELF, SMALL, DARK STAINED OAK	54,95	45,98
6600039	GRIDY FUNGI SHELF, SMALL, NATURAL OAK	54,95	45,98
6700539	GRIDY FUNGI SHELF, MEDIUM, BLACK OAK	79,95	66,90
6700939	GRIDY FUNGI SHELF, MEDIUM, DARK STAINED OAK	79,95	66,90
6700039	GRIDY FUNGI SHELF, MEDIUM, NATURAL OAK	79,95	66,90
6800539	GRIDY FUNGI SHELF, LARGE, BLACK OAK	119,95	100,37
6800939	GRIDY FUNGI SHELF, LARGE, DARK STAINED OAK	119,95	100,37
6800039	GRIDY FUNGI SHELF, LARGE, NATURAL OAK	119,95	100,37

TECHNICAL SPECIFICATIONS

PRODUCT TYPE
Shelf

PRODUCTION PROCESS
Shelves are made with CNC laser cut, glued wood.

WEIGHT
Small: 0,4 kg / 0,88 lb
 Medium: 0,7 kg / 1,54 lb
 Large: 1,5 kg / 3,30 lb

MATERIALS
Oak, painted black oak and dark stained oak.

DIMENSIONS

Small
 H: 5 cm / 1,96"
 W: 22 cm / 8,7"
 D: 11 cm / 4,3"

Medium
 H: 5 cm / 1,96"
 W: 30 cm / 11,8"
 D: 15 cm / 5,9"

Large
 H: 5 cm / 1,96"
 W: 42 cm / 16,5"
 D: 21 cm / 8,3"

COLOURS
 Black oak
 Dark stained oak
 Natural oak

PACKAGING TYPE
Gift box

PACKAGING MEASUREMENTS (H x W x D)

Small
5,5 cm x 23,5 cm x 12 cm / 2,2" x 9,3" x 4,7"

Medium
5,5 cm x 32,5 cm x 16,2 cm / 2,2" x 12,8" x 6,4"

Large
5,5 cm x 44 cm x 22 cm / 2,2" x 17,3" x 8,7"

MATERIALS & MAINTENANCE
Please see page 486 for materials and care and maintenance instructions.

FUNGI SHELF SMALL

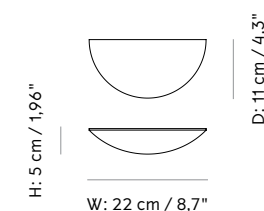

FUNGI SHELF MEDIUM

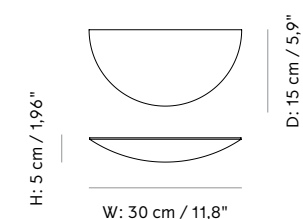

FUNGI SHELF LARGE

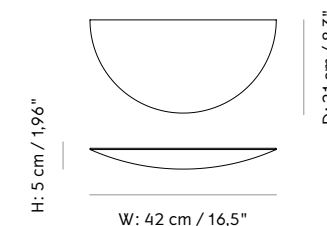

Norm Wire Bin

BY NORM ARCHITECTS

PRODUCT OPTIONS

Open weave powder coated steel basket.



Black
9000539

STOCK OPTIONS — PRICES IN EUR

Selected combinations up to 2 weeks delivery time.

SKU	VARIANT	INCL. VAT	EXCL. VAT
9000539	NORM WIRE BIN, BLACK	69,95	58,53

TECHNICAL SPECIFICATIONS

PRODUCT TYPE
Bin

WEIGHT
1 kg / 2,20 lb

PACKAGING TYPE
Bulk

PRODUCTION PROCESS
Welded steel rods with a powder coated surface.

MATERIALS
Powder coated steel.

PACKAGING MEASUREMENTS (H x W x D)
35,5 cm x 32 cm x 32 cm / 13,9" x 12,6" x 12,6"

DIMENSIONS
Ø: 32 cm / 12,6"
H: 35 cm / 13,8"

COLOURS
Black (RAL 9005)

MATERIALS & MAINTENANCE
Please see page 486 for materials and care and maintenance instructions.



Ø: 32 cm / 12,6"

H: 35 cm / 13,8"

Ava Hanger

BY THERESA RAND

PRODUCT OPTIONS

Black powder coated steel hanger with brass hook.

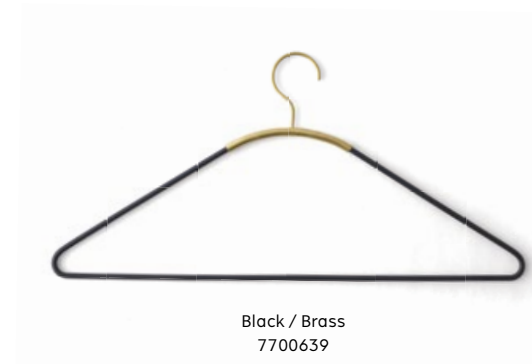

Black / Brass
7700639

STOCK OPTIONS — PRICES IN EUR

Selected combinations up to 2 weeks delivery time.

SKU	VARIANT	INCL. VAT	EXCL. VAT
9000839	AVA HANGER, BLACK / BRASS	24,95	20,88

TECHNICAL SPECIFICATIONS

PRODUCT TYPE
Hanger

WEIGHT
0,2 kg / 0,44 lb

PACKAGING TYPE
Polybag, bulk

PRODUCTION PROCESS
The hanger is made from powder coated steel and solid brass wire.

MATERIALS
Powder coated steel, brass.

PACKAGING MEASUREMENTS (H x W x D)
21 cm x 44 cm x 0,5 cm / 13,9" x 12,6" x 12,6"

DIMENSIONS
H: 21 cm / 8,3"
W: 44 cm / 17,3"
D: 0,5 cm / 0,2"

COLOURS
Brushed brass / black (RAL 9005)

MATERIALS & MAINTENANCE
Please see page 486 for materials and care and maintenance instructions.

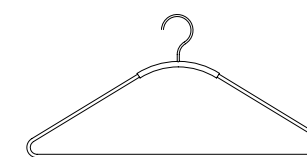

W: 44 cm / 17,3", D: 0,5 cm / 0,2"

H: 21 cm / 8,3"

Afterroom Coat Hanger

BY AFTEROOM

Powder coated steel hanger with two to six circular hooks.

PRODUCT OPTIONS

SMALL



Black
8910539

Black / Brass
8910579

LARGE



Black
8900539



Black / Brass
8900579



White
8900639

Afterroom Coat Hangers, Small, Black / Brass, by Afterroom



Afterroom Coat Hanger

BY AFTEROOM

STOCK OPTIONS — PRICES IN EUR *Selected combinations up to 2 weeks delivery time.*

SKU	VARIANT	INCL. VAT	EXCL. VAT
8910539	AFTEROOM COAT HANGER, SMALL, BLACK	49,95	41,80
8910579	AFTEROOM COAT HANGER, SMALL, BLACK / BRASS	49,95	41,80
8900539	AFTEROOM COAT HANGER, BLACK	129,95	108,74
8900579	AFTEROOM COAT HANGER, BLACK / BRASS	129,95	108,74
8900639	AFTEROOM COAT HANGER, WHITE	129,95	108,74

TECHNICAL SPECIFICATIONS

PRODUCT TYPE
Coat hanger

WEIGHT
Small: 0,3 kg / 0,66 lb
Large: 0,8 kg / 1,76 lb

PACKAGING TYPE
Gift box

PRODUCTION PROCESS
The coat hanger is made from cast zinc alloy with a powder coated or plated surface.

MATERIALS
Powder coated and plated zinc alloy.

PACKAGING MEASUREMENTS (H x W x D)

Small
21,5 cm x 10,2 cm x 4,4 cm / 8,5" x 4,0" x 1,7"

Large
20 cm x 37 cm x 4,5 cm / 7,9" x 14,6" x 1,8"

MATERIALS & MAINTENANCE
Please see page 486 for materials and care and maintenance instructions.

DIMENSIONS

Small
H: 7,4 cm / 2,9"
W: 18,5 cm / 7,3"
D: 4 cm / 1,6"

COLOURS
Black (RAL 9005)
Black (RAL 9005) / Brass
White (RAL 9016)
Black (RAL 9005) / Burgundy (Pantone 188C) / Brass

Large
H: 24 cm / 9,4"
W: 37 cm / 14,6"
D: 4 cm / 1,6"

SMALL

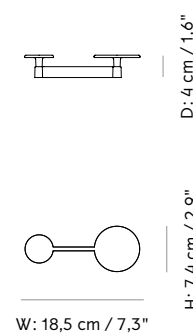

LARGE

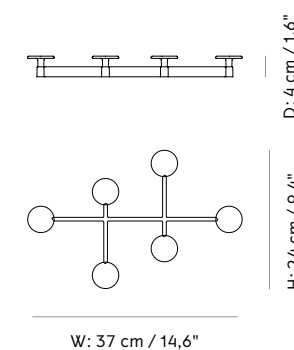

Monument Magazine Holder

BY DUBOKK

PRODUCT OPTIONS

Bronzed brass Magazine Holder set on Nero Marquina marble supports.



Black / Bronzed Brass
6410539

STOCK OPTIONS — PRICES IN EUR *Selected combinations up to 2 weeks delivery time.*

SKU	VARIANT	INCL. VAT	EXCL. VAT
6410539	MONUMENTS MAGAZINE HOLDER, BLACK / BRONZED BRASS	449,95	376,52

TECHNICAL SPECIFICATIONS

PRODUCT TYPE
Magazine holder

WEIGHT
5,8 kg / 12,8 lb

PACKAGING TYPE
Gift box

PRODUCTION PROCESS
The base is made of CNC cut marble and the top is made of bended solid brass with a bronzed and slightly brushed finish.

MATERIALS
Nero Marquina marble and solid brass.

PACKAGING MEASUREMENTS (H x W x D)
35 cm x 35 cm x 36,5 cm / 13,8" x 13,8" x 14,3"

DIMENSIONS
H: 30 cm / 11,8"
W: 33 cm / 13"
D: 29 cm / 11,4"

COLOURS
Black marble / Bronzed brass

MATERIALS & MAINTENANCE
Please see page 486 for materials and care and maintenance instructions.

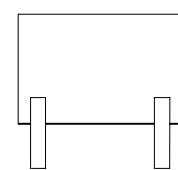

W: 33 cm / 13"

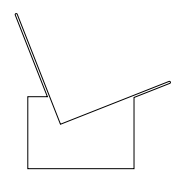

D: 29 cm / 11,4"

H: 30 cm / 11,8"

Marble Wall Clock

BY NORM ARCHITECTS

PRODUCT OPTIONS

Number-free marble wall clock with polished brass hands and concealed battery holder and mounting hole.



Black
8200539



White
8200639

STOCK OPTIONS — PRICES IN EUR *Selected combinations up to 2 weeks delivery time.*

SKU	VARIANT	INCL. VAT	EXCL. VAT
8200539	MARBLE WALL CLOCK, BLACK	269,95	225,89
8200639	MARBLE WALL CLOCK, WHITE	269,95	225,89

TECHNICAL SPECIFICATIONS

PRODUCT TYPE
Wall clock

WEIGHT
2,4 kg / 5,3 lb

PACKAGING TYPE
Gift box

PRODUCTION PROCESS
The face is made from milled, cut marble that is matte-polished. Hands are made from polished brass.

MATERIALS
Carrara and Nero Marquina marble, brass and plastic.

PACKAGING MEASUREMENTS (H x W x D)
4,5 cm x 13 cm x 21,5 cm / 1,8" x 5,8" x 8,5"

DIMENSIONS
Ø: 30 cm / 11,8"
D: 3,5 cm / 1,4"

COLOURS
Black
White

MATERIALS & MAINTENANCE
Please see page 486 for materials and care and maintenance instructions.

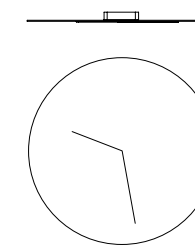

Ø: 30 cm / 11,8"

D: 3,5 cm / 1,4"

Duca Candleholder

BY KRØYER-SÆTTER-LASSEN

Polished or bronzed brass telescopic candleholder with rattan lower and adjustable screw.

PRODUCT OPTIONS



Bronzed Brass
4708859



Polished Brass
4708839

Duca Candleholders, Polished Brass, by Krøyer-Sætter-Lassen



Duca Candleholder

BY KRØYER-SÆTTER-LASSEN

STOCK OPTIONS — PRICES IN EUR *Selected combinations up to 2 weeks delivery time.*

SKU	VARIANT	INCL. VAT	EXCL. VAT
4708859	DUCA CANDLEHOLDER, BRONZED BRASS	69,95	58,53
4708839	DUCA CANDLEHOLDER, POLISHED BRASS	69,95	58,53

TECHNICAL SPECIFICATIONS

PRODUCT TYPE
Candleholder

PRODUCTION PROCESS
The candleholder stem is made from solid brass rods and machine-cut parts. Rattan is handwoven onto the stem.

DIMENSIONS
H: 16,5 cm to 24 cm / 6,4" to 9,4"
Ø: 8 cm / 3,1"

WEIGHT
0,3 kg / 0,7 lb

MATERIALS
Lacquered polished brass and rattan; bronzed brass and rattan.

COLOURS
Polished brass
Bronzed brass

PACKAGING TYPE
Gift box

PACKAGING MEASUREMENTS (H x W x D)
17 cm x 8,6 cm x 8,6 cm / 6,7" x 3,4" x 3,4"

MATERIALS & MAINTENANCE
Please see page 486 for materials and care and maintenance instructions.

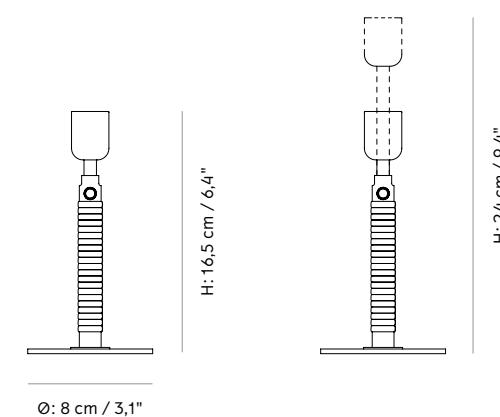

Toilet Roll Holder

BY NORM ARCHITECTS

PRODUCT OPTIONS

Black or white powder coated aluminium toilet roll holder and bracket.



Black
7640539

White
7640639

STOCK OPTIONS — PRICES IN EUR

Selected combinations up to 2 weeks delivery time.

SKU	VARIANT	INCL. VAT	EXCL. VAT
7640539	TOILET ROLL HOLDER, BLACK	79,95	66,90
7640639	TOILET ROLL HOLDER, WHITE	79,95	66,90

TECHNICAL SPECIFICATIONS

PRODUCT TYPE
Toilet roll holder

WEIGHT
0,15 kg / 0,3 lb

PACKAGING TYPE
Gift box

PRODUCTION PROCESS
Extruded aluminium holder with zinc alloy brackets.
Powder coated surface treatment for use in wet environments.

MATERIALS
Powder coated aluminium and zinc alloy.

PACKAGING MEASUREMENTS (H x W x D)
4 cm x 15 cm x 9 cm / 1,6" x 5,9" x 3,5"

DIMENSIONS
H: 2,5 cm / 1"
W: 14 cm / 5,5"
D: 8,7 cm / 3,4"

COLOURS
Black (RAL 9005)
White (RAL 9016)

MATERIALS & MAINTENANCE
Please see page 486 for materials and care and maintenance instructions.

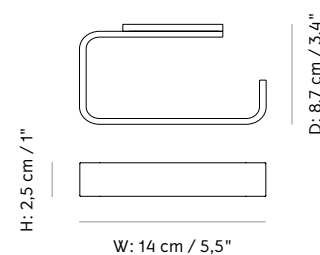

Towel Bar

BY NORM ARCHITECTS

PRODUCT OPTIONS

Black or white powder coated aluminium towel bar and bracket.

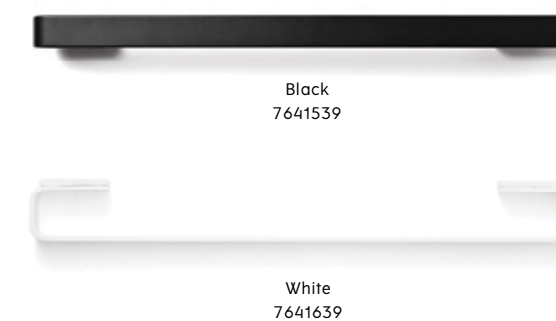

Black
7641539

White
7641639

STOCK OPTIONS — PRICES IN EUR

Selected combinations up to 2 weeks delivery time.

SKU	VARIANT	INCL. VAT	EXCL. VAT
7641539	TOWEL BAR, BLACK	119,95	100,37
7641639	TOWEL BAR, WHITE	119,95	100,37

TECHNICAL SPECIFICATIONS

PRODUCT TYPE
Towel bar

WEIGHT
0,35 kg / 0,8 lb

PACKAGING TYPE
Gift box

PRODUCTION PROCESS
Extruded aluminium holder with zinc alloy brackets.
Powder coated surface treatment for use in wet environments.

MATERIALS
Powder coated aluminium and zinc alloy.

PACKAGING MEASUREMENTS (H x W x D)
4 cm x 61 cm x 7,1 cm / 1,6" x 24" x 2,8"

DIMENSIONS
H: 3 cm / 1,2"
W: 60 cm / 23,6"
D: 7 cm / 2,7"

COLOURS
Black (RAL 9005)
White (RAL 9016)

MATERIALS & MAINTENANCE
Please see page 486 for materials and care and maintenance instructions.

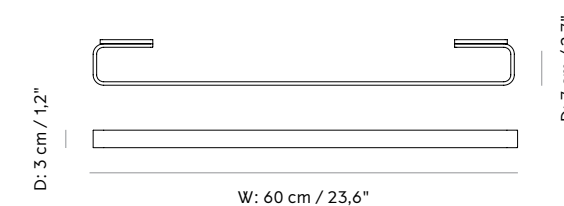

Soap Pump

BY NORM ARCHITECTS

PRODUCT OPTIONS

Easy-clean, powder coated steel container with brushed steel pump-action lid. Available in standalone and wall-mounted versions.



Black
7700519

White
7700619

Black, Wall
7710519

White, Wall
7710619

STOCK OPTIONS — PRICES IN EUR

Selected combinations up to 2 weeks delivery time.

SKU	VARIANT	INCL. VAT	EXCL. VAT
7700519	SOAP PUMP, BLACK	69,95	58,53
7700619	SOAP PUMP, WHITE	69,95	58,53
7710519	SOAP PUMP, WALL, BLACK	69,95	58,53
7710619	SOAP PUMP, WALL, WHITE	69,95	58,53

TECHNICAL SPECIFICATIONS

PRODUCT TYPE
Soap dispenser

PRODUCTION PROCESS

Deep drawn stainless steel body and cast zinc alloy brackets. Powder coated surface for use in wet environments. Pump parts made using injection moulding.

WEIGHT

Soap Pump: 0,3 kg / 0,7 lb
Soap Pump Wall: 0,4 kg / 0,9 lb

MATERIALS

Stainless steel, powder coated steel, zinc alloy, plastic ABS, PE and PP.

DIMENSIONS

Soap Pump
Ø: 8,5 cm / 3,3"
H: 11 cm / 4,4"
D: 10 cm / 4"
V: 300 ml

Soap Pump Wall
Ø: 8,5 cm / 3,3"
H: 11 cm / 4,3"
D: 12 cm / 4,7"
V: 300 ml

COLOURS

Black (RAL 9005), matte
White (RAL 9016), shiny (Gloss 95)

PACKAGING TYPE
Gift box

PACKAGING MEASUREMENTS (H x W x D)
12,5 cm x 10 cm x 10 cm / 4,9" x 3,9" x 3,9"

MATERIALS & MAINTENANCE
Please see page 486 for materials and care and maintenance instructions.

SOAP PUMP



Ø: 8,5 cm / 3,3"

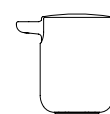

D: 10,5 cm / 4,1"

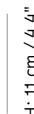

H: 11 cm / 4,4"

SOAP PUMP WALL



Ø: 8,5 cm / 3,3"

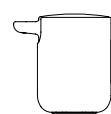

D: 12 cm / 4,7"



H: 11 cm / 4,4"

Toothbrush Holder

BY NORM ARCHITECTS

PRODUCT OPTIONS

Easy-clean, powder coated steel holder with stainless steel trim and removable plastic filter. Available in standalone and wall-mounted versions.



Black
7700509

White
7700609

Black, Wall
7710509

White, Wall
7710609

STOCK OPTIONS — PRICES IN EUR

Selected combinations up to 2 weeks delivery time.

SKU	VARIANT	INCL. VAT	EXCL. VAT
7700509	TOOTHBRUSH HOLDER, BLACK	49,95	41,80
7700609	TOOTHBRUSH HOLDER, WHITE	49,95	41,80
7710509	TOOTHBRUSH HOLDER, WALL, BLACK	49,95	41,80
7710609	TOOTHBRUSH HOLDER, WALL, WHITE	49,95	41,80

TECHNICAL SPECIFICATIONS

PRODUCT TYPE
Toothbrush holder

PRODUCTION PROCESS

Deep drawn stainless steel body and cast zinc alloy brackets. Powder coated surface for use in wet environments. Pump parts made using injection moulding.

WEIGHT

Toothbrush Holder Wall: 0,3 kg / 0,7 lb
Toothbrush Holder Wall: 0,345 kg / 0,8 lb

MATERIALS

Stainless steel, powder coated steel, zinc alloy, plastic ABS.

DIMENSIONS

Toothbrush Holder
Ø: 8,5 cm / 3,3"
H: 11 cm / 4,3"

Toothbrush Holder Wall
H: 11 cm / 4,3"
Ø: 8,5 cm / 3,4"
D: 10 cm / 4"

COLOURS

Black (RAL 9005), matte
White (RAL 9016), shiny (Gloss 95)

PACKAGING TYPE
Gift box

PACKAGING MEASUREMENTS (H x W x D)
12,5 cm x 9 cm x 9 cm / 4,9" x 3,5" x 3,5"

MATERIALS & MAINTENANCE
Please see page 486 for materials and care and maintenance instructions.

TOOTHBRUSH HOLDER

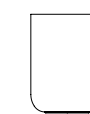

Ø: 8,5 cm / 3,3"



H: 11 cm / 4,3"

TOOTHBRUSH HOLDER WALL



Ø: 8,5 cm / 3,3"

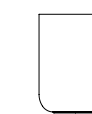

D: 10 cm / 4"



H: 11 cm / 4,3"

Shower Tray

BY NORM ARCHITECTS

PRODUCT OPTIONS

Marble and powder coated aluminium or powder coated aluminium shower tray with drainage holes, raised edges and concealed wall mountings.



STOCK OPTIONS — PRICES IN EUR

Selected combinations up to 2 weeks delivery time.

SKU	VARIANT	INCL. VAT	EXCL. VAT
7642539	SHOWER TRAY, BLACK	99,95	83,64
7643539	SHOWER TRAY, BLACK / BLACK MARBLE	129,95	108,74
7642639	SHOWER TRAY, WHITE	99,95	83,64
7643639	SHOWER TRAY, WHITE / WHITE MARBLE	129,95	108,74

TECHNICAL SPECIFICATIONS

PRODUCT TYPE
Shower tray

PRODUCTION PROCESS
Cast aluminium tray with zinc alloy bracket. Powder coated surface for use in wet environments. The marble insert is made of CNC-cut marble with a polished surface.

WEIGHT (KG)
Without marble insert: 0,4 kg / 0,9 lb
With marble insert: 0,9 kg / 2 lb

DIMENSIONS
H: 3 cm / 1,2"
W: 20 cm / 7,9"
D: 11,7 cm / 4,6"

MATERIALS
Powder coated aluminium, powder coated zinc alloy, Nero Marquina marble or Carrara marble.

COLOURS
Black (RAL 9005)
White (RAL 9016)
Black (RAL 9005) / Black marble
White (RAL 9016) / White marble

PACKAGING TYPE
Gift box

PACKAGING MEASUREMENTS (H x W x D)
5 cm x 26 cm x 17 cm / 2" x 10,2" x 6,7"

MATERIALS & MAINTENANCE
Please see page 486 for materials and care and maintenance instructions.

SHOWER TRAY

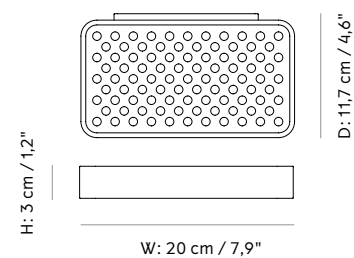

SHOWER TRAY WITH MARBLE INSERT

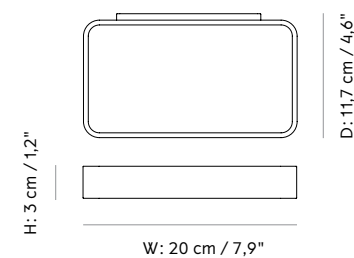

Toilet Brush

BY NORM ARCHITECTS

PRODUCT OPTIONS

Powder coated steel container with brushed steel handle with a comfortable grip, removable plastic brush head and interior plastic cannister. Available in standalone and wall-mounted versions.



STOCK OPTIONS — PRICES IN EUR

Selected combinations up to 2 weeks delivery time.

SKU	VARIANT	INCL. VAT	EXCL. VAT
7700559	TOILET BRUSH, BLACK	79,95	66,90
7700659	TOILET BRUSH, WHITE	79,95	66,90
7710559	TOILET BRUSH, WALL, BLACK	79,95	66,90
7710659	TOILET BRUSH, WALL, WHITE	79,95	66,90

TECHNICAL SPECIFICATIONS

PRODUCT TYPE
Toilet brush

PRODUCTION PROCESS
Cast aluminium tray with zinc alloy bracket. Powder coated surface for use in wet environments. The marble insert is made of CNC-cut marble with a polished surface.

WEIGHT
Toiler Brush: 1,3 kg / 2,9 lb
Toiler Brush Wall: 1,35 kg / 3 lb

MATERIALS
Stainless steel, powder coated steel, zinc alloy, plastic (PP).

DIMENSIONS

Toiler Brush
H: 39,5 cm / 15,5"
Ø: 10 cm / 3,9"

Toiler Brush Wall
H: 39,5 cm / 15,5"
Ø: 10 cm / 4"
D: 11,5 cm / 4,5"

COLOURS
Black (RAL 9005), matte
White (RAL 9016), shiny (Gloss 95)

PACKAGING TYPE
Gift box

PACKAGING MEASUREMENTS (H x W x D)
40 cm x 11 cm x 11 cm / 15,8" x 4,3" x 4,3"

MATERIALS & MAINTENANCE
Please see page 486 for materials and care and maintenance instructions.

TOILET BRUSH

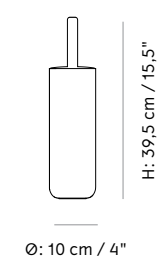

TOILET BRUSH WALL

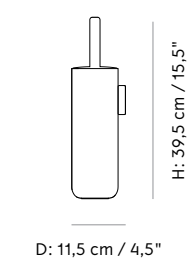

Knobs

BY NORM ARCHITECTS

PRODUCT OPTIONS

Powder coated steel knobs with concealed screws for mounting.



Black
7700539

White
7700639

STOCK OPTIONS — PRICES IN EUR

Selected combinations up to 2 weeks delivery time.

SKU	VARIANT	INCL. VAT	EXCL. VAT
7700539	KNOBS, BLACK, 2-PACK	49,95	41,80
7700639	KNOBS, WHITE, 2-PACK	49,95	41,80

TECHNICAL SPECIFICATIONS

PRODUCT TYPE
Knobs

WEIGHT
0,22 kg / 0,5 lb

PACKAGING TYPE
Gift box

PRODUCTION PROCESS
Cast steel body with powder coated surface treatment for use in wet environments.

MATERIALS
Powder coated steel.

PACKAGING MEASUREMENTS (H x W x D)
14,6 cm x 9,2 cm x 2,4 cm / 5,7" x 3,6" x 0,9"

DIMENSIONS
Ø: 4 cm / 1,6"
D: 2 cm / 0,8"

COLOURS
Black (RAL 9005)
White (RAL 9016)

MATERIALS & MAINTENANCE
Please see page 486 for materials and care and maintenance instructions.

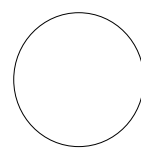

Ø: 4 cm / 1,6"



D: 2 cm / 0,8"

Wiper

BY NORM ARCHITECTS

PRODUCT OPTIONS

Seamless silicone-coated wiper with rubber trim and cord hanger.



Concrete
7700129

STOCK OPTIONS — PRICES IN EUR

Selected combinations up to 2 weeks delivery time.

SKU	VARIANT	INCL. VAT	EXCL. VAT
7700129	WIPER, CONCRETE	79,95	66,90

TECHNICAL SPECIFICATIONS

PRODUCT TYPE
Wiper

WEIGHT
0,3 kg / 0,7 lb

PACKAGING TYPE
Gift box

PRODUCTION PROCESS
Steel core with moulded silicone outer and extruded silicone string.

MATERIALS
Silicone, stainless steel.

PACKAGING MEASUREMENTS (H x W x D)
3,5 cm x 28 cm x 19 cm / 1,4" x 11" x 7,5"

DIMENSIONS
H: 2,5 cm / 1"
W: 26 cm / 10,2"
D: 19 cm / 7,5"

COLOURS
Concrete (RAL 7010)

MATERIALS & MAINTENANCE
Please see page 486 for materials and care and maintenance instructions.

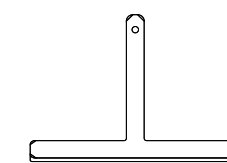

W: 26 cm / 10,2"

D: 19 cm / 7,5"

Towel Ladder

BY NORM ARCHITECTS

Powder coated steel and ash ladder with leather strap for affixing to wall.

PRODUCT OPTIONS



Black / Dark Ash
7800579



White / Light Ash
7800679

Towel Ladder, Black / Dark Ash, by Norm Architects



Towel Ladder

BY NORM ARCHITECTS

STOCK OPTIONS — PRICES IN EUR *Selected combinations up to 2 weeks delivery time.*

SKU	VARIANT	INCL. VAT	EXCL. VAT
7800579	TOWEL LADDER, BLACK STEEL / DARK ASH	419,95	347,05
7800679	TOWEL LADDER, WHITE STEEL / LIGHT ASH	419,95	347,05

TECHNICAL SPECIFICATIONS

PRODUCT TYPE
Towel ladder

WEIGHT
2,9 kg / 6,4 lb

PACKAGING MEASUREMENTS (H x W x D)
172,5 cm x 61 cm x 4,5 cm / 67,9" x 24" x 1,8"

PRODUCTION PROCESS
Bent steel rod frame with turned solid wood rungs. Powder coating ensures it is suitable for use in wet environments.

MATERIALS
Powder coated steel, ash, leather.

MATERIALS & MAINTENANCE
Please see page 486 for materials and care and maintenance instructions.

DIMENSIONS
H: 170 cm / 66,9"
W: 60 cm / 23,6"
D: 3,5 cm / 1,4"

COLOURS
Black (RAL 9005)
White (RAL 9016)

PACKAGING TYPE
Brown box

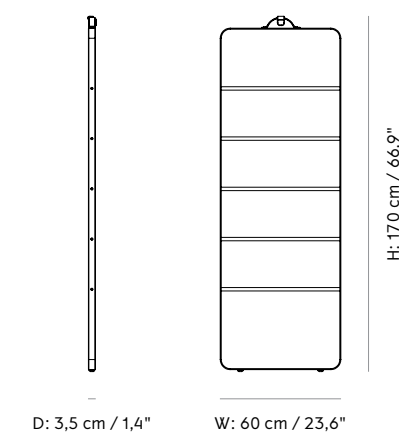

4.

Addendum

Lead Times

The opposite page provides an overview of MENU's five product categories, production and lead times, as well as a short description of each and what you can expect. Lead times denote our commitment to ensuring that your order is expedited in a timely manner, allowing you to factor the cycle into your deadlines.

Each MENU SKU is offered with a series of assets that help you to market our products and include product imagery, POS material and social media content. Furthermore, we are committed to upholding compliancy where relevant and providing service support throughout.

PRODUCT CATEGORY	DESCRIPTION	PRODUCTION TIME	LEAD-TIME PRODUCTION + SHIPPING	UK STANDART
STOCK ITEMS	Items which are in stock and ready to be shipped within 24 hours of order confirmation.	From 24 hours	Up to 2 weeks	
QUICK SHIP (QS)	Fast track stock items in predefined combinations for self-assembly.	Up to 2 weeks	Up to 4 weeks	Compliant with UK fabric and foam regulations where applicable.
RECOMMENDED COMBINATIONS (RC)	Predefined products combinations.	4 - 6 weeks	6 - 8 weeks	Compliant with UK fabric and foam regulations where applicable.
SPEC	Combinations outside QS and RC categories.	4 - 6 weeks	6 - 8 weeks	
COM	Bespoke upholstering.	6 - 8 weeks	8 - 10 weeks	

MENU Upholstery Programme

The MENU Upholstery Programme is an overview of the fabrics available for our upholstered furniture. You'll find over 100 textile and leather options, with the most popular configurations available with expedited delivery in our Quick Ship programme.

Custom upholstery orders from our MENU Upholstery Programme (SPEC) are ready to ship with standard delivery lead times. Our recommended product combinations listed in this book are fixed product variants curated by our in-house design team and deliver with standard lead times, guaranteed by supplier commitment to timeliness. These combinations have their own SKU numbers as well as pack shots that are available for download from our digital site. We are happy to upholster furniture using a customer's own materials (COM) with extended delivery lead times, upon fabric approval. Textiles or leather outside of our upholstery programme are subject to final testing and approval. Additional delivery time may also occur.

Please note that the color references in this Brand Book are only intended as a guide. For further information please see manufacturer websites, or contact your local MENU Sales Representative for samples or further information.

Textile

kvadrat.dk
sacho.com
nevotex.com
gabriel.dk
jab.de
dedar.com
astrid.se

Leather

sorensenleather.com
kvadrat.com
nevotex.com



Upholstery Selection & Furniture

Use table to determine the upholstery options available for fabric-covered items.

	AFTERROOM	AFTERROOM PLUS	EAVE	GODOT	HARBOUR	OFFSET	SEPTEMBRE	SYNNES	TAILOR	CO CHAIR	TEAROOM	KNITTING CHAIR
TEXTILE												
PRICE CATEGORY 1												
Remix 2, Kvadrat	•	•	•	•	•	•	•	•	•	•	•	•
Maple, Kvadrat	•	•	•			•	•	•	•	•	•	
Gaja C2c Gabriel	•	•	•	•	•	•	•	•	•	•	•	•
Hot Madison , JAB	•	•	•	•	•	•	•	•	•	•	•	•
City Velvet, JAB	•	•	•		•	•	•	•		•	•	
Champion, Kvadrat	•	•	•	•	•	•	•	•	•	•	•	•
PRICE CATEGORY 2												
Fiord, Kvadrat	•	•	•	•	•	•	•	•	•	•	•	•
Canvas, Kvadrat	•	•	•	•	•	•	•	•	•	•	•	•
Colline, Kvadrat	•	•	•	•	•	•	•	•	•	•	•	•
Hallingdal 65, Kvadrat	•	•	•	•	•	•	•	•	•	•	•	•
Savanna, Kvadrat	•	•	•		•	•	•	•	•	•	•	•
Steelcut 2, Kvadrat	•	•	•	•	•	•	•	•	•	•	•	•
Steelcut 3, Kvadrat	•	•	•	•	•	•	•	•	•	•	•	•
Ritz, Nevotex	•	•	•			•	•	•		•	•	
Divina Melange, Kvadrat	•	•	•	•	•	•	•	•	•	•	•	•
Clay, Kvadrat	•	•	•	•	•	•	•	•	•	•	•	•
Moss, Kvadrat	•	•	•	•	•	•	•	•	•	•	•	•
PRICE CATEGORY 3												
Vintage, Astrid	•	•	•	•	•	•	•	•	•	•	•	•
Safire, Kvadrat	•	•	•	•	•	•	•	•	•	•	•	•
Grisaille, Dedar	•	•	•	•	•	•	•	•	•	•	•	•
Ponpon, Dedar	•	•	•	•	•	•	•	•	•	•	•	•
PRICE CATEGORY 4												
Doppiopanama, Dedar	•	•	•	•	•	•	•	•	•	•	•	•
Deco, Dedar	•	•	•	•	•	•	•	•	•	•	•	•
Lupo, Dedar	•	•	•	•	•	•	•	•	•	•	•	•
Atlas, Dedar	•	•	•	•	•	•	•	•	•	•	•	•

	AFTERROOM	AFTERROOM PLUS	EAVE	GODOT	HARBOUR	OFFSET	SEPTEMBRE	SYNNES	TAILOR	CO CHAIR	TEAROOM	KNITTING CHAIR
LEATHER												
PRICE CATEGORY 1												
Ultra, Sørensen Leather	•	•			•		•	•	•	•		•
Dakar, Nevotex	•	•			•		•	•	•	•		•
PRICE CATEGORY 2												
Shade, Sørensen Leather	•	•			•		•	•	•	•		•
Dunes, Sørensen Leather	•	•			•		•	•	•	•		•
Nuance, Sørensen Leather	•	•			•				•	•		•
Instill, Kvadrat	•	•			•		•	•	•	•		•
PRICE CATEGORY 3												
Royal Nubuck, Sørensen Leather	•	•			•		•	•	•	•		•
PRICE CATEGORY 4												
Elegance, Sørensen Leather	•	•					•	•		•		

Category 1

TEXTILE



Maple, Kvadrat
Available in all colours
Composition: 81% viscose,
15% linen, 4% polyester
Durability: 30.000 Martindale



Remix 2, Kvadrat
Available in all colours
Composition: 90% new wool
(worsted), 10% nylon
Durability: 100.000 Martindale

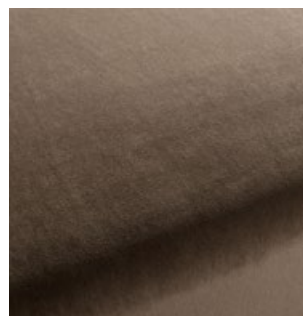

City Velvet, JAB
Available in all colours
Composition: 100% polyester
Durability: 100.000 Martindale



Hot Madison Reloaded, JAB
Available in all colours
Composition: 63% cotton,
37% linen
Durability: 55.000 Martindale



Gaja C2C, Gabriel
Available in all colours
Composition: 100%
new zealand wool
Durability: 50.000 Martindale

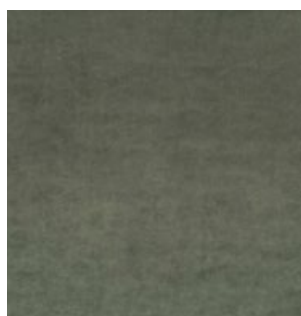

Champion, JAB
Available in all colours
Composition: 100% polyester
Durability: 70.000 Martindale

kvadrat.dk
sacho.com
gabriel.dk
jab.de
dedar.com
sorensenleather.com
nevotex.com
astrid.se

Category 1

LEATHER



Ultra, Sorensen Leather
Available in all colours
Type: Protected leather
Thickness: 0.9—1.1 mm
Surface: Very strong and durable
with a uniform, matte surface print



Dakar, Nevotex
Available in all colours
Type: Aniline leather
Thickness: 1.0—1.2 mm
Surface: Supple and flexible. Will
over time develop its own unique
character and colour distribution

Category 2

TEXTILE



Hallingdal 65, Kvadrat
Available in all colours
Composition: 70% new wool,
30% viscose
Durability: 100.000 Martindale



Savanna, Kvadrat
Available in all colours
Composition: 34% polyester,
31% new wool, 26% acrylic,
4% Cotton, 3 % Nylon, 2% Linen
Durability: 45.000 Martindale



Ritz, Nevotex
Available in all colours
Composition: 83% Cotton,
9% modal, 8% polyester
Durability: 100.000 Martindale

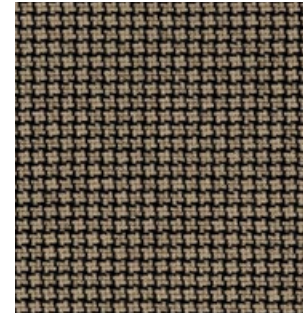

Colline, Kvadrat
Available in all colours
Composition: 75% new wool
(worsted), 17% acrylic, 8% nylon
Durability: 100.000 Martindale



Canvas, Kvadrat
Available in all colours
Composition: 90% new wool
(worsted), 10% nylon
Durability: 100.000 Martindale



Fiord, Kvadrat
Available in all colours
Composition: 92% new wool
(worsted), 8% nylon
Durability: 60.000 Martindale



Steelcut 2, Kvadrat
Available in all colours
Composition: 90% new wool
(worsted), 10% nylon
Durability: 100.000 Martindale



Steelcut Trio 3, Kvadrat
Available in all colours
Composition: 90% new wool
(worsted), 10% nylon
Durability: 100.000 Martindale



Moss, Kvadrat
Available in all colours
Composition: 52% cotton,
22% viscose, 14% acrylic,
6% linen, 3% polyamide,
3% polyester
Durability: 50.000 Martindale



Clay, Kvadrat
Available in all colours
Composition: 76% linen
21% cotton, 3% polyester
Durability: 45.000 Martindale



Divina Melange, Kvadrat
Available in all colours
Composition: 100% new wool
Durability: 45.000 Martindale

kvadrat.dk
sacho.com
gabriel.dk
jab.de
dedar.com
sorensenleather.com
nevetex.com
astrid.se

Category 2

LEATHER



Dunes, Sørensen Leather
Available in all colours
Type: Aniline leather
Thickness: 1.1—1.3 mm
Surface: An elegant, matte surface
with a velvety look and feel



Shade, Sørensen Leather
Available in all colours
Type: Protected aniline leather
Thickness: 1.1—1.3 mm
Surface: Natural markings create
unique, textural appeal



Nuance, Sørensen Leather
Available in all colours
Type: Protected aniline leather
Thickness: 1.2—1.4 mm
Surface: Visible natural markings
and two-tone texture

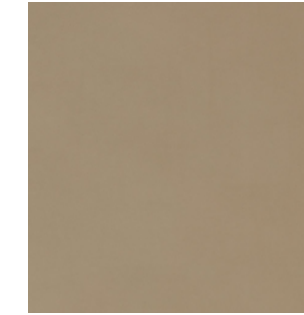

Instill, Kvadrat
Available in all colours
Type: Artificial leather
Thickness: 1.1—1.3 mm
Surface: An elegant, matte surface
with a velvety look and feel

Category 3

TEXTILE



Vintage, Astrid
Available in all colours
Composition: 90% linen,
10% polyamid
Durability: 45.000 Martindale



Safire, Kvadrat
Available in all colours
Composition: 43% viscose,
17% polyacrylic, 15% new wool,
9% cotton, 8% linen,
8% polyester
Durability: 40.000 Martindale

SARTORIALE COLLECTION



Grisaille, Dedar
Available in all colours
Composition: 50% viscose
26% cotton, 10% linen,
9% polyester, 5% acrylic
Durability: 20.000 Martindale



Ponpon, Dedar
Available in all colours
Composition: 31% polyester
30% wool, 24% acrylic,
13% cotton, 2% polyamide
Durability: 35.000 Martindale

kvadrat.dk
sacho.com
gabriel.dk
jab.de
dedar.com
sorensenleather.com
nevotex.com
astrid.se

Category 3

LEATHER



Elegance, Sorensen Leather
Available in all colours
Type: Aniline leather
Thickness: 1.2—1.4 mm
Surface: Natural finish with subtle
markings

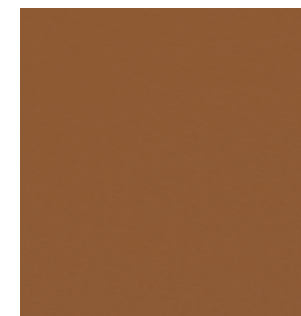

Shade, Sorensen Leather
Available in all colours
Type: Protected aniline leather
Thickness: 1.1—1.3 mm
Surface: Natural markings create
unique, textural appeal



Nuance, Sorensen Leather
Available in all colours
Type: Protected aniline leather
Thickness: 1.2—1.4 mm
Surface: Visible natural markings
and two-tone texture

Category 4

TEXTILE

SARTORIALE COLLECTION

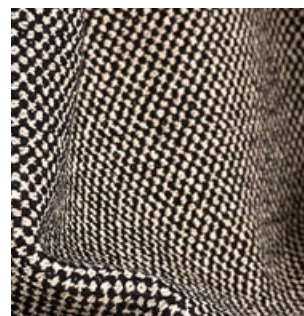

Doppiopanama, Dedar
Available in all colours
Composition: 60% cotton,
35% polyester, 5% polyamide
Durability: 35.000 Martindale



Deco, Dedar
Available in all colours
Composition: 57% cotton
33% viscose, 10% linen
Durability: 35.000 Martindale

TEXTUROLOGIE COLLECTION

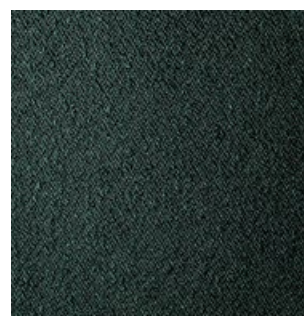

Lupo, Dedar
Available in all colours
Composition: 74% polyester FR
trevira, 26% polyester FR
Durability: 40.000 Martindale



Atlas, Dedar
Available in all colours
Composition: 72% wool
27% cotton, 1% polyamide
Durability: 26.000 Martindale

kvadrat.dk
sacho.com
gabriel.dk
jab.de
dedar.com
sorensenleather.com
nevotex.com
astrid.se

Category 4

LEATHER

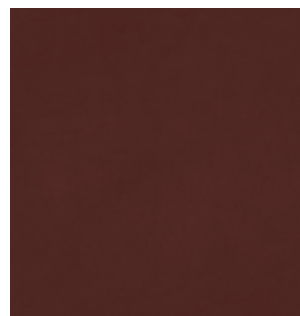

Elegance, Sorensen Leather
Available in all colours
Type: Aniline leather
Thickness: 1.2—1.4 mm
Surface: Natural surface and
subtle markings

Natural Markings – Leather

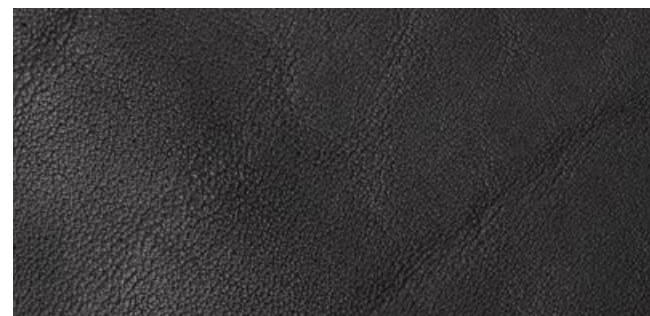

FAT WRINKLES

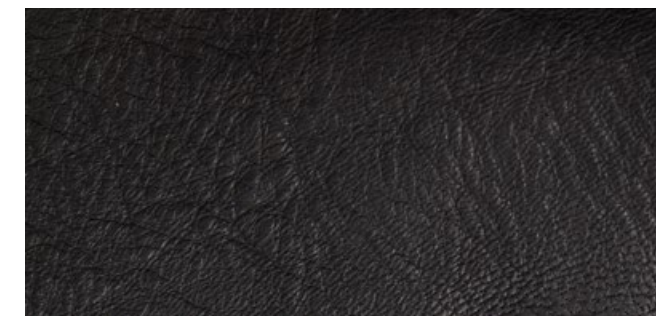

SCARS/INSECT BITES

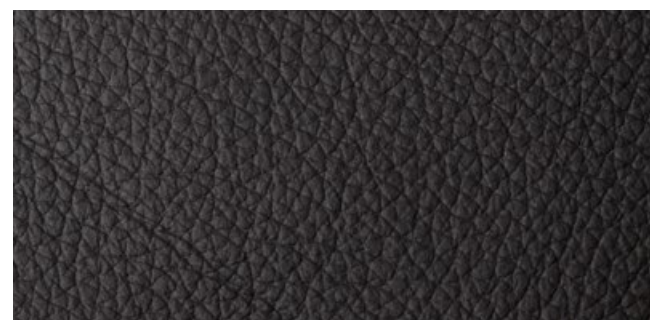

FOLDS

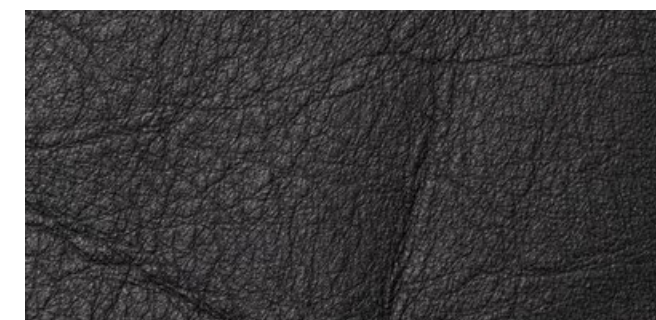

BUTCHERING SCAR

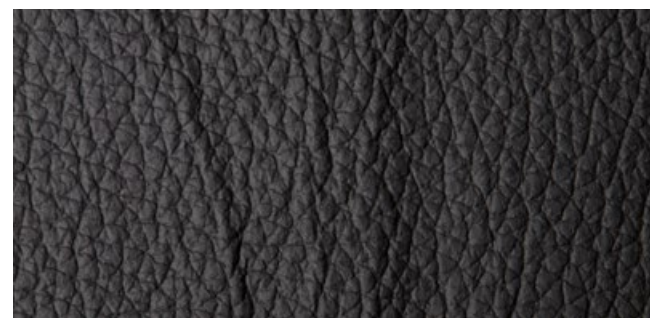

HEALED SCARS

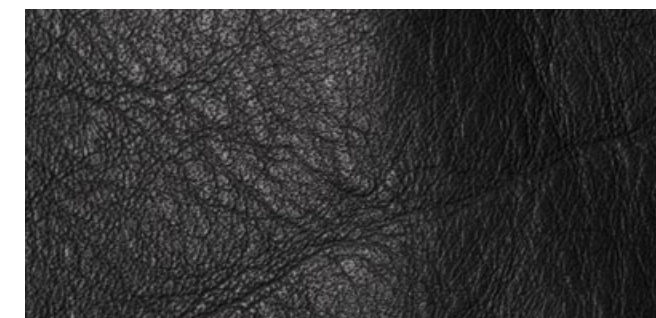

FAT WRINKLES

Individual and unique markings may appear on
the leather and should not be considered defects.

MENU Swatch Box Price List

MATERIAL	SKU	PCS	NAME	EUR INCL. VAT	EUR EXCL. VAT
Complete Sample Box					
Includes all swatches				100,00	82,64
Wood, 75 x 110 mm					
OAK	1200-28	1	Oak Veneer, Black	3,00	2,51
	1200-29	1	Oak Veneer, Light Grey		
	1200-30	1	Solid Oak, Soap Treated		
	1200-31	1	Solid Oak, Dark Stained		
	1200-37	1	Oak Veneer, Lacquered		
WALNUT	1200-32	1	Walnut, Oiled	3,00	2,51
ASH	1200-41	1	Solid Ash, White Painted	3,00	2,51
Metals, 75 x 150 mm					
BRASS	1200-33	1	Polished Brass	3,00	2,51
	1200-34	1	Brushed Brass		
	1200-35	1	Bronzed Brass		
ALUMINIUM	1200-12	1	Polished Aluminium	3,00	2,51
	1200-14	1	Bronze Grey		
	1200-54	1	Brushed Bronzed		
POWDER COATED	1200-3	1	Black, RAL 9005, Gloss 20	3,00	2,51
	1200-5	1	White, RAL 9016, Gloss 20		
	1200-6	1	Light Grey, RAL 9002, Gloss 5-10		
	1200-8	1	Ivory, NCS S 1002-Y50R, Gloss 5-10		
Textile, 150 x 150 mm					
WOOL	5850130P	1	Wool Grey	6,00	5,02
	5850640P	1	Wool Ivory		
Other					
PLEXIGLAS	1200-15	1	Tempered Glass w/silkprint, Dark Green	3,00	2,51
	1200-16	1	Tempered Glass w/silkprint , Dark Brown		
	1200-17	1	Tempered Glass w/ silkprint, Beige		
MARBLE	1200-49	1	Estremoz	6,00	5,02
	1200-48	1	Grey Kenzo		
	1200-46	1	Marquina		
	1200-47	1	Carrara		
	1200-52	1	Calcatta Viola		
	1200-53	1	Kunis Breccia		
	1200-50	1	Crystal Rose		
	1200-51	1	Atajia Azul		
LINOLEUM	1200-24	1	Charcoal	3,00	2,51
	1200-25	1	Mushroom		
HARBOUR SHELL SWATCH RING 6 PCS	1196-1	1	Black	3,00	2,51
	1196-2	1	White		
	1196-3	1	Burned Red		
	1196-4	1	Khaki		
	1196-5	1	Light Grey		
	1196-6	1	Olive		
QUICK SHIP SWATCH RING 6 PCS	1195	1	Quick Ship Swatch Ring	39,95	33,43

POS Overview

We offer tailormade material to help you market our products.

The below outlines the available content.

POS CATEGORY	SKU	POS ITEM
CATALOGUES	2020	MENU Brand Book
	2020-1	MENU Price list 2020 - DKK
	2020-2	MENU Price list 2020 - EUR
	2020-3	MENU Price list 2020 - GBP
	2020-4	MENU Price list 2020 - NOK
	2020-5	MENU Price list 2020 - EUR Overseas
	2020-6	MENU Price list 2020 - SEK
LOGO	405	Case Book Vol 2
	166	Logo, vinyl
	374	Logo, wood block
	167	Connected Spaces vinyl
	168	Doorbuster, Connected Spaces

Printed POS and Store Space displays available upon request to your local sales representative.

CONTENT PACKAGE

PACKSHOTS
LIFESTYLE IMAGES
PRESS RELEASES
PRODUCT FACT SHEETS
SOCIAL MEDIA CAPTIONS
2D FILES
3D FILES
PRODUCT VIDEOS OF HERO PRODUCTS

All content can be downloaded online at content.menuspace.com

General Terms and Conditions

1/3

1. GENERAL CONDITIONS

1.1. These General Terms and Conditions shall apply to all deliveries from MENU A/S (hereinafter “MENU”) to the purchaser (hereinafter “Purchaser”), unless otherwise agreed to by MENU in writing.

1.2. Any terms and conditions proposed by Purchaser, which are different from or in addition to the terms in these General Terms and Conditions shall not be binding upon MENU and shall be void and of no effect, except to the extent expressly accepted by MENU in writing.

2. ORDERS AND PRICES

2.1. A purchase order from Purchaser constitutes Purchaser’s offer to MENU, and it will only become a binding agreement between the parties, upon MENU’s acceptance in writing by order confirmation or otherwise.

2.2. All prices are exclusive of VAT, taxes, duties, customs and other charges and fees. MENU reserves the right to adjust prices until delivery in the event of changes in customs, duties, taxes, material and wages costs, currency conditions or other business conditions.

2.3. Any request to change a purchase order with upholstery products needs to be received by MENU within 3 working days from receipt of order confirmation to avoid any cancellation fees. In the event the products have already been dispatched, a fee for the return of the products shall be paid by the Purchaser (Refer to clause 7.4).

2.4. All purchase orders are to be placed in full master cartons. If Purchaser places an order for products in an amount that is less than a full master carton, Purchaser shall pay a handling fee per breached master carton.

3. DELIVERY AND DELAY

3.1. Unless otherwise confirmed by MENU in writing, the products shall be delivered as follows:

a) DDP (Incoterms 2010) for deliveries to countries within the European Union (EU). For UK please refer to Clause 9.2 and appendix 5a.

b) Ex Works (Incoterms 2010) for deliveries to all countries outside the European Union (EU), including but not limited to European countries outside of the European Union (EU) and Greece, however except for Switzerland.

c) DDU (Incoterms 2010) for deliveries to Switzerland. Shipments off mainland EU might be subject to an extra charge, which will be quoted separately from MENU to the Purchaser. Shipments to Switzerland are subject to a fee for custom duties, which will be quoted separately from MENU to Purchaser. Euro pallets and pallet frames used for the delivery will be invoiced to the Purchaser. Return of euro pallets and pallet frames is not accepted by MENU.

3.2. Partial delivery from MENU to Purchaser shall be permitted. Our SPEC and COM orders will be sent directly from our production sites to purchaser location unless agreed otherwise. This does not involve orders with delivery terms ex. works where collection will be from our warehouse in Brøndby, Denmark.

3.3. Upon request from Purchaser, MENU may offer to arrange for transportation of the products from the place of delivery set out in Clause 3.1 to a destination requested by Purchaser. Such transportation of the products may take place either by MENU’s own means or by contracting a third-party forwarder/transporter and the transportation is subject to an administration fee to MENU for arranging such transportation and all freight costs being paid by Purchaser. Purchaser is, at its own cost, obliged to contract for insurance coverage against any risk of loss of or damage to the products during carriage. If the products cannot be delivered by the third-party forwarder/transporter to the address provided by Purchaser, it shall – irrespective of the reason for the delivery hindrance – be considered as a missed delivery. In the event of a missed delivery, Purchaser may be offered delivery on another day or alternative delivery options subject to additional freight costs and administration fees to be paid by Purchaser to MENU.

3.4. MENU’s production lead time for chairs and tables is approximately 0-8 weeks from MENU’s acceptance of the purchase order. Some of MENU’s chairs and tables are stock items, and upon prior written acceptance from MENU these stock items can be delivered by MENU with a shorter delivery date.

3.5. Any delivery date notified or communicated by MENU is solely an estimate based on MENU’s best knowledge, and delivery dates are therefore not binding on MENU, unless a specific delivery date has been agreed in writing with MENU. If a specific delivery date has been agreed in writing, delivery within 14 working days after the agreed specific delivery date shall not be considered a delay.

3.6. In the event that delivery has not taken place within 14 working days after an agreed specific delivery date, and the non-delivery is not caused by circumstances attributable to Purchaser, Purchaser is by written notification to MENU entitled to cancel the part(s) of the order relating to the products, which has not been delivered. If the purchased products are being specifically adapted to Purchaser in accordance with Clause 7, Purchaser is not entitled to cancel the order, unless the delay exceeds 40 working days after the agreed specific delivery date. The above remedies shall be Purchaser’s sole remedies in the event of delay.

4. TERMS OF PAYMENT

4.1. Unless otherwise agreed Terms of payment are 20 days from the invoice date on Contract and 30 days on other (20 days net and 30 days net respectively). Prepayment (50% of 100%) are required for 1st time customers, orders above DKK 300k, SOR, SPEC and COM products and where credit insurance cannot be taken. Better terms can be obtained if payment is done via SEPA Direct Debit.

4.2. In the event that payment is not provided on time, MENU shall be entitled to:

- a) charge interest on the overdue amount corresponding to the official Danish discount rate (in Danish: "Diskontoen") in force from time to time with the addition of 1.5% per month, and
- b) to suspend performance of all deliveries and orders to the Purchaser without incurring any liability.

4.2.1. In general the following precautions will be taken:

- a) Overdue debt will result in stop for all deliveries.
- b) Late payments will result in loss of credit limit and requirement for prepayment on subsequent orders.

4.3. MENU seeks to insure all debtors and therefore MENU reserves the right to collect credit information on Purchaser. If credit insurance is not granted by MENU’s credit insurance company, MENU will only ship the order to Purchaser against prepayment. In such event, Purchaser must pay the entire order amount within 4 weeks from the date of MENU’s order confirmation. If payment has not been received by MENU within this period, MENU will be entitled to cancel the order.

General Terms and Conditions

5. RETENTION OF TITLE

5.1. MENU shall retain ownership of products sold to Purchaser, until payment has been effected in full with the addition of interest and possible costs. Purchaser shall not be entitled to make arrangements that limit MENU's retention of ownership.

5.2. Any deliveries of products to Germany or United Kingdom are subject to additional terms and conditions in relation to retention of title, cf. Appendix 5a and 5b.

6. LIABILITY FOR DEFECTS

6.1. MENU warrants that standard products delivered to Purchaser are free from defects in material and workmanship for a period of 24 months from the delivery date of each product (hereinafter "Warranty Period").

6.2. If Purchaser wishes to claim this warranty, Purchaser shall without undue delay notify MENU in writing of any defects. Such notice shall under no circumstances be given later than 2 weeks after Purchaser has become aware or should have become aware of the defect and at the latest before the expiry of the Warranty Period. MENU shall not be liable for any defective products whatsoever if Purchaser fails to give notice in writing to MENU after the expiry of this period.

6.3. The Purchaser shall immediately upon receipt of the products from the carrier conduct a visual inspection of the delivered products, and

6.3.1 if there are any visual damage to the packaging, this needs to be notes on the Delivery Note from the forwarder. Failing this, the Purchaser will be liable for the damage.

6.3.2 If there are any defects or shortcomings in quantity in the delivered products, this shall be notified to MENU in writing within 2 weeks after the delivery date of the products. MENU shall not be liable for any defects or shortcomings in quantity in the products whatsoever if Purchaser fails to give notice in writing to MENU after the expiry of this period.

6.4. A claim from Purchaser shall include a description of the defect and be accompanied by the necessary and relevant documentation, including information on the order number and photos documenting the defect. All claims shall be sent by e-mail to MENU's support team at: claims@menu.as.

6.5. If a delivered product is defective in any material way, MENU shall at its sole discretion be obliged to either (i) remedy the defect, (ii) replace the defective product or (iii) terminate the purchase order in respect of the defective product(s) against crediting of the invoiced amount for such defective product(s) to Purchaser. MENU shall notify Purchaser of its decision within reasonable time after receiving a claim from Purchaser. Purchaser is not entitled to other remedies in case of defects in the delivered products, and MENU shall not be liable for any other direct or indirect losses that the defect may cause.

6.6. MENU is only liable for defects which appear under the proper use of the products. MENU's liability does not cover defects arising out of or caused by (i) materials provided by Purchaser, (ii) faulty maintenance, incorrect use or incorrect assembly, (iii) alterations or repair performed by Purchaser or (iv) normal wear and tear of the products.

6.7. Complaints/replacements can only be made to the original delivery address, unless delivery has been made directly to the end consumer. I.e. if ex works delivery terms, collection site is Brøndby, Denmark.

6.8. Apart from defects and warranty claims, Purchaser are in no instances entitled to return purchased products to MENU.

2/3

7. SPECIAL ORDERS

7.1. Any purchase orders where Purchaser requests MENU to incorporate or use fabrics, leather or other materials which are provided by Purchaser (hereinafter "COM/COL Products") will only become a binding agreement between the parties upon MENU's acceptance of the order in writing. Refer to clause 4.1. MENU is not responsible for any defects in fabrics, leather or other materials provided by Purchaser.

7.2. Any purchase orders where Purchaser requests MENU to deliver products with fabrics, leather or other materials, which are part of MENU's range of materials that can be selected for MENU's products (hereinafter "SPEC Products") are considered non-standard products by MENU.

7.3. Any purchase orders where Purchaser requests MENU to manufacture a bespoke product (hereinafter "SOR products") will only become a binding agreement between the parties upon MENU's acceptance of the order in writing and Purchaser's prepayment of 100% of the total purchase price under the purchase order. Standard warranty of 24 months applies.

7.4. If Purchaser cancels a purchase order for COM/COL Products or SPEC Products after MENU's acceptance of the purchase order, however subject to Clause 3.6 above, Purchaser shall pay cancellation fee to MENU as follows depending on timing of cancellation from receipt of order confirmation:

- Less than 72 hours after order confirmation: 0% on net price ex. VAT
- Between 73 hours and 10 days: 20% on net price ex. VAT
- More than 10 days: 100% calculated on net price ex. VAT.

Cancellation of purchase orders with SOR products is not accepted and the total purchase price under the purchase order is to be paid.

8. MARKETING

8.1. All advertisements, catalogues and other printed material containing MENU's logo and MENU's product descriptions, or pictures may only be used upon and according to prior written agreement with MENU. MENU reserves all intellectual property rights to such material and the right at any time to require the return or destruction of such material.

8.2. All our marketing material is subject to errors and omissions.

9. FORCE MAJEURE

9.1. MENU shall be exempt from any liability for non-performance of its obligations to the extent its performance is affected by force majeure. Force majeure shall include, but is not limited to, war, riot, fire, natural catastrophes, embargoes, industrial disputes, breakdown in production facilities, limited capacity, lack of motive power and other circumstances not reasonably foreseeable by and beyond the control of MENU, including force majeure of its sub-contractors. If an event of force majeure persists for more than 6 months, either party is entitled to terminate any affected purchase order.

9.2. Force majeure as described in Clause 9.1. shall include any event originating from Brexit. Brexit occurs when The United Kingdom (UK) formally stops being a member of the European Union (EU). Such events shall include, but is not limited to, delivery delay or hindrance, tariffs/duty/customs, etc. being imposed upon the sale of MENU's products to the UK, change in the laws applicable to MENU's delivery of products in the UK or the laws applicable to MENU's delivery of products in the UK ceasing to be substantially similar to those applicable in the EU.

If delivery delay or hindrance is caused by events originating from Brexit, it shall be considered as a missed delivery for which MENU is not responsible. If tariffs/duty/customs, etc. are imposed upon the sale of MENU's products to the UK, those tariffs/duty/customs, etc. shall be paid by the Purchaser. If there is any change in the law applicable to MENU's delivery of products in the UK, or if the laws cease to be substantially similar to those applicable in the EU, the Purchaser shall be responsible for ensuring compliance with such laws.

10. PRODUCT LIABILITY

10.1. MENU shall only be liable for damage caused by MENU's products in accordance with the mandatory provisions of the Danish Product Liability Act. MENU shall under no circumstances be liable for any indirect or consequential loss or damage, including but not limited to loss of profit, operating loss, loss of goodwill and loss of any contract.

10.2. Purchaser shall indemnify and hold MENU harmless to the extent that MENU incurs any liability towards any third party in respect of any damage for which MENU is not liable towards Purchaser.

10.3. If a claim for damage is raised by a third party against one of the parties, this party shall inform the other party thereof in writing without undue delay.

10.4. The limitation of MENU's liability set out in Clause 10.1 shall not apply where MENU has been guilty of gross negligence.

11. LIMITATION OF LIABILITY

11.1. MENU shall in no event be liable for any indirect or consequential loss or damage, including but not limited to loss of profit, operating loss, loss of goodwill and loss of any contract.

11.2. MENU's total and aggregate liability under or in connection with any purchase order shall in no event exceed the invoiced amount of such purchase order.

11.3. MENU shall not be liable for any errors in catalogues, brochures or other printed material submitted to Purchaser.

11.4. The limitation of MENU's liability set out in this Clause 11 shall not apply where MENU has been guilty of gross negligence.

12. CHOICE OF LAW AND VENUE

12.1. These General Terms and Conditions and any purchase order are subject to Danish law, excluding its provisions on choice of law.

12.2. Any dispute arising out of or in connection with these General Terms and Conditions or a purchase order shall be settled by the city court of Copenhagen.

Materials & Maintenance

GENERAL MAINTENANCE

Please find below general maintenance guidelines for all MENU products.

- Always follow the instructions for the specific product and material.
- Always begin with mild cleaning agent.
- Never use any cleaners with chemicals or harsh abrasives.
- To preserve the color of the materials, direct sunlight should be avoided as much as possible.
- Never place your products close to a heating radiator or other similar appliances.
- Always protect surfaces against hot, humid or colored items i.e. vases, candlelight, pots.
- Items for indoor use only, should never be used outdoors.
- For all products made from natural materials, there will be variations, and therefore, making every product unique.
- Remember to tighten assembly screws if the joints are loose.

GENERAL MAINTENANCE FOR WOOD

During its lifespan, wood changes, particularly when exposed to sunlight, which can cause gradual color and structure changes to appear over the years, with the largest being seen during the first couple of months.

Furthermore, as wood absorbs and emits humidity depending on in which climate it is placed, furniture should be placed in rooms with a relative air humidity of 40–50% and approximately 20°C. Due to this temperature and humidity sensitivity, we recommend to treat wood during the winter months, optimally before and after the season. Furthermore, solid wood may become rugged or slightly winded – again, this is caused by temperature and humidity changes.

Daily maintenance can be carried out using a well wrung out cloth and clean water. Never use detergents.

SOAP TREATED WOOD

Soap treatment on wood is a very light dirt-repellent surface treatment. Therefore, it does not mean that the wood surface is fully repellent to anything, but it gives the user a chance to act in case of spills, etc., so that the wood does not soak moisture in immediately.

However, if moisture is left on the surface over time, it will stain the top – this includes oil-treated wood surfaces. The surface treatment is primarily applied on products where the most natural aging of wood is wanted, but with some dirt-repellent properties.

General rule of thumb for soap treatments is: A new table should be treated 2-3 times in the first 3 weeks to wear in the soap and keep the table top light in colour. After that the table should be treated if it gets too dark in color, dry or dirty – approximately every 2-3 months. Soap mixture should be applied with a wrung out soft sponge or cloth. The mixture should be applied only in direction of the grains – evenly and without leaving any spots, stains or thick lines. The sponge or cloth should then be well wrung out (as much as possible so that it is almost dry) and the soap mixture dried off. **Remember to also treat the bottom of the table top to avoid the wood from twisting.**

After the first couple of treatments it is perfectly normal that the fibers in the wood lift themselves.

When the wood is dry, sand it gently with sandpaper (180–240) or a sanding-sponge in the direction of the grains. Wipe dust away.

PAINTED WOOD

Painted furniture is simple to keep clean. On a weekly basis, dust or wipe clean with a damp cloth. If using water, be sure not to leave water spots on the surface, which can leave permanent marks when drying out.

1/4

VEENER

Wood veneer is made from logs of solid wood being cut into thin sheets – the sheets can then be applied to a base of MDF, plywood or chipboard. The veneer is only approximately 1,2mm thick, so veneered surfaces should not be sanded. Given that the veneer is made from real wood, natural differences in the wood can occur.

It is recommended that veneered surfaces should be cleaned using a dry cloth. Water and damp cloths may not be used for cleaning, as this will damage the veneer.

In case of spots, they have to be removed using a well-wrung cloth. The surface must be dried immediately after the spots have been removed, so that no liquid of any kind remains.

LINOLEUM

Linoleum is a unique material, renowned for its elegance and durability. Made of natural ingredients, the unique aesthetic and tactile properties of the material ensures that every object develops its own character. Combining a matte surface with a warmer, softer texture bestows furniture with a truly distinctive look and feel.

Following these guidelines will ensure that the appearance of the linoleum top is retained.

Regular cleaning with a damp cloth and a neutral cleaner is advised. As a regular cleaner you may use Forbo Monel diluted 0,5 cl. to 10 litres of water. For periodic maintenance and in order to maintain the linoleum surface, the supplier recommends Monel diluted 0,5 cl. to 10 litres of water. If the surface has been neglected or worn, the supplier suggests Forbo Monel diluted 1:10 with water to restore the surface desired appearance.

Do not use alkaline or alcohol-based cleaning products since it will damage the surface.

LAMINATE

A material made from several layers of paper forced together with melamine-based resins under high-pressure. This creates a surface that is easy to maintain and one highly resistant to wear and tear.

Features

- Easy to maintain
- Hardwearing
- Dirt and water repellent

Use a clean, damp cloth or sponge along with mild natural soap, detergent or similar and wipe it. Be sure to choose a natural kind, with a pH about 7.

To keep your laminate furniture looking great, you will also want to keep it out of direct sunlight. This will reduce any fading effects.

MARBLE & STONE

The beauty of marble and stone is that no two pieces are the same. Formed over thousands of years, each piece bears the trace of its history. So expect natural imperfections and markings – they make your marble unique. A little care and maintenance will reward you with a lifetime of service.

To respect the authenticity of the natural stone, the marble is treated with a sealer, providing an optimal compromise between a natural finish and functionality. The sealer leaves a satin smooth surface that is repellent to liquids and dirt, however liquids, such as coffee, tea and juices should never be left to dry on the marble as it will damage the surface. Never place acidic fruit on a marble surface. Also avoid using chemicals and corrosive.

To avoid damage, use trivets, coasters and placemats to protect from hot dishes or anything that may scratch or stain the surface. If you do have an accident, blot spills with paper towels (don't rub – it will spread the liquid). Use a pH neutral detergent or stone soap to prevent the stain from drying out or absorbing into the stone.

Be gentle with marble. Dust once or twice a week with a soft cloth (microfiber). Wash from time to time with a cloth dampened with warm water, if necessary, adding a small squeeze of pH neutral dishwashing liquid. Take care removing the soap with a fresh damp cloth. Don't use

Materials & Maintenance

abrasive cloths, sponges or wire pads, which may scratch the surface. We recommend a specialist natural stone soap to treat difficult stains. Never use acidic detergents (such as bathroom cleaners) or detergents containing bleach. Thoroughly rinse with clean water to remove all traces of soap.

Please note, sealer must be maintained every 8–12 months depending on the use.

CONCRETE

Concrete is a porous and organic looking, and as it is used day-to-day, it will take on a perfectly imperfect look. This gives the piece character and a unique aesthetic for years to come. Concrete is a natural product and will behave like one, please remember this and follow care instructions to extend the life of your concrete item.

Clean concrete periodically will extend its service life and enhance its beauty. The concrete surface can be cleaned with mild soap and water and then dried with a soft cloth.

CERAMIC

For ceramic surface, normal dishwasher liquid can be used. For stains, please use a light soap such as dishwashing soap on a wet cotton cloth. We recommend using a cloth to dry, afterwards.

In general, do not use any cleaners with chemicals or harsh abrasives for ceramic surfaces.

GLASS

Menu uses both soda lime glass and borosilicate depending on the type of product. Furthermore, we use mirror glass, for all the mirrors in our product range.

Soda Lime Glass

For Soda lime products all items are mouth blown and handcrafted, which means that each item is unique and has its own character.

For mouth blown soda lime glass, the characteristics can be minor air bubbles, slight variations in shape or thickness, which also can have effect on the colour tones.

Borosilicate

Borosilicate glass is an “engineered“ glass developed specifically for use in laboratories and applications where thermal, mechanical and chemical conditions are too harsh for standard, household-type soda lime glass. We use this type of glass for items holding very hot liquids.

Care & Cleaning

For daily cleaning of glass, use a dry soft cloth. For heavy staining, use a soft brush in combination with a standard dishwashing detergent and then rinse with a Vinegar-Water solution.

Finish off drying using a soft dry lint free cloth afterwards. Avoid using abrasive cleaning agents or chemicals on glass, as this will damage the surface.

Mirror Glass

Every time a mirror is moved there is a risk of damage. Therefore, keep any movement to a minimum.

To clean mirror glass, the best and safest way is to use a soft clean cloth with warm water. Be sure to not allow edges of mirror to remain wet for extended periods of time.

Do not use any acidic or alkali cleaners on the mirror. Never use abrasive cleaners or powders and never use abrasive cleaning instruments like steel wool.

For more thorough cleaning, use commercial glass cleaners that contain no ammonia or vinegar.

2 / 4

PORCELAIN / CERAMIC

We utilise 2 types of glazes, colour glaze or reactive glaze:

Colour Glaze

A transparent glaze provides a magical depth of color, which has not been seen before in porcelain.

At the same time this type of glaze reveals many minor details in the stoneware, normally not visible. We see this is a natural characteristic of the product’s design. The watercolor effect of the glaze makes it deliberately imperfect, and leaves the mark of a handmade product.

Reactive Glaze

Variegated, or mottled, glazes are those that do not have a homogeneous solid color or character (i.e. like a ceramic sink or toilet bowl). They are called 'reactive glazes' because they contain higher percentages of fluxes and additions intended to produce one or more variables.

A variety of mechanisms are used to create the variations in color and texture. These include crystal growth, addition of speckling agents, phase separation, layering, and opacity variations (occurring with thickness variations).

Water Colours

Water colours and the differences in thickness and colouring in the glaze may reveal the porcelain’s underlying natural surface, but this is a desired effect, enhancing the natural beauty of the porcelain

Care & Cleaning

To retain the quality of your piece and ensure longevity, use a non-abrasive cloth or sponge and warm soapy water to clean. We recommend using a cloth to dry afterwards.

However, the products are also dishwasher and microwave safe. Avoid placing in extreme hot or cold environments, such as an oven or freezer, as this could cause thermal shock and result in fragility and cracking and/or breakage.

In general, do not use any cleaners with chemicals or harsh abrasives for porcelain and ceramic surfaces.

Black Lines on dining ware is often caused by cutlery, especially on matte glazed surfaces, which tend to be more open pored than high glossed glazes.

The black lines can normally be removed by using either vienna lime, ceramic cleaner, soda powder or a small dose of vinegar. Use a scouring pad with moderate strength to remove the stains. Rinse well after cleaning.

Please note actual scratches cannot be removed using this method.

Our thermo cups consists of two cup parts (inner and outer wall) ensuring a cool touch when filled with hot liquids.

The cup appears to be thick, robust and heavy. In reality, the two connected cups are thinner than a normal cup and therefore the thermo cup is more vulnerable.

The cups are not weaker than other porcelain cups and can be used on a frequent daily basis. However, breakage can be caused easily by a hard knock or blow, breaking the one part of the two thin cups.

If a thermo cup is leaking, it may be caused by a defected closing of the small hole in the bottom of the mug. This hole is made for technical reasons, and it is closed with a paste after the final burning. If leaking occurs please allow the cup to dry out completely before closing the hole with silicone glue.

Materials & Maintenance

METALS

Metal is a common description for metallic elements or alloys of these. Most well-known metals are iron, copper, zinc, aluminium, tin, lead and alloys, such as steel, brass and bronze.

Brass

MENU items in solid brass come in different surfaces and finishes. Polished brass, brushed brass and bronzed brass.

Brass is a metallic alloy made from the combination of copper and zinc.

Regarding natural materials, variations can occur from one product to another. Every product will be unique.

Untreated brass will naturally oxidize from the moment it is exposed to air, and therefore, some items may already have darkened spots. This is not a flaw, but the natural beauty of solid brass.

Polished, Brushed & Bronzed Brass

To keep the polished or brushed brass look - use a mild metal polish and a soft cloth, and avoid using water. Polishing creams and/or polishing cloths can be bought in most retail stores.

To keep the bronzed brass look, wipe with a soft dry cloth to clean. Do not use any cleaners with chemicals or harsh abrasives. Avoid using water.

Please note, hard polishing will remove the fine hairlines in the brushed brass surface over time, as well as the bronzed surface, the silver and plated surface.

Polished Brass w. Lacquer

Some of the brass products are with a lacquer to protect the surface from oxidizing.

To clean treated brass, use a soft dry cloth. Do not use any cleaners with chemicals or harsh abrasives. Avoid using water.

STEEL & ALUMINIUM SURFACES

The different types of metal surfaces, which are used for MENU's products, are simple to keep clean and resistant to both dirt and liquids.

We use plated, anodized, lacquered and stainless steel, as well as powder coated steel. To understand the surface, plating, anodizing and powder coating is clarified below.

Plating refers to a variety of surface finishes where solid metal vaporized and deposited on to electrically conductive materials (steel, etc.) as pure metal or alloy coating. This provides a thin metallic film on to the base material.

Anodizing is an electrolytic process used to increase the thickness of the natural oxide layer on metals. By pairing it with paint primers, the process creates a durable and corrosion and wear resistant surface. The process is most commonly used on aluminium.

Powder coating is a painting process most commonly used on metals, such as steel, aluminium, etc. - paint is applied as a dry powder, which is then melted/cured under heat (around 200°C - 400°C). The surface is hard and much tougher than conventional paint.

Plated, anodized, lacquered or stainless steel

Use a soft dry cloth to clean. Do not use any cleaners with chemicals or harsh abrasives. Avoid using water. Please note hard polishing will damage the surface.

Powder coated steel

These surfaces are durable, and easy to keep clean. For cleaning, use a soft dry cloth to clean. Do not use any cleaners with chemicals or harsh abrasives. Avoid using water.

3/4

UPHOLSTERY

All MENU upholstered furniture can be upholstered in a large selection of textiles and leather.

The upholstery used for MENU's furniture is supplied from some of the industry's most respected companies. These firms have extensive knowledge on how to best take care of specific textiles. We, therefore, advise you to please visit the respective company website for further information about how to care for your products.

Although our upholstered furniture is made to last, the pieces will create their own patina over time.

As the items are built from various foam, wood, constructions, the pieces will, depending on their area of use, acquire various deformations in the foam.

If your furniture has loose cushions, it is a good idea to turn the cushions around periodically to ensure they are exposed to uniform wear.

Down-filled cushions should be fluffed and plumped up regularly (dependent on usage) to ensure that the down is equally distributed inside the cushion to maintain the shape of the cushion.

Textiles are dyed independently, meaning that color variance from batch to batch can occur.

The same is applicable to leather due to the tanning process.

Textiles

For cleaning textiles at home, use a vacuum (soft brush) frequently, ideally every week, at half power where appropriate.

Warning - do not rub the material too harshly, as this could result in loss of color or potentially damage the nap.

Leather

We are working with three types of leather, Aniline Leather, Semi-Aniline Leather, and Protected Leather, furthermore Nubuck. The care and cleaning is the same for the different types of leathers.

Care & Cleaning

- Avoid placing the leather in direct sunlight or extreme heat
- Clean using foam from soap flakes for housecleaning
- Avoid soaking the leather or bringing it in contact with sharp objects
- To absorb any spills, use a clean, dry cloth immediately
- To dust, use a vacuum cleaner with a soft brush regularly
- NEVER use detergents, ammonia, oils, polish, varnish
- Clean using soap flakes
- Use a ½ decilitre of soap flakes to a litre of hot water
- When the water is room temperature, apply the foam over the leather with a soft cloth (only use the foam and avoid soaking the leather)
- When the leather is dry, polish it with a soft, dry cotton cloth

Aniline Leather

This exclusive type of leather is of premium quality - a soft and genuine leather, crafted from highend raw hides. Aniline leather is completely 'nude', meaning that all will be visible on the leather as one could say that the life of the cow is reflected on the leather itself; from neck and fat wrinkles to scars and bite marks - all of these subtle, natural markings bring a unique quality to each hide. Furthermore, a slight variation in colour will appear due to all hides absorbing the tanning process slightly differently, giving each a truly one-of-a-kind appearance, which will only be enhanced over time as the leather ages.

With open pores, similar to that of human skin, the temperature of the leather will match the temperature of the human body, offering additional comfort for the user when seated. MENU chooses to utilize aniline leather due to its natural look, subtleness and sublime tactile feel that improves as it wears and tears.

Semi-aniline Leather

Semi-aniline leather is ideal for those who desire the natural structure of Aniline Leather, but also long for easy maintenance. What distinguishes aniline leather and semi-aniline leather is its thin surface finish - a light, pigmented surface protects semi-aniline leather against stains and the whitening effects of light, all while continuing to retain its organic look and feel, providing each hide with a more uniform colour. The surface treatment disguises some of the natural markings on the leather - however, it should be noted that neck and fat wrinkles continue to remain visible.

What results is a full-grain leather that's simple to maintain and resistant to wear and tear, offering maximum ease of use. Meanwhile, the leather's open pores similar to that of human skin provides great seating comfort, as the temperature of the leather will adjust to that of the human body. At MENU, we choose to work with semi-aniline leather due to its low-maintenance without it losing that natural look and feel of leather we all adore.

Protected / Corrected Leather

Developed for ultimate durability, Protected/Corrected leather has a special surface treatment, which guards against wear and tear, making it water repellent, dirt repellent and stain resistant. The hides have been sanded to remove some of the natural markings on the leather. As a final treatment, a grain pigment is added to create a more uniform look to the surface's color and structure.

The leather is soft and comfortable, easy to maintain and designed to last for generations. At MENU, we appreciate Protected/Corrected leather for its high durability, simple maintenance and ease of use no matter the seating area it will be utilized in.

Nubuck

Avoid contact with water, liquids or creams. Suede and nubuck must not be cleaned with water or soap flakes. Instead use a vacuum cleaner with a soft brush.

WOOL RUG

Each rug is unique, each one hand-woven by different masters. The handmade rugs have imperfections and varying textures due to their handmade nature, which adds to the overall value, interest and characteristic of the carpet. Due to using un-dyed natural colours of wool, the rugs might have different shades/nuances that add, however, to the character and charm of the carpet.

Our wool rugs are for indoor use only. Avoid using in damp areas, such as basements, bathrooms and kitchens.

Exposure to direct sunlight may result in color fading. Always keep away from sharp objects and open fire.

Care & Cleaning

Remove spills immediately. If liquid is spilled, blot with a clean undyed cloth by pressing firmly around the spill to absorb as much as possible.

Hand brush or light vacuum regularly to prevent dust and crumbs from setting on the roots of the fibres.

Do not dry clean. Occasional professional rug cleaning is recommended.

Wool rugs are made from animal fibers. If the rug gets wet, it may take on unpleasant odors. Removing and preventing this requires drying the rug well. If your wool rug takes too long to dry, the ripe smell might start to mingle with mildew smell. Wool rugs in darker or cooler rooms are likely to stay wet for longer than rugs in warmer and sunnier rooms.

Take the rug outdoors and let it dry in the sun. Hang it over a clothing rack or rail. Depending on your climate and the season, it might take up to a week for the rug to dry. Bring it inside at night to prevent it from being covered with dew in the morning. Turn it over when you take it back outside, so both sides dry properly.

Use a fan if the smell persists, you live in a damp climate or you live in an apartment with no outdoor space. Move the fan around the edges of the rug, so it dries evenly, turning it over occasionally to dry the other side.

Sprinkle the rug with baking soda once it's completely dry. Allow the baking soda to sit for 30 minutes and then vacuum the rug. If the smell persists, sprinkle the rug with additional baking soda and let it sit longer before vacuuming. Another way is to sprinkle soda underneath the carpet for a period of some days before using a vacuum to remove the soda.

Add 2 tablespoons of tea tree oil to 1 cup of water in a spray bottle. Shake up the mixture and mist it very lightly all over the rug. Allow one side to dry, then turn the rug over and repeat on the other side. Tea tree oil is a natural antiseptic that helps neutralize mold and mildew.

RATTAN

Rattan is a natural material, so every item made with rattan, will be unique. There will be color variations – a characteristic part of natural materials.

For daily cleaning, wipe with a dry cloth. Once a month, use 1 tablespoon of soap flakes to 1 L of warm water and allow the solution to penetrate into the rattan. Any remaining water can be wiped off with a clean, damp cloth.

RUBBER & SILICONE

To clean rubber and silicone, use a mild detergent, baking soda and non-abrasive scrub brush.

Wash the rubber or silicon with the mild detergent, hot water and a non-abrasive scrub brush. Apply light pressure as you scrub in a tight circular motion. Afterwards, rinse and feel for the areas that still have a sticky film or molded patches.

Apply baking soda onto the areas that have a sticky film or molded patches. Gently scrub the baking soda into the surface with a wet non-abrasive scrub brush. After the scrub, rewash with a mild detergent, hot water and a non-abrasive brush to remove the baking soda.

Proceed with additional applications of the baking soda until it is completely clean.

PLASTIC

Clean the plastic surface by wiping it with a dry cloth. For removing dirt, use a cloth with lukewarm water. If this doesn't remove dirt, use a mild detergent.

Do not use any cleaners with chemicals or harsh abrasives, as these could result in scratches.

Variations In Natural Materials

Natural materials, including but not limited to wood, wood veneer, stone, marble, leather, stoneware and porcelain, display natural markings and/or irregularities that make each product unique. Variations in colour and texture are therefore to be expected and are not considered defects, but rather indications of the material's natural origin.

HANDCRAFTED MATERIALS

Items made by hand from materials such as glass and porcelain may vary in weight.

Androgyne Lounge Table, by Danielle Siggerud
Reverse Table Lamp, by Aleksandar Lazic
Knitting Chair, Dark Stained Oak / Dakar 0311, by Ib Kofod-Larsen
Tailor Sofa, Dark Stained Oak/Dakar 0311, by Rui Alves
Gravel Rug, Ivory, by Nina Bruun



