

Recommended Prices

Ex. VAT - EUR - January 2024

Version 24.03



Fredericia





Content

Visual index	04
Material information	10
Fredericia Standard Fabrics	12
Graded-in Fabrics	13
Fredericia Leather	14
Graded-in Leather	15
Customer Care & C.O.M. upholstery	16
Table size seating overview	17
Terms & Conditions of Sale and Delivery	19
Pricelist	
Chairs & stools	23
Lounge chairs	105
Sofas	151
Tables	240
Small tables	286
Storage	321
Complements	327
Material Samples & Care Kits	347













Chairs & Stools

COLLECTION	PAGE
BM61 & BM62 Borge Mogensen	24
Eyes Johannes Foersom & Peter Hiort-Lorenzen	28
Flamingo Johannes Foersom & Peter Hiort-Lorenzen	33
J39 Mogensen Chair Borge Mogensen	34
Klint Chair Kaare Klint	36
Lynderup Chair Borge Mogensen	38
Mogensen Bench & Chair Borge Mogensen	43
Pato 4 Leg Welling/Ludvik	45
Pato Wood Base Welling/Ludvik	49
Pato Sledge Welling/Ludvik	51
Pato Office Welling/Ludvik	59
Pato Executive Welling/Ludvik	62
Pioneer Maria Bruun	67
Plan Chair Edward Barber & Jay Osgerby	69
Post Cecilie Manz	75
The Spanish Dining Chair Borge Mogensen	77
Soborg Borge Mogensen	80
Spine Metal Base Space Copenhagen	87







Chairs & Stools

COLLECTION		PAGE
Spine Wood Base Space Copenhagen		89
Swoon Dining Space Copenhagen		92
Trinidad Nanna Ditzel		94
Yksi Thau & Kallio		103











Lounge Chairs

COLLECTION		PAGE
A-Chair Jens Risom		106
The Canvas Chair Børge Mogensen		108
Corona Chair Poul M. Volther		111
Ditzel Lounge Nanna Ditzel		113
Eyes Lounge Johannes Foersom & Peter Hiort-Lorenzen		115
Gomo Lounge Hugo Passos		119
The Hunting Chair Børge Mogensen		121
Mogensen 22 Collection Børge Mogensen		123
Mono Birgitte Due Madsen & Jonas Trampedach		126
Pato Lounge Welling/Ludvik		129
Savannah Monica Förster		130
The Spanish Chair Børge Mogensen		132





Lounge Chairs

COLLECTION		PAGE
Spine Lounge Space Copenhagen		134
Swoon Lounge Space Copenhagen		136
Wegner 1788 Lounge Chair Hans J. Wegner		140
Wegner J16 Rocking Chair Hans J. Wegner		142
Wegner Ox Chair Hans J. Wegner		146
Wegner Queen Chair Hans J. Wegner		148









Sofas

COLLECTION		PAGE
Calmo Hugo Passos		152
Delphi Hannes Wettstein		167
EJ220 Erik Jørgensen	 ERIK JØRGENSEN	185
EJ280 Erik Jørgensen Studio	 ERIK JØRGENSEN	189
EJ295 Erik Jørgensen Studio	 ERIK JØRGENSEN	201
EJ315 Erik Ole Jørgensen		205
Gomo Sofa Hugo Passos		208
Haiku GamFratesi		210
JG Sofa Jørgen Gammelgaard		212
Konami Damian Williamson		214







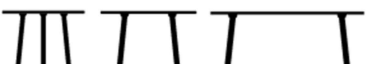

Sofas

COLLECTION		PAGE
Mogensen 22 Collection Børge Mogensen		218
Mogensen 23 Collection Børge Mogensen		224
Nami Damian Williamson		226
No.1 Børge Mogensen		230
Savannah Monica Förster		232
Spine Space Copenhagen		234
The Spoke-Back Sofa Børge Mogensen		235

Tables

COLLECTION		PAGE
Ana Table Arde		241
BM71 Library Table Børge Mogensen		243
Mogensen Dining Tables Børge Mogensen		244
Islets Maria Bruun		253
JG Table Jørgen Gammelgaard		254
Pato Table Welling/Ludvik		256
Plan Table Edward Barber & Jay Osgerby		259
Post Cecilie Manz		278
Taro Jasper Morrison		282

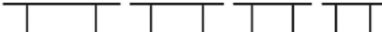

Coffee & Side Tables

COLLECTION		PAGE
BM67 Coffee Table Børge Mogensen		287
Insula Anne-Mette Bartholin Jensen & Morten Ernst		288
Islets Maria Bruun		292
JG Coffee Table Jørgen Gammelgaard		294
Niveau Cecilie Manz		295
Pal Keiji Takeuchi		298
Piloti Hugo Passos		300
Pon Jasper Morrison		309
Tableau Space Copenhagen		313
Wegner Ox Table Hans J. Wegner		316









Storage

COLLECTION		PAGE
BM29 Shelf Børge Mogensen		322

Complements

COLLECTION		PAGE
BM Nesting Tables Børge Mogensen		328
Fellow & Meadow Space Copenhagen		329
Gallery Hans Sandgren Jakobsen		331

Complements

COLLECTION	PAGE
Hydro & Locus Sofie Østerby	332
	
JG Folding Stool Jørgen Gammelgaard	337
	
Magazine Table Jens Risom	338
	
Nara Shin Azumi	339
	
Pioneer Maria Bruun	340
	
Seto Stool Keiji Takeuchi	341
	
Sequoia Space Copenhagen	342
	
Silhouette OEO Studio	343
	

Wood surfaces

Material and surface may refer to both solid wood and outer layer on plywood or veneered table tops. Oak, ash and beech are sourced from sustainably managed European forests. Walnut is American walnut. Not all products are available in all materials.



FSC® Licence number
FSC C151292

WOOD	FINISH	DESCRIPTION
Oak	Oak soap	Treated with natural soap flakes. Light colour gets patina and darkens over time
	Oak lacquered	Clear lacquer, slightly white pigmented
	Oak oil	Clear natural oil with darkening effect on the natural colour tone of oak
	Oak light oil	Clear natural oil slightly pigmented, preserving the natural light colour tone of oak.
	Smoked oak, oiled	Fumed oak with clear natural oil treatment. Brown colour tone where large colour differences occur between wooden parts. The dark colour lightens with sunlight.
	Smoked oak stained, lacquered	Stained in smoked oak colour and finished with matt lacquer. The natural surface of the wood is visible through the stain.
	Grey oak stained, lacquered / Light grey oak stained, lacquered	Stained in a dark grey/ light grey shade and finished with matt lacquer. The natural surface of the wood is visible through the stain.
	Oak black lacquered	Finished with black lacquer preserving wooden grain structure.
	Oak white painted	Painted white preserving wooden grain structure.
Ash	Ash oil	Clear natural oil with darkening effect on the natural colour tone of oak.
	Ash brown stained	Stained in dark colour. The natural surface of the wood is visible through the stain.
	White ash	Painted white preserving wooden grain structure
	Black ash	Finished with black lacquer preserving wooden grain structure
Beech	Beech soap	Treated with natural soap flakes, light colour gets patina and darkens over time.
	Beech lacquered	Clear lacquer
	Beech vintage lacquered	Finished with a slightly brown pigmented lacquer, darkening the surface of the wood.
	Beech standard lacquered colours	Finished with a coloured lacquer which limits the visibility of the wooden grain structure. Only available for Trinidad and J39. The specific colours can be seen under each product.
	Beech Black lacquered	Finished with black lacquer limiting the visibility of the wooden grain structure
	Beech white painted	Painted white, limiting the visibility of the wooden grain structure
Walnut	Walnut lacquered	Clear lacquer with UV protection
	Walnut oiled	Clear natural oil
Oregon Pine Laminate & linoleum	Oregon Pine lacquered	Finished with a slightly brown pigmented lacquer, darkening the surface of the wood.

Not all models are available in all colours.
Customised finishes are available, subject to quotation.

MATERIAL	COLOUR CODE	PATO TABLE	ANA	JG TABLE	PLAN TABLE
Nano laminat, white	Fenix 0032		•		
Nano laminat, black	Fenix 0720		•		•
Nano laminat, almond	Fenix 0717		•		
Linoleum, black				•	
Linoleum, grey				•	
Laminat, black		•			•
Really, Cotton Cream					•

For a visual overview of all our materials please see our material and surface catalogue *Fredericia Colour World* at fredericia.com

Material information

Standard Colours

The Standard Colours are applied to coloured-through recycled polypropylene (PP) and certain woods, as well as powder coats. Customised colours are available for an extra charge. Customer approval of the test is required before production start-up.

COLOUR NAME	COLOUR CODE	J39 MOGENSEN CHAIR	TRINIDAD	LYNDERUP	PLAN CHAIR & TABLE	PATO
Black	RAL 9005	•	•	•	•	•
White	RAL 9016	•				•
Dark grey	NCS S 8000 N					•
Stone	NCS S 3502 B					•
Sand	NCS S 2005 Y30R					•
Quartz grey	RAL 7039					•
Storm	NCS S 5020 R90B					•
Ancient green	NCS S 8010 B50G					•
Ocean	NCS S 3010 B90G					•
Dark red	NCS S 5540 Y90R					•
Modernist green	NCS S 5020-G30Y				•	
Bordeaux	NCS S 7020-R10B				•	
Heritage red	NCS S 4550-Y60R	•				
Indigo blue	RAL 5011	•				
Khaki green	NCS S 7010-G70Y	•	•			
Pebble grey	NCS S 3005-Y50R	•				
Deep red	NCS S7020-R			•		
Nordic blue	NCS S 3005-Y50R		•			

Metal Surfaces

Not all models are available in all colours. Customised finishes are available, subject to quotation.

NAME	DESCRIPTION
Brushed stainless steel	Stainless steel, brushed finish. Appearance match other brushed finishes.
Brushed chrome	Brushed, then chromed steel. Appearance match other brushed finishes.
Brushed aluminium	Aluminium with brushed finish. Appearance match other brushed finishes.
Chrome	Chrome plated (chrom III), occasionally in combination with polished aluminium.
Polished aluminium	Shiny polished aluminium. Appearance match chrome finish.
Matt chrome	Chrome plated (Chrom III), satin chromed.
Black	Powder coated RAL 9005.
Flint	Powder coating with metallic effect, gunmetal colour.

Stone

Marble and limestone are natural materials where two surfaces are never alike. The stones can contain sediments from fossils, sand holes, glass veins and porosity and all are indicators of genuine stone while attributing to the natural character of the surface. By quotation all stone can be delivered with polyester coating which seals the surface. Not all models are available in all surfaces. Marble is not flexible and won't respond well to heavy loading. Never sit or stand on your marble tabletop and avoid placing particularly heavy items on it. Max load is 20 kgs.

NAME	DESCRIPTION
Grey Pietra Marble	Grey Pietra is a marble with a matt, grey surface with natural, irregular flecks of white. The grey colour of the background can appear uniform but the nuances of grey can vary. The fine white streaks and slightly darker grey glazes give the surface an animated and elegant look. Grey Pietra is sourced from Turkey.
Black Marquina Marble	Black Marquina is an elegant marble with a matt, black surface with natural strong white veins. The intense marble takes its name from the quarries around the town of Marquina from which it is extracted. The irregular white veins can vary considerably from batch to batch. Black Marquina is sourced from Spain.

Fredericia Standard Fabrics

White Carrara Marble	White Carrara is a classic white marble with a matt surface, characterised by the occurrence of natural and irregular grey veins. White Carrara has been used for centuries by architects, designers and artists alike. The white surface can vary in tone and the occurrence of grey to almost black veins can likewise vary in quantity and strength. White Carrara is sourced from Italy.
Dark Atlantico Limestone	Dark Atlantico is a limestone with a beautiful natural surface and warm colour tones in umbra grey shades. Possible aspects of fossils and sediments. Large colour differences to be expected. Extremely sensitive to acids, which can leave non-removable marks. Dark Atlantico is sourced from Portugal.
Ivory Quartzite	Ivory Quartzite is a light and elegant stone with a matt ivory surface. The nuances can vary including the possibility of both light and darker veining. Resistant to acids and scratching. Ivory Quartzite is sourced from Brazil.
Tundra Grey Marble	Tundra Grey Marble is an exquisite natural stone with a unique blend of cloud-like grey hues and pearl tones. Its intricate veining patterns create a mesmerizing visual effect with a fine-grained surface which is smooth to the touch. Tundra grey is sourced from Turkey.

Fredericia Standard Fabrics

The Fredericia Standard Fabrics are a range of state-of-the-art upholstery fabrics recommended for the Fredericia product range. Textiles can be supplied in flame-retardant qualities that meet the requirements of the British Standard (BS) and California Technical Bulletin (CAL 117) fire safety law. For extended range of graded-in textile options and COM procedure please see page 18

*ATTENTION: Velour can have press marks (where pile naps have tendency to lay down) either from transport or in use. This is a typical property of velour and it is not to be seen as a defect.

NAME	COMPOSITION	MARTINDALE	ENVIRONMENTAL	FABRIC GROUP	BRAND
Connect	48% WO / 41% recycled PL / 9% PA / 2% virgin PL	90.000	EU Ecolabel	0	Gabriel
Bardal	70% WO / 30% VI	62.000	EU Ecolabel	1	Gudbrandsdalens Uldvarefabrik
Capture	85% WO / 15% PA	+100.000	EU Ecolabel	1	Gabriel
Grand Linen	100% LI	30.0000	Oeko-Tex 100	1	Fredericia / Libeco
Linara	63% CO / 37% LI	36.000	Oeko-Tex 100	1	Romo
Natural linen	91% / LI / 9% PA	28.000	Oeko-Tex 100	1	Fredericia / Libeco
Remix	90% WO / 10% PA	+100.000	EU Ecolabel	1	Kvadrat
Re-wool	45% WO (45% recycled WO) / 10% PA	100.000	EU Ecolabel	1	Kvadrat
Ruskin	70% VI / 15% LI / 10% WO / 5% PA	60.000		1	Romo
Barnum	45% CO / 19% VI / 15% WO / 13% PC / 8% PA	60.000	Oeko-Tex 100	2	Nevotex
Clay	76% LI / 21% CO / 3% PL	45.000	Greenguard Gold	2	Sahoo (Kvadrat)
Fiord	92% WO / 8% PA	60.000	EU Ecolabel	2	Kvadrat
Foss	76% WO / 11% VI / 8% PA / 5% LI	100.000	EU Ecolabel	2	Kvadrat
Hallingdal	70% WO / 30 % VI	+100.000	EU Ecolabel	2	Kvadrat
Harald*	100% CO	+100.000	Greenguard Gold	2	Kvadrat
Loop	46% PAN / 23% WO / 15% CO / 12% PA / 4% PL	60.000		2	Kirkby Design (Romo)
Savoy*	100% Trevira CS	+100.000	EU Ecolabel	2	Gabriel
Steelcut trio	90% WO / 10% PA	+100.000	EU Ecolabel	2	Kvadrat
Sunniva	58% WO / 25% VI / 8% LI / 5% PA / 4% PL	50.000	Greenguard Gold	2	Kvadrat
Cotil 863	54% WO / 44% CO	30.000		3	Cotil
Divina Melange	100% WO	45.000	EU Ecolabel	3	Kvadrat
Elle	25% CO / 20% VI / 20% WO / 20% PC / 15% PA	70.000	Greenguard	3	Sahoo (Kvadrat)
Vidar	94% WO / 6% PA	+100.000	EU Ecolabel	3	Kvadrat
Grand mohair*	100% Mohair (cotton base)	+100.000	Oeko-Tex 100	4	Danish Art Weaving
Safire	43% VI / 17% PAN / 15% WO / 9% CO / 8% PL / 8% LI	+100.000	Greenguard	4	Kvadrat Raf Simons
Sisu	99% WO / 1% PL	70.000	Greenguard Gold	4	Kvadrat
Gentle	60% WO / 20% PA / 20%PL	90.000	Greenguard Gold	5	Kvadrat Feabrik

Graded-in fabric

Fredericia Graded-In Fabrics shows numerous fabric options graded into the Fredericia price group structure and therefore surpass C.O.M procedure. Not all fabrics shown are suitable for all products, and Fredericia reserves the right to reject certain combinations of fabric and furniture. For sample swatches please refer to the suppliers.

	FABRIC GROUP 1	FABRIC GROUP 2	FABRIC GROUP 3	FABRIC GROUP 4	FABRIC GROUP 5
Kvadrat	Atlas	Canvas	Divina	Savanna	Aaren
		Haku	Divina MD		Atrium
		Maple	Forrest Nap		Byram
		Melange Nap	Hero/Hero Heather		Coda
		Patio	Jaali		Fuse
		Sport	Technicolour Fleck		Helia
		Steelcut	Tonica		Phlox
			Tonus		Reflex
Sahco			Keiga	Acca/Acca Stripe	Baru
				Balboa	Fanello
				Ecriture	Nara
				Moss	
				Tablu	
			Zero		
Gabriel	Blend	Breeze Fusion	Comfort+	EJ Savak	
	Cyber	Crisp	Savak		
	Grain	Mood			
	Passion	Select			
	Renewed loop				
Romo		Osumi	Fibre	Teddy	
		Soho	Fleck eco	Tosca	
			Smooth		
			Spiral		
Gudbrandsdalen		Amdal	Koksdal	Hemsedal	
		Mandal			
		Morgedal/Herringdal			
		Redal			
Dedar			Adamo & Eva	Sinequanon	Karakorum
			Loop Loop	Twillman	Nimbus
			Volez Vous		
Camira	Blazer	Yoredale	Craggan Flax		
	Main Line Flax				
Maharam	Meld	Merit	Tempo	Beck	Range
		Mode		Luce	Terra
Jab		City Velvet			
Neotex	Erik	Barnum		Regent	
	Megan				
	Njord				
Yarn Collective		Albee		Ismay	Burt
		Molly			Doré

Fredericia Leather

From surface finish to colour range, the leathers in the Fredericia Leather Collection are fine-tuned to complement the product range, both visually and in material tactility. The tanning processes are kept in enclosed systems to minimise local water pollution and environmental impact. All leathers are tanned in Italy or Sweden. Each partner tannery is monitored and supervised to secure Fredericia's ethical and quality standards.

NAME	COLOURS	TYPE	ENVIRONMENTAL	DESCRIPTION	LEATHER GROUP
Vice	11 Black	Pigmented Corrected grain 1,2-1,4 mm	European hides Chrome III tanned in Italy Blau e Engel Ecolabel	The leather surface is corrected with an even grain pattern embossment. Vice is an extremely durable leather. Reduced breathability.	0
Omni	112 Warm grey 293 Burnt sienna 301 Black 307 Cognac 320 Dark clay 377 Dark brown	Semi-aniline, Full grain 1,2-1,4 mm	European hides Chrome III tanned in Italy Blau e Engel Ecolabel	Elegant leather with harmonuous and regular full grain structure and a comfortable touch. User friendly with good protection against dirt and light, while being durable. All Omni colours are available as CRIB5 with pricing in Leather group 2 Omni 301, 307 & 377 available with SPOOR traceability no. verifying the origin of the raw with pricing in Leather group 2	1 (w/ CRIB5: 2) (w/ SPOOR: 2)
Primo	74 Umbra grey 75 Cognac 86-1 Dark brown 88 Black	Semi-aniline Full grain 1,5-1,7 mm	European hides Chrome III tanned in Italy Blau e Engel Ecolabel	Classic full-grain semi-aniline leather made from the best bull hides. A precise protective layer gives a comfortable touch with good breathability, while adding resistance to dirt.	2
Trace	8146 Olive 8175 Black 8680 Heritage brown 8870 Light tan	Semi-aniline Full grain 1,2-1,4 mm	Danish & Swedish hides Processed in Denmark, tanned in Germany. Chrome free Biodegradable & compostable	Trace is a semi-aniline leather developed specifically for Fredericia in Collaboration with Spoor, where the hides are traceable down to the specific animal. The leather is elegant with a rich depth in colour. Comes from the finest sorting of hides limited to Denmark and Sweden.	2
Max	91 Nutshell 92 Tan 93 Indian red 95 Cognac 96 Dark brown 98 Black	Aniline Full grain 1,2-1,4 mm	European hides Chrome III + vegetable tanned in Italy Blau e Engel Ecolabel	Luxurious aniline leather with a natural open-pored texture, made from the absolute top selection bull hides. The leather is highly breathable and comfortable with a smooth surface and tight structure. Max 95 & 98 available with SPOOR traceability no. verifying the origin of the raw with pricing in Leather group 4.	3 (w/ SPOOR: 4)
Cera	905 Russet brown	Aniline Full grain 1,1-1,3 mm	European hides Chrome III tanned in Italy Blau e Engel Ecolabel	A luxurious full-grain aniline leather which has been finished with a light wax resulting in a smooth surface with a silky feel. An open-pored leather that is highly breathable with a tight and elegant structure. Cera is made from the absolute top selection bull hides primarily from Norway and Switzerland.	4
Vegeta	90 Natural	Aniline (uncoloured) Full grain 1,2-1,4 mm	European hides Vegetable tanned in Italy Blau e Engel Ecolabel	Produced from the absolute top selection of hides. Vegeta has a natural open-pored texture, making the leather highly breathable. The leather acquires a unique patina and darkens over time.	4
Organic	906 Mocca	Semi-aniline Full grain 1,1-1,3 mm	Scandinavian hides Vegetable tanned in Sweden Organic content certified	Visible marks and variation in the surface coming from a free-ranging animal life is to be expected. Raw hides are traceable to certified organic cattle.	4
Nubuck	501 Light sand 502 Warm grey 506 Anthracite 512 Olive	Nubuck Sanded full grain 1,2-1,5 mm	European hides Chrome III tanned in Italy Blau e Engel Ecolabel	A full-grain aniline hide has been lightly sanded to obtain an exclusive matte effect. Tanning includes Scotchguard protection.	4

Graded-in leathers

Fredericia Graded-In Leathers show numerous leather options graded into the Fredericia price group structure. Not all leathers shown are suitable for all products, and Fredericia reserves the right to reject certain combinations of leather and furniture.

For sample swatches please refer to the suppliers.

	LEATHER GROUP 1	LEATHER GROUP 2	LEATHER GROUP 3	LEATHER GROUP 4	LEATHER GROUP 5
Former Erik Jørgensen Leathers	Cava (Colour 1 Black)	Apache	Corona		
Stolz (minimum pcs = 5 m2)		Select	Cervo	Velvet	
		Atlas		Vegetal	
Sørensen (minimum pcs = 5 m2)	Ultra crib 5	Triumph crib 5	Dunes	Terra	Elegance
	Optimo	Spectrum			
	Nuance	Flux			

A leather card of selected Sørensen Leathers can be ordered through Fredericia Customer Care.

We are here to help you

Customer Care & Aftersales

Mon–Thu: 08.00–16.00
Fri: 08.00–15.30

customerservice@fredericia.com
+45 7592 3344

Essential Assortment

Our Essential Assortment is a curated selection of our products which has been pre-configured from our general pricelist. The entire assortment will be available with all required metadata, making it suitable for e-commerce. Our Essential Assortment will be supported thoroughly by image material and have a consistent delivery time.

Customers Own Materials

Fredericia offers to upholster in custom-specific fabric and leather (C.O.M), after approval from Fredericia's quality department. For fabric and leather not included in Fredericia's standard Fabrics and Graded-in programmes we require a sample of at least 30x30cm. The physical sample and materials should be sent to Fredericia with the Fredericia C.O.M. forms attached.

C.O.M. sample form:
<http://www.fredericia.com/general/COMsampleform.pdf>

C.O.M. material form:
<http://www.fredericia.com/generaUCOMmaterialform.pdf>

The forms are also available through customer care & aftersales at customerservice@fredericia.com

Please be aware that if Fredericia receives materials and samples with insufficient information, delivery times will be affected.

Address:
Fredericia Furniture A/S
Treldevej 183
Gate 2
DK-7000 Fredericia

Table size seating overview



























MODEL	PRODUCT	SIZE (CM)	TABLE HEIGHTS AVAILABLE	SEATS (PATO)
6624	Plan Table	70 x 60	Dining, counter and bar height	
6627	Plan Table	Ø72	Dining, counter and bar height	
6629	Plan Table	Ø90	Dining, counter and bar height	
6631	Plan Table Fixed	200 x 100	Dining, counter and bar height	
6632	Plan Table Extendable	200/260 x 100	Dining height	
667B	Plan Table, Configuration B	120 x 260	Dining, counter and bar height	
667D	Plan Table, Configuration D	120 x 320	Dining, counter and bar height	
667F	Plan Table, Configuration F	120 x 380	Dining, counter and bar height	
667H	Plan Table, Configuration H	120 x 440	Dining, counter and bar height	

Table size seating overview

MODEL	PRODUCT	SIZE (CM)		SEATS (J39)
6292	Mogensen C18 Table	160 x 80	Shaker-style frame allows for any chair width	
6290	Mogensen C18 Table	180 x 90	Shaker-style frame allows for any chair width	
6293	Mogensen C18 Table	220 x 90	Shaker-style frame allows for any chair width	
6284	Mogensen 6284 Table	180 x 90		
6286	Mogensen 6286 Table	195 x 97,5	Shaker-style frame allows for any chair width	
6386	Mogensen 6386 Table	245 x 97,5	Shaker-style frame allows for any chair width	
6106	Taro	220 x 93,5		
6119	Taro	Ø90		
6121	Taro	Ø120		
6438	Post Table	225 x 100		
6440	Post Table	265 x 100		
6441	Post Table	270 x 100		
6442	Post Table	320 x 100		
6490	Ana	220 x 95 Forlænget: 320 x 95		 
6491	Ana	180 x 95 Forlænget: 280 x 95		 

Terms and conditions of sale and delivery for Fredericia Furniture A/S

Sale and claim process

Our Customer Care team is ready to assist you with the ordering and claim process.

Offer

You can request an offer by sending an e-mail to our Customer Care team at the following e-mail address: quote@fredericia.com

Any offer is made subject to errors, omissions and other inconsistencies, including misspellings. The stated dates of delivery are indicative only, as Fredericia reserves the right to change the dates of delivery in the final order confirmation.

Offers are binding for Fredericia for 60 days from the date of the offer, unless the price list is updated with new prices within 60 days from the date of the offer, or unless another deadline is expressly stated in the offer.

How to place an order

You can place an order by emailing our Customer Care team via the following email address: salesorder@fredericia.com

Please make sure your order is correct and includes all the information needed to process it, such as quantity/size/color/legs/gliders etc. Please also use the correct product name as stated in our pricelist.

Receiving the order confirmation

You will receive the order confirmation as soon as the order has been entered into our system. You can usually expect to receive this confirmation within 48 hours from sending the order.

Please always check the order confirmation as soon as possible after receiving it and contact us immediately if you find any discrepancies.

Changes or cancellations of orders

In general, we advise to keep cancellations to a minimum, but if changes or cancellations are needed, following rules apply.

- Changes to orders later than three working days after receipt of the order confirmation may affect both delivery and price, and a surcharge of EUR 40 / DKK 300 / SEK 420 / NOK 420 will be charged.
- If an order is canceled later than three days after the order confirmation, a fee of at least 10 % of the order amount will be charged. In addition, if customer-specific materials have been ordered and confirmed, an amount corresponding to the cost of this will be charged.

Returns

Returns are generally not accepted.

If you wish to return products, this can only be done with prior written agreement with Fredericia.

Terms of delivery

Please find the expected week of dispatch in your order confirmation.

If your order is delayed for various reasons, we will inform you of the new expected delivery week whenever possible.

If the delay exceeds 3 months and is not due to force majeure, you have the right to cancel the order. If a confirmed shipment is postponed at the customer's request, Fredericia reserves the right to invoice the total order amount on the originally agreed shipment date.

Fredericia cannot be held responsible for delivery issues or delays due to force majeure.

Requests for non-standard fabric 'Graded-in, COM and COL'

Graded-in fabric

We offer a large selection of fabrics and leathers in our standard fabric program which are listed in the pricelist. These have been carefully selected by the Fredericia design team.

In addition, we offer a wider range of graded-in fabrics for upholstery. If graded-in fabrics are requested, we will inform you whether a specific fabric is suitable for the requested design and cost. Please contact our Customer Care.

COM fabrics and COL leather

Fredericia offers upholstery in customer-specific fabric and leather (COM and COL), after approval by Fredericia quality department. For textiles and leather that do not appear in Fredericia's standard or Graded-in program, we require a sample of at least 30 x 30 cm for testing, to determine whether the fabric is suitable for the design.

To proceed with COM fabric or leather, please send your request to our Customer Care team via customerservice@fredericia.com

Materials sent to Fredericia are delivered as "DDP - delivered duty paid". Fredericia reserves the right to change the delivery time and charge a fee if the material is not delivered as described above. Please note that customs and other expenses in connection with sending material samples are for the customer's own account.

Product range

Fredericia has the right to cease production of certain products without notice.

Dimensions and tolerances

The stated dimensions are indicative and may vary, and deviations from a product's stated dimensions may occur. Any color or wood samples must be considered indicative. Fredericia cannot be held responsible for any differences between samples and the delivered products, and small variations in colors or wood materials may occur in large orders, as the products change naturally over time. Such variations are not considered manufacturing defects.

Reservation of ownership

Fredericia reserves, with the limitations resulting from inalienable legal rules, ownership of the sold item until the entire purchase price plus accrued costs has been paid to Fredericia.

Claims

We are dedicated to processing your claim efficiently, and we strive to respond as soon as possible. We kindly ask you to register your claim as soon as you find a defect in your product.

Please send your claim to service@fredericia.com including information as, pictures, item description, order number, dimensions, defect description, pictures of any visible stamps on the product etc. It is possible to fill in a claim form via below link, to secure all necessary information included in the inquiry.

<https://fredericia.com/da-DK/professionals#/gallery/Claims>

If the claim is accepted, Customer Care places an order for a new product or remedy the defect, by ordering a spare part or securing a repair.

Replacement orders or spare parts are only delivered to the same delivery address as the original order. Costs in connection with delivery or installation at the end customer are not covered by Fredericia. Cost for delivering a replacement or sparepart to the original address is covered by Fredericia. We will inform you whether you should return the defective product.

Product liability

Fredericia is liable if a delivered product causes personal injury or causes damage to property, if the object in question is, by its nature, usually intended for commercial use and is mainly used by the injured party accordingly.

Fredericia is not responsible for damage to commercial property, unless it is documented that the damage is due to errors on Fredericia's part that should not have been prevented by the Buyer's examination of the delivered products.

If a third party makes a claim for compensation for product liability against the Buyer, the Buyer must immediately notify Fredericia in writing.

Limitation of liability

Fredericia's liability is in all respects limited to the following.

Fredericia assumes no liability for losses caused by delay, defects or other non-compliance, unless the loss is caused by gross negligence on Fredericia's part.

Fredericia assumes no responsibility for indirect losses, including loss of goodwill, lost profits (e.g. loss of profit), operating losses, running costs or loss of clientele.

Fredericia's liability for damages in relation to a single order is in all cases limited to the value of the order in question calculated as the total purchase price excluding VAT.

- If the product has been abused, misused, or cleaned using wrong cleaning methods
- Damage due to normal wear and tear
- If the product has been placed outdoors or in a humid environment
- If the product has been exposed to prolonged strong sunlight or heat.
- If a product deviates from a sample of wood or fabric. As the material matures naturally over a period, samples can only be considered as a guiding
- Cane wicker is excepted from the extended warranty, and a two-year warranty is provided.

Products manufactured according to customer specifications are not covered by Fredericia's test certificates regarding strength, durability and stability, and Fredericia therefore gives no warranty in this regard.

The original purchase invoice is mandatory when a claim is made under the extended warranty.

Replaced products or replaced product parts shall become the property of Fredericia. Delivery of a replacement product or repair of a product does not result in a renewal or extension of the applicable warranty period.

Any inquiries or questions related to this warranty should be directed to our Customer Care department.

Warranty

Extended product warranty

Fredericia offers an extended warranty against production and construction defects. The warranty covers faults which were present at the time of purchase, or which have arisen due to faults which were present at the time of purchase. The warranty period is calculated from the date of the original invoice. During the applicable warranty period, Fredericia will, at its sole obligation and its sole discretion, either repair, replace or issue a credit note regarding the defective product, the defective part or the defective components.

Extended product warranty applies from products purchased after 1st of January 2023.

25-year warranty

A 25-year warranty is provided on selected models:

- The Spanish Chair (2226)
- OX og Queen Chair (1000/1010)
- Corona Chair (5000)
- BM 22 collection by Børge Mogensen

10-year warranty

A 10-year warranty is provided on sofas.

7-year warranty

A 7-year warranty is provided on armchairs, chairs, tables, coffee tables and smaller pieces of furniture under our Complements collection (e.g. side tables).

2-year warranty

A 2-year warranty is provided on lamps and accessories, including vases and loose spare parts.

The warranty does not apply in the following situations (the list is non-exhaustive):

- COM – customer leather, customer fabrics or material ordered separately
- In cases of consequential or incidental damage
- If the product has been stored, assembled, or maintained wrongly
- In the attempt of a failed repair or modification of the product without Fredericia's consent.

Transport

Standard delivery

Delivery of goods from Fredericia is deemed to have occurred when the customer has received the goods. Standard delivery will be made to the same country as the invoicing address. All orders are shipped with the best suitable carrier and week of dispatch is indicated on your order confirmation. The stated delivery date is indicative and may therefore be waived. Standard delivery addresses cannot be located in a country different from the country of the invoicing address.

Non-standard delivery address

For orders above a high minimum order value, we are able to deliver to a non-standard delivery address. If a non-standard delivery address is requested, your Customer Care representative will send you a form to be filled out with details. Any changes to the sales order or delivery booking cannot be made before the form has been returned.

Any request for delivery to a non-standard delivery address, may be charged with a special delivery surcharge calculated on a case by case basis.

Any special requirements on delivery, ex. use of lorry with a tail lift etc. may be charged with a special delivery surcharge calculated on a case by case basis.

Please check the delivery surcharges with our Customer Care.

Change of delivery address

- Changes to delivery address can be made up until two weeks before confirmed dispatch week, however changes will be charged a fee of EUR 40 / DKK 300 / SEK 420 / NOK 420.
- Changes to delivery address less than two weeks before confirmed dispatch week, will be charged a fee of EUR 100 / DKK 750 / SEK 1.050 / NOK 1.050.
- Changes to delivery address after the order has left our warehouse, an extra fee will be added depending on the status of the delivery.

Please contact your Customer Care representative in all cases.

Fix delivery / delivery of low amount orders

Please inform your Customer Care representative if you need a fixed date or time for your order, so that we can include this in your order confirmation.

Fixed delivery on a specific date, will be charged an extra fee of EUR 100 EUR / DKK 750 / SEK 1.050 / NOK 1.050.

Fixed delivery on a specific timeslot, will be charged an extra fee of EUR 100 EUR / DKK 750 / SEK 1.050 / NOK 1.050.

We reserve the right to change confirmed date and time of delivery due to force majeure.

For the delivery of smaller orders with a value below EUR 700 / DKK 5,200 / SEK 7,000 / NOK 7,000, including the shipment of spare parts unrelated to a complaint, a separate shipping surcharge of EUR 10 / DKK 75 / SEK 110 / NOK 110 will be applied.

Standard delivery conditions

Standard delivery conditions to addresses located within Europe is either "DAP – Delivered At Place" or "DDP – Delivered Duty Paid", unless stated otherwise on your order.

Standard delivery conditions to addresses located outside Europe is "EXW – Ex Works", unless stated otherwise on your order.

For specific information about your delivery conditions, please see your order confirmation or contact our Logistics department.

Transport damages and missing products

Upon delivery, it is your responsibility to check the delivery for visible damages. If the delivery does not comply with your expectations, reservations should be made on the delivery note and expressly noted to the carrier immediately on the CMR document. The note must

include a clear and detailed description of whether the products are damaged, wet etc. For documentation purposes, please make sure to take pictures of the damaged pallets, packaging or products right after delivery and forward them according to our claim procedure.

Missing products should be noted on the delivery note and CMR document. Please contact our Customer Care immediately after delivery and confirmation of missing products. We will investigate the missing delivery in our supply chain and logistics. If no proper documentation and pictures is provided and the claim is not received within 72 hours of receipt of the goods, Fredericia is not obligated to accept the claim.

Non-visible damage

If there are no visible damages to the exterior of the packaging or the products upon receipt, but visible damages to the products are discovered after the opening of the packaging, it must be reported to us in writing. You are required to take photographs of the product and the packaging and submit them to us along with a written report as soon as they are discovered, and no later than 7 days after receipt.

Payment

Any questions to making payments, our accounting department is always at your service to assist. Our accounting department can be contacted on economy@fredericia.com.

Payment information

All payments must be made using bank transfer to Fredericia's account at the Buyer's expense, unless another payment method is agreed in writing. The payment information for bank transfers, such as the IBAN number and SWIFT code, can be found on your sales order or -invoice.

For sales invoices:

- Please refer to the invoice number in the payment description. It is possible to combine payments for several invoices in one transfer. All invoices paid must be referenced in the payment description.

For sales orders (prepayment / payment-before-production):

- Please refer to the sales order number (SO123456) in the payment description. If missing payment description with proper referencing, Fredericia reserve the right to change the confirmed date and time of delivery on your expense.

Debtor policy

New customers at Fredericia are obliged to make a prepayment on the first three orders. Please note that the prepayment must happen before initiating the production of the submitted order. Credit assessment may be requested for subsequent orders. For customers with a credit limit, this can be disclosed by the sales- or customer service representative. If the credit limit for an account is reached, Fredericia requires previous invoices to be paid in full before new orders can be placed.

Invoices and prepayments of sales orders must be paid on time. If a due date is exceeded, payment reminders will be sent followed by debt collection and temporary closure of the account.

Fredericia has the right to impose interest of 2.0% per month started from the day after the due date and until full payment has been made. Fees for payment reminders are charged in accordance with applicable law.

Failure to make timely payment for an order will be considered a material breach. In the event of non-payment, Fredericia has the right to withhold all further deliveries to the customer. Fredericia assumes no responsibility as a result of withholding deliveries, regardless of whether such deliveries are interconnected.

Payment to Fredericia cannot be withheld on the basis that the product is defective, unless Fredericia has acknowledged the claim.

Reminders

- First reminder: five (5) days after due date
- Second reminder: ten (10) days after the first reminder was sent.
- Third reminder: ten (10) days after second reminder was sent. On third reminder, we inform you that your account has been suspended for further orders and will also include notification of debt collection.

Account suspension and reactivating account

For accounts that has been suspended, Fredericia will not process or deliver orders (confirmed/not confirmed) until the overdue amount has been paid.

Once the overdue amount has been paid, the account suspension will be revoked and confirmed orders will be processed and shipped as indicated on your order.

For accounts that has been suspended and reactivated, the general payment terms will be revoked, and the following three order must again be prepaid according to the debtor policy. Fredericia will decide if the general payment terms can be changed depending on your payment history.

Bank account information

Fredericia can receive payments using the following currency accounts depending on invoice/order currency. If payment is made to a below account that differs from its main currency, Fredericia reserve the right to add surcharges depending on the bank fees.

Always use the bank information provided on your sales invoice or -order.

CURRENCY	IBAN	SWIFT/BIC
DKK	DK8920000440300510	NDEADKKK
EUR	DK0320005005892335	NDEADKKK
NOK	NO7460210722087	NDEANOKK
SEK	SE3695000099601819659515	NDEASESS

CONTACT

Fredericia Furniture A/S
Treldevej 183
7000 Fredericia
customerservice@fredericia.com
www.fredericia.com

Chairs & Stools

Model 3261

BM61 Chair Cane wicker



Designed by Børge Mogensen, 1958

Chair in solid wood with seat and back in cane webbing. Mounted with interchangeable quick-click plastic glides. Separate felt glides included.

Modeldetails

0,25 m³ Packaging dimensions:
6 kg / 4,3 kg L: 55 cm W: 55 cm H: 82,5 cm

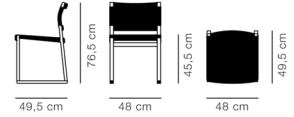

Essential Assortment

Item number	Wood	Seat and back	Price
32611024000	Oak lacquer	Cane wicker, natural	2.499

Order configuration

	Oak lacquered	Oak oiled
Natural cane wicker	2.499	2.577

Model 3361

BM61 Chair Linen webbing



Designed by Børge Mogensen, 1958

Chair in solid wood. Seat and backrest of linen webbing. Mounted with interchangeable quick-click plastic glides. Separate felt glides included.

Modeldetails

0,25 m³ Packaging dimensions:
5,4 kg / 4,4 kg L: 55 cm W: 55 cm H: 82,5 cm

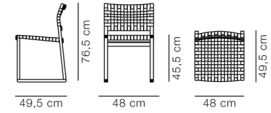

Essential Assortment

Item number	Wood	Seat and back	Price
33610063100	Oak black lacquered	Linen webbing black	1.124
33611023000	Oak lacquer	Linen webbing natural	1.224

Order configuration

	Oak black lacquered	Oak lacquered	Oak oiled
Natural webbing	1.159	1.224	1.324
Black webbing	1.124		

Certifications

EN 1022:2005, EN 16139:2013 (L2)

Model 3262

BM62 Armchair Cane wicker



Designed by Børge Mogensen, 1958

Armchair in solid wood with seat and back in cane webbing. Mounted with interchangeable quick-click plastic glides. Separate felt glides included.

Modeldetails

0,32 m³ Packaging dimensions:
7,3 kg / 5,1 kg L: 55 cm W: 67 cm H: 82,5 cm

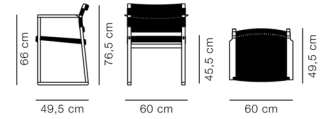

Essential Assortment

Item number	Wood	Seat and back	Price
32621024000	Oak lacquer	Cane wicker, natural	2.916

Order configuration

	Oak lacquered	Oak oiled
Natural cane wicker	2.916	3.025

Model 3362

BM62 Armchair Linen webbing



Designed by Børge Mogensen, 1958

Chair in solid wood. Seat and backrest of linen webbing. Mounted with interchangeable quick-click plastic glides. Separate felt glides included.

Modeldetails

0,3 m³ Packaging dimensions:
6,2 kg / 5,2 kg L: 55 cm W: 67 cm H: 82,5 cm

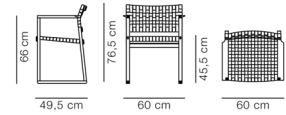

Essential Assortment

Item number	Wood	Seat and back	Price
33620063100	Oak black lacquered	Linen webbing black	1.266
33621023000	Oak lacquer	Linen webbing natural	1.433

Order configuration

	Oak black lacquered	Oak lacquered	Oak oiled
Natural webbing	1.317	1.433	1.463
Black webbing	1.266		

Certifications

EN 1022:2005, EN 16139:2013 (L2)

Model 4810

Eyes 4 Leg Chair Tube base



Designed by Foersom & Hiort-Lorenzen, 2007

Chair with shell in moulded cold cured foam reinforced with steel, fully upholstered in fabric or leather. Base of steel tube mounted with plastic glides. Felt glides available.

Modeldetails

0,4 m³ Packaging dimensions:
13 kg / 10 kg L: 68 cm W: 62 cm H: 96 cm

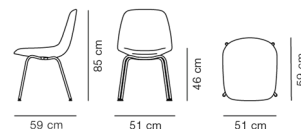

Essential Assortment

Item number	Upholstery	Frame	Price
4810193000006000503	Re-Wool 198	Black	749
48101931100006000503	Re-Wool 128	Black	749
48104452400006000603	Gentle 873	Brushed stainless steel	1.083

Essential variants are delivered with plastic glides and HR foam

Order configuration

	Black	Brushed stainless steel
Fabric group 0	714	714
Fabric group 1	768	768
Fabric group 2	846	846
Fabric group 3	883	883
Fabric group 4	995	995
Fabric group 5	1.194	1.194
C.O.M. fabric	768	768
Leather group 0	1.149	1.149
Leather group 1	1.235	1.235
Leather group 2	1.378	1.378
Leather group 3	1.599	1.599
Leather group 4	1.708	1.708
Leather group 5	1.965	1.965
C.O.M. leather	1.235	1.235

Fabric consumption: 1,2 m. Leather consumption: 2,5 m²

As standard delivered without decoration buttons.

Extra charge for

Buttons in the same upholstery as the chair or in selected leather: +103

Certifications

EN 1022:2005, EN 16139:2013 (L2)

Recommended upholstery

Fabric group 0	Connect
Fabric group 1	Capture, Re-wool, Remix, Bardal, Linara, Ruskin, Natural Linen, Erik
Fabric group 2	Hallingdal, Sunniva, Barnum, Fiord, Steelcut Trio, Foss, Loop, Clay
Fabric group 3	Vidar, Divina Melange, Elle, Cotil 863
Fabric group 4	Safire, Sisu
Fabric group 5	Gentle
Leather group 0	Vice
Leather group 1	Omni
Leather group 2	Primo, Trace
Leather group 3	Max
Leather group 4	Vegeta, Organic, Nubuck, Cera

Model 4830

Eyes 4 Leg Barstool



Designed by Foersom & Hiort-Lorenzen, 2007

Barstool with shell in moulded cold cured foam reinforced with steel, fully upholstered in fabric or leather. Base of steel tube mounted with plastic glides. Felt glides available. Please specify bar or counter height.

Modeldetails

0,55 m³ Packaging dimensions:
15 kg / 12 kg L: 65 cm W: 66 cm H: 129 cm

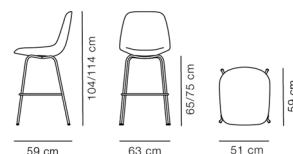

Essential Assortment

Item number	Upholstery	Frame	Price
4830193000006000523	Re-Wool 198	Black, 75 cm	999
48301931100006000523	Re-Wool 128	Black, 75 cm	999
48304452400006000623	Gentle 873	Brushed stainless steel, 75 cm	1.416

Essential variants are delivered with plastic glides and HR foam

Order configuration

Bar or counter height.

	Black	Brushed stainless steel
Fabric group 0	1.002	1.002
Fabric group 1	1.077	1.077
Fabric group 2	1.155	1.155
Fabric group 3	1.192	1.192
Fabric group 4	1.304	1.304
Fabric group 5	1.565	1.565
C.O.M. fabric	1.077	1.077
Leather group 0	1.436	1.436
Leather group 1	1.544	1.544
Leather group 2	1.687	1.687
Leather group 3	1.908	1.908
Leather group 4	2.017	2.017
Leather group 5	2.320	2.320
C.O.M. leather	1.544	1.544

Fabric consumption: 1,2 m. Leather consumption: 2,5 m²

As standard delivered without decoration buttons.

Extra charge for

Buttons in the same upholstery as the chair or in selected leather: +103

Certifications

EN 1022:2005, EN 16139:2013 (L1)

Recommended upholstery

Fabric group 0	Connect
Fabric group 1	Re-wool, Remix, Bardal, Capture, Ruskin, Linara, Natural Linen, Erik
Fabric group 2	Hallingdal, Sunniva, Barnum, Fiord, Steelcut Trio, Foss, Loop, Clay
Fabric group 3	Vidar, Divina Melange, Elle, Cotil 863
Fabric group 4	Safire, Sisu
Fabric group 5	Gentle
Leather group 0	Vice
Leather group 1	Omni
Leather group 2	Primo, Trace
Leather group 3	Max
Leather group 4	Vegeta, Organic, Nubuck, Cera

Model 4808

Eyes Cantilever Armchair



Designed by Foersom & Hiort-Lorenzen, 2007

Chair with shell in moulded cold cured foam reinforced with steel, fully upholstered in fabric or leather. Cantilever base in steel with leather armrests. Mounted with plastic glides.

Modeldetails

0,4 m³ Packaging dimensions:
13 kg / 10 kg L: 62 cm W: 68 cm H: 97 cm

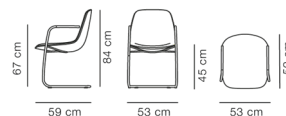

Essential Assortment

Item number	Upholstery	Frame	Price
4808193000006000550	Re-Wool 198	Black, arm with leather 98, black	1.191
48081931100006000550	Re-Wool 128	Black, arm with leather 98, black	1.191
48084452400006000640	Gentle 873	Mat chrome, arm leather 95 cognac	1.649

Essential variants are delivered with plastic glides and HR foam

Order configuration

Arm: Leather (90 natural, 95 cognac or 98 black).

	Black	Mat chrome
Fabric group 0	1.107	1.107
Fabric group 1	1.191	1.191
Fabric group 2	1.282	1.282
Fabric group 3	1.325	1.325
Fabric group 4	1.456	1.456
Fabric group 5	1.748	1.748
C.O.M. fabric	1.191	1.191
Leather group 0	1.616	1.616
Leather group 1	1.738	1.738
Leather group 2	1.905	1.905
Leather group 3	2.164	2.164
Leather group 4	2.292	2.292
Leather group 5	2.636	2.636
C.O.M. leather	1.738	1.738

Fabric consumption: 1,2 m. Leather consumption: 2,5 m²

As standard delivered without decoration buttons.

Extra charge for

Buttons in the same upholstery as the chair or in selected leather: +103

Recommended upholstery

Fabric group 0	Connect
Fabric group 1	Capture, Re-wool, Remix, Bardal, Linara, Ruskin, Natural Linen, Erik
Fabric group 2	Hallingdal, Sunniva, Barnum, Fiord, Steelcut Trio, Foss, Loop, Clay
Fabric group 3	Vidar, Divina Melange, Elle, Cotil 863
Fabric group 4	Safire, Sisu
Fabric group 5	Gentle
Leather group 0	Vice
Leather group 1	Omni
Leather group 2	Primo, Trace
Leather group 3	Max
Leather group 4	Vegeta, Organic, Nubuck, Cera

Model 4818

Eyes Swivel Chair Swivel base



Designed by Foersom & Hiort-Lorenzen, 2007

Chair with shell in moulded cold cured foam reinforced with steel, fully upholstered in fabric or leather. 4-point swivel base in aluminum. Mounted with plastic glides. Felt glides and castors available. The base is not height adjustable.

Modeldetails

0,4 m³ Packaging dimensions:
16 kg / L: 62 cm W: 68 cm H: 97 cm
13 kg

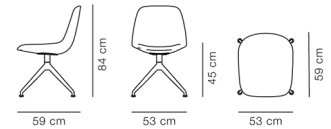

Order configuration

	Black	Polished aluminium
Fabric group 0	987	987
Fabric group 1	1.061	1.061
Fabric group 2	1.143	1.143
Fabric group 3	1.183	1.183
Fabric group 4	1.301	1.301
Fabric group 5	1.561	1.561
C.O.M. fabric	1.061	1.061
Leather group 0	1.446	1.446
Leather group 1	1.555	1.555
Leather group 2	1.705	1.705
Leather group 3	1.939	1.939
Leather group 4	2.055	2.055
Leather group 5	2.363	2.363
C.O.M. leather	1.555	1.555

Fabric consumption: 1,2 m. Leather consumption: 2,5 m²

As standard delivered without decoration buttons.

Extra charge for

Buttons in the same upholstery as the chair or in selected leather: +103
Castors: +26

Certifications

EN 1022:2005, EN 16139:2013 (L1)

Recommended upholstery

Fabric group 0	Connect
Fabric group 1	Capture, Re-wool, Remix, Bardal, Linara, Ruskin, Natural Linen, Erik
Fabric group 2	Hallingdal, Sunniva, Barnum, Fiord, Steelcut Trio, Foss, Loop, Clay
Fabric group 3	Vidar, Divina Melange, Elle, Cotil 863
Fabric group 4	Safire, Sisu
Fabric group 5	Gentle
Leather group 0	Vice
Leather group 1	Omni
Leather group 2	Primo, Trace
Leather group 3	Max
Leather group 4	Vegeta, Organic, Nubuck, Cera

Model 4820

Eyes Swivel Armchair Swivel base



Designed by Foersom & Hiort-Lorenzen, 2007

Chair with shell in moulded cold cured foam reinforced with steel, fully upholstered in fabric or leather. Armrests in stainless steel and leather. 4-point swivel base in aluminum. Mounted with reversible plastic glides which can be changed to felt when reversed. Castors available. The base is not height adjustable. The base is not height adjustable.

Modeldetails

0,4 m³ Packaging dimensions:
17 kg / 14 kg L: 62 cm W: 68 cm H: 97 cm

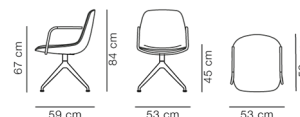

Order configuration

Arm: Leather (90 natural, 95 cognac or 98 black).

	Black	Polished aluminium
Fabric group 0	1.239	1.239
Fabric group 1	1.332	1.332
Fabric group 2	1.414	1.414
Fabric group 3	1.453	1.453
Fabric group 4	1.572	1.572
Fabric group 5	1.886	1.886
C.O.M. fabric	1.332	1.332
Leather group 0	1.698	1.698
Leather group 1	1.826	1.826
Leather group 2	1.976	1.976
Leather group 3	2.210	2.210
Leather group 4	2.326	2.326
Leather group 5	2.674	2.674
C.O.M. leather	1.826	1.826

Fabric consumption: 1,2 m. Leather consumption: 2,5 m²

As standard delivered without decoration buttons.

Extra charge for

Buttons in the same upholstery as the chair or in selected leather: +103
Castors: +26

Certifications

EN 1022:2005, EN 16139:2013 (L1)

Recommended upholstery

Fabric group 0	Connect
Fabric group 1	Capture, Re-wool, Remix, Bardal, Linara, Ruskin, Natural Linen, Erik
Fabric group 2	Hallingdal, Sunniva, Barnum, Fiord, Steelcut Trio, Foss, Loop, Clay
Fabric group 3	Vidar, Divina Melange, Elle, Cotil 863
Fabric group 4	Safire, Sisu
Fabric group 5	Gentle
Leather group 0	Vice
Leather group 1	Omni
Leather group 2	Primo, Trace
Leather group 3	Max
Leather group 4	Vegeta, Organic, Nubuck, Cera

Model 3381

Flamingo Chair Swivel base



Designed by Foersom & Hiort-Lorenzen, 2003

Swivel chair with shell in moulded cold cured foam reinforced with steel, fully upholstered in fabric or leather. Cover is non-removable. Swivel base of stainless steel tube, mounted with plastic glides. Natural fibre glides, as an alternative to felt.

Modeldetails

0,4 m³ Packaging dimensions:
18 kg / 15 kg L: 67 cm W: 61 cm H: 93 cm

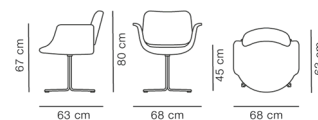

Essential Assortment

Item number	Upholstery	Frame	Price
338100219060140	Hallingdal 130	Brushed stainless steel	1.799
338150093060140	Leather Max 93, Indian red	Brushed stainless steel	2.699
338150095060140	Leather Max 95, Cognac	Brushed stainless steel	2.699
338150098060140	Leather Max 98, Black	Brushed stainless steel	2.699

Essential variants are delivered with plastic glides and HR foam

Order configuration

	Black	Brushed stainless steel
Fabric group 1	1.684	1.684
Fabric group 2	1.796	1.796
Fabric group 3	1.850	1.850
Fabric group 4	2.011	2.011
Fabric group 5	2.413	2.413
C.O.M. fabric	1.684	1.684
Leather group 0	2.196	2.196
Leather group 1	2.361	2.361
Leather group 2	2.592	2.592
Leather group 3	2.952	2.952
Leather group 4	3.130	3.130
Leather group 5	3.599	3.599
C.O.M. leather	2.361	2.361

Fabric consumption: 1,5 m. Leather consumption: 2,5 m²

Extra charge for

Glides with natural fibre: +24

Recommended upholstery

Fabric group 1	Remix, Capture, Bardal, Re-wool, Linara, Ruskin, Natural Linen, Erik
Fabric group 2	Hallingdal, Barnum, Loop, Steelcut Trio, Sunniva, Foss, Fiord, Clay
Fabric group 3	Divina Melange, Elle, Vidar
Fabric group 4	Grand Mohair, Sisu, Safire
Fabric group 5	Gentle
Leather group 0	Vice
Leather group 1	Omni
Leather group 2	Primo, Trace
Leather group 3	Max
Leather group 4	Nubuck, Vegeta, Organic, Cera

Model 3239

J39 Mogensen Chair



Designed by Børge Mogensen, 1947

Chair in solid wood with woven paper cord seat. Back in wood moulded in layers.

Modeldetails

0,28 m³ Packaging dimensions:
6,2 kg / 4,8 kg L: 53 cm W: 55 cm H: 101 cm

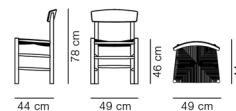

Essential Assortment

Item number	Seat	Wood	Price
32392172510	Natural paper cord	Beech black lacquer, FSC Mix 70%	433
32392202510	Natural paper cord	Beech vintage lacquer, FSC Mix 70%	433
32392802510	Natural paper cord	Beech khaki green, FSC Mix 70%	433
32392812510	Natural paper cord	Beech indigo blue, FSC Mix 70%	433
32392822510	Natural paper cord	Beech Heritage red, FSC Mix 70%	433
32392832510	Natural paper cord	Beech pebble grey, FSC Mix 70%	433
32392032510	Natural paper cord	Oak soap, FSC Mix 70%	683
32392052510	Natural paper cord	Oak oil, FSC Mix 70%	683
32392062510	Natural paper cord	Oak light oil, FSC Mix 70%	683
32392242610	Black paper cord	Oak black lacquer, FSC Mix 70%	766

Order configuration

	Oak black lacquered	Beech coloured lacquer	Beech soap	Oak soap	Oak oiled	Oak light oil	Walnut oiled
Seat natural paper cord	683	519	519	683	683	683	824
Seat black paper cord	766						

Beech coloured lacquer: Black, White, Indigo blue, Khaki green, Heritage red, Pebble grey, Vintage lacquered.

Extra charge for

QuickClick glides with or without felt (R3239): +24

Certifications

Oak is FSC® certified
Beech is FSC® certified
Nordic Swan Ecolabel
ANSI/BIFMA X5.4-2020

Model P3239

J39 Mogensen Chair Seat pad

Modeldetails



Designed by Fredericia Furniture, 2022

Seat cushion for J39 Mogensen chair. HR Foam with cover in Russet brown (cognac) aniline leather and backing in canvas. Produced from excess and scrap leather from own production in Denmark.

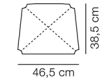

Order configuration

	Leather Cera Russet brown Unit price	Leather Cera Russet brown Total
1 pcs	125	125
12 pcs	123	1.480
24 pcs	118	2.820

Model 3207

Klint Chair



Designed by Kaare Klint, 1936

Chair with solid wood frame and a woven paper cord seat. Molded veneer back with core in the same wood as top veneer.

Modeldetails

0,24 m³ Packaging dimensions:
12 kg / 4,5 kg L: 57 cm W: 59 cm H: 87 cm

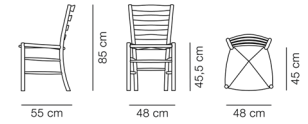

Essential Assortment

Item number	Seat	Wood	Price
32072242500	Natural paper cord	Oak black lacquer, FSC Mix 70%	705
32072032500	Natural paper cord	Oak soap, FSC Mix 70%	945
32072052500	Natural paper cord	Oak oil, FSC Mix 70%	945

Delivery from July 2024

Extra charge for

QuickClick glides with or without felt (R3207G): +24

Certifications

FSC® certified
EN 1022:2005, EN 16139:2013 (L1)

Model 3208



Klint Chair Armchair

Designed by Kaare Klint, 1936

Armchair with solid wood frame and a woven paper cord seat. Molded veneer back with core in the same wood as top veneer.

Modeldetails

0,3 m³ Packaging dimensions:
9 kg / L: 57 cm W: 61 cm H: 87 cm
5,5 kg

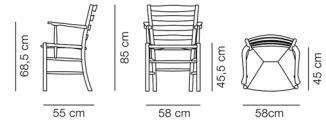

Essential Assortment

Item number	Seat	Wood	Price
32082242500	Natural paper cord	Oak black lacquer, FSC Mix 70%	825
32082032500	Natural paper cord	Oak soap, FSC Mix 70%	1.060
32082052500	Natural paper cord	Oak oil, FSC Mix 70%	1.060

Delivery from July 2024

Extra charge for

QuickClick glides with or without felt (R3207G): +24

Certifications

FSC® certified
EN 1022:2005, EN 16139:2013 (L1)

Model 3080

Lynderup Chair Wooden seat



Designed by Børge Mogensen, 1954

Stacking chair with steel frame. Interchangeable back and seat of plywood finished with water-based lacquer. Frame of powder coated or chromed tubular steel. Mounted with interchangeable Quick-click glides in plastic. Interchangeable glides in felt are included and delivered with each chair.

Modeldetails

0,41 m³ Packaging dimensions:
6,5 kg / L: 60 cm W: 71 cm H: 96 cm
5,5 kg

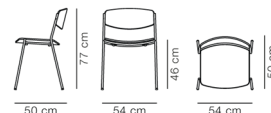

Essential Assortment

Item number	Wood	Frame	Price
30802231791075001	Black ash, FSC Mix 70%	Black lacquer	391
30802021791075001	Oak lacquer FSC Mix 70%	Black lacquer	466
30802281791075001	Ash deep red, FSC Mix 70%	Black lacquer	466
30802261791075001	Walnut lacquer, FSC Mix 70%	Black lacquer	483

Order configuration

	Oak lacquered	Black ash	Deep red ash	Walnut lacquered
Black	466	391	466	483
Chrome	469	407	469	489

Mounted with Quick-click glides in plastic. Interchangeable glides in felt are included and delivered with each chair.
Stackable: 20 pcs. on trolley, 12 pcs. on floor.

Certifications

EU Ecolabel
FSC® certified
EN 1022:2005, EN 16139:2013 (L1)

Model 3081

Lynderup Chair Seat upholstered



Designed by Børge Mogensen, 1954

Stacking chair with steel frame and upholstered seat. Interchangeable back finished with water-based lacquer. Plywood has beech core with ash, oak or walnut top veneer. Fully upholstered seat upholstered in CMHR or HR foam, covered in fabric or leather. Frame of powder coated or chromed tubular steel. Mounted with interchangeable quick-click plastic glides. Separate felt glides included.

Model details

0,41 m³ Packaging dimensions:
7,5 kg / 6,5 kg L: 60 cm W: 71 cm H: 96 cm

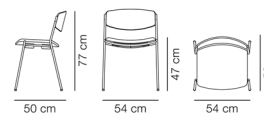

Essential Assortment

Item number	Upholstery	Wood	Frame	Price
30810130302231791075	Connect 60999	Black ash, FSC Mix 70%	Black lacquer	533
30810130102021791075	Connect 60147	Oak lacquer FSC Mix 70%	Black lacquer	558
30811930002231791075	Re-Wool 198	Black ash, FSC Mix 70%	Black lacquer	563
30810130302261791075	Connect 60999	Walnut lacquer, FSC Mix 70%	Black lacquer	574
30811931102021791075	Re-Wool 128	Oak lacquer FSC Mix 70%	Black lacquer	591
30815130102231791075	Leather Omni 301, Black	Black ash, FSC Mix 70%	Black lacquer	599
30811930002261791075	Re-Wool 198	Walnut lacquer, FSC Mix 70%	Black lacquer	608
30815130102021791075	Leather Omni 301, Black	Oak lacquer FSC Mix 70%	Black lacquer	608
30815130102261791075	Leather Omni 301, Black	Walnut lacquer, FSC Mix 70%	Black lacquer	649

Essential variants only delivered with HR foam

Order configuration

Frame: Chrome or black.

	Oak lacquered	Black ash	Deep red ash	Walnut lacquered
Fabric group 0	600	568	600	619
Fabric group 1	616	583	616	635
Fabric group 2	647	613	647	667
Fabric group 3	679	643	679	699
Fabric group 4	734	696	734	755
Fabric group 5	805	763	805	828
C.O.M. fabric	616	583	616	635
Leather group 0	612	580	612	632
Leather group 1	632	598	632	651
Leather group 2	661	627	661	682
Leather group 3	673	637	673	693
Leather group 4	703	666	703	723
Leather group 5	808	766	808	832
C.O.M. leather	632	598	632	651

Fabric consumption: 0,6 m. Leather consumption: 0,54 m²

Mounted with Quick-click glides in plastic. Interchangeable glides in felt are included and delivered with each chair.
Stackable: 15 pcs. on trolley, 8 pcs. on floor.

Certifications

EU Ecolabel variants: Chrome or black powder-coated frame together with black shell and upholstery in Omni leather 301 black, Connect, Remix or Re-wool fabric
FSC® certified

EN 1022:2005, EN 16139:2013 (L1)

Recommended upholstery

Fabric group 0	Connect
Fabric group 1	Grand Linen, Remix, Capture, Bardal, Re-wool, Linara, Ruskin, Natural Linen, Erik
Fabric group 2	Hallingdal, Barnum, Loop, Steelcut Trio, Sunniva, Harald, Foss, Fiord, Clay, Savoy
Fabric group 3	Divina Melange, Vidar, Elle, Cotil
Fabric group 4	Grand Mohair, Sisu, Safire
Fabric group 5	Gentle
Leather group 0	Vice
Leather group 1	Omni
Leather group 2	Primo, Trace
Leather group 3	Max
Leather group 4	Nubuck, Vegeta, Organic, Cera

**Model
3078**

Lynderup Accessories Coupling device



Black coupling device in plastic for Lynderup Chair. The device is interchangeable and can be added to a standard chair. When not in use, it can be flipped under the seat and remain on the chair until next use and when stacking the chair.

Order configuration

For model 3080
and 3081

17

**Model
3079**

Lynderup Accessories
Chair suspensions

Chair suspensions in black powder coated steel.

Order configuration

	No template	Template enclosed
Black	69	162

Model 1004

Pato / Lynderup Accessories Transport trolley



Transport trolley for the stackable chairs Lynderup, Pato Sledge and Pato 4-Leg.
Black powder coated steel.

Modeldetails

0,77 m³ Packaging dimensions:
24 kg / L: 90 cm W: 59 cm H: 102 cm
18 kg

Order configuration

Black	1.019
-------	-------

Model 3236

Mogensen 3236 Chair Seat upholstered



Designed by Børge Mogensen, 1956

Frame of solid wood and back of wood moulded in layers. Plywood core seat upholstered with CMHR or HR foam and covered in fabric or leather.

Modeldetails

0,28 m³ Packaging dimensions:
7,5 kg / 6 kg L: 50 cm W: 54 cm H: 83 cm

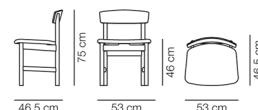

Essential Assortment

Item number	Upholstery	Wood	Price
323620351301	Leather Omni 301, Black	Oak soap, FSC Mix 70%	783
323622451301	Leather Omni 301, Black	Oak black lacquer, FSC Mix 70%	783

Essential variants only delivered with HR foam

Order configuration

	Oak black lacquered	Oak soap	Oak oiled	Oak light oil
Fabric group 1	897	815	923	923
Fabric group 2	942	856	965	965
Fabric group 3	999	908	1.017	1.017
Fabric group 4	1.071	973	1.082	1.082
Fabric group 5	1.124	1.022	1.131	1.131
C.O.M. fabric	897	815	923	923
Leather group 0	844	767	875	875
Leather group 1	907	825	933	933
Leather group 2	974	886	994	994
Leather group 3	1.062	965	1.074	1.074
Leather group 4	1.168	1.062	1.170	1.170
Leather group 5	1.343	1.221	1.329	1.329
C.O.M. leather	907	825	933	933

Fabric consumption: 0,6 m. Leather consumption: 0,67 m²

Extra charge for

QuickClick glides with or without felt (R3236): +24

Certifications

FSC® certified

Recommended upholstery

Fabric group 1	Grand Linen, Remix, Capture, Bardal, Re-wool, Ruskin, Natural Linen, Linara, Erik
Fabric group 2	Hallingdal, Barnum, Loop, Steelcut Trio, Sunniva, Harald, Foss, Fiord, Clay, Savoy
Fabric group 3	Cotil, Divina Melange, Vidar, Elle
Fabric group 4	Grand Mohair, Sisu, Safire
Fabric group 5	Gentle
Leather group 0	Vice
Leather group 1	Omni
Leather group 2	Primo
Leather group 3	Max
Leather group 4	Vegeta, Nubuck, Organic, Cera

Model 3171

The Mogensen Bench Seat upholstered



Designed by Børge Mogensen, 1956

Frame of solid wood. Back is made from a single piece of solid wood. Seat of plywood core generously upholstered with CMHR or HR foam and covered in fabric or leather.

Modeldetails

0,82 m³ Packaging dimensions:
23 kg / 21 kg L: 175 cm W: 59 cm H: 79 cm

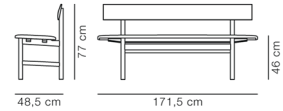

Essential Assortment

Item number	Upholstery	Wood	Price
317100651301	Leather Omni 301, Black	Oak black lacquered	2.916
317110551301	Leather Omni 301, Black	Oak oil	2.916
317110350090	Leather Vegeta 90, Natural	Oak soap	3.333
317110750095	Leather Max 95, Cognac	Oak light oil	3.333
317110951301	Leather Omni 301, Black	Smoked oak, oiled	3.333

Essential variants only delivered with HR foam

Order configuration

	Oak soap	Oak oiled	Oak light oil	Oak black lacquered	Smoked oak, oiled
Fabric group 1	2.988	3.025	2.988	3.287	3.437
Fabric group 2	3.118	3.155	3.118	3.430	3.586
Fabric group 3	3.282	3.319	3.282	3.610	3.774
Fabric group 4	3.485	3.522	3.485	3.834	4.008
Fabric group 5	3.660	3.697	3.660	4.026	4.209
C.O.M. fabric	2.988	3.025	2.988	3.287	3.437
Leather group 0	2.818	2.855	2.818	3.100	3.241
Leather group 1	3.030	3.067	3.030	3.333	3.485
Leather group 2	3.221	3.258	3.221	3.543	3.704
Leather group 3	3.470	3.507	3.470	3.817	3.991
Leather group 4	3.817	3.854	3.817	4.199	4.390
Leather group 5	4.390	4.426	4.390	4.829	5.048
C.O.M. leather	3.030	3.067	3.030	3.333	3.485

Fabric consumption: 1,8 m. Leather consumption: 2,5 m²

Extra charge for

QuickClick glides with or without felt (R3171): +24

Recommended upholstery

Fabric group 1	Grand Linen, Remix, Capture, Bardal, Re-wool, Ruskin, Natural Linen, Linara, Erik
Fabric group 2	Hallingdal, Barnum, Loop, Steelcut Trio, Sunniva, Harald, Foss, Fiord, Clay, Savoy
Fabric group 3	Cotil, Divina Melange, Vidar, Elle
Fabric group 4	Grand Mohair, Sisu, Safire
Fabric group 5	Gentle
Leather group 0	Vice
Leather group 1	Omni
Leather group 2	Primo
Leather group 3	Max
Leather group 4	Vegeta, Nubuck, Organic, Cera

Model 4200

Pato 4 Leg Chair Polypropylene seat



Designed by Welling / Ludvik, 2013

Stacking chair. Shell of 100% recycled coloured-through polypropylene. Frame of steel tube chromed or powder coated. Mounted with interchangeable plastic glides.

Modeldetails

0,48 m³ Packaging dimensions:
6,6 kg / 5 kg L: 59 cm W: 63 cm H: 95 cm

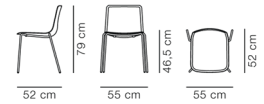

Essential Assortment

Item number	Shell	Frame	Price
42000740005	Quartz grey	Black	233
42001140005	White	Black	233
42001240005	Black	Black	233
42001540005	Ocean	Black	258
42001640005	Storm	Black	258
42001940005	Stone	Black	258
42002340005	Ancient green	Black	258
42002440005	Dark red	Black	258
42002540005	Dark grey	Black	258
42002740005	Sand	Black	258

Essential variants are delivered with plastic glides

Order configuration

	Standard colours Polypropylene	
Chrome or black	269	

Stackable: 25 pcs. on trolley, 18 pcs. on floor.

Extra charge for

Glides with felt:	+12
Other standard frame colours:	+30

Certifications

EU Ecolabel variant: Black powder-coated frame

EN 1021-1:2006 - Smouldering cigarette, EN 1021-2:2006 - Match flame equivalent, EN 1022:2005, EN 16139:2013 (L2)

Model 4202

Pato 4 Leg Chair Fully upholstered



Designed by Welling / Ludvik, 2013

Fully upholstered chair, stackable. Inner shell of 100% recycled polypropylene with CMHR or HR foam, covered in fabric or leather. Cover is non-removable. Frame of steel tube chromed or powder coated. Mounted with interchangeable plastic glides.

Modeldetails

0,36 m³ Packaging dimensions:
6,6 kg / 5 kg L: 58,5 cm W: 61 cm H: 94 cm

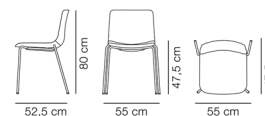

Essential Assortment

Item number	Upholstery	Frame	Price
42020130340005	Connect 60999	Black	483
42020746540005	Remix 123	Black	524
42021930040005	Re-Wool 198	Black	524
42021931140005	Re-Wool 128	Black	524
42025130140005	Leather Omni 301, Black	Black	599
42025130740005	Leather Omni 307, Cognac	Black	599

Essential variants are delivered with plastic glides and HR foam

Order configuration

Frame: Chrome or black.

Fabric group 0	526
Fabric group 1	553
Fabric group 2	605
Fabric group 3	671
Fabric group 4	754
Fabric group 5	830
C.O.M. fabric	553
Leather group 0	581
Leather group 1	624
Leather group 2	737
Leather group 3	885
Leather group 4	973
Leather group 5	1.119
C.O.M. leather	624

Fabric consumption: 0,62 m. Leather consumption: 1,3 m²

Stackable: 23 pcs. on trolley, 16 pcs. on floor.

Extra charge for

Glides with felt: +12
Other standard frame colours: +30

Certifications

EU Ecolabel variants: Black powder-coated frame together with HR foam and upholstery in Omni leather 301 black, Connect, Remix or Re-wool fabric
EN 1022:2005, EN 16139:2013 (L2)

Recommended upholstery

Fabric group 0	Connect
Fabric group 1	Grand Linen, Linara, Bardal, Capture, Remix, Re-wool, Ruskin, Natural Linen, Erik
Fabric group 2	Barnum, Hallingdal, Harald, Savoy, Clay, Sunniva, Steelcut Trio, Fiord, Foss, Loop
Fabric group 3	Vidar, Divina Melange, Elle, Cotil
Fabric group 4	Sisu, Grand Mohair, Safire
Fabric group 5	Gentle
Leather group 0	Vice
Leather group 1	Omni
Leather group 2	Primo, Trace
Leather group 3	Max
Leather group 4	Nubuck, Organic, Vegeta, Cera

Model 4210

Pato 4 Leg Armchair Polypropylene seat



Designed by Welling / Ludvik, 2013

Stacking chair with arms. Shell of 100% recycled coloured-through polypropylene. Arms of black powder coated aluminum. Frame of steel tube chromed or powder coated. Mounted with interchangeable plastic glides.

Modeldetails

0,48 m³ Packaging dimensions:
6,6 kg / L: 59 cm W: 63 cm H: 89 cm
5,9 kg



Order configuration

	Standard colours Polypropylene
Chrome or black	389

Stackable: 18 pcs. on trolley, 13 pcs. on floor.

Extra charge for

Glides with felt:	+12
Other standard frame colours:	+37

Certifications

EN 1021-1:2006 - Smouldering cigarette, EN 1021-2:2006 - Match flame equivalent, EN 1022:2005, EN 16139:2013 (L2)

Model 4212

Pato 4 Leg Armchair Fully upholstered



Designed by Welling / Ludvik, 2013

Fully upholstered chair with arms, stackable. Inner shell of 100% recycled polypropylene with CMHR or HR foam, covered in fabric or leather. Cover is non-removable. Arms of black powder coated aluminum. Frame of steel tube chromed or powder coated. Mounted with interchangeable plastic glides.

Modeldetails

0,36 m³ Packaging dimensions:
8,1 kg / 6,6 kg L: 58,5 cm W: 61 cm H: 94 cm

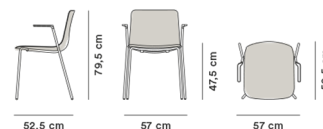

Essential Assortment

Item number	Upholstery	Frame	Price
4212013034000513	Connect 60999	Black	566
4212074654000513	Remix 123	Black	608
4212193004000513	Re-Wool 198	Black	608
4212193114000513	Re-Wool 128	Black	608
4212513014000513	Leather Omni 301, Black	Black	699
4212513074000513	Leather Omni 307, Cognac	Black	699

Essential variants are delivered with plastic glides and HR foam

Order configuration

Frame: Chrome or black.

Fabric group 0	643
Fabric group 1	675
Fabric group 2	728
Fabric group 3	794
Fabric group 4	876
Fabric group 5	964
C.O.M. fabric	675
Leather group 0	694
Leather group 1	747
Leather group 2	859
Leather group 3	1.007
Leather group 4	1.107
Leather group 5	1.274
C.O.M. leather	747

Fabric consumption: 0,62 m. Leather consumption: 1,3 m²

Stackable: 16 pcs. on trolley, 11 pcs. on floor.

Extra charge for

Glides with felt: +12
Other standard frame colours: +37

Certifications

EN 1022:2005, EN 16139:2013 (L2)

Recommended upholstery

Fabric group 0	Connect
Fabric group 1	Grand Linen, Linara, Bardal, Capture, Remix, Re-wool, Ruskin, Natural Linen, Erik
Fabric group 2	Barnum, Hallingdal, Harald, Savoy, Clay, Sunniva, Steelcut Trio, Fiord, Foss, Loop
Fabric group 3	Vidar, Divina Melange, Elle, Cotil
Fabric group 4	Sisu, Grand Mohair, Safire
Fabric group 5	Gentle
Leather group 0	Vice
Leather group 1	Omni
Leather group 2	Primo, Trace
Leather group 3	Max
Leather group 4	Nubuck, Organic, Vegeta, Cera

Model 4225

Pato Wood base Chair Polypropylene seat



Designed by Welling / Ludvik, 2016

Chair with solid wood legs. Shell of 100% recycled coloured-through polypropylene.

Modeldetails

0,4 m³

Packaging dimensions:

7 kg /
4,6 kg

L: 51,3 cm W: 56,1 cm H: 113,1 cm

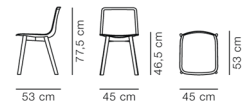

Order configuration

Frame: Oak lacquered or oak black lacquered.

Standard
colours
Polypropylene

370

Extra charge for

QuickClick glides with or without felt:

+12

Frame smoked oak stained, lacquered:

+13

Certifications

FSC® certified

EN 1021-1:2006 - Smouldering cigarette, EN 1021-2:2006 - Match flame equivalent, EN 1022:2005, EN 16139:2013 (L2)

Model 4222

Pato Wood base Chair Fully upholstered



Designed by Welling / Ludvik, 2016

Fully upholstered chair with solid wood frame. Inner shell of 100% recycled polypropylene with CMHR or HR foam, covered in fabric or leather. Cover is non-removable.

Modeldetails

0,4 m³ Packaging dimensions:
7 kg / 5 kg L: 74 cm W: 61 cm H: 95 cm

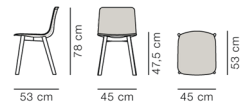

Essential Assortment

Item number	Upholstery	Frame	Price
422219300855000	Re-Wool 198	Smoked oak stained lacquer, FSC Mix 70%	608
422219311854000	Re-Wool 128	Oak lacquer, FSC Mix 70%	608
422251301855000	Leather Omni 301, Black	Smoked oak stained lacquer, FSC Mix 70%	699
422251307854000	Leather Omni 307, Cognac	Oak lacquer, FSC Mix 70%	699

Essential variants only delivered with HR foam

Order configuration

Frame: Oak lacquered, oak black lacquered or smoked oak stained, lacquered.

Fabric group 0	623
Fabric group 1	650
Fabric group 2	704
Fabric group 3	771
Fabric group 4	855
Fabric group 5	941
C.O.M. fabric	650
Leather group 0	672
Leather group 1	723
Leather group 2	838
Leather group 3	988
Leather group 4	1.087
Leather group 5	1.250
C.O.M. leather	723

Fabric consumption: 0,62 m. Leather consumption: 1,3 m²

Extra charge for

QuickClick glides with or without felt: +12

Certifications

FSC® certified
EN 1022:2005, EN 16139:2013 (L2)

Recommended upholstery

Fabric group 0	Connect
Fabric group 1	Grand Linen, Linara, Bardal, Capture, Remix, Re-wool, Ruskin, Natural Linen, Erik
Fabric group 2	Barnum, Hallingdal, Harald, Savoy, Clay, Sunniva, Steelcut Trio, Fiord, Foss, Loop
Fabric group 3	Vidar, Divina Melange, Elle, Cotil
Fabric group 4	Sisu, Grand Mohair, Safire
Fabric group 5	Gentle
Leather group 0	Vice
Leather group 1	Omni
Leather group 2	Primo, Trace
Leather group 3	Max
Leather group 4	Nubuck, Organic, Vegeta, Cera

Model 4100

Pato Sledge Chair Polypropylene seat



Designed by Welling / Ludvik, 2013

Stacking chair. Shell of 100% recycled coloured-through polypropylene. Frame of solid steel, chromed or powder coated. Mounted with interchangeable plastic glides.

Modeldetails

0,36 m³ Packaging dimensions:
7,5 kg / 6,2 kg L: 58 cm W: 64 cm H: 95 cm



Essential Assortment

Item number	Shell	Frame	Price
41000740040	Quartz grey	Black	233
41001140040	White	Black	233
41001240040	Black	Black	233
41001540040	Ocean	Black	258
41001640040	Storm	Black	258
41001940040	Stone	Black	258
41002340040	Ancient green	Black	258
41002440040	Dark red	Black	258
41002540040	Dark grey	Black	258
41002740040	Sand	Black	258

Essential variants are delivered with plastic glides

Order configuration

	Standard colours Polypropylene	
Chrome or black	257	

Stackable: 25 pcs. on trolley, 18 pcs. on floor.
Suitable for outdoor use when frame is powder coated.

Extra charge for

Glides with felt:	+12
Other standard frame colours:	+30

Certifications

EU Ecolabel variant: Black powder-coated frame
EN 1021-1:2006 - Smouldering cigarette, EN 1021-2:2006 - Match flame equivalent, EN 1022:2005, EN 16139:2013 (L1)

Model 4102

Pato Sledge Chair Fully upholstered



Designed by Welling / Ludvik, 2013

Fully upholstered chair, stackable. Inner shell of 100% recycled polypropylene with CMHR or HR foam, covered in fabric or leather. Cover is non-removable. Frame of solid steel, chromed or powder coated. Mounted with interchangeable plastic glides.

Modeldetails

0,36 m³ Packaging dimensions:
8,5 kg / 7 kg L: 58,5 cm W: 61 cm H: 94 cm



Essential Assortment

Item number	Upholstery	Frame	Price
41020130340040	Connect 60999	Black	483
41020746540040	Remix 123	Black	524
41021930040040	Re-Wool 198	Black	524
41021931140040	Re-Wool 128	Black	524
41025130140040	Leather Omni 301, Black	Black	599
41025130740040	Leather Omni 307, Cognac	Black	599

Essential variants are delivered with plastic glides and HR foam

Order configuration

Frame: Chrome or black.

Fabric group 0	526
Fabric group 1	553
Fabric group 2	605
Fabric group 3	671
Fabric group 4	754
Fabric group 5	830
C.O.M. fabric	553
Leather group 0	581
Leather group 1	624
Leather group 2	737
Leather group 3	885
Leather group 4	973
Leather group 5	1.119
C.O.M. leather	624

Fabric consumption: 0,62 m. Leather consumption: 1,3 m²

Stackable: 23 pcs. on trolley, 16 pcs. on floor.

Extra charge for

Glides with felt: +12
Other standard frame colours: +30

Certifications

EU Ecolabel variants: Black powder-coated frame together with HR foam and upholstery in Omni leather 301 black, Connect, Remix or Re-wool fabric
EN 1022:2005, EN 16139:2013 (L1)

Recommended upholstery

Fabric group 0	Connect
Fabric group 1	Grand Linen, Linara, Bardal, Capture, Remix, Re-wool, Ruskin, Natural Linen, Erik
Fabric group 2	Barnum, Hallingdal, Harald, Savoy, Clay, Sunniva, Steelcut Trio, Fiord, Foss, Loop
Fabric group 3	Vidar, Divina Melange, Elle, Cotil
Fabric group 4	Sisu, Grand Mohair, Safire
Fabric group 5	Gentle
Leather group 0	Vice
Leather group 1	Omni
Leather group 2	Primo, Trace
Leather group 3	Max
Leather group 4	Nubuck, Organic, Vegeta, Cera

Model 4110

Pato Sledge Armchair Polypropylene seat



Designed by Welling / Ludvik, 2013

Stacking chair with arms. Shell of 100% recycled coloured-through polypropylene. Frame of solid steel, chromed or powder coated. Mounted with interchangeable plastic glides.

Modeldetails

0,36 m³ Packaging dimensions:
8,3 kg / 6,8 kg L: 58,5 cm W: 61 cm H: 94 cm

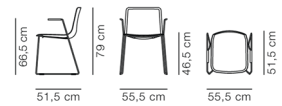

Order configuration

	Standard colours Polypropylene
Chrome or black	389

Stackable: 18 pcs. on trolley, 13 pcs. on floor.

Extra charge for

Glides with felt:	+12
Other standard frame colours:	+37

Certifications

EN 1021-1:2006 - Smouldering cigarette, EN 1021-2:2006 - Match flame equivalent, EN 16139:2013 (L1)

Model 4112

Pato Sledge Armchair Fully upholstered



Designed by Welling / Ludvik, 2013

Fully upholstered chair with arms, stackable. Inner shell of 100% recycled polypropylene with CMHR or HR foam, covered in fabric or leather. Cover is non-removable. Frame of solid steel, chromed or powder coated. Mounted with interchangeable plastic glides.

Modeldetails

0,36 m³ Packaging dimensions:
9,3 kg / 7,8 kg L: 58,5 cm W: 61 cm H: 94 cm



Essential Assortment

Item number	Upholstery	Frame	Price
4112013034004012	Connect 60999	Black	566
4112074654004012	Remix 123	Black	613
4112193004004012	Re-Wool 198	Black	613
4112193114004012	Re-Wool 128	Black	613
4112513014004012	Leather Omni 301, Black	Black	699
4112513074004012	Leather Omni 307, Cognac	Black	699

Essential variants are delivered with plastic glides and HR foam

Order configuration

Frame: Chrome or black.

Fabric group 0	643
Fabric group 1	675
Fabric group 2	728
Fabric group 3	794
Fabric group 4	876
Fabric group 5	964
C.O.M. fabric	675
Leather group 0	694
Leather group 1	747
Leather group 2	859
Leather group 3	1.007
Leather group 4	1.107
Leather group 5	1.274
C.O.M. leather	747

Fabric consumption: 0,62 m. Leather consumption: 1,3 m²

Stackable: 16 pcs. on trolley, 11 pcs. on floor.

Extra charge for

Glides with felt: +12
Other standard frame colours: +37

Certifications

EN 16139:2013 (L1)

Recommended upholstery

Fabric group 0	Connect
Fabric group 1	Grand Linen, Linara, Bardal, Capture, Remix, Re-wool, Ruskin, Natural Linen, Erik
Fabric group 2	Barnum, Hallingdal, Harald, Savoy, Clay, Sunniva, Steelcut Trio, Fiord, Foss, Loop
Fabric group 3	Vidar, Divina Melange, Elle, Cotil
Fabric group 4	Sisu, Grand Mohair, Safire
Fabric group 5	Gentle
Leather group 0	Vice
Leather group 1	Omni
Leather group 2	Primo, Trace
Leather group 3	Max
Leather group 4	Nubuck, Organic, Vegeta, Cera

Model 4300



Pato Sledge Barstool Polypropylene seat

Designed by Welling / Ludvik, 2013

Barstool. Shell of 100% recycled coloured-through polypropylene. Frame of solid steel, chromed or powder coated. Mounted with interchangeable plastic glides. Please specify bar or counter height.

Modeldetails

0,34 m³ Packaging dimensions:
8 kg / 7,5 kg L: 57 cm W: 52 cm H: 115 cm

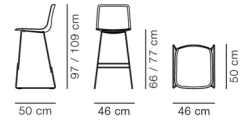

Order configuration

Bar or counter height.

	Standard colours Polypropylene
Chrome or black	335

Extra charge for

Glides with felt:	+12
Other standard frame colours:	+46

Certifications

EN 1021-1:2006 - Smouldering cigarette, EN 1021-2:2006 - Match flame equivalent, EN 1022:2005, EN 16139:2013 (L2)

Model 4302



Pato Sledge Barstool Fully upholstered

Designed by Welling / Ludvik, 2013

Fully upholstered barstool. Inner shell of 100% recycled polypropylene with CMHR or HR foam, covered in fabric or leather. Cover is non-removable. Frame of solid steel, chromed or powder coated. Mounted with interchangeable plastic glides. Please specify bar or counter height.

Modeldetails

0,34 m³ Packaging dimensions:
9 kg / 8 kg L: 57 cm W: 53 cm H: 107 cm

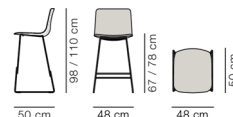

Order configuration

Frame: Chrome or black.
Bar or counter height.

Fabric group 0	603
Fabric group 1	634
Fabric group 2	686
Fabric group 3	752
Fabric group 4	835
Fabric group 5	919
C.O.M. fabric	634
Leather group 0	656
Leather group 1	705
Leather group 2	818
Leather group 3	966
Leather group 4	1.062
Leather group 5	1.221
C.O.M. leather	705

Fabric consumption: 0,62 m. Leather consumption: 1,3 m²

Extra charge for

Glides with felt: +12
Other standard frame colours: +46

Certifications

EN 1022:2005, EN 16139:2013 (L2)

Recommended upholstery

Fabric group 0	Connect
Fabric group 1	Grand Linen, Linara, Bardal, Capture, Remix, Re-wool, Ruskin, Natural Linen, Erik
Fabric group 2	Barnum, Hallingdal, Harald, Savoy, Clay, Sunniva, Steelcut Trio, Fiord, Foss, Loop
Fabric group 3	Vidar, Divina Melange, Elle, Cotil
Fabric group 4	Sisu, Grand Mohair, Safire
Fabric group 5	Gentle
Leather group 0	Vice
Leather group 1	Omni
Leather group 2	Primo, Trace
Leather group 3	Max
Leather group 4	Nubuck, Organic, Vegeta, Cera

Model 4310

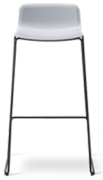

Pato Sledge Stool Polypropylene seat

Designed by Welling / Ludvik, 2016

Stackable barstool. Shell of 100% recycled coloured-through polypropylene. Frame of solid steel, chromed or powder coated. Mounted with interchangeable plastic glides. Please specify bar or counter height.

Modeldetails

0,34 m³ Packaging dimensions:
7,5 kg / 6,1 kg L: 53 cm W: 57 cm H: 102 cm

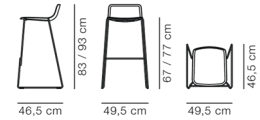

Essential Assortment

Item number	Shell	Frame	Height	Price
4310074004077	Quartz grey	Black	Sh 77 cm	316
4310124004077	Black	Black	Sh 77 cm	316

Essential variants are delivered with plastic glides

Order configuration

Bar or counter height.

	Standard colours Polypropylene	
Chrome or black	327	

Stackable: 14 pcs. on floor.

Extra charge for

Glides with felt:	+12
Other standard frame colours:	+46

Certifications

EN 1021-1:2006 - Smouldering cigarette, EN 1021-2:2006 - Match flame equivalent, EN 1022:2005, EN 16139:2013 (L2)

Model 4312

Pato Sledge Stool Fully upholstered



Designed by Welling / Ludvik, 2016

Fully upholstered barstool, stackable. Inner shell of 100% recycled polypropylene with CMHR or HR foam, covered in fabric or leather. Cover is non-removable. Frame of solid steel, chromed or powder coated. Mounted with interchangeable plastic glides. Please specify bar or counter height.

Modeldetails

0,32 m³ Packaging dimensions:
8,5 kg / 6,4 kg L: 51,5 cm W: 56 cm H: 113 cm

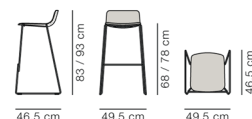

Essential Assortment

Item number	Upholstery	Frame	Height	Price
43120130340040780	Connect 60999	Black	Sh 78 cm	549
43120746540040780	Remix 123	Black	Sh 78 cm	549
43121930040040780	Re-Wool 198	Black	Sh 78 cm	549
43121931140040780	Re-Wool 128	Black	Sh 78 cm	549
43125130140040780	Leather Omni 301, Black	Black	Sh 78 cm	641
43125130740040780	Leather Omni 307, Cognac	Black	Sh 78 cm	641

Essential variants are delivered with plastic glides and HR foam

Order configuration

Frame: Chrome or black.
Bar or counter height.

Fabric group 0	592
Fabric group 1	622
Fabric group 2	676
Fabric group 3	743
Fabric group 4	828
Fabric group 5	910
C.O.M. fabric	622
Leather group 0	647
Leather group 1	695
Leather group 2	810
Leather group 3	960
Leather group 4	1.056
Leather group 5	1.215
C.O.M. leather	695

Fabric consumption: 0,5 m. Leather consumption: 1,12 m²

Stackable: 12 pcs. on floor.

Extra charge for

Glides with felt: +12
Other standard frame colours: +46

Certifications

EN 1022:2005, EN 16139:2013 (L2)

Recommended upholstery

Fabric group 0	Connect
Fabric group 1	Grand Linen, Linara, Bardal, Capture, Remix, Re-wool, Ruskin, Natural Linen, Erik
Fabric group 2	Barnum, Hallingdal, Harald, Savoy, Clay, Sunniva, Steelcut Trio, Fiord, Foss, Loop
Fabric group 3	Vidar, Divina Melange, Elle, Cotil
Fabric group 4	Sisu, Grand Mohair, Safire
Fabric group 5	Gentle
Leather group 0	Vice
Leather group 1	Omni
Leather group 2	Primo, Trace
Leather group 3	Max
Leather group 4	Nubuck, Organic, Vegeta, Cera

Model 4010

Pato Swivel Armchair Polypropylene seat



Designed by Welling / Ludvik, 2014

Swivel chair with arms. Shell of 100% recycled coloured-through polypropylene. 4-star aluminum base, polished or powder coated. Mounted with plastic glides.

Modeldetails

0,25 m³ Packaging dimensions:
12 kg / L: 52 cm W: 57 cm H: 86 cm
10 kg

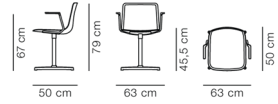

Order configuration

Standard colours Polypropylene

Polished aluminium or black	707
-----------------------------	-----

Other frame colours by quotation (min. 25 pcs.).

Extra charge for

Glides with felt:	+12
Castors, chrome or black:	+26

Certifications

EN 1021-1:2006 - Smouldering cigarette, EN 1021-2:2006 - Match flame equivalent

Model 4012

Pato Swivel Armchair Fully upholstered



Designed by Welling / Ludvik, 2014

Fully upholstered swivel chair with arms. Inner shell of 100% recycled polypropylene with CMHR or HR foam, covered in fabric or leather. Cover is non-removable. 4-star aluminum base, polished or powder coated. Mounted with plastic glides.

Modeldetails

0,25 m³ Packaging dimensions:
13 kg / L: 62,5 cm W: 70,6 cm H: 100,4 cm
10,6 kg

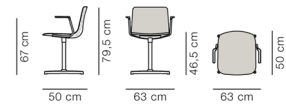

Order configuration

Frame: Polished aluminium or black.

Fabric group 0	943
Fabric group 1	990
Fabric group 2	1.046
Fabric group 3	1.115
Fabric group 4	1.202
Fabric group 5	1.322
C.O.M. fabric	990
Leather group 0	991
Leather group 1	1.066
Leather group 2	1.184
Leather group 3	1.338
Leather group 4	1.472
Leather group 5	1.693
C.O.M. leather	1.066

Fabric consumption: 0,62 m. Leather consumption: 1,3 m²

Other frame colours by quotation (min. 25 pcs.).

Extra charge for

Glides with felt:	+12
Castors, chrome or black:	+26

Recommended upholstery

Fabric group 0	Connect
Fabric group 1	Grand Linen, Linara, Capture, Remix, Natural Linen, Re-wool, Ruskin, Erik
Fabric group 2	Hallingdal, Harald, Savoy, Clay, Barnum, Sunniva, Steelcut Trio, Fiord, Foss, Loop
Fabric group 3	Vidar, Divina Melange, Elle, Cotil
Fabric group 4	Sisu, Grand Mohair, Safire
Fabric group 5	Gentle
Leather group 0	Vice
Leather group 1	Omni
Leather group 2	Primo, Trace
Leather group 3	Max
Leather group 4	Nubuck, Vegeta, Organic, Cera

Model 4022

Pato Office Chair Fully upholstered



Designed by Welling / Ludvik, 2014

Fully upholstered height-adjustable swivel chair. Inner shell of 100% recycled polypropylene with CMHR or HR foam, covered in fabric or leather. Cover is non-removable. 5-star base with castors, aluminum polished or powder coated.

Modeldetails

0,42 m³ Packaging dimensions:
13 kg / L: 69 cm W: 69 cm H: 88 cm
10,3 kg

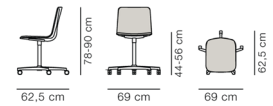

Order configuration

Frame: Polished aluminum or black.

Fabric group 0	829
Fabric group 1	871
Fabric group 2	921
Fabric group 3	986
Fabric group 4	1.066
Fabric group 5	1.173
C.O.M. fabric	871
Leather group 0	874
Leather group 1	940
Leather group 2	1.049
Leather group 3	1.193
Leather group 4	1.312
Leather group 5	1.509
C.O.M. leather	940

Fabric consumption: 0,62 m. Leather consumption: 1,3 m²

Other frame colours by quotation (min. 25 pcs.).

Certifications

EN 1022:2005, EN 16139:2013 (L1)

Recommended upholstery

Fabric group 0	Connect
Fabric group 1	Grand Linen, Linara, Bardal, Capture, Remix, Re-wool, Ruskin, Natural Linen, Erik
Fabric group 2	Barnum, Hallingdal, Harald, Savoy, Clay, Sunniva, Steelcut Trio, Fiord, Foss, Loop
Fabric group 3	Vidar, Divina Melange, Elle, Cotil
Fabric group 4	Sisu, Grand Mohair, Safire
Fabric group 5	Gentle
Leather group 0	Vice
Leather group 1	Omni
Leather group 2	Primo, Trace
Leather group 3	Max
Leather group 4	Nubuck, Organic, Vegeta, Cera

Model 4052



Pato Executive Armchair Swivel base

Designed by Welling / Ludvik, 2015

Fully upholstered swivel chair with arms. Inner shell of plywood with CMHR or HR foam, covered in fabric or leather. Cover is non-removable. 4-star aluminum base, polished or powder coated. Mounted with plastic glides.

Modeldetails

0,32 m³ Packaging dimensions:
12 kg / L: 58,5 cm W: 63,5 cm H: 89 cm
10,5 kg

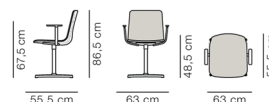

Order configuration

Frame: Polished aluminium or black.

Fabric group 0	1.025
Fabric group 1	1.102
Fabric group 2	1.184
Fabric group 3	1.287
Fabric group 4	1.416
Fabric group 5	1.558
C.O.M. fabric	1.102
Leather group 0	1.170
Leather group 1	1.258
Leather group 2	1.464
Leather group 3	1.733
Leather group 4	1.906
Leather group 5	2.192
C.O.M. leather	1.258

Fabric consumption: 0,9 m. Leather consumption: 2,3 m²

Other frame colours by quotation (min. 25 pcs.).

Extra charge for

Glides with felt:	+12
Castors, chrome or black	+26

Certifications

FSC® certified
EN 1022:2005, EN 16139:2013 (L1)

Recommended upholstery

Fabric group 0	Connect
Fabric group 1	Grand Linen, Linara, Bardal, Capture, Remix, Re-wool, Ruskin, Natural Linen, Erik
Fabric group 2	Barnum, Hallingdal, Harald, Savoy, Clay, Sunniva, Steelcut Trio, Fiord, Foss, Loop
Fabric group 3	Vidar, Divina Melange, Elle, Cotil
Fabric group 4	Sisu, Grand Mohair, Safire
Fabric group 5	Gentle
Leather group 0	Vice
Leather group 1	Omni
Leather group 2	Primo, Trace
Leather group 3	Max
Leather group 4	Nubuck, Organic, Vegeta, Cera

Model 4072



Pato Executive Armchair

Height adjustable swivel base

Designed by Welling / Ludvik, 2015

Fully upholstered height-adjustable swivel chair with arms. Inner shell of plywood with CMHR or HR foam, covered in fabric or leather. Cover is non-removable. 5-star base with castors, aluminum polished or powder coated.

Model details

0,4 m³ Packaging dimensions:
14 kg / L: 64 cm W: 71 cm H: 104 cm
11,9 kg

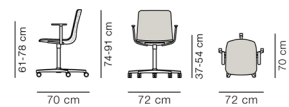

Order configuration

Frame: Polished aluminium or black.

Fabric group 0	1.074
Fabric group 1	1.155
Fabric group 2	1.237
Fabric group 3	1.340
Fabric group 4	1.470
Fabric group 5	1.617
C.O.M. fabric	1.155
Leather group 0	1.220
Leather group 1	1.312
Leather group 2	1.517
Leather group 3	1.786
Leather group 4	1.965
Leather group 5	2.259
C.O.M. leather	1.312

Fabric consumption: 0,9 m. Leather consumption: 2,3 m²

Other frame colours by quotation (min. 25 pcs.).

Certifications

FSC® certified

EN 1022:2005, EN 16139:2013 (L1)

Recommended upholstery

Fabric group 0	Connect
Fabric group 1	Grand Linen, Linara, Bardal, Capture, Remix, Re-wool, Ruskin, Natural Linen, Erik
Fabric group 2	Barnum, Hallingdal, Harald, Savoy, Clay, Sunniva, Steelcut Trio, Fiord, Foss, Loop
Fabric group 3	Vidar, Divina Melange, Elle, Cotil
Fabric group 4	Sisu, Grand Mohair, Safire
Fabric group 5	Gentle
Leather group 0	Vice
Leather group 1	Omni
Leather group 2	Primo, Trace
Leather group 3	Max
Leather group 4	Nubuck, Organic, Vegeta, Cera

Model 1004

Pato / Lynderup Accessories Transport trolley



Transport trolley for the stackable chairs Lynderup, Pato Sledge and Pato 4-Leg.
Black powder coated steel.

Modeldetails

0,77 m³ Packaging dimensions:
24 kg / L: 90 cm W: 59 cm H: 102 cm
18 kg

Order configuration

Black	1.019
-------	-------

**Model
1068**

Pato Accessories
Chair suspensions for barstool

Chair suspensions in black powder coated steel.

Order configuration

	No template	Template enclosed
Black	86	203

**Model
1069**

Pato Accessories
Chair suspensions for chair

Chair suspensions in black powder coated steel.

Order configuration

	No template	Template enclosed
Black	86	203

Model 6830

Pioneer Stool, H 46 cm



Designed by Maria Bruun, 2023

Stackable stool with a base in solid wood. Seat consists of an inner construction of a MDF core with HR or CMHR foam and upholstered with a removable fabric cover with zippers or non-removable cover in leather. Upholstered seat is removable. Metal screws and fittings. Mounted with plastic glides, felt glides are available.

Modeldetails

0,09 m³ Packaging dimensions:
7 kg / 4 kg L: 42 cm W: 42 cm H: 50 cm

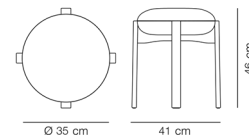

Essential Assortment

Item number	Upholstery	Frame	Price
6830002070854400	Hallingdal 200	Oak lacquer, FSC Mix 70%	591
6830002220855400	Hallingdal 370	Smoked oak stained lacquer, FSC Mix 70%	649
6830020390854400	Zero 0001	Oak lacquer, FSC Mix 70%	708
6830406280855400	Vidar 386	Smoked oak stained lacquer, FSC Mix 70%	708
6830508610855400	Leather Primo 86-1, Dark brown	Smoked oak stained lacquer, FSC Mix 70%	708
6830500900854400	Leather Vegeta 90, Natural	Oak lacquer, FSC Mix 70%	766

Essential variants are delivered with plastic glides and HR foam

Order configuration

	Beech black lacquered	Oak lacquered	Smoked oak stained, lacquered
Fabric group 1	591	650	709
Fabric group 2	620	680	736
Fabric group 3	647	708	764
Fabric group 4	693	755	811
Fabric group 5	785	849	905
C.O.M. fabric	591	650	709
Leather group 1	641	702	758
Leather group 2	665	727	783
Leather group 3	672	731	783
Leather group 4	725	784	837
Leather group 5	817	878	931
C.O.M. leather	641	702	758

Fabric consumption: 0,5 m. Leather consumption: 0,5 m²

Stackable: 6 pcs. on floor.

Certifications

FSC® certified

EN 1022:2005, EN 16139:2013 (L2)

Recommended upholstery

Fabric group 1	Linara, Bardal, Capture, Re-wool, Ruskin, Natural Linen, Erik
Fabric group 2	Hallingdal, Clay, Barnum, Sunniva, Steelcut Trio, Fiord, Foss, Loop
Fabric group 3	Vidar, Divina Melange, Elle
Fabric group 4	Safire
Fabric group 5	Gentle
Leather group 1	Omni
Leather group 2	Primo, Trace
Leather group 3	Max
Leather group 4	Nubuck, Vegeta, Organic

Model 6831



Pioneer Stool

Designed by Maria Bruun, 2023

Stool in two optional heights with a base in solid wood and footrest in plywood. Seat consists of an inner construction of a MDF core with HR or CMHR foam and upholstered with a removable fabric cover with zippers or non-removable cover in leather. Upholstered seat is removable. Metal screws and fittings. Mounted with plastic glides, felt glides are available. Please specify counter- or bar height.

Modeldetails

0,15 m³ Packaging dimensions:
8,5 kg / 5,5 kg L: 42 cm W: 42 cm H: 82 cm

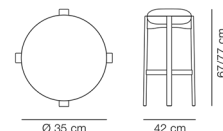

Essential Assortment

Item number	Upholstery	Frame	Height	Price
68310020708540177400	Hallingdal 200	Oak lacquer, FSC Mix 70%	Sh 77 cm	824
68310022208550177400	Hallingdal 370	Smoked oak stained lacquer, FSC Mix 70%	Sh 77 cm	883
68310203908540177400	Zero 0001	Oak lacquer, FSC Mix 70%	Sh 77 cm	941
68314062808550177400	Vidar 386	Smoked oak stained lacquer, FSC Mix 70%	Sh 77 cm	941
68315086108550177400	Leather Primo 86-1, Dark brown	Smoked oak stained lacquer, FSC Mix 70%	Sh 77 cm	941
68315009008540177400	Leather Vegeta 90, Natural	Oak lacquer, FSC Mix 70%	Sh 77 cm	966

Essential variants are delivered with plastic glides, HR foam and bar height

Order configuration

Bar or counter height.

	Beech black lacquered	Oak lacquered	Smoked oak stained, lacquered
Fabric group 1	768	886	945
Fabric group 2	795	916	974
Fabric group 3	821	944	1.001
Fabric group 4	866	991	1.046
Fabric group 5	955	1.085	1.136
C.O.M. fabric	768	886	945
Leather group 1	815	938	995
Leather group 2	839	963	1.019
Leather group 3	834	952	1.003
Leather group 4	885	1.006	1.056
Leather group 5	975	1.100	1.146
C.O.M. leather	815	938	995

Fabric consumption: 0,5 m. Leather consumption: 0,5 m²

Certifications

FSC® certified
EN 1022:2005, EN 16139:2013 (L2)

Recommended upholstery

Fabric group 1	Linara, Bardal, Capture, Re-wool, Ruskin, Natural Linen, Erik
Fabric group 2	Hallingdal, Clay, Barnum, Sunniva, Steelcut Trio, Fiord, Foss, Loop
Fabric group 3	Vidar, Divina Melange, Elle
Fabric group 4	Safire
Fabric group 5	Gentle
Leather group 1	Omni
Leather group 2	Primo, Trace
Leather group 3	Max
Leather group 4	Nubuck, Vegeta, Organic

Model 3412



Plan Chair Wooden seat

Designed by Edward Barber & Jay Osgerby, 2022

Chair with steel frame and plywood veneer seat and back finished with water-based lacquer.
Frame is powder coated tubular steel mounted with plastic glides. Felt glides available.

Modeldetails

0,28 m³ Packaging dimensions:
8,2 kg / L: 46 cm W: 60 cm H: 100 cm
6,8 kg

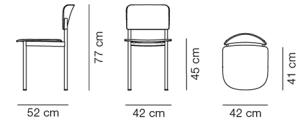

Essential Assortment

Item number	Wood	Frame	Price
341240020256	Oak lacquer FSC Mix 70%	Black	333
341240022356	Black ash, FSC Mix 70%	Black	333

Essential variants are delivered with plastic glides

Order configuration

	Oak lacquered	Black ash
Black	333	333
Modernist green	414	414
Bordeaux	414	414

Spare parts: Glides with or without felt (R3412G)

Certifications

EU Ecolabel
FSC® certified
ANSI/BIFMA X5.4-2020

Model 3413



Plan Chair Seat upholstered

Designed by Edward Barber & Jay Osgerby, 2022

Chair with steel frame, fully upholstered seat, plywood veneer back finished with water-based lacquer. Inner seat in plywood with CMHR or HR foam covered in fabric or leather.
Frame is powder coated tubular steel mounted with plastic glides. Felt glides available.

Modeldetails

0,28 m³ Packaging dimensions:
8,2 kg / 6,7 kg L: 46 cm W: 60 cm H: 100 cm

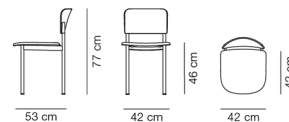

Essential Assortment

Item number	Upholstery	Wood	Frame	Price
341340020219311056	Re-Wool 128	Oak lacquer FSC Mix 70%	Black	433
341340022319300056	Re-Wool 198	Black ash, FSC Mix 70%	Black	433
341340022351301056	Leather Omni 301, Black	Black ash, FSC Mix 70%	Black	483

Essential variants are delivered with plastic glides and HR foam

Order configuration

Frame: Black, Modernist green or Bordeaux.

	Oak lacquered	Black ash
Fabric group 0	488	488
Fabric group 1	496	496
Fabric group 2	527	527
Fabric group 3	556	556
Fabric group 4	611	611
Fabric group 5	676	676
C.O.M. fabric	496	496
Leather group 0	507	507
Leather group 1	548	548
Leather group 2	565	565
Leather group 3	581	581
Leather group 4	615	615
Leather group 5	685	685
C.O.M. leather	548	548

Fabric consumption: 0,6 m. Leather consumption: 0,7 m²

Spare parts: Glides with or without felt (R3412G)

Certifications

EU Ecolabel variants: Modernist Green, Bordeaux or black powder-coated frame together with HR foam and upholstery in Omni leather, Connect, Remix, Re-wool or Steelcut Quartet fabric

FSC® certified

ANSI/BIFMA X5.4-2020

Recommended upholstery

Fabric group 0	Connect
Fabric group 1	Linara, Bardal, Capture, Remix, Natural Linen, Re-wool, Ruskin, Grand Linen, Erik
Fabric group 2	Hallingdal, Harald, Savoy, Clay, Barnum, Sunniva, Steelcut Trio, Fiord, Foss, Loop
Fabric group 3	Vidar, Divina Melange, Elle, Cotil
Fabric group 4	Safire, Sisu, Grand Mohair
Fabric group 5	Gentle
Leather group 0	Vice
Leather group 1	Omni
Leather group 2	Primo, Trace
Leather group 3	Max
Leather group 4	Nubuck, Organic, Vegeta, Cera

Model 3414



Plan Chair Fully upholstered

Designed by Edward Barber & Jay Osgerby, 2022

Fully upholstered chair with frame in tubular steel, powder coated or brushed steel. Inner backrest frame in steel with moulded foam and inner seat in plywood with CMHR or HR foam covered in fabric or leather. Mounted with plastic glides. Felt glides available.

Modeldetails

0,14 m³ Packaging dimensions:
8 kg / 6,5 kg L: 46 cm W: 60 cm H: 100 cm

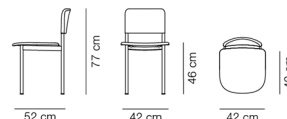

Essential Assortment

Item number	Upholstery	Frame	Price
3414400193000561	Re-Wool 198	Black	483
3414537041420561	Steelcut Quartet 924	Modernist green	483
3414538041400561	Steelcut Quartet 554	Bordeaux	483
3414500193110561	Re-Wool 128	Brushed steel	524
3414400513010561	Leather Omni 301, Black	Black	613
3414400500950561	Leather Max 95, Cognac	Black	649
3414500513010561	Leather Omni 301, Black	Brushed steel	649
3414500500950561	Leather Max 95, Cognac	Brushed steel	699

Essential variants are delivered with plastic glides and HR foam

Order configuration

Frame: Brushed Steel or standard colours: Black, Modernist green, Bordeaux

	Standard colours	Brushed Steel
Fabric group 0	562	631
Fabric group 1	571	639
Fabric group 2	600	669
Fabric group 3	629	698
Fabric group 4	682	752
Fabric group 5	744	815
C.O.M. fabric	571	639
Leather group 0	624	699
Leather group 1	649	721
Leather group 2	675	756
Leather group 3	687	763
Leather group 4	720	797
Leather group 5	788	865
C.O.M. leather	649	721

Fabric consumption: 1 m. Leather consumption: 1 m²

Spare parts: Glides with or without felt (R3412G)

Certifications

EU Ecolabel variants: Brushed Steel, Modernist Green, Bordeaux or black powder-coated frame together with HR foam and upholstery in Omni leather, Connect, Remix, Re-wool or Steelcut Quartet fabric

FSC® certified

ANSI/BIFMA X5.4-2020

Recommended upholstery

Fabric group 0	Connect
Fabric group 1	Linara, Bardal, Capture, Remix, Natural Linen, Re-wool, Ruskin, Grand Linen, Erik
Fabric group 2	Hallingdal, Harald, Savoy, Clay, Barnum, Sunniva, Steelcut Trio, Fiord, Foss, Loop
Fabric group 3	Vidar, Divina Melange, Elle, Cotil
Fabric group 4	Safire, Sisu, Grand Mohair
Fabric group 5	Gentle
Leather group 0	Vice
Leather group 1	Omni
Leather group 2	Primo, Trace
Leather group 3	Max
Leather group 4	Nubuck, Organic, Vegeta, Cera

Model 3432



Plan Barstool Wooden seat

Designed by Edward Barber & Jay Osgerby, 2023

Barstool with steel frame and plywood veneer seat and back finished with water-based lacquer.
Frame is powder coated tubular steel mounted with plastic glides. Felt glides available. Please specify bar or counter height.

Modeldetails

0,273 m³ Packaging dimensions:
11,6 kg / 8,8 kg L: 54 cm W: 46 cm H: 110 cm

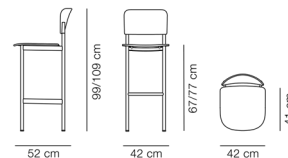

Essential Assortment

Item number	Wood	Frame	Price
34324002027856	Oak lacquer FSC Mix 70%	Black	583
34324002237856	Black ash, FSC Mix 70%	Black	583

Essential variants are delivered with plastic glides, HR foam and bar height

Order configuration

Bar or counter height.

	Oak lacquered	Black ash
Black	583	583
Modernist green	614	614
Bordeaux	614	614

Spare parts: Glides with or without felt (R3412G)

Certifications

EU Ecolabel
FSC® certified
ANSI/BIFMA X5.4-2020

Model 3433



Plan Barstool Seat upholstered

Designed by Edward Barber & Jay Osgerby, 2023

Barstool with steel frame, fully upholstered seat, plywood veneer back finished with water-based lacquer. Inner seat in plywood with CMHR or HR foam covered in fabric or leather. Frame is powder coated tubular steel mounted with plastic glides. Felt glides available. Please specify bar or counter height.

Modeldetails

0,273 m³ Packaging dimensions:
11,6 kg / 8,8 kg L: 54 cm W: 46 cm H: 110 cm

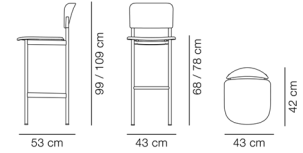

Essential Assortment

Item number	Upholstery	Wood	Frame	Price
34334002021931107856	Re-Wool 128	Oak lacquer FSC Mix 70%	Black	649
34334002231930007856	Re-Wool 198	Black ash, FSC Mix 70%	Black	649
34334002235130107856	Leather Omni 301, Black	Black ash, FSC Mix 70%	Black	708

Essential variants are delivered with plastic glides, HR foam and bar height

Order configuration

Frame: Black, Modernist green or Bordeaux.
Bar or counter height.

	Oak lacquered	Black ash
Fabric group 0	685	685
Fabric group 1	765	765
Fabric group 2	799	799
Fabric group 3	833	833
Fabric group 4	893	893
Fabric group 5	1.004	1.004
C.O.M. fabric	765	765
Leather group 0	777	777
Leather group 1	813	813
Leather group 2	849	849
Leather group 3	863	863
Leather group 4	940	940
Leather group 5	1.073	1.073
C.O.M. leather	813	813

Fabric consumption: 0,6 m. Leather consumption: 0,7 m²

Spare parts: Glides with or without felt (R3412G)

Certifications

EU Ecolabel variants: Modernist Green, Bordeaux or black powder-coated frame together with HR foam and upholstery in Omni leather, Connect, Remix, Re-wool or Steelcut Quartet fabric

FSC® certified

ANSI/BIFMA X5.4-2020

Recommended upholstery

Fabric group 0	Connect
Fabric group 1	Grand Linen, Linara, Bardal, Capture, Remix, Natural Linen, Re-wool, Ruskin, Erik
Fabric group 2	Hallingdal, Harald, Savoy, Clay, Barnum, Sunniva, Steelcut Trio, Fiord, Foss, Loop
Fabric group 3	Vidar, Divina Melange, Elle, Cotil
Fabric group 4	Sisu, Grand Mohair, Safire
Fabric group 5	Gentle
Leather group 0	Vice
Leather group 1	Omni
Leather group 2	Primo, Trace
Leather group 3	Max
Leather group 4	Nubuck, Vegeta, Organic, Cera

Model 3434

Plan Barstool Fully upholstered



Designed by Edward Barber & Jay Osgerby, 2023

Fully upholstered barstool with frame in tubular steel, powder coated or brushed steel.
Inner backrest frame in steel with moulded foam and inner seat in plywood with CMHR or HR foam covered in fabric or leather.
Mounted with plastic glides. Felt glides available. Please specify bar or counter height.

Modeldetails

0,273 m³ Packaging dimensions:
12 kg / L: 54 cm W: 46 cm H: 110 cm
9,1 kg

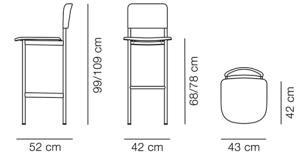

Essential Assortment

Item number	Upholstery	Frame	Price
343440019300078561	Re-Wool 198	Black	708
343453704142078561	Steelcut Quartet 924	Modernist green	708
343453804140078561	Steelcut Quartet 554	Bordeaux	708
343440051301078561	Leather Omni 301, Black	Black	891
343440050095078561	Leather Max 95, Cognac	Black	949
343450019311078561	Re-Wool 128	Brushed steel	949
343450051301078561	Leather Omni 301, Black	Brushed steel	1.066
343450050095078561	Leather Max 95, Cognac	Brushed steel	1.124

Essential variants are delivered with plastic glides, HR foam and bar height

Order configuration

Frame: Brushed Steel or standard colours: Black, Modernist green, Bordeaux
Bar or counter height.

	Standard colours	Brushed Steel
Fabric group 0	773	986
Fabric group 1	905	1.116
Fabric group 2	963	1.173
Fabric group 3	1.019	1.228
Fabric group 4	1.120	1.328
Fabric group 5	1.304	1.509
C.O.M. fabric	905	1.116
Leather group 0	905	1.116
Leather group 1	958	1.168
Leather group 2	1.008	1.217
Leather group 3	1.041	1.235
Leather group 4	1.150	1.343
Leather group 5	1.340	1.531
C.O.M. leather	958	1.168

Fabric consumption: 1 m. Leather consumption: 1 m²

Spare parts: Glides with or without felt (R3412G)

Certifications

EU Ecolabel variants: Brushed Steel, Modernist Green, Bordeaux or black powder-coated frame together with HR foam and upholstery in Omni leather, Connect, Remix, Re-wool or Steelcut Quartet fabric

FSC® certified

ANSI/BIFMA X5.4-2020

Recommended upholstery

Fabric group 0	Connect
Fabric group 1	Grand Linen, Linara, Bardal, Capture, Remix, Natural Linen, Re-wool, Ruskin, Erik
Fabric group 2	Hallingdal, Harald, Savoy, Clay, Barnum, Sunniva, Steelcut Trio, Fiord, Foss, Loop
Fabric group 3	Vidar, Divina Melange, Elle, Cotil
Fabric group 4	Sisu, Grand Mohair, Safire
Fabric group 5	Gentle
Leather group 0	Vice
Leather group 1	Omni
Leather group 2	Primo, Trace
Leather group 3	Max
Leather group 4	Nubuck, Vegeta, Organic, Cera

Model 3445

Post Armchair Wooden seat



Designed by Cecilie Manz, 2019

Frame of solid wood. Back and seat of moulded veneer. Veneer core in the same wood as top veneer.

Modeldetails

0,25 m³ Packaging dimensions:
7,9 kg / 5 kg L: 53 cm W: 57 cm H: 82,5 cm

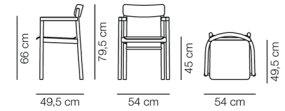

Essential Assortment

Item number	Wood	Price
344500500	Black lacquered	808
344510700	Oak light oil	808

Order configuration

	Oak lacquered	Oak light oil	Oak black lacquered
	837	808	808

Extra charge for

QuickClick glides with or without felt: +24

Certifications

EN 1022:2005, EN 16139:2013 (L1)

Model 3446

Post Armchair Seat upholstered



Designed by Cecilie Manz, 2019

Frame of solid wood. Back and seat of moulded veneer. Veneer core in the same wood as top veneer. Non-removable seat pad upholstered with CMHR or HR foam and covered in fabric or leather.

Modeldetails

0,25 m³ Packaging dimensions:
8,8 kg / 6 kg L: 53 cm W: 57 cm H: 82,5 cm

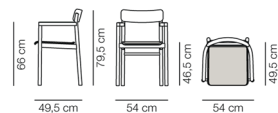

Essential Assortment

Item number	Upholstery	Wood	Price
344650095010700	Leather Max 95, Cognac	Oak light oil	899
344651301000500	Leather Omni 301, Black	Black lacquered	899

Essential variants only delivered with HR foam

Order configuration

	Oak lacquered	Oak light oil	Oak black lacquered
Fabric group 0	858	858	858
Fabric group 1	923	923	923
Fabric group 2	961	961	961
Fabric group 3	996	996	996
Fabric group 4	1.064	1.064	1.064
Fabric group 5	1.151	1.151	1.151
C.O.M. fabric	923	923	923
Leather group 0	863	863	863
Leather group 1	928	928	928
Leather group 2	968	968	968
Leather group 3	1.003	1.003	1.003
Leather group 4	1.040	1.040	1.040
Leather group 5	1.196	1.196	1.196
C.O.M. leather	928	928	928

Fabric consumption: 0,26 m. Leather consumption: 0,45 m²

Extra charge for

QuickClick glides with or without felt: +24

Certifications

EN 1022:2005, EN 16139:2013 (L1)

Recommended upholstery

Fabric group 0	Connect
Fabric group 1	Grand Linen, Remix, Capture, Bardal, Re-wool, Linara, Ruskin, Natural Linen, Erik
Fabric group 2	Hallingdal, Barnum, Loop, Steelcut Trio, Sunniva, Harald, Foss, Fiord, Clay, Savoy
Fabric group 3	Cotil, Divina Melange, Elle, Vidar
Fabric group 4	Grand Mohair, Sisu, Safire
Fabric group 5	Gentle
Leather group 0	Vice
Leather group 1	Omni
Leather group 2	Primo, Trace
Leather group 3	Max
Leather group 4	Nubuck, Organic, Vegeta, Cera

Model 3237

The Spanish Dining Chair



Designed by Børge Mogensen, 1964

Chair with frame of solid wood. Seat and back in vegetable tanned saddle leather with metal buckles. Leather seat has canvas backing. Saddle straps can be tightened as the leather expands through use.

Model details

0,3 m³ Packaging dimensions:
9,5 kg / 7,7 kg L: 54 cm W: 60,5 cm H: 99 cm

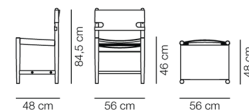

Essential Assortment

Item number	Upholstery	Wood	Price
323710750502	Leather, cognac	Oak light oil	2.083
323710350500	Leather, natural	Oak soap	2.249
323710950501	Leather, black	Smoked oak, oiled	2.333

Order configuration

	Oak soap	Oak oiled	Oak light oil	Oak black lacquered	Smoked oak, oiled
Natural leather	2.249	2.372	2.372	2.372	2.728
Black leather	2.193	2.193	2.193	2.193	2.333
Cognac leather	2.193	2.193	2.083	2.193	2.522

Extra charge for

QuickClick glides with or without felt (R3237): +24

Certifications

EN 1022:2005, EN 16139:2013 (L2)

Model 3238

The Spanish Dining Chair Armchair



Designed by Børge Mogensen, 1964

Armchair with frame of solid wood. Seat and back in vegetable tanned saddle leather with metal buckles. Leather seat has canvas backing. Saddle straps can be tightened as the leather expands through use.

Modeldetails

0,3 m³ Packaging dimensions:
10 kg / 8,9 kg L: 53 cm W: 69 cm H: 83 cm

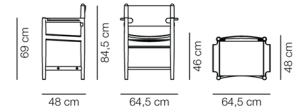

Essential Assortment

Item number	Upholstery	Wood	Price
323810750502	Leather, cognac	Oak light oil	2.249
323810350500	Leather, natural	Oak soap	2.499
323810950501	Leather, black	Smoked oak, oiled	2.583

Order configuration

	Oak soap	Oak oiled	Oak light oil	Oak black lacquered	Smoked oak, oiled
Natural leather	2.499	2.587	2.587	2.587	3.124
Black leather	2.393	2.393	2.393	2.393	2.583
Cognac leather	2.393	2.393	2.249	2.393	2.751

Extra charge for

QuickClick glides with or without felt (R3237): +24

**Model
P3237**

The Spanish Dining Chair Accs.
Leather set for 3237 / 3238

Designed by Børge Mogensen

Seat and back in vegetable tanned saddle leather with metal buckles. Leather seat has canvas backing. Saddle straps can be tightened as the leather expands through use.

Order configuration

Natural leather	Black leather	Cognac leather
1.574	1.417	1.417

Model 3050

Søborg Wood base Chair Wooden seat



Designed by Børge Mogensen, 1950

Wooden side chair. Frame of solid wood, seat and back of moulded plywood. Interchangeable seat and back mounted with black metal screws. Mounted with plastic glides.

Modeldetails

0,4 m³ Packaging dimensions:
7,6 kg / 5 kg L: 58 cm W: 62 cm H: 97 cm

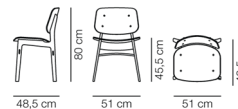

Essential Assortment

Item number	Wood	Price
3050202868	Oak lacquer FSC Mix 70%	549
3050224856	Oak black lacquer, FSC Mix 70%	549
3050162730	Walnut lacquer	683

Essential variants are delivered with plastic glides

Order configuration

	Oak lacquered	Oak oiled	Oak black lacquered	Walnut lacquered
	549	609	549	683

Extra charge for

Glides with felt: +12

Certifications

Oak is FSC® certified
EN 1022:2005, EN 16139:2013 (L2)

Model 3051

Søborg Wood base Chair Seat upholstered



Designed by Børge Mogensen, 1950

Wooden side chair with upholstered seat. Frame of solid wood, seat and back of moulded plywood. Interchangeable seat pad upholstered in CMHR or HR foam with fixed cover in fabric or leather. Interchangeable back mounted with black metal screws. Mounted with plastic glides.

Modeldetails

0,34 m³ Packaging dimensions:
8,2 kg / 5,6 kg L: 58 cm W: 62 cm H: 97 cm

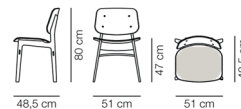

Essential Assortment

Item number	Upholstery	Wood	Price
305120286800219	Hallingdal 130	Oak lacquer FSC Mix 70%	683
305120286851301	Leather Omni 301, Black	Oak lacquer FSC Mix 70%	683
305122485600219	Hallingdal 130	Oak black lacquer, FSC Mix 70%	683
305122485651301	Leather Omni 301, Black	Oak black lacquer, FSC Mix 70%	683
305116273000219	Hallingdal 130	Walnut lacquer	849
305116273051301	Leather Omni 301, Black	Walnut lacquer	849
305120286850095	Leather Max 95, Cognac	Oak lacquer FSC Mix 70%	849

Essential variants are delivered with plastic glides and HR foam

Order configuration

	Oak lacquered	Oak oiled	Oak black lacquered	Walnut lacquered
Fabric group 1	711	711	711	854
Fabric group 2	734	734	734	881
Fabric group 3	762	762	762	914
Fabric group 4	797	797	797	956
Fabric group 5	836	836	836	1.004
C.O.M. fabric	711	711	711	854
Leather group 0	700	700	700	840
Leather group 1	753	753	753	903
Leather group 2	804	804	804	965
Leather group 3	873	873	873	1.048
Leather group 4	960	960	960	1.152
Leather group 5	1.104	1.104	1.104	1.325
C.O.M. leather	753	753	753	903

Fabric consumption: 0,6 m. Leather consumption: 0,54 m²

Extra charge for

Glides with felt: +12

Certifications

Oak is FSC® certified
EN 1022:2005, EN 16139:2013 (L2)

Recommended upholstery

Fabric group 1	Grand Linen, Linara, Bardal, Capture, Remix, Natural Linen, Re-wool, Ruskin, Erik
Fabric group 2	Hallingdal, Harald, Savoy, Clay, Barnum, Sunniva, Steelcut Trio, Fiord, Foss, Loop
Fabric group 3	Vidar, Divina Melange, Elle, Cotil, SheWorks Ribbon
Fabric group 4	Sisu, Grand Mohair, Safire
Fabric group 5	Gentle
Leather group 0	Vice
Leather group 1	Omni
Leather group 2	Primo, Trace
Leather group 3	Max
Leather group 4	Vegeta, Nubuck, Organic, Cera

Model 3052

Søborg Wood base Chair Front upholstered



Designed by Børge Mogensen, 1950

Wooden side chair with upholstered seat and back. Frame of solid wood, seat and back of moulded plywood. Interchangeable seat pad and non-removeable back upholstered in CMHR or HR foam with fixed cover in fabric or leather. Mounted with plastic glides.

Modeldetails

0,34 m³ Packaging dimensions:
9,2 kg / 6,6 kg L: 58 cm W: 62 cm H: 97 cm

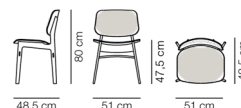

Order configuration

	Oak lacquered	Oak oiled	Oak black lacquered	Walnut lacquered
Fabric group 1	807	807	807	969
Fabric group 2	858	858	858	1.029
Fabric group 3	912	912	912	1.095
Fabric group 4	994	994	994	1.193
Fabric group 5	1.094	1.094	1.094	1.313
C.O.M. fabric	807	807	807	969
Leather group 0	811	811	811	974
Leather group 1	872	872	872	1.047
Leather group 2	972	972	972	1.166
Leather group 3	1.084	1.084	1.084	1.301
Leather group 4	1.193	1.193	1.193	1.431
Leather group 5	1.372	1.372	1.372	1.646
C.O.M. leather	872	872	872	1.047

Fabric consumption: 0,6 m. Leather consumption: 0,9 m²

Extra charge for

Glides with felt: +12

Certifications

Oak is FSC® certified
EN 1022:2005, EN 16139:2013 (L2)

Recommended upholstery

Fabric group 1	Grand Linen, Linara, Bardal, Capture, Remix, Natural Linen, Re-wool, Ruskin, Erik
Fabric group 2	Hallingdal, Harald, Savoy, Clay, Barnum, Sunniva, Steelcut Trio, Fiord, Foss, Loop
Fabric group 3	Vidar, Divina Melange, Elle, Cotil, SheWorks Ribbon
Fabric group 4	Sisu, Grand Mohair, Safire
Fabric group 5	Gentle
Leather group 0	Vice
Leather group 1	Omni
Leather group 2	Primo, Trace
Leather group 3	Max
Leather group 4	Vegeta, Nubuck, Organic, Cera

Model 3060

Søborg Metal base Chair Wooden seat



Designed by Børge Mogensen, 1952

Plywood side chair with steel frame. Interchangeable seat and back mounted with black metal screws. Mounted with plastic glides.

Modeldetails

0,34 m³ Packaging dimensions:
8,6 kg / 6 kg L: 58 cm W: 62 cm H: 97 cm

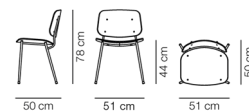

Essential Assortment

Item number	Wood	Frame	Price
3060202400	Oak lacquer FSC Mix 70%	Black	549
3060224400	Oak black lacquer, FSC Mix 70%	Black	549
3060162400	Walnut lacquer	Black	683

Essential variants are delivered with plastic glides

Order configuration

	Oak lacquered	Oak oiled	Oak black lacquered	Walnut lacquered
Black	549	585	549	683
Chrome	585	585	585	702

Other frame colours by quotation (min. 20 pcs.).

Extra charge for

Glides with felt: +12

Certifications

Oak is FSC® certified
EN 1022:2005, EN 16139:2013 (L2)

Model 3061

Søborg Metal base Chair Seat upholstered



Designed by Børge Mogensen, 1952

Plywood side chair with steel frame. Interchangeable seat pad upholstered in CMHR or HR foam with fixed cover in fabric or leather. Interchangeable back mounted with black metal screws. Mounted with plastic glides.

Modeldetails

0,34 m³ Packaging dimensions:
9,5 kg / 6,9 kg L: 58 cm W: 62 cm H: 97 cm

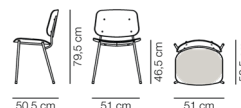

Essential Assortment

Item number	Upholstery	Wood	Frame	Price
306120210000219	Hallingdal 130	Oak lacquer FSC Mix 70%	Chrome	683
306120240051301	Leather Omni 301, Black	Oak lacquer FSC Mix 70%	Black	683
306122410000219	Hallingdal 130	Oak black lacquer, FSC Mix 70%	Chrome	683
306122440051301	Leather Omni 301, Black	Oak black lacquer, FSC Mix 70%	Black	683
306116210000219	Hallingdal 130	Walnut lacquer	Chrome	849
306116240051301	Leather Omni 301, Black	Walnut lacquer	Black	849

Essential variants are delivered with plastic glides and HR foam

Order configuration

Frame: Chrome or black.

	Oak lacquered	Oak oiled	Oak black lacquered	Walnut lacquered
Fabric group 1	716	716	716	857
Fabric group 2	739	739	739	884
Fabric group 3	766	766	766	917
Fabric group 4	801	801	801	959
Fabric group 5	840	840	840	1.006
C.O.M. fabric	716	716	716	857
Leather group 0	705	705	705	844
Leather group 1	757	757	757	906
Leather group 2	809	809	809	968
Leather group 3	877	877	877	1.050
Leather group 4	963	963	963	1.153
Leather group 5	1.106	1.106	1.106	1.325
C.O.M. leather	757	757	757	906

Fabric consumption: 0,6 m. Leather consumption: 0,54 m²

Other frame colours by quotation (min. 20 pcs.).

Extra charge for

Glides with felt: +12

Certifications

Oak is FSC® certified

EN 1022:2005, EN 16139:2013 (L2)

Recommended upholstery

Fabric group 1	Grand Linen, Linara, Bardal, Capture, Remix, Natural Linen, Re-wool, Ruskin, Erik
Fabric group 2	Hallingdal, Harald, Savoy, Clay, Barnum, Sunniva, Steelcut Trio, Fiord, Foss, Loop
Fabric group 3	Vidar, Divina Melange, Elle, Cotil, SheWorks Ribbon
Fabric group 4	Sisu, Grand Mohair, Safire
Fabric group 5	Gentle
Leather group 0	Vice
Leather group 1	Omni
Leather group 2	Primo, Trace
Leather group 3	Max
Leather group 4	Nubuck, Organic, Vegeta, Cera

Model 3062

Søborg Metal base Chair Front upholstered



Designed by Børge Mogensen, 1952

Plywood side chair with steel frame. Interchangeable seat pad and non-removeable back upholstered in CMHR or HR foam with fixed cover in fabric or leather. Mounted with plastic glides.

Modeldetails

0,34 m³ Packaging dimensions:
10,2 kg / 7,6 kg L: 58 cm W: 62 cm H: 97 cm



Essential Assortment

Item number	Upholstery	Wood	Frame	Price
306220210000219056	Hallingdal 130	Oak lacquer FSC Mix 70%	Chrome	766
306220240051301056	Leather Omni 301, Black	Oak lacquer FSC Mix 70%	Black	766
306222410000219056	Hallingdal 130	Oak black lacquer, FSC Mix 70%	Chrome	766
306222440051301056	Leather Omni 301, Black	Oak black lacquer, FSC Mix 70%	Black	766

Essential variants are delivered with plastic glides and HR foam

Order configuration

Frame: Chrome or black.

	Oak lacquered	Oak oiled	Oak black lacquered	Walnut lacquered
Fabric group 1	800	800	800	960
Fabric group 2	850	850	850	1.020
Fabric group 3	904	904	904	1.084
Fabric group 4	985	985	985	1.182
Fabric group 5	1.084	1.084	1.084	1.300
C.O.M. fabric	800	800	800	960
Leather group 0	804	804	804	965
Leather group 1	864	864	864	1.037
Leather group 2	963	963	963	1.156
Leather group 3	1.074	1.074	1.074	1.289
Leather group 4	1.182	1.182	1.182	1.418
Leather group 5	1.359	1.359	1.359	1.631
C.O.M. leather	864	864	864	1.037

Fabric consumption: 0,6 m. Leather consumption: 0,9 m²

Other frame colours by quotation (min. 20 pcs.).

Extra charge for

Glides with felt: +12

Certifications

Oak is FSC® certified

EN 1022:2005, EN 16139:2013 (L2)

Recommended upholstery

Fabric group 1	Grand Linen, Linara, Bardal, Capture, Remix, Natural Linen, Re-wool, Ruskin, Erik
Fabric group 2	Hallingdal, Harald, Savoy, Clay, Barnum, Sunniva, Steelcut Trio, Fiord, Foss, Loop
Fabric group 3	Vidar, Divina Melange, Elle, Cotil, SheWorks Ribbon
Fabric group 4	Sisu, Grand Mohair, Safire
Fabric group 5	Gentle
Leather group 0	Vice
Leather group 1	Omni
Leather group 2	Primo, Trace
Leather group 3	Max
Leather group 4	Nubuck, Organic, Vegeta, Cera

**Model
3090**

Søborg Accessories
Chair suspensions

Chair suspensions in black powder coated steel.

Order configuration

	No template	Template enclosed
Black	69	161

Model 1931



Spine Metal Barstool Fully upholstered

Designed by Space Copenhagen, 2018

Frame of powder coated, welded steel tube and conic steel legs mounted with glider. Seat shell is fully upholstered with CMHR or HR foam on moulded plywood core, covered in fabric or leather. Finished with piping in the same fabric as upholstery or with contrast piping in leather. Cover is non-removable. Please specify counter- or bar height.

Modeldetails

0,34 m³ Packaging dimensions:
13 kg / 10,4 kg L: 56 cm W: 50 cm H: 113,5 cm

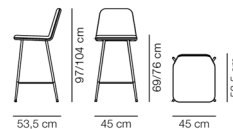

Essential Assortment

Item number	Upholstery	Frame	Seat height	Price
193151301045026490	Leather Omni 301, Black	Black	74 cm	1.049
193158680045026490	Leather Trace 8680, Heritage brown	Black	74 cm	1.224

Essential variants are delivered with plastic glides and HR foam

Order configuration

Frame: Black

Bar or counter height.

Fabric group 0	930
Fabric group 1	1.000
Fabric group 2	1.045
Fabric group 3	1.088
Fabric group 4	1.164
Fabric group 5	1.264
C.O.M. fabric	1.000
Leather group 0	1.073
Leather group 1	1.154
Leather group 2	1.302
Leather group 3	1.439
Leather group 4	1.565
Leather group 5	1.800
C.O.M. leather	1.154

Fabric consumption: 1,1 m. Leather consumption: 1,44 m²

Extra charge for

Glides with felt:	+12
Leather piping for furniture with fabric (88 black, 95 cognac, 90 natural):	+34

Certifications

FSC® certified

EN 1022:2005, EN 16139:2013 (L2)

Recommended upholstery

Fabric group 0	Connect
Fabric group 1	Grand Linen, Linara, Bardal, Capture, Remix, Re-wool, Ruskin, Natural Linen, Erik
Fabric group 2	Hallingdal, Harald, Savoy, Clay, Barnum, Sunniva, Steelcut Trio, Fiord, Foss, Loop
Fabric group 3	Vidar, Divina Melange, Cotil, Elle
Fabric group 4	Sisu, Safire, Grand Mohair
Fabric group 5	Gentle
Leather group 0	Vice
Leather group 1	Omni
Leather group 2	Primo, Trace
Leather group 3	Max
Leather group 4	Nubuck, Organic, Vegeta, Cera

Model 1936

Spine Metal Stool Fully upholstered



Designed by Space Copenhagen, 2018

Frame of powder coated, welded steel tube and conic steel legs mounted with glider. Seat shell is fully upholstered with CMHR or HR foam on plywood core, covered in fabric or leather. Finished with piping in the same fabric as upholstery or with contrast piping in leather. Cover is non-removable. Please specify counter- or bar height.

Model details

0,14 m³ Packaging dimensions:
6,7 kg / 5,9 kg L: 35,5 cm W: 46,5 cm H: 78,5 cm

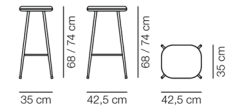

Essential Assortment

Item number	Upholstery	Frame	Seat height	Price
193651301045026490	Leather Omni 301, Black	Black	74 cm	699
193658680045026490	Leather Trace 8680, Heritage brown	Black	74 cm	783

Essential variants are delivered with plastic glides and HR foam

Order configuration

Frame: Black

Bar or counter height.

Fabric group 0	643
Fabric group 1	692
Fabric group 2	730
Fabric group 3	766
Fabric group 4	832
Fabric group 5	916
C.O.M. fabric	692
Leather group 0	712
Leather group 1	765
Leather group 2	855
Leather group 3	939
Leather group 4	1.015
Leather group 5	1.168
C.O.M. leather	765

Fabric consumption: 0,6 m. Leather consumption: 0,88 m²

Extra charge for

Glides with felt:	+12
Leather piping for furniture with fabric (88 black, 95 cognac, 90 natural):	+22

Certifications

FSC® certified
EN 1022:2005, EN 16139:2013 (L2)

Recommended upholstery

Fabric group 0	Connect
Fabric group 1	Grand Linen, Linara, Bardal, Capture, Remix, Re-wool, Ruskin, Natural Linen, Erik
Fabric group 2	Hallingdal, Harald, Savoy, Clay, Barnum, Sunniva, Steelcut Trio, Fiord, Foss, Loop
Fabric group 3	Vidar, Divina Melange, Cotil, Elle
Fabric group 4	Sisu, Safire, Grand Mohair
Fabric group 5	Gentle
Leather group 0	Vice
Leather group 1	Omni
Leather group 2	Primo, Trace
Leather group 3	Max
Leather group 4	Nubuck, Organic, Vegeta, Cera

Model 1721

Spine Wood Chair Front upholstered



Designed by Space Copenhagen, 2011

Chair with legs of solid wood with powder coated aluminum stretcher. Seat shell of plywood with beech core. Front side of seat shell upholstered with CMHR or HR foam and covered in fabric or leather, finished with piping.

Modeldetails

0,3 m³ Packaging dimensions:
10 kg / 8 kg L: 61 cm W: 54 cm H: 83 cm

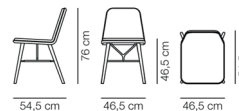

Essential Assortment

Item number	Upholstery	Wood	Price
1721756500110000	Leather Vice 11, Black	Ash, black lacquer - black metal, FSC MIX 70%	1.083
1721756586800000	Leather Trace 8680, Heritage brown	Ash, black lacquer - black metal, FSC MIX 70%	1.249
1721757002070000	Hallingdal 200	Oak lacquer - black metal, FSC Mix 70%	1.499
1721755511120000	Leather Omni 112, Warm grey	Smoked oak stained lacq. -black metal, FSC Mix 70%	1.666

Essential variants only delivered with HR foam

Order configuration

	Oak lacquered	Black ash	Smoked oak stained, lacquered
Fabric group 0	1.444	1.139	1.588
Fabric group 1	1.552	1.225	1.707
Fabric group 2	1.582	1.255	1.741
Fabric group 3	1.630	1.303	1.793
Fabric group 4	1.710	1.383	1.881
Fabric group 5	1.816	1.470	1.998
C.O.M. fabric	1.552	1.225	1.707
Leather group 0	1.476	1.172	1.624
Leather group 1	1.587	1.260	1.746
Leather group 2	1.652	1.325	1.818
Leather group 3	1.713	1.385	1.884
Leather group 4	1.884	1.524	2.072
Leather group 5	2.167	1.752	2.383
C.O.M. leather	1.587	1.260	1.746

Fabric consumption: 0,6 m. Leather consumption: 0,9 m²

Metal parts: Black.

Extra Charge for

QuickClick glides with or without felt: +12

Certifications

FSC® certified
EN 1022:2005, EN 16139:2013 (L1)

Recommended upholstery

Fabric group 0	Connect
Fabric group 1	Grand Linen, Linara, Bardal, Capture, Remix, Re-wool, Ruskin, Natural Linen, Erik
Fabric group 2	Hallingdal, Harald, Savoy, Clay, Barnum, Sunniva, Steelcut Trio, Fiord, Foss, Loop
Fabric group 3	Vidar, Divina Melange, Cotil, Elle
Fabric group 4	Sisu, Safire, Grand Mohair
Fabric group 5	Gentle
Leather group 0	Vice
Leather group 1	Omni
Leather group 2	Primo, Trace
Leather group 3	Max
Leather group 4	Nubuck, Organic, Vegeta, Cera

Model 1731



Spine Wood Barstool Front upholstered

Designed by Space Copenhagen, 2011

Barstool with legs of solid wood with powder coated aluminum stretcher. Seat shell of plywood with beech core. Front side of seat shell is upholstered with CMHR or HR foam and covered in fabric or leather, finished with piping. Please specify counter- or bar height.

Modeldetails

0,34 m³ Packaging dimensions:
13,3 kg / 10,2 kg L: 57 cm W: 53 cm H: 109/120 cm

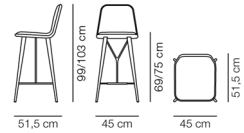

Essential Assortment

Item number	Upholstery	Wood	Seat height	Price
1731756500110400	Leather Vice 11, Black	Ash, black lacquer - black metal, FSC MIX 70%	74 cm	1.166
1731756586800400	Leather Trace 8680, Heritage brown	Ash, black lacquer - black metal, FSC MIX 70%	74 cm	1.333
1731755511120400	Leather Omni 112, Warm grey	Smoked oak stained lacq. -black metal, FSC Mix 70%	74 cm	1.666
1731757002070400	Hallingdal 200	Oak lacquer - black metal, FSC Mix 70%	74 cm	1.666

Essential variants only delivered with HR foam

Order configuration

Bar or counter height.

	Oak lacquered	Black ash	Smoked oak stained, lacquered
Fabric group 0	1.560	1.231	1.716
Fabric group 1	1.678	1.324	1.846
Fabric group 2	1.711	1.357	1.882
Fabric group 3	1.763	1.408	1.939
Fabric group 4	1.849	1.495	2.034
Fabric group 5	1.963	1.589	2.159
C.O.M. fabric	1.678	1.324	1.846
Leather group 0	1.596	1.267	1.755
Leather group 1	1.716	1.362	1.888
Leather group 2	1.786	1.432	1.965
Leather group 3	1.852	1.498	2.037
Leather group 4	2.037	1.647	2.240
Leather group 5	2.342	1.895	2.577
C.O.M. leather	1.716	1.362	1.888

Fabric consumption: 0,6 m. Leather consumption: 0,96 m²

Metal parts: Black.

Extra Charge for

QuickClick glides with or without felt:

+12

Certifications

FSC® certified

EN 1022:2005, EN 16139:2013 (L1)

Recommended upholstery

Fabric group 0	Connect
Fabric group 1	Grand Linen, Linara, Bardal, Capture, Remix, Re-wool, Ruskin, Natural Linen, Erik
Fabric group 2	Hallingdal, Harald, Savoy, Clay, Barnum, Sunniva, Steelcut Trio, Fiord, Foss, Loop
Fabric group 3	Vidar, Divina Melange, Cotil, Elle
Fabric group 4	Sisu, Safire, Grand Mohair
Fabric group 5	Gentle
Leather group 0	Vice
Leather group 1	Omni
Leather group 2	Primo, Trace
Leather group 3	Max
Leather group 4	Nubuck, Organic, Vegeta, Cera

Model 1736

Spine Wood Stool Seat upholstered



Designed by Space Copenhagen, 2014

Legs of solid wood with powder coated aluminum stretcher. Seat shell of plywood with beech core and oak top veneer. Seat is upholstered with CMHR or HR foam and covered in fabric or leather. Please specify counter or bar height.

Model details

0,14 m³ Packaging dimensions:
6,5 kg / 5,74 kg L: 39 cm W: 46 cm H: 72/78 cm

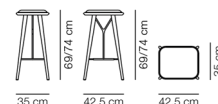

Essential Assortment

Item number	Upholstery	Wood	Seat height	Price
1736756500110400	Leather Vice 11, Black	Ash, black lacquer - black metal, FSC MIX 70%	74 cm	749
1736756586800400	Leather Trace 8680, Heritage brown	Ash, black lacquer - black metal, FSC MIX 70%	74 cm	833
1736757002070400	Hallingdal 200	Oak lacquer - black metal, FSC Mix 70%	74 cm	999
1736755511120400	Leather Omni 112, Warm grey	Smoked oak stained lacq. -black metal, FSC Mix 70%	74 cm	1.083

Essential variants only delivered with HR foam

Order configuration

Bar or counter height.

	Oak lacquered	Black ash	Smoked oak stained, lacquered
Fabric group 0	978	770	1.075
Fabric group 1	1.051	828	1.156
Fabric group 2	1.066	841	1.173
Fabric group 3	1.084	858	1.192
Fabric group 4	1.105	879	1.216
Fabric group 5	1.135	910	1.249
C.O.M. fabric	1.051	828	1.156
Leather group 0	991	782	1.090
Leather group 1	1.066	841	1.172
Leather group 2	1.084	858	1.192
Leather group 3	1.109	883	1.220
Leather group 4	1.220	971	1.342
Leather group 5	1.403	1.117	1.543
C.O.M. leather	1.066	841	1.172

Fabric consumption: 0,57 m. Leather consumption: 0,44 m²

Metal parts: Black.

Extra Charge for

QuickClick glides with or without felt: +12

Certifications

FSC® certified

EN 1022:2005, EN 16139:2013 (L1)

Recommended upholstery

Fabric group 0	Connect
Fabric group 1	Grand Linen, Linara, Bardal, Capture, Remix, Re-wool, Ruskin, Natural Linen, Erik
Fabric group 2	Hallingdal, Harald, Savoy, Clay, Barnum, Sunniva, Steelcut Trio, Fiord, Foss, Loop
Fabric group 3	Vidar, Divina Melange, Cotil, Elle
Fabric group 4	Sisu, Safire, Grand Mohair
Fabric group 5	Gentle
Leather group 0	Vice
Leather group 1	Omni
Leather group 2	Primo, Trace
Leather group 3	Max
Leather group 4	Nubuck, Organic, Vegeta, Cera

Model 1777

Swoon Dining Armchair Wood base



Designed by Space Copenhagen, 2019

Fully upholstered chair with solid wood legs mounted with metal thread. Inner shell in moulded high pressure polyurethane foam, reinforced with a steel frame. Removable seat cushion with CMHR or HR foam with removable cover. Available in fabric or leather. Mounted with plastic glides. Felt glides available.

Modeldetails

0,43 m³ Packaging dimensions:
15 kg / 10,9 kg L: 69,2 cm W: 69,7 cm H: 90 cm

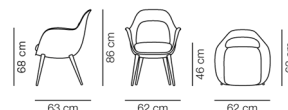

Essential Assortment

Item number	Upholstery	Legs	Price
17770772200005202005	Sunniva 242	Oak lacquer, FSC Mix 70%	1.483
17770773900005162005	Sunniva 717	Walnut lacquer	1.483
17770774500005224005	Sunniva 192	Oak black lacquer FSC Mix 70%	1.483

Essential variants are delivered with plastic glides and HR foam

Order configuration

Legs: Walnut lacquered, oak lacquered, oak oiled, smoked oak stained lacquered or oak black lacquered.

Fabric group 0	1.332
Fabric group 1	1.432
Fabric group 2	1.584
Fabric group 3	1.722
Fabric group 4	1.989
Fabric group 5	2.334
C.O.M. fabric	1.432
Leather group 1	1.653
Leather group 2	1.902
Leather group 3	2.119
Leather group 4	2.347
Leather group 5	2.699
C.O.M. leather	1.653

Fabric consumption: 3 m. Leather consumption: 5 m²

Different fabrics on corpus and cushion upon request.

Certifications

Oak is FSC® certified

Greenguard GOLD certified

EN 1022:2005, EN 16139:2013 (L2)

Recommended upholstery

Fabric group 0	Connect
Fabric group 1	Capture, Re-wool, Bardal, Ruskin, Linara, Remix, Erik
Fabric group 2	Hallingdal, Savoy, Foss, Sunniva, Barnum, Harald, Steelcut Trio, Fiord, Clay, Loop
Fabric group 3	Divina Melange, Vidar, Elle
Fabric group 4	Safire, Sisu, Grand Mohair
Fabric group 5	Gentle
Leather group 1	Omni
Leather group 2	Primo, Trace
Leather group 3	Max
Leather group 4	Vegeta, Nubuck, Organic

Model 1779

Swoon Dining Armchair Swivel base



Designed by Space Copenhagen, 2019

Fully upholstered dining chair with aluminum swivel base. Inner shell in moulded polyurethane foam, reinforced with a steel frame. Removable seat cushion with CMHR or HR foam with removable cover. Available in fabric or leather. Mounted with plastic glides.

Modeldetails

0,43 m³ Packaging dimensions:
22 kg / 16 kg L: 69,2 cm W: 69,7 cm H: 90 cm

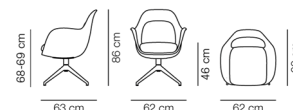

Essential Assortment

Item number	Upholstery	Frame	Price
17790772200005905040	Sunniva 242	Swivel base polished aluminium	1.666
17790773900005451040	Sunniva 717	Swivel base black	1.666
17790774500005451040	Sunniva 192	Swivel base black	1.666

Essential variants are delivered with plastic glides and HR foam

Order configuration

Frame: Polished aluminium or black.

Fabric group 0	1.509
Fabric group 1	1.622
Fabric group 2	1.775
Fabric group 3	1.913
Fabric group 4	2.180
Fabric group 5	2.525
C.O.M. fabric	1.622
Leather group 1	1.844
Leather group 2	2.093
Leather group 3	2.311
Leather group 4	2.537
Leather group 5	2.918
C.O.M. leather	1.844

Fabric consumption: 3 m. Leather consumption: 5 m²

Different fabrics on corpus and cushion upon request.

Extra charge for

Castors, chrome or black: +26

Certifications

Greenguard GOLD certified
EN 1022:2005, EN 16139:2013 (L2)

Recommended upholstery

Fabric group 0	Connect
Fabric group 1	Capture, Re-wool, Bardal, Ruskin, Linara, Remix, Erik
Fabric group 2	Hallingdal, Savoy, Foss, Sunniva, Barnum, Harald, Steelcut Trio, Fiord, Clay, Loop
Fabric group 3	Divina Melange, Vidar, Elle
Fabric group 4	Safire, Sisu, Grand Mohair
Fabric group 5	Gentle
Leather group 1	Omni
Leather group 2	Primo, Trace
Leather group 3	Max
Leather group 4	Vegeta, Nubuck, Organic

Model 3398

Trinidad Chair Wooden seat



Designed by Nanna Ditzel, 1993

Stacking chair. Frame of steel tube, back of moulded plywood with CNC-milled cut-outs. Seat and back mounted with rivets. Mounted with interchangeable plastic glides.

Modeldetails

0,4 m³ Packaging dimensions:
5,8 kg / 4,9 kg L: 71,5 cm W: 53,5 cm H: 103 cm



Essential Assortment

Item number	Wood	Frame	Price
339821200000450016	Beech, lacquer, FSC Mix 70%	Black	458
339827500000100016	Beech nordic blue, FSC Mix 70%	Chrome	458
339828000000100016	Beech khaki green, FSC Mix 70%	Chrome	458
339820200000100016	Oak lacquer FSC Mix 70%	Chrome	541
339822300000100016	Black ash, FSC Mix 70%	Chrome	541
339822600000450016	Walnut lacquer, FSC Mix 70%	Black	541
339829100000551016	Grey oak stained, lacq. FSC Mix 70%	Flint	541
339814400000100016	Oregon pine aged lacquer	Chrome	541

Essential variants are delivered with plastic glides

Order configuration

	Black ash	Beech lacquered / Beech coloured lacquer	Oak lacquered / Oak oiled / Oregon pine aged lacquer	Walnut lacquered	Light grey / Grey	Smoked oak stained, lacquered
Black	556	458	556	541	556	556
Flint	556	488	556	556	556	556
Chrome	541	488	556	556	556	556

Beech coloured lacquer: Nordic blue, Khaki green

Stackable: 8 pcs.

Extra charge for

Glides with felt: +24
Frame brushed stainless steel - each: +177

Certifications

FSC® certified
EN 1022:2005, EN 16139:2013 (L2)

Model 3396

Trinidad Chair Seat upholstered



Designed by Nanna Ditzel, 1993

Wood chair with steel frame and upholstered seat. Frame of steel tube, back of moulded plywood with CNC-milled cut-outs. Fixed interchangeable seat pad upholstered in CMHR or HR foam, covered in fabric or leather. Seat and back mounted with rivets. Mounted with interchangeable plastic glides.

Modeldetails

0,4 m³ Packaging dimensions:
5,9 kg / 5 kg L: 71,5 cm W: 53,5 cm H: 103 cm



Essential Assortment

Item number	Upholstery	Wood	Frame	Price
339621250011450016	Leather Vice 11, Black	Beech, lacquer, FSC Mix 70%	Black	541
339620250011100016	Leather Vice 11, Black	Oak lacquer FSC Mix 70%	Chrome	583
339622350011100016	Leather Vice 11, Black	Black ash, FSC Mix 70%	Chrome	583
339622650011450016	Leather Vice 11, Black	Walnut lacquer, FSC Mix 70%	Black	583
339629150011551016	Leather Vice 11, Black	Grey oak stained, lacq. FSC Mix 70%	Flint	583

Essential variants are delivered with plastic glides and HR foam

Order configuration

Frame: Chrome, black or flint.

	Black ash	Beech lacquered / Beech coloured lacquer	Oak lacquered / Oak oiled / Oregon pine aged lacquer	Walnut lacquered	Light grey / Grey	Smoked oak stained, lacquered
Fabric group 0	794	734	794	794	794	794
Fabric group 1	841	776	841	841	841	841
Fabric group 2	849	785	849	849	849	849
Fabric group 3	857	793	857	857	857	857
Fabric group 4	867	803	867	867	867	867
Fabric group 5	901	834	901	901	901	901
C.O.M. fabric	841	776	841	841	841	841
Leather group 0	815	754	815	815	815	815
Leather group 1	863	797	863	863	863	863
Leather group 2	908	843	908	908	908	908
Leather group 3	942	877	942	942	942	942
Leather group 4	980	912	980	980	980	980
Leather group 5	1.100	1.022	1.100	1.100	1.100	1.100
C.O.M. leather	863	797	863	863	863	863

Fabric consumption: 0,5 m. Leather consumption: 0,44 m²

Beech coloured lacquer: Nordic blue, Khaki green.

Extra charge for

Glides with felt: +24
Frame brushed stainless steel - each: +177

Certifications

FSC® certified
EN 1022:2005, EN 16139:2013 (L2)

Recommended upholstery

Fabric group 0	Connect
Fabric group 1	Grand Linen, Remix, Capture, Bardal, Re-wool, Linara, Ruskin, Natural Linen, Erik
Fabric group 2	Hallingdal, Barnum, Loop, Steelcut Trio, Sunniva, Harald, Foss, Fiord, Clay, Savoy
Fabric group 3	Divina Melange, Vidar, Elle, Cotil
Fabric group 4	Grand Mohair, Sisu, Safire
Fabric group 5	Gentle
Leather group 0	Vice
Leather group 1	Omni
Leather group 2	Primo, Trace
Leather group 3	Max
Leather group 4	Nubuck, Organic, Vegeta, Cera

Model 3399

Trinidad Armchair Wooden seat



Designed by Nanna Ditzel, 1993

Chair with arms, non stackable. Frame of steel tube, seat and back of moulded plywood with CNC-milled cut-outs. Seat and back mounted with rivets. Mounted with interchangeable plastic glides.

Modeldetails

0,46 m³ Packaging dimensions:
7,8 kg / 5,8 kg L: 64 cm W: 71 cm H: 100 cm

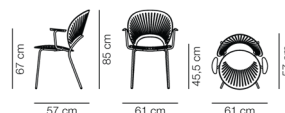

Essential Assortment

Item number	Wood	Frame	Price
339921200000450016	Beech, lacquer, FSC Mix 70%	Black	708
339920200000100016	Oak lacquer FSC Mix 70%	Chrome	791
339922300000100016	Black ash, FSC Mix 70%	Chrome	791
339922600000450016	Walnut lacquer, FSC Mix 70%	Black	791
339929100000551016	Grey oak stained, lacq. FSC Mix 70%	Flint	791

Essential variants are delivered with plastic glides

Order configuration

	Black ash	Beech lacquered / Beech coloured lacquer	Oak lacquered / Oak oiled / Oregon pine aged lacquer	Walnut lacquered	Light grey / Grey	Smoked oak stained, lacquered
Black	811	745	811	811	811	811
Flint	811	745	811	811	811	811
Chrome	791	745	811	811	811	811

Beech coloured lacquer: Nordic blue, Khaki green.

Extra charge for

Glides with felt: +24

Certifications

FSC® certified
EN 1022:2005, EN 16139:2013 (L2)

Model 3397

Trinidad Armchair Seat upholstered



Designed by Nanna Ditzel, 1993

Chair with arms and upholstered seat, non-stackable. Frame of steel tube, seat and back of moulded plywood. Back with CNC-milled cut-outs. Non-removable seat pad upholstered in CMHR or HR foam, covered in fabric or leather. Seat and back mounted with rivets. Mounted with interchangeable plastic glides.

Modeldetails

0,46 m³ Packaging dimensions:
8 kg / 6 kg L: 64 cm W: 71 cm H: 100 cm

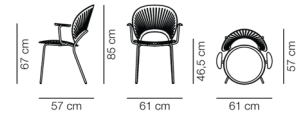

Essential Assortment

Item number	Upholstery	Wood	Frame	Price
339721250011450016	Leather Vice 11, Black	Beech, lacquer, FSC Mix 70%	Black	749
339720250011100016	Leather Vice 11, Black	Oak lacquer FSC Mix 70%	Chrome	833
339722350011100016	Leather Vice 11, Black	Black ash, FSC Mix 70%	Chrome	833
339722650011450016	Leather Vice 11, Black	Walnut lacquer, FSC Mix 70%	Black	833
339729150011551016	Leather Vice 11, Black	Grey oak stained, lacq. FSC Mix 70%	Flint	833

Essential variants are delivered with plastic glides and HR foam

Order configuration

Frame: Chrome, black or flint.

	Black ash	Beech lacquered / Beech coloured lacquered	Oak lacquered / Oak oiled / Oregon pine aged lacquer	Walnut lacquered	Light grey / Grey	Smoked oak stained, lacquered
Fabric group 0	862	796	862	862	862	862
Fabric group 1	927	856	927	927	927	927
Fabric group 2	935	864	935	935	935	935
Fabric group 3	943	873	943	943	943	943
Fabric group 4	947	883	947	947	947	947
Fabric group 5	995	927	995	995	995	995
C.O.M. fabric	927	856	927	927	927	927
Leather group 0	882	805	882	882	882	882
Leather group 1	949	866	949	949	949	949
Leather group 2	995	913	995	995	995	995
Leather group 3	1.031	962	1.031	1.031	1.031	1.031
Leather group 4	1.082	1.010	1.082	1.082	1.082	1.082
Leather group 5	1.245	1.161	1.245	1.245	1.245	1.245
C.O.M. leather	949	866	949	949	949	949

Fabric consumption: 0,5 m. Leather consumption: 0,44 m²

Beech coloured lacquered: Nordic blue, Khaki green.

Extra charge for

Glides with felt: +24

Certifications

FSC® certified
EN 1022:2005, EN 16139:2013 (L2)

Recommended upholstery

Fabric group 0	Connect
Fabric group 1	Grand Linen, Remix, Capture, Bardal, Re-wool, Linara, Ruskin, Natural Linen, Erik
Fabric group 2	Hallingdal, Barnum, Loop, Steelcut Trio, Sunniva, Harald, Foss, Fiord, Clay, Savoy
Fabric group 3	Divina Melange, Vidar, Elle, Cotil
Fabric group 4	Grand Mohair, Sisu, Safire
Fabric group 5	Gentle
Leather group 0	Vice
Leather group 1	Omni
Leather group 2	Primo, Trace
Leather group 3	Max
Leather group 4	Nubuck, Organic, Vegeta, Cera

Model 3400



Trinidad Barstool Wooden seat

Designed by Nanna Ditzel, 1998

Barstool. Frame of steel tube, back of moulded plywood with CNC-milled cut-outs. Seat and back mounted with rivets. Mounted with interchangeable plastic glides.

Modeldetails

0,33 m³ Packaging dimensions:
9 kg / 5,6 kg L: 56,5 cm W: 52 cm H: 114 cm

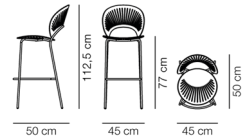

Order configuration

	Black ash	Beech lacquered / Beech coloured lacquer	Oak lacquered / Oak oiled / Oregon pine aged lacquer	Walnut lacquered	Light grey / Grey	Smoked oak stained, lacquered
Black	909	886	909	909	909	909
Flint	909	886	909	909	909	909
Chrome	909	886	909	909	909	909

Beech coloured lacquer: Nordic blue, Khaki green.

Extra charge for

Glides with felt: +24

Certifications

FSC® certified

Model 3401



Trinidad Barstool Seat upholstered

Designed by Nanna Ditzel, 1998

Barstool with upholstered seat. Frame of steel tube, back of moulded plywood, with CNC-milled cut-outs. Non-removable seat pad upholstered in CMHR or HR foam, covered in fabric or leather. Seat and back mounted with rivets. Mounted with interchangeable plastic glides.

Model details

0,33 m³ Packaging dimensions:
10 kg / 6,6 kg L: 56,5 cm W: 52 cm H: 114 cm

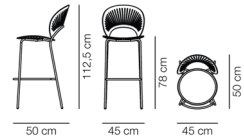

Order configuration

Frame: Chrome, black or flint.

	Black ash	Beech lacquered / Beech coloured lacquer	Oak lacquered / Oak oiled / Oregon pine aged lacquer	Walnut lacquered	Light grey / Grey	Smoked oak stained, lacquered
Fabric group 0	902	885	902	902	902	902
Fabric group 1	970	951	970	970	970	970
Fabric group 2	978	959	978	978	978	978
Fabric group 3	986	967	986	986	986	986
Fabric group 4	995	976	995	995	995	995
Fabric group 5	1.045	1.025	1.045	1.045	1.045	1.045
C.O.M. fabric	970	951	970	970	970	970
Leather group 0	1.003	988	1.003	1.003	1.003	1.003
Leather group 1	1.079	1.063	1.079	1.079	1.079	1.079
Leather group 2	1.124	1.109	1.124	1.124	1.124	1.124
Leather group 3	1.155	1.138	1.155	1.155	1.155	1.155
Leather group 4	1.213	1.195	1.213	1.213	1.213	1.213
Leather group 5	1.395	1.375	1.395	1.395	1.395	1.395
C.O.M. leather	1.079	1.063	1.079	1.079	1.079	1.079

Fabric consumption: 0,5 m. Leather consumption: 0,44 m²

Beech coloured lacquer: Nordic blue, Khaki green.

Extra charge for

Glides with felt: +24

Certifications

FSC® certified

Recommended upholstery

Fabric group 0	Connect
Fabric group 1	Grand Linen, Linara, Bardal, Capture, Remix, Natural Linen, Re-wool, Ruskin, Erik
Fabric group 2	Hallingdal, Harald, Savoy, Clay, Barnum, Sunniva, Steelcut Trio, Fiord, Foss, Loop
Fabric group 3	Vidar, Divina Melange, Elle, Cotil
Fabric group 4	Sisu, Grand Mohair, Safire
Fabric group 5	Gentle
Leather group 0	Vice
Leather group 1	Omni
Leather group 2	Primo, Trace
Leather group 3	Max
Leather group 4	Vegeta, Nubuck, Organic, Cera

**Model
3288**

Trinidad Accessories
Coupling device

Modeldetails

⌘ 0,1 kg /
0,08 kg

Order configuration

For model 3396
and 3398

17

**Model
8101**

Trinidad Accessories
Transport trolley

Modeldetails

0,49 m³ Packaging dimensions:
15 kg / L: 69 cm W: 51,2 cm H: 140 cm
9 kg

Transport trolley for stackable Trinidad chair. Black powder coated steel.

Order configuration

For 2 x 8 chairs

Black	827
-------	-----

**Model
8102**

Trinidad Accessories
Chair suspensions

Modeldetails

⌘ 0,5 kg /
0,5 kg

Chair suspensions in black powder coated steel.

Order configuration

	No template	Template enclosed
Black	83	196

Model 3340

Yksi Armchair Wooden seat



Designed by Thau & Kallio, 2018

Chair with frame in solid wood. Seat and arm/backrest in moulded plywood with beech core and oak top veneer.

Modeldetails

0,26 m³ Packaging dimensions:
8 kg / L: 54 cm W: 59 cm H: 82 cm
5,5 kg

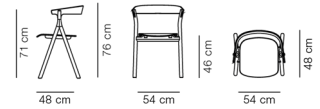

Essential Assortment

Item number	Wood	Price
334000600	Oak black lacquered	641
334010200	Oak lacquer	641

Stackable: 2 pcs.

Extra charge for

QuickClick glides with or without felt (R3340G): +24

Certifications

EN 1022:2005, EN 16139:2013 (L1)

Model 3341

Yksi Armchair Seat upholstered



Designed by Thau & Kallio, 2018

Chair with frame in solid wood. Arm/backrest in moulded plywood with beech core and oak top veneer. Seat in moulded plywood padded with CMHR or HR foam and upholstered in fabric or leather.

Modeldetails

0,26 m³ Packaging dimensions:
8,5 kg / 6 kg L: 54 cm W: 59 cm H: 82 cm

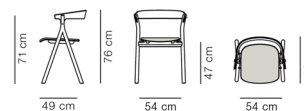

Essential Assortment

Item number	Wood	Upholstery	Price
334100650011000	Oak black lacquered	Leather Vice 11, Black	732
334110250011000	Oak lacquer	Leather Vice 11, Black	732

Essential variants only delivered with HR foam

Order configuration

	Oak lacquered	Oak black lacquered
Fabric group 0	751	777
Fabric group 1	808	835
Fabric group 2	851	878
Fabric group 3	890	917
Fabric group 4	962	989
Fabric group 5	1.054	1.082
C.O.M. fabric	808	835
Leather group 0	753	778
Leather group 1	810	836
Leather group 2	860	887
Leather group 3	906	934
Leather group 4	951	980
Leather group 5	1.094	1.128
C.O.M. leather	810	836

Fabric consumption: 0,5 m. Leather consumption: 0,6 m²

Extra charge for

QuickClick glides with or without felt (R3340G): +24

Certifications

EN 1022:2005, EN 16139:2013 (L1)

Recommended upholstery

Fabric group 0	Connect
Fabric group 1	Grand Linen, Linara, Bardal, Capture, Remix, Re-wool, Ruskin, Natural Linen, Erik
Fabric group 2	Hallingdal, Harald, Savoy, Clay, Barnum, Sunniva, Steelcut Trio, Fiord, Foss, Loop
Fabric group 3	Vidar, Divina Melange, Elle, Cotil
Fabric group 4	Sisu, Grand Mohair, Safire
Fabric group 5	Gentle
Leather group 0	Vice
Leather group 1	Omni
Leather group 2	Primo, Trace
Leather group 3	Max
Leather group 4	Nubuck, Vegeta, Organic, Cera

Lounge Chairs

Model 6540

A-Chair Wood base



Designed by Jens Risom, 1961

Fully upholstered lounge chair with separate seat cushion. Inner frame of wood, upholstered in CMHR or HR foam, covered in fabric or leather. Fixed legs of solid wood. Removable seat cushion has a foam core in feather wrap. Cover on seat cushion is removable.

Modeldetails

0,65 m³ Packaging dimensions:
28 kg / 20 kg L: 90 cm W: 80 cm H: 90 cm

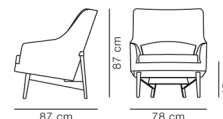

Essential Assortment

Item number	Upholstery	Wood	Price
654019300016200	Re-Wool 198	Walnut lacquer	2.916
654019309010200	Re-Wool 358	Oak lacquer	2.916
654019311010200	Re-Wool 128	Oak lacquer	2.916
654001671016200	Loop 33	Walnut lacquer	3.333

Essential variants only delivered with HR foam

Order configuration

	Oak lacquered	Oak oiled	Oak black lacquered	Walnut lacquered
Fabric group 1	3.048	3.151	3.048	3.360
Fabric group 2	3.310	3.414	3.310	3.606
Fabric group 3	3.546	3.650	3.546	3.827
Fabric group 4	4.005	4.109	4.005	4.256
Fabric group 5	4.598	4.702	4.598	4.811
C.O.M. fabric	3.048	3.151	3.048	3.360
Leather group 1	3.970	4.073	3.970	4.223
Leather group 2	4.639	4.742	4.639	4.849
Leather group 3	5.221	5.325	5.221	5.394
C.O.M. leather	3.970	4.073	3.970	4.223
Leather 90 natural	5.833	5.936	5.833	5.966

Fabric consumption: 3,1 m. Leather consumption: 5,8 m²

Extra charge for

QuickClick glides with or without felt: +12

Certifications

EN 1022:2005, EN 16139:2013 (L2)

Recommended upholstery

Fabric group 1	Grand Linen, Remix, Capture, Bardal, Re-wool, Linara, Ruskin, Natural Linen, Erik
Fabric group 2	Hallingdal, Barnum, Loop, Steelcut Trio, Sunniva, Foss, Fiord, Clay
Fabric group 3	Divina Melange, Elle, Vidar, Cotil
Fabric group 4	Grand Mohair, Sisu, Safire
Fabric group 5	Gentle
Leather group 1	Omni
Leather group 2	Trace
Leather group 3	Max
Leather group 4	Organic, Vegeta, Cera

Model 6542

A-Chair Metal base



Designed by Jens Risom, 1961

Fully upholstered lounge chair with separate seat cushion. Inner frame of wood, upholstered in CMHR or HR foam, covered in fabric or leather. Fixed legs of chromed or powder coated steel tubes. Removable seat cushion has foam core in feather wrap. Cover on seat cushion is removable.

Modeldetails

0,65 m³ Packaging dimensions:
29 kg / 21 kg L: 90 cm W: 80 cm H: 90 cm

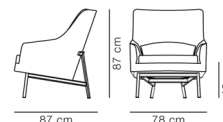

Essential Assortment

Item number	Upholstery	Frame	Price
654219300040012	Re-Wool 198	Black	2.916
654219309040012	Re-Wool 358	Black	2.916
654219311040012	Re-Wool 128	Black	2.916
654201671040012	Loop 33	Black	3.166

Essential variants only delivered with HR foam

Order configuration

Frame: Black or matt chrome.

Fabric group 1	3.048
Fabric group 2	3.310
Fabric group 3	3.546
Fabric group 4	4.005
Fabric group 5	4.598
C.O.M. fabric	3.048
Leather group 1	3.970
Leather group 2	4.639
Leather group 3	5.221
C.O.M. leather	3.970
Leather 90 natural	5.833

Fabric consumption: 3,1 m. Leather consumption: 5,8 m²

Extra charge for

QuickClick glides with felt: +12

Certifications

EN 1022:2005, EN 16139:2013 (L2)

Recommended upholstery

Fabric group 1	Grand Linen, Remix, Capture, Bardal, Re-wool, Linara, Ruskin, Natural Linen, Erik
Fabric group 2	Hallingdal, Barnum, Loop, Steelcut Trio, Sunniva, Foss, Fiord, Clay
Fabric group 3	Divina Melange, Elle, Vidar, Cotil
Fabric group 4	Grand Mohair, Sisu, Safire
Fabric group 5	Gentle
Leather group 1	Omni
Leather group 2	Trace
Leather group 3	Max
Leather group 4	Organic, Vegeta, Cera

Model 2031

The Canvas Chair Lounge chair



Designed by Børge Mogensen, 1970

Lounge chair of solid wood and canvas. Interchangeable seat and back made of 100% linen canvas.

Modeldetails

0,5 m³ Packaging dimensions:
13,8 kg / 8,3 kg L: 81 cm W: 72 cm H: 85 cm

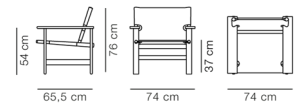

Essential Assortment

Item number	Seat and back	Wood	Price
20312062000	Natural canvas	Oak light oil, FSC Mix 70%	1.916
20312251000	Black canvas	Oak black lacquer, FSC Mix 70%	1.916
20312071000	Black canvas	Smoked oak, oiled, FSC Mix 70%	2.083

Order configuration

Oak soap Canvas natural	Oak light oil Canvas natural	Oak black lacquered Canvas black	Smoked oak, oiled Canvas black
1.968	1.916	1.916	2.083

Certifications

FSC® certified

BS 5852:Part 1:1979 - Match flame equivalent, BS 5852:Part 1:1979 - Smouldering cigarette, EN 1022:2005, EN 16139:2013 (L2)

Model P2031

The Canvas Chair Accessories Seat cushion

Model details



Designed by Børge Mogensen

Loose seat cushion for The Canvas Chair in HR or CMHR-foam. Seat cushion has removable cover.

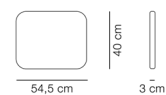

Essential Assortment

Item number	Upholstery	Price
P2031499980	Natural canvas	208
P2031499990	Black canvas	208

Essential variants only delivered with HR foam

Order configuration

Leather group 0	375
Leather group 1	403
Leather group 2	471
Leather group 3	540
Leather group 4	612
Leather group 5	704
C.O.M. leather	403
Canvas black or natural	208

Recommended upholstery

Leather group 0	Vice
Leather group 1	Omni
Leather group 2	Primo, Trace
Leather group 3	Max
Leather group 4	Nubuck, Vegeta, Organic, Cera

**Model
R2031**

The Canvas Chair Accessories
Complete canvas set for 2031

Designed by Børge Mogensen

Complete canvas set in 100% linen canvas.

Order configuration

Canvas naturel	Canvas black
689	689

Model 5000



Corona Chair Swivel base

Designed by Poul M. Volther, 1964

Swivel lounge chair. Seat and back of four separate pads of moulded cold cured foam, fully upholstered in fabric or leather. Spring steel swivel base and frame. Mounted with natural fibre glides, as an alternative to felt.

Modeldetails

0,56 m³ Packaging dimensions:
37 kg / 29 kg L: 95/60 cm W: 85/55 cm H: 52/29 cm

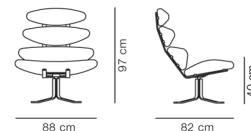

Essential Assortment

Item number	Upholstery	Frame	Price
500051301050000	Leather Omni 301, Black	Brushed steel	4.999
500050095050000	Leather Max 95, Cognac	Brushed steel	5.833

Essential variants only delivered with HR foam

Order configuration

	Black	Brushed steel
Fabric group 1	4.676	4.676
Fabric group 2	4.791	4.791
Fabric group 3	4.846	4.846
Fabric group 4	5.013	5.013
Fabric group 5	6.015	6.015
C.O.M. fabric	4.676	4.676
Leather group 1	5.882	5.882
Leather group 2	6.217	6.217
Leather group 3	6.737	6.737
Leather group 4	6.995	6.995
Leather group 5	8.045	8.045
C.O.M. leather	5.882	5.882

Fabric consumption: 2 m. Leather consumption: 5 m²

Recommended upholstery

Fabric group 1	Grand Linen, Remix, Capture, Bardal, Re-wool, Linara, Ruskin, Natural Linen, Erik
Fabric group 2	Hallingdal, Barnum, Loop, Steelcut Trio, Sunniva, Harald, Foss, Fiord, Clay
Fabric group 3	Divina Melange, Elle, Vidar, Cotil
Fabric group 4	Grand Mohair, Sisu, Safire
Fabric group 5	Gentle
Leather group 1	Omni
Leather group 2	Primo, Trace
Leather group 3	Max
Leather group 4	Nubuck, Vegeta, Organic, Cera

Model 5002

Corona Ottoman



Designed by Poul M. Volther, 1964

Ottoman of cold cured foam reinforced with steel, fully upholstered in fabric or leather. Spring steel base and frame. Mounted with natural fibre glides, as an alternative to felt.

Modeldetails

0,17 m³ Packaging dimensions:
12 kg / 10 kg L: 75 cm W: 46 cm H: 47 cm



Essential Assortment

Item number	Upholstery	Frame	Price
500251301050000	Leather Omni 301, Black	Brushed steel	2.083
500250095050000	Leather Max 95, Cognac	Brushed steel	2.333

Essential variants only delivered with HR foam

Order configuration

	Black	Brushed steel
Fabric group 1	1.789	1.789
Fabric group 2	1.837	1.837
Fabric group 3	1.860	1.860
Fabric group 4	1.928	1.928
Fabric group 5	2.314	2.314
C.O.M. fabric	1.789	1.789
Leather group 1	2.191	2.191
Leather group 2	2.305	2.305
Leather group 3	2.484	2.484
Leather group 4	2.572	2.572
Leather group 5	2.958	2.958
C.O.M. leather	2.191	2.191

Fabric consumption: 0,85 m. Leather consumption: 2,5 m²

Recommended upholstery

Fabric group 1	Grand Linen, Remix, Capture, Bardal, Re-wool, Linara, Ruskin, Natural Linen, Erik
Fabric group 2	Hallingdal, Barnum, Loop, Steelcut Trio, Sunniva, Harald, Foss, Fiord, Clay
Fabric group 3	Divina Melange, Elle, Vidar, Cotil
Fabric group 4	Grand Mohair, Sisu, Safire
Fabric group 5	Gentle
Leather group 1	Omni
Leather group 2	Primo, Trace
Leather group 3	Max
Leather group 4	Nubuck, Vegeta, Organic, Cera

Model 2631

Ditzel Lounge Chair Wood base, Sheepskin



Designed by Nanna Ditzel, 1953

Upholstered lounge chair with legs of solid wood mounted with metal thread. Body moulded in cold cured foam reinforced with steel frame. Upholstered in sheepskin. Cover is non-removable.

Modeldetails

0,72 m³ Packaging dimensions:
28 kg / 15 kg L: 88 cm W: 80 cm H: 77 cm



Essential Assortment

Item number	Upholstery	Legs	Price
2631499800000102020	Sheepskin Moonlight	Oak lacquer, FSC Mix 70%	3.091
2631499800000101620	Sheepskin Moonlight	Walnut lacquer	3.091

Essential variants only delivered with HR foam

Order configuration

	Oak lacquered	Oak oiled	Smoked oak stained, lacquered	Oak black lacquered	Walnut lacquered
Sheepskin	3.091	3.447	3.447	3.447	3.091

Fabric consumption: 2,5 m. Leather consumption: 4 m²

Certifications

Oak is FSC® certified
Greenguard GOLD certified
EN 1022:2005, EN 16139:2013 (L2)

Model 2632

Ditzel Lounge Chair Wood base



Designed by Nanna Ditzel, 1953

Legs of solid wood mounted with metal thread. Body moulded in cold cured foam reinforced with steel frame and topped with batting. Upholstered in fabric or leather with piping in the same upholstery. Available with piping in leather when upholstered in fabric. Cover is non-removable.

Modeldetails

0,72 m³ Packaging dimensions:
27 kg / 14 kg L: 88 cm W: 80 cm H: 77 cm



Essential Assortment

Item number	Upholstery	Legs	Price
26320026890020500	Hallingdal 116	Oak oil, FSC Mix 70%	1.708

Order configuration

	Oak lacquered	Oak oiled	Smoked oak stained, lacquered	Oak black lacquered	Walnut lacquered
Fabric group 1	1.652	1.652	1.652	1.652	1.652
Fabric group 2	1.816	1.816	1.816	1.816	1.816
Fabric group 3	1.963	1.963	1.963	1.963	1.963
Fabric group 4	2.250	2.250	2.250	2.250	2.250
Fabric group 5	2.620	2.620	2.620	2.620	2.620
C.O.M. fabric	1.652	1.652	1.652	1.652	1.652
Leather group 1	2.180	2.180	2.180	2.180	2.180
Leather group 2	2.505	2.505	2.505	2.505	2.505
Leather group 3	2.832	2.832	2.832	2.832	2.832
Leather group 4	3.176	3.176	3.176	3.176	3.176
Leather group 5	3.653	3.653	3.653	3.653	3.653
C.O.M. leather	2.180	2.180	2.180	2.180	2.180

Fabric consumption: 2,5 m. Leather consumption: 4 m²

Two additional seams on front and back when upholstered in leather.

Possibility of upholstery in other textiles in addition to recommended upholstery, two extra seams on front and back can occur.

When upholstered in fabric, piping is available in leather: 88 Black, 95 Cognac or 90 Natural.

Certifications

Oak is FSC® certified

EN 1022:2005, EN 16139:2013 (L2)

Recommended upholstery

Fabric group 1	Bardal, Capture, Ruskin
Fabric group 2	Hallingdal, Clay, Barnum
Fabric group 3	Divina Melange, Elle
Fabric group 4	Sisu
Fabric group 5	Gentle
Leather group 1	Omni
Leather group 2	Primo, Trace
Leather group 3	Max
Leather group 4	Nubuck, Vegeta, Organic

Model 4850

Eyes Lounge Chair 4-Leg tube base



Designed by Foersom & Hiort-Lorenzen, 2011

Fully upholstered shell in cold cured foam reinforced with a steel frame, covered in fabric or leather. Cover is non-removable. Base of steel tube mounted with plastic glides. Felt glides available.

Modeldetails

0,47 m³ Packaging dimensions:
19 kg / L: 77 cm W: 76 cm H: 80 cm
16 kg

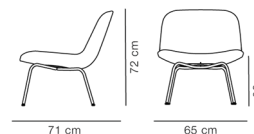

Order configuration

	Black	Brushed stainless steel
Fabric group 0	963	963
Fabric group 1	1.035	1.035
Fabric group 2	1.137	1.137
Fabric group 3	1.187	1.187
Fabric group 4	1.333	1.333
Fabric group 5	1.600	1.600
C.O.M. fabric	1.035	1.035
Leather group 0	1.620	1.620
Leather group 1	1.742	1.742
Leather group 2	1.951	1.951
Leather group 3	2.276	2.276
Leather group 4	2.437	2.437
Leather group 5	2.803	2.803
C.O.M. leather	1.742	1.742

Fabric consumption: 1,5 m. Leather consumption: 3 m²

As standard delivered without decoration buttons.

Extra charge for

Buttons in the same upholstery as the chair or in selected leather: +103

Certifications

EN 1022:2005, EN 16139:2013 (L1)

Recommended upholstery

Fabric group 0	Connect
Fabric group 1	Capture, Re-wool, Remix, Bardal, Linara, Ruskin, Natural Linen, Erik
Fabric group 2	Hallingdal, Sunniva, Barnum, Fiord, Steelcut Trio, Foss, Loop, Clay
Fabric group 3	Vidar, Divina Melange, Elle, Cotil 863
Fabric group 4	Safire, Sisu
Fabric group 5	Gentle
Leather group 0	Vice
Leather group 1	Omni
Leather group 2	Primo, Trace
Leather group 3	Max
Leather group 4	Vegeta, Organic, Nubuck, Cera

Model 4854

Eyes Lounge Chair Wood base



Designed by Foersom & Hiort-Lorenzen, 2011

Fully upholstered shell in cold cured foam reinforced with a steel frame, covered in fabric or leather. Cover is non-removable. Base of solid wood. Glides not included.

Modeldetails

0,5 m³ Packaging dimensions:
13 kg / 10 kg L: 77 cm W: 76 cm H: 80 cm

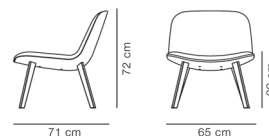

Essential Assortment

Item number	Upholstery	Frame	Price
4854193000006000200	Re-Wool 198	Oak black lacquer	958
48541931100006000100	Re-Wool 128	Oak lacquer	958
48544452400006000100	Gentle 873	Oak lacquer	1.483

Essential variants only delivered with HR foam

Order configuration

	Oak lacquered	Oak black lacquered	Smoked oak stained
Fabric group 0	963	963	963
Fabric group 1	1.035	1.035	1.035
Fabric group 2	1.137	1.137	1.137
Fabric group 3	1.187	1.187	1.187
Fabric group 4	1.333	1.333	1.333
Fabric group 5	1.600	1.600	1.600
C.O.M. fabric	1.035	1.035	1.035
Leather group 0	1.620	1.620	1.620
Leather group 1	1.742	1.742	1.742
Leather group 2	1.951	1.951	1.951
Leather group 3	2.276	2.276	2.276
Leather group 4	2.437	2.437	2.437
Leather group 5	2.803	2.803	2.803
C.O.M. leather	1.742	1.742	1.742

Fabric consumption: 1,5 m. Leather consumption: 3 m²

As standard delivered without decoration buttons.

Extra charge for

Buttons in the same upholstery as the chair or in selected leather: +103

Certifications

EN 1022:2005, EN 16139:2013 (L1)

Recommended upholstery

Fabric group 0	Connect
Fabric group 1	Capture, Re-wool, Remix, Bardal, Linara, Ruskin, Natural Linen, Erik
Fabric group 2	Hallingdal, Sunniva, Barnum, Fiord, Steelcut Trio, Foss, Loop, Clay
Fabric group 3	Vidar, Divina Melange, Elle, Cotil 863
Fabric group 4	Safire, Sisu
Fabric group 5	Gentle
Leather group 0	Vice
Leather group 1	Omni
Leather group 2	Primo, Trace
Leather group 3	Max
Leather group 4	Vegeta, Organic, Nubuck, Cera

Model 4856

Eyes Lounge Armchair Wood base



Designed by Foersom & Hiert-Lorenzen, 2011

Fully upholstered shell in cold cured foam reinforced with a steel frame, covered in fabric or leather. Cover is non-removable. Base and armrests of solid wood. Glides not included.

Modeldetails

0,5 m³ Packaging dimensions:
14 kg / 11 kg L: 77 cm W: 76 cm H: 80 cm

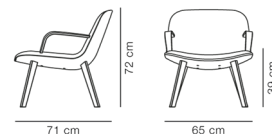

Essential Assortment

Item number	Upholstery	Frame	Price
4856193000006000200	Re-Wool 198	Oak black lacquer	1.574
48561931100006000100	Re-Wool 128	Oak lacquer	1.574
48564452400006000100	Gentle 873	Oak lacquer	2.016

Essential variants only delivered with HR foam

Order configuration

	Oak lacquered	Oak black lacquered	Smoked oak stained
Fabric group 0	1.521	1.521	1.521
Fabric group 1	1.636	1.636	1.636
Fabric group 2	1.738	1.738	1.738
Fabric group 3	1.787	1.787	1.787
Fabric group 4	1.934	1.934	1.934
Fabric group 5	2.320	2.320	2.320
C.O.M. fabric	1.636	1.636	1.636
Leather group 0	2.178	2.178	2.178
Leather group 1	2.342	2.342	2.342
Leather group 2	2.551	2.551	2.551
Leather group 3	2.876	2.876	2.876
Leather group 4	3.038	3.038	3.038
Leather group 5	3.493	3.493	3.493
C.O.M. leather	2.342	2.342	2.342

Fabric consumption: 1,5 m. Leather consumption: 3 m²

As standard delivered without decoration buttons.

Extra charge for

Buttons in the same upholstery as the chair or in selected leather: +103

Recommended upholstery

Fabric group 0	Connect
Fabric group 1	Capture, Re-wool, Remix, Bardal, Linara, Ruskin, Natural Linen, Erik
Fabric group 2	Hallingdal, Sunniva, Barnum, Fiord, Steelcut Trio, Foss, Loop, Clay
Fabric group 3	Vidar, Divina Melange, Elle, Cotil 863
Fabric group 4	Safire, Sisu
Fabric group 5	Gentle
Leather group 0	Vice
Leather group 1	Omni
Leather group 2	Primo, Trace
Leather group 3	Max
Leather group 4	Vegeta, Organic, Nubuck, Cera

Model 4858

Eyes Lounge Chair Swivel base



Designed by Foersom & Hiort-Lorenzen, 2011

Fully upholstered shell in cold cured foam reinforced with a steel frame covered in fabric or leather. Cover is non-removable. 4-point swivel base in polished or powder coated aluminium. Mounted with reversible plastic glides which can be changed to felt when reversed.

Modeldetails

0,5 m³ Packaging dimensions:
19 kg / 16 kg L: 77 cm W: 76 cm H: 80 cm



Order configuration

	Black	Polished aluminium
Fabric group 0	1.017	1.017
Fabric group 1	1.094	1.094
Fabric group 2	1.202	1.202
Fabric group 3	1.254	1.254
Fabric group 4	1.409	1.409
Fabric group 5	1.691	1.691
C.O.M. fabric	1.094	1.094
Leather group 0	1.712	1.712
Leather group 1	1.841	1.841
Leather group 2	2.061	2.061
Leather group 3	2.405	2.405
Leather group 4	2.575	2.575
Leather group 5	2.961	2.961
C.O.M. leather	1.841	1.841

Fabric consumption: 1,5 m. Leather consumption: 3 m²

As standard delivered without decoration buttons.

Extra charge for

Buttons in the same upholstery as the chair or in selected leather: +103

Recommended upholstery

Fabric group 0	Connect
Fabric group 1	Capture, Re-wool, Remix, Bardal, Linara, Ruskin, Natural Linen, Erik
Fabric group 2	Hallingdal, Sunniva, Barnum, Fiord, Steelcut Trio, Foss, Loop, Clay
Fabric group 3	Vidar, Divina Melange, Elle, Cotil 863
Fabric group 4	Safire, Sisu
Fabric group 5	Gentle
Leather group 0	Vice
Leather group 1	Omni
Leather group 2	Primo, Trace
Leather group 3	Max
Leather group 4	Vegeta, Organic, Nubuck, Cera

Model 5721

Gomo Lounge Chair



Designed by Hugo Passos, 2023

Fully upholstered lounge chair. Inner construction consists of a wooden shell in moulded plywood and furniture board and seat is supported with webbing. Upholstered in HR or CMHR foam and cover in fabric or leather. Fabric cover is removable. Two base options available: A fixed base with plastic legs with reversible plastic glides which can be changed to felt. A metal swivel base with a black lacquered wooden plate mounted with plastic glides. Felt glides available.

Modeldetails

0,37 m³ Packaging dimensions:
27 kg / 25 kg L: 67 cm W: 72 cm H: 76 cm

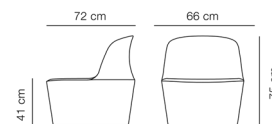

Essential Assortment

Item number	Upholstery	Frame	Price
5721193000005503271	Re-Wool 198	Fixed base, FSC Mix 70%	1.666
57211931100005503271	Re-Wool 128	Fixed base, FSC Mix 70%	1.666
57211930000005503305	Re-Wool 198	Swivel base, FSC Mix 70%	1.891
57211931100005503305	Re-Wool 128	Swivel base, FSC Mix 70%	1.891

Essential variants are delivered with plastic glides and HR foam

Order configuration

	Fixed base	Swivel base
Fabric group 0	1.556	1.776
Fabric group 1	1.673	1.910
Fabric group 2	1.783	2.016
Fabric group 3	1.888	2.118
Fabric group 4	2.068	2.294
Fabric group 5	2.423	2.640
C.O.M. fabric	1.673	1.910
Leather group 0	2.037	2.295
Leather group 1	2.219	2.477
Leather group 2	2.392	2.649
Leather group 3	2.603	2.848
Leather group 4	2.979	3.223
Leather group 5	3.630	3.874
C.O.M. leather	2.219	2.477
Sheepskin	3.067	3.307

Fabric consumption: 1,9 m. Leather consumption: 3,8 m²

When upholstered in velvet the stitching will not be visible.

Extra charge for

Return function base: +47

Certifications

FSC® certified

EU Ecolabel variants: Fixed or Swivel base together with HR foam and upholstery in Connect, Remix, Re-wool, Steelcut Quartet, Vidar, Tonus or Wave fabric
ANSI/BIFMA X5.4-2020

Recommended upholstery

Fabric group 0	Connect
Fabric group 1	Grand Linen, Capture, Re-wool, Bardal, Ruskin, Linara, Remix, Erik
Fabric group 2	Hallingdal, Foss, Sunniva, Barnum, Steelcut Trio, Fiord, Clay, Loop
Fabric group 3	Divina Melange, Vidar, Cotil, Elle
Fabric group 4	Safire, Sisu
Fabric group 5	Gentle
Leather group 0	Vice
Leather group 1	Omni
Leather group 2	Primo, Trace
Leather group 3	Max
Leather group 4	Vegeta, Nubuck, Organic

Model P5721

Gomo Accessories

Loose cover for Gomo Lounge Chair



Designed by Hugo Passos, 2023

Loose cover for re-upholstery of Gomo Chair. Please note there will not be visible stitching in velour textiles.
Professional assistance is recommended.

Order configuration

Fabric group 0	500
Fabric group 1	539
Fabric group 2	573
Fabric group 3	604
Fabric group 4	652
Fabric group 5	766
C.O.M. fabric	539

Fabric consumption: 1,9 m

Recommended upholstery

Fabric group 0	Connect
Fabric group 1	Grand Linen, Capture, Re-wool, Bardal, Ruskin, Linara, Remix, Erik
Fabric group 2	Hallingdal, Foss, Sunniva, Barnum, Steelcut Trio, Fiord, Clay, Loop
Fabric group 3	Divina Melange, Vidar, Elle, Cotil
Fabric group 4	Safire, Sisu
Fabric group 5	Gentle

Model 2229

The Hunting Chair Lounge chair



Designed by Børge Mogensen, 1950

Lounge chair of solid wood and saddle leather. Interchangeable seat and back made in vegetable tanned saddle leather with metal buckles. Leather seat has canvas backing. Saddle straps can be tightened as the leather expands through use.

Model details

0,45 m³ Packaging dimensions:
13 kg / L: 74 cm W: 88 cm H: 74 cm
10,5 kg

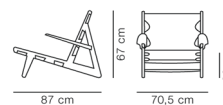

Essential Assortment

Item number	Upholstery	Wood	Price
222900650501	Leather, black	Oak black lacquered	4.333
222910750502	Leather, cognac	Oak light oil	4.583
222910350500	Leather, natural	Oak soap	4.999
222910950501	Leather, black	Smoked oak, oiled	5.416

Order configuration

	Oak soap	Oak oiled	Oak light oil	Oak black lacquered	Smoked oak, oiled
Natural leather	4.999	5.512	5.512	5.512	6.339
Black leather	4.974	4.974	4.974	4.333	5.416
Cognac leather	4.974	4.974	4.583	4.974	5.720

Certifications

EN 1022:2005, EN 16139:2013 (L1)

**Model
P2229**

The Hunting Chair Accessories Complete leather set for 2229

Designed by Børge Mogensen

Complete leather set made in vegetable tanned saddle leather with metal buckles. Leather seat has canvas backing. Saddle straps can be tightened as the leather expands through use.

Order configuration

Natural leather	Black leather	Cognac leather
3.155	2.571	2.571

Model 2204



Mogensen Wing Chair Easy Chair

Designed by Børge Mogensen, 1963

Fully upholstered easy chair with piping in all stitches. Available in leather or fabric. Fixed legs of solid wood, built into the wood internal frame. Seat is supported with jute and rubber band webbing. Separate seat cushion with removable covers. Please specify cushion type. Cushions are either with foam core with down wrap or filled with a foam and down mix in sepearate chambers.

Modeldetails

0,95 m³ Packaging dimensions:
65 kg / 29 kg L: 96 cm W: 77 cm H: 129 cm

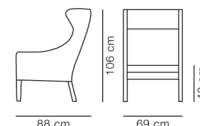

Essential Assortment

Item number	Upholstery	Wood	Price
22041645008810	Leather Primo 88, Black	Walnut oiled	7.499
22041035009010	Leather Vegeta 90, Natural	Oak soap	9.166
22041055090610	Leather Organic 906, Mocca	Oak oil	9.166
22041075084110	Leather Cera 905, Russet brown	Oak light oil	9.166

Essential variants only delivered with HR foam

Order configuration

	Oak soap	Oak oiled	Oak light oil	Oak black lacquered	Walnut oiled
Fabric group 1	5.906	5.906	5.906	5.906	5.906
Fabric group 2	6.261	6.261	6.261	6.261	6.261
Fabric group 3	6.618	6.618	6.618	6.618	6.618
Fabric group 4	7.279	7.279	7.279	7.279	7.279
Fabric group 5	8.043	8.043	8.043	8.043	8.043
Leather group 1	7.729	7.729	7.729	7.729	7.729
Leather group 2	8.067	8.067	8.067	8.067	8.067
Leather group 3	8.882	8.882	8.882	8.882	8.882
Leather group 4	9.770	9.770	9.770	9.770	9.770
Leather group 5	11.236	11.236	11.236	11.236	11.236
Selected fabrics	7.279	7.279	7.279	7.279	7.279

Fabric consumption: 5,8 m. Leather consumption: 11,61 m²

Recommended upholstery

Fabric group 1	Bardal, Ruskin, Linara, Capture, Remix, Re-wool, Grand Linen, Erik
Fabric group 2	Hallingdal, Sunniva, Fiord, Savoy, Clay, Barnum, Steelcut Trio, Foss, Loop
Fabric group 3	Divina Melange, Vidar
Fabric group 4	Sisu, Safire
Fabric group 5	Gentle
Leather group 1	Omni
Leather group 2	Primo
Leather group 3	Max
Leather group 4	Vegeta, Nubuck, Organic, Cera

Model 2207

Mogensen Club Chair Lounge Chair



Designed by Børge Mogensen, 1963

Fully upholstered lounge chair with piping in all stitches. Available in leather or fabric. Fixed legs of solid wood, built into the wood internal frame. Seat is supported with jute and rubber band webbing. Separate seat and back cushions with removable covers. Please specify cushion type. Cushions are either with foam core with down wrap or filled with a foam and down mix in separate chambers

Model details

0,53 m³ Packaging dimensions:
31 kg / 24 kg L: 86 cm W: 73 cm H: 86 cm

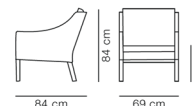

Essential Assortment

Item number	Upholstery	Wood	Price
22071645008810	Leather Primo 88, Black	Walnut oiled	5.833
22071035009010	Leather Vegeta 90, Natural	Oak soap	6.666
22071055090610	Leather Organic 906, Mocca	Oak oil	6.666
22071075084110	Leather Cera 905, Russet brown	Oak light oil	6.666

Essential variants only delivered with HR foam

Order configuration

	Oak soap	Oak oiled	Oak light oil	Oak black lacquered	Walnut oiled
Fabric group 1	4.817	4.817	4.817	4.817	4.817
Fabric group 2	5.097	5.097	5.097	5.097	5.097
Fabric group 3	5.377	5.377	5.377	5.377	5.377
Fabric group 4	5.898	5.898	5.898	5.898	5.898
Fabric group 5	6.500	6.500	6.500	6.500	6.500
Leather group 1	6.029	6.029	6.029	6.029	6.029
Leather group 2	6.304	6.304	6.304	6.304	6.304
Leather group 3	6.921	6.921	6.921	6.921	6.921
Leather group 4	7.613	7.613	7.613	7.613	7.613
Leather group 5	8.755	8.755	8.755	8.755	8.755
Selected fabrics	5.898	5.898	5.898	5.898	5.898

Fabric consumption: 5 m. Leather consumption: 8,71 m²

Recommended upholstery

Fabric group 1	Bardal, Ruskin, Linara, Capture, Remix, Re-wool, Grand Linen, Erik
Fabric group 2	Hallingdal, Sunniva, Fiord, Savoy, Clay, Barnum, Steelcut Trio, Foss, Loop
Fabric group 3	Divina Melange, Vidar
Fabric group 4	Sisu, Safire
Fabric group 5	Gentle
Leather group 1	Omni
Leather group 2	Primo, Trace
Leather group 3	Max
Leather group 4	Vegeta, Nubuck, Organic, Cera

Model 2202

Mogensen Ottoman



Designed by Børge Mogensen, 1963

Fully upholstered ottoman with piping in all stitches. Available in leather or fabric. Fixed legs of solid wood, built into the wood internal frame. Seat is supported with polyamide webbing. Separate seat cushion with removable cover. Please specify cushion type. Cushions are either with foam core with down wrap or filled with a foam and down mix in separate chambers

Modeldetails

0,2 m³ Packaging dimensions:
11 kg / 9 kg L: 60 cm W: 60 cm H: 55 cm

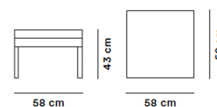

Essential Assortment

Item number	Upholstery	Wood	Price
22021645008810	Leather Primo 88, Black	Walnut oiled	2.083
22021035009010	Leather Vegeta 90, Natural	Oak soap	2.333
22021055090610	Leather Organic 906, Mocca	Oak oil	2.333
22021075084110	Leather Cera 905, Russet brown	Oak light oil	2.333

Essential variants only delivered with HR foam

Order configuration

	Oak soap	Oak oiled	Oak light oil	Oak black lacquered	Walnut oiled
Fabric group 1	1.960	1.960	1.960	1.960	1.960
Fabric group 2	2.097	2.097	2.097	2.097	2.097
Fabric group 3	2.234	2.234	2.234	2.234	2.234
Fabric group 4	2.488	2.488	2.488	2.488	2.488
Fabric group 5	2.781	2.781	2.781	2.781	2.781
Leather group 1	2.133	2.133	2.133	2.133	2.133
Leather group 2	2.204	2.204	2.204	2.204	2.204
Leather group 3	2.426	2.426	2.426	2.426	2.426
Leather group 4	2.669	2.669	2.669	2.669	2.669
Leather group 5	3.069	3.069	3.069	3.069	3.069

Fabric consumption: 2,5 m. Leather consumption: 3,13 m²

Recommended upholstery

Fabric group 1	Bardal, Ruskin, Linara, Capture, Remix, Re-wool, Grand Linen, Erik
Fabric group 2	Hallingdal, Sunniva, Fiord, Savoy, Clay, Barnum, Steelcut Trio, Foss, Loop
Fabric group 3	Divina Melange, Vidar
Fabric group 4	Sisu, Safire
Fabric group 5	Gentle
Leather group 1	Omni
Leather group 2	Primo, Trace
Leather group 3	Max
Leather group 4	Vegeta, Nubuck, Organic, Cera

Model 7421

Mono Pouf Ø39 cm



Designed by Due & Trapedach, 2020

Fully upholstered pouf with piping in all stitches. Inner frame of wood, seat undercarriage with webbing. Base in black lacquered MDF mounted with plastic glides. Upholstered with CMHR or HR foam. Available in fabric or leather. The cover is non-removable.

Modeldetails

0,1 m³ Packaging dimensions:
7,5 kg / 5,6 kg L: 44 cm W: 44 cm H: 50 cm

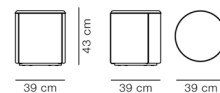

Order configuration

Fabric group 1	689
Fabric group 2	769
Fabric group 3	841
Fabric group 4	979
Fabric group 5	1.160
C.O.M. fabric	689
Leather group 1	1.044
Leather group 2	1.211
Leather group 3	1.385
Leather group 4	1.546
Leather group 5	1.777
C.O.M. leather	1.044

Fabric consumption: 1,3 m. Leather consumption: 2,4 m²

Certifications

EN 1022:2005, EN 16139:2013 (L2)

Recommended upholstery

Fabric group 0	Connect
Fabric group 1	Grand Linen, Remix, Capture, Bardal, Re-wool, Linara, Ruskin, Natural Linen, Erik
Fabric group 2	Hallingdal, Barnum, Loop, Steelcut Trio, Sunniva, Harald, Foss, Fiord, Clay, Savoy
Fabric group 3	Divina Melange, Vidar, Elle, Cotil
Fabric group 4	Grand Mohair, Sisu, Safire
Fabric group 5	Gentle
Leather group 0	Vice
Leather group 1	Omni
Leather group 2	Primo, Trace
Leather group 3	Max
Leather group 4	Nubuck, Organic, Vegeta, Cera

Model 7423

Mono Pouf Ø55 cm



Designed by Due & Trapedach, 2020

Fully upholstered pouf with piping in all stitches. Inner frame of wood, seat undercarriage with webbing. Base in black lacquered MDF mounted with plastic glides. Upholstered with CMHR or HR foam. Available in fabric or leather. The cover is non-removable.

Modeldetails

0,17 m³ Packaging dimensions:
11 kg / 8,2 kg L: 61 cm W: 61 cm H: 45 cm

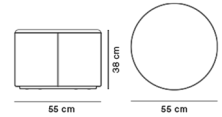

Order configuration

Fabric group 1	746
Fabric group 2	826
Fabric group 3	900
Fabric group 4	1.041
Fabric group 5	1.224
C.O.M. fabric	746
Leather group 1	1.106
Leather group 2	1.281
Leather group 3	1.459
Leather group 4	1.647
Leather group 5	1.894
C.O.M. leather	1.106

Fabric consumption: 1,4 m. Leather consumption: 3,2 m²

Certifications

EN 1022:2005, EN 16139:2013 (L2)

Recommended upholstery

Fabric group 0	Connect
Fabric group 1	Grand Linen, Remix, Capture, Bardal, Re-wool, Linara, Ruskin, Natural Linen, Erik
Fabric group 2	Hallingdal, Barnum, Loop, Steelcut Trio, Sunniva, Harald, Foss, Fiord, Clay, Savoy
Fabric group 3	Divina Melange, Vidar, Elle, Cotil
Fabric group 4	Grand Mohair, Sisu, Safire
Fabric group 5	Gentle
Leather group 0	Vice
Leather group 1	Omni
Leather group 2	Primo, Trace
Leather group 3	Max
Leather group 4	Nubuck, Organic, Vegeta, Cera

Model 7425

Mono Pouf Ø90 cm



Designed by Due & Trampedach, 2020

Fully upholstered pouf with piping in all stitches. Inner frame of wood, seat undercarriage with webbing. Base in black lacquered MDF mounted with plastic glides. Upholstered with CMHR or HR foam. Available in fabric or leather. The cover is non-removable.

Modeldetails

0,41 m³ Packaging dimensions:
22,5 kg / L: 96 cm W: 96 cm H: 45 cm
18 kg

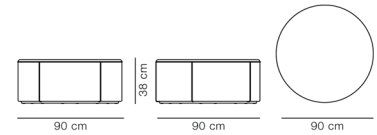

Order configuration

Fabric group 1	1.179
Fabric group 2	1.301
Fabric group 3	1.380
Fabric group 4	1.532
Fabric group 5	1.727
C.O.M. fabric	1.179
Leather group 1	1.647
Leather group 2	1.829
Leather group 3	2.020
Leather group 4	2.458
Leather group 5	2.827
C.O.M. leather	1.647

Fabric consumption: 2 m. Leather consumption: 5,2 m²

Certifications

EN 1022:2005, EN 16139:2013 (L2)

Recommended upholstery

Fabric group 0	Connect
Fabric group 1	Grand Linen, Remix, Capture, Bardal, Re-wool, Linara, Ruskin, Natural Linen, Erik
Fabric group 2	Hallingdal, Barnum, Loop, Steelcut Trio, Sunniva, Harald, Foss, Fiord, Clay, Savoy
Fabric group 3	Divina Melange, Vidar, Elle, Cotil
Fabric group 4	Grand Mohair, Sisu, Safire
Fabric group 5	Gentle
Leather group 0	Vice
Leather group 1	Omni
Leather group 2	Primo, Trace
Leather group 3	Max
Leather group 4	Nubuck, Organic, Vegeta, Cera

Model 4372

Pato Lounge Sledge base



Designed by Welling / Ludvik, 2016

Fully upholstered lounge chair. Frame of solid steel, chromed or powder coated. Inner shell of plywood with CMHR or HR foam, covered in fabric or leather. Cover is non-removable. Mounted with plastic glides.

Modeldetails

0,38 m³ Packaging dimensions:
15 kg / 9 kg L: 84 cm W: 73 cm H: 87 cm

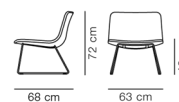

Order configuration

Frame: Chrome or black.

Fabric group 0	827
Fabric group 1	894
Fabric group 2	1.054
Fabric group 3	1.198
Fabric group 4	1.458
Fabric group 5	1.604
C.O.M. fabric	894
Leather group 0	943
Leather group 1	1.014
Leather group 2	1.252
Leather group 3	1.555
Leather group 4	1.710
Leather group 5	1.967
C.O.M. leather	1.014

Fabric consumption: 1,5 m. Leather consumption: 2,5 m²

Other frame colours by quotation.

Extra charge for

Glides with felt: +12

Certifications

FSC® certified

EN 1022:2005, EN 16139:2013 (L1)

Recommended upholstery

Fabric group 0	Connect
Fabric group 1	Grand Linen, Linara, Bardal, Capture, Remix, Re-wool, Ruskin, Natural Linen, Erik
Fabric group 2	Barnum, Hallingdal, Harald, Savoy, Clay, Sunniva, Steelcut Trio, Fiord, Foss, Loop
Fabric group 3	Vidar, Divina Melange, Elle, Cotil
Fabric group 4	Sisu, Grand Mohair, Safire
Fabric group 5	Gentle
Leather group 0	Vice
Leather group 1	Omni
Leather group 2	Primo, Trace
Leather group 3	Max
Leather group 4	Nubuck, Organic, Vegeta, Cera

Model 8805

Savannah Lounge Chair Petit



Designed by Monica Förster, 2022

Lounge chair with upholstered cushions. External frame of solid wood mounted with non-removable upholstery leather or 100% linen canvas. Cushions of cold cured foam upholstered in fabric. Cover is non-removable on frame and back. Cover on seat cushion is removable.

Modeldetails

0,45 m³ Packaging dimensions:
30 kg / 23 kg L: 76 cm W: 74 cm H: 77 cm

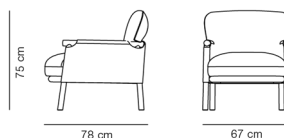

Order configuration

Frame: Oak light oil or oak black lacquered.

	Frame: Canvas	Frame: Leather gr. 1	Frame: Leather gr. 2	Frame: Leather gr. 3	Frame: Leather gr. 4	Frame: Leather gr. 5	Frame: Leather COM
Fabric group 1	3.207	3.284	3.351	3.448	3.545	3.642	3.284
Fabric group 2	3.318	3.396	3.463	3.560	3.657	3.754	3.396
Fabric group 3	3.429	3.507	3.574	3.671	3.768	3.865	3.507
Fabric group 4	3.613	3.691	3.758	3.855	3.952	4.049	3.691
Fabric group 5	3.875	3.953	4.019	4.116	4.213	4.310	3.953
C.O.M. fabric	3.207	3.284	3.351	3.448	3.545	3.642	3.284

Fabric consumption: 3,2 m

Certifications

EN 1022:2005, EN 16139:2013 (L2)

Recommended upholstery

Fabric group 1	Bardal, Re-wool, Ruskin, Capture, Grand Linen, Erik
Fabric group 2	Hallingdal, Sunniva, Fiord, Steelcut Trio, Clay, Barnum, Loop
Fabric group 3	Elle, Vidar, Divina Melange
Fabric group 4	Sisu, Safire
Fabric group 5	Gentle
Leather group 0	Vice
Leather group 1	Omni
Leather group 2	Primo, Trace
Leather group 3	Max
Leather group 4	Vegeta, Nubuck, Organic

Model 8801

Savannah Lounge Chair



Designed by Monica Förster, 2015

Lounge chair with upholstered cushions. External frame of solid wood mounted with non-removable upholstery leather or 100% linen canvas. Cushions of cold cured foam upholstered in fabric. Cover is non-removable on frame and back. Cover on seat cushion is removable.

Modeldetails

0,9 m³ Packaging dimensions:
34 kg / 29 kg L: 111 cm W: 98 cm H: 82 cm

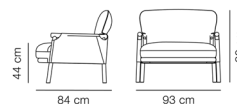

Order configuration

Frame: Oak light oil or oak black lacquered.

	Frame: Canvas	Frame: Leather gr. 1	Frame: Leather gr. 2	Frame: Leather gr. 3	Frame: Leather gr. 4	Frame: Leather gr. 5	Frame: Leather COM
Fabric group 1	3.951	4.031	4.100	4.200	4.300	4.400	4.031
Fabric group 2	4.172	4.252	4.321	4.421	4.521	4.621	4.252
Fabric group 3	4.279	4.359	4.427	4.527	4.627	4.727	4.359
Fabric group 4	4.598	4.678	4.746	4.846	4.946	5.046	4.678
Fabric group 5	5.517	5.597	5.666	5.766	5.866	5.966	5.597
C.O.M. fabric	3.951	4.031	4.100	4.200	4.300	4.400	4.031

Fabric consumption: 3,2 m

Saddle leather on the frame is available in leather group 5.

Note - arm cushions have to be ordered separately (P8801).

Certifications

EN 1022:2005, EN 16139:2013 (L2)

Recommended upholstery

Fabric group 1	Bardal, Re-wool, Ruskin, Capture, Grand Linen, Erik
Fabric group 2	Hallingdal, Sunniva, Fiord, Steelcut Trio, Clay, Barnum, Loop
Fabric group 3	Elle, Vidar, Divina Melange
Fabric group 4	Sisu, Safire
Fabric group 5	Gentle
Leather group 0	Vice
Leather group 1	Omni
Leather group 2	Primo, Trace
Leather group 3	Max
Leather group 4	Vegeta, Nubuck, Organic

Model 2226

The Spanish Chair Lounge chair



Designed by Børge Mogensen, 1958

Lounge chair of solid wood and saddle leather. Interchangeable seat and back made in vegetable tanned saddle leather with metal buckles. Leather seat has canvas backing. Saddle straps can be tightened as the leather expands through use.

Modeldetails

0,41 m³ Packaging dimensions:
16,5 kg / 12,1 kg L: 64 cm W: 87 cm H: 73 cm

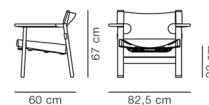

Essential Assortment

Item number	Upholstery	Wood	Price
222600650501	Leather, black	Oak black lacquered	3.749
222610750502	Leather, cognac	Oak light oil	3.749
222610350500	Leather, natural	Oak soap	4.166
222610950501	Leather, black	Smoked oak, oiled	4.333
222616450501	Leather, black	Walnut oiled	4.333

Order configuration

	Oak soap	Oak oiled	Oak light oil	Oak black lacquered	Smoked oak, oiled	Walnut oiled
Natural leather	4.166	4.523	4.523	4.523	5.286	5.286
Black leather	3.866	3.866	3.866	3.749	4.333	4.333
Cognac leather	3.866	3.866	3.749	3.866	4.606	4.606

Certifications

EN 1021-1:2006 - Smouldering cigarette, EN 1021-2:2006 - Match flame equivalent, EN 1022:2005, EN 16139:2013 (L2), EN ISO 6941:2003

**Model
P2226**

The Spanish Chair Accessories

Complete leather set for 2226

Designed by Børge Mogensen

Complete leather set with interchangeable seat and back made in vegetable tanned saddle leather with metal buckles. Leather seat has canvas backing. Saddle straps can be tightened as the leather expands through use.

Order configuration

Natural leather	Black leather	Cognac leather
2.518	1.822	1.822

Model 1710

Spine Lounge Chair



Designed by Space Copenhagen, 2016

Lounge chair with legs of solid wood. Wooden seat shell of moulded plywood. The cushion in CMHR or HR foam. Available in fabric or leather, with piping in all stitches. Cushions are kept in place with Velcro fixtures and are removable for cleaning.

Modeldetails

0,56 m³ Packaging dimensions:
45 kg / 34 kg L: 86 cm W: 86 cm H: 76 cm

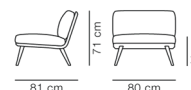

Essential Assortment

Item number	Upholstery	Wood	Price
171020200044807	Grand Linen Naturel 0024	Oak lacquer FSC Mix 70%	3.749
171022300050088	Leather Primo 88, Black	Black ash, FSC Mix 70%	4.166
171022300050841	Leather Cera 905, Russet brown	Black ash, FSC Mix 70%	4.583

Essential variants only delivered with HR foam

Order configuration

	Oak lacquered	Black ash	Smoked oak stained, lacquered
Fabric group 0	3.776	3.400	3.991
Fabric group 1	4.060	3.656	4.466
Fabric group 2	4.264	3.859	4.690
Fabric group 3	4.586	4.182	4.773
Fabric group 4	5.124	4.720	5.311
Fabric group 5	5.563	5.155	5.746
C.O.M. fabric	4.060	3.656	4.247
Leather group 0	3.969	3.593	4.184
Leather group 1	4.268	3.863	4.455
Leather group 2	4.669	4.265	4.856
Leather group 3	5.040	4.635	5.226
Leather group 4	5.544	5.099	5.690
Leather group 5	6.375	5.864	6.455
C.O.M. leather	4.268	3.863	4.455

Fabric consumption: 2,9 m. Leather consumption: 5 m²

QuickClick glides with felt upon request (R1730).

Certifications

FSC® certified
EN 1022:2005, EN 16139:2013 (L2)

Recommended upholstery

Fabric group 1	Grand Linen, Linara, Bardal, Capture, Remix, Re-wool, Ruskin, Natural Linen, Erik
Fabric group 2	Hallingdal, Harald, Savoy, Clay, Barnum, Sunniva, Steelcut Trio, Fiord, Foss, Loop
Fabric group 3	Vidar, Divina Melange, Cotil, Elle
Fabric group 4	Sisu, Grand Mohair, Safire
Fabric group 5	Gentle
Leather group 0	Vice
Leather group 1	Omni
Leather group 2	Primo, Trace
Leather group 3	Max
Leather group 4	Nubuck, Organic, Vegeta, Cera

Model 1711

Spine Lounge Chair Petit



Designed by Space Copenhagen, 2016

Lounge chair with legs of solid wood. Wooden seat shell of moulded plywood. Cushions in CMHR or HR foam. Available in fabric or leather, with piping in all stitches. Cushions are kept in place with Velcro fixtures and are removable for cleaning.

Modeldetails

0,38 m³ Packaging dimensions:
29 kg / 24 kg L: 75,5 cm W: 69,5 cm H: 72,5 cm

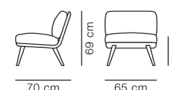

Essential Assortment

Item number	Upholstery	Wood	Price
171120244807000	Grand Linen Naturel 0024	Oak lacquer FSC Mix 70%	2.499
171122350088000	Leather Primo 88, Black	Black ash, FSC Mix 70%	2.666
171122350841000	Leather Cera 905, Russet brown	Black ash, FSC Mix 70%	3.333

Essential variants only delivered with HR foam

Order configuration

	Oak lacquered	Black ash	Smoked oak stained, lacquered
Fabric group 0	2.491	2.056	2.411
Fabric group 1	2.679	2.211	2.566
Fabric group 2	2.818	2.350	2.705
Fabric group 3	2.993	2.525	2.880
Fabric group 4	3.212	2.744	3.099
Fabric group 5	3.578	3.111	3.465
C.O.M. fabric	2.679	2.211	2.566
Leather group 0	2.605	2.186	2.540
Leather group 1	2.801	2.350	2.705
Leather group 2	3.107	2.657	3.012
Leather group 3	3.509	3.059	3.413
Leather group 4	3.860	3.364	3.719
Leather group 5	4.439	3.869	4.224
C.O.M. leather	2.801	2.350	2.705

Fabric consumption: 2,7 m. Leather consumption: 4,2 m²

Extra charge for

QuickClick glides with or without felt: +12

Certifications

FSC® certified
EN 1022:2005, EN 16139:2013 (L2)

Recommended upholstery

Fabric group 1	Grand Linen, Linara, Bardal, Capture, Remix, Re-wool, Ruskin, Natural Linen, Erik
Fabric group 2	Hallingdal, Harald, Savoy, Clay, Barnum, Sunniva, Steelcut Trio, Fiord, Foss, Loop
Fabric group 3	Vidar, Divina Melange, Cotil, Elle
Fabric group 4	Sisu, Grand Mohair, Safire
Fabric group 5	Gentle
Leather group 0	Vice
Leather group 1	Omni
Leather group 2	Primo, Trace
Leather group 3	Max
Leather group 4	Nubuck, Organic, Vegeta, Cera

Model 1770

Swoon Lounge Armchair Wood base



Designed by Space Copenhagen, 2016

Fully upholstered lounge chair with solid wood legs mounted with metal thread. Inner shell in moulded high pressure polyurethane foam, reinforced with a steel frame. Removable seat and back cushion of low emission foam, with removable cover. Available in fabric or leather.

Modeldetails

0,93 m³ Packaging dimensions:
32,8 kg / 18,6 kg L: 94 cm W: 94 cm H: 105 cm

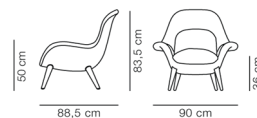

Essential Assortment

Item number	Upholstery	Legs	Price
17700772200005202000	Sunniva 242	Oak lacquer, FSC Mix 70%	2.549
17700773900005162000	Sunniva 717	Walnut lacquer	2.549
17700774500005224000	Sunniva 192	Oak black lacquer FSC Mix 70%	2.549
17700167500005202000	Elle 230	Oak lacquer, FSC Mix 70%	2.974
17701900900005162000	Grand Mohair 2103	Walnut lacquer	3.399

Essential variants only delivered with HR foam

Order configuration

Legs: Walnut lacquered, oak lacquered, oak oiled, smoked oak stained lacquered or oak black lacquered.

Fabric group 0	2.269
Fabric group 1	2.440
Fabric group 2	2.909
Fabric group 3	3.120
Fabric group 4	3.530
Fabric group 5	4.059
C.O.M. fabric	2.440
Leather group 1	3.249
Leather group 2	3.827
Leather group 3	4.329
Leather group 4	4.856
Leather group 5	5.585
C.O.M. leather	3.249

Fabric consumption: 4,4 m. Leather consumption: 8 m²

Different fabrics on corpus and cushion upon request.

Certifications

Oak is FSC® certified

Greenguard GOLD certified

EN 1022:2005, EN 16139:2013 (L2)

Recommended upholstery

Fabric group 0	Connect
Fabric group 1	Capture, Re-wool, Bardal, Ruskin, Linara, Remix, Erik
Fabric group 2	Hallingdal, Savoy, Foss, Sunniva, Barnum, Harald, Steelcut Trio, Fiord, Clay, Loop
Fabric group 3	Divina Melange, Vidar, Elle
Fabric group 4	Safire, Sisu, Grand Mohair
Fabric group 5	Gentle
Leather group 1	Omni
Leather group 2	Primo, Trace
Leather group 3	Max
Leather group 4	Vegeta, Nubuck, Organic

Model 1771

Swoon Ottoman Wood base

Designed by Space Copenhagen, 2018



Fully upholstered footstool with solid wood legs mounted with metal thread. Inner shell in moulded polyurethane foam, reinforced with a steel frame. Available in fabric or leather.

Modeldetails

0,15 m³ Packaging dimensions:
13 kg / 9,5 kg L: 55 cm W: 65 cm H: 48 cm



Essential Assortment

Item number	Upholstery	Legs	Price
17710772200005202000	Sunniva 242	Oak lacquer, FSC Mix 70%	899
17710773900005162000	Sunniva 717	Walnut lacquer	899
17710774500005224000	Sunniva 192	Oak black lacquer FSC Mix 70%	899
17710167500005202000	Elle 230	Oak lacquer, FSC Mix 70%	983
17711900900005162000	Grand Mohair 2103	Walnut lacquer	1.074

Essential variants only delivered with HR foam

Order configuration

Legs: Walnut lacquered, oak lacquered, oak oiled, smoked oak stained lacquered or oak black lacquered.

Fabric group 0	828
Fabric group 1	890
Fabric group 2	971
Fabric group 3	1.031
Fabric group 4	1.154
Fabric group 5	1.314
C.O.M. fabric	890
Leather group 1	1.368
Leather group 2	1.557
Leather group 3	1.748
Leather group 4	1.948
Leather group 5	2.241
C.O.M. leather	1.368

Fabric consumption: 2 m. Leather consumption: 2,5 m²

Certifications

Oak is FSC® certified

EN 1022:2005, EN 16139:2013 (L2)

Recommended upholstery

Fabric group 0	Connect
Fabric group 1	Capture, Re-wool, Bardal, Ruskin, Linara, Remix, Erik
Fabric group 2	Hallingdal, Savoy, Foss, Sunniva, Barnum, Harald, Steelcut Trio, Fiord, Clay, Loop
Fabric group 3	Divina Melange, Vidar, Elle
Fabric group 4	Safire, Sisu, Grand Mohair
Fabric group 5	Gentle
Leather group 1	Omni
Leather group 2	Primo, Trace
Leather group 3	Max
Leather group 4	Vegeta, Nubuck, Organic

Model 1774

Swoon Lounge Petit Armchair Wood base



Designed by Space Copenhagen, 2019

Fully upholstered lounge chair with solid wood legs mounted with metal thread. Inner shell in moulded high pressure polyurethane foam, reinforced with a steel frame. Removable seat and back cushion of low emission foam, with removable cover. Available in fabric or leather.

Modeldetails

0,61 m³ Packaging dimensions:
19 kg / L: 82,2 cm W: 83,7 cm H: 89 cm
13,5 kg

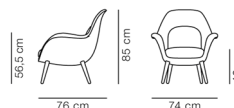

Essential Assortment

Item number	Upholstery	Legs	Price
17740772200005202000	Sunniva 242	Oak lacquer, FSC Mix 70%	2.124
17740773900005162000	Sunniva 717	Walnut lacquer	2.124
17740774500005224000	Sunniva 192	Oak black lacquer FSC Mix 70%	2.124
17740167500005202000	Elle 230	Oak lacquer, FSC Mix 70%	2.383
17741900900005162000	Grand Mohair 2103	Walnut lacquer	2.808

Essential variants only delivered with HR foam

Order configuration

Legs: Walnut lacquered, oak lacquered, oak oiled, smoked oak stained lacquered or oak black lacquered.

Fabric group 0	1.889
Fabric group 1	2.032
Fabric group 2	2.266
Fabric group 3	2.476
Fabric group 4	2.885
Fabric group 5	3.414
C.O.M. fabric	2.032
Leather group 1	2.290
Leather group 2	2.635
Leather group 3	2.935
Leather group 4	3.250
Leather group 5	3.737
C.O.M. leather	2.290

Fabric consumption: 3,9 m. Leather consumption: 6,5 m²

Different fabrics on corpus and cushion upon request.

Certifications

Oak is FSC® certified

Greenguard GOLD certified

EN 1022:2005, EN 16139:2013 (L2)

Recommended upholstery

Fabric group 0	Connect
Fabric group 1	Capture, Re-wool, Bardal, Ruskin, Linara, Remix, Erik
Fabric group 2	Hallingdal, Savoy, Foss, Sunniva, Barnum, Harald, Steelcut Trio, Fiord, Clay, Loop
Fabric group 3	Elle, Divina Melange, Vidar
Fabric group 4	Safire, Sisu, Grand Mohair
Fabric group 5	Gentle
Leather group 1	Omni
Leather group 2	Primo, Trace
Leather group 3	Max
Leather group 4	Vegeta, Nubuck, Organic

Model 1776

Swoon Lounge Petit Armchair Swivel base



Designed by Space Copenhagen, 2019

Fully upholstered lounge chair with aluminum swivel base. Inner shell in moulded high pressure polyurethane foam, reinforced with a steel frame. Removable seat and back cushion of low emission foam, with removable cover. Available in fabric or leather. Mounted with reversible plastic glides which can be changed to felt when reversed.

Modeldetails

0,61 m³ Packaging dimensions:
30 kg / 18 kg L: 82,2 cm W: 83,7 cm H: 89 cm



Essential Assortment

Item number	Upholstery	Frame	Price
17760772200005905072	Sunniva 242	Swivel base polished aluminium	2.291
17760773900005451071	Sunniva 717	Swivel base black	2.291
17760774500005451071	Sunniva 192	Swivel base black	2.291
17760167500005905072	Elle 230	Swivel base polished aluminium	2.549
17761900900005451071	Grand Mohair 2103	Swivel base black	2.974

Essential variants only delivered with HR foam

Order configuration

Frame: Polished aluminium or black.

Fabric group 0	2.110
Fabric group 1	2.269
Fabric group 2	2.503
Fabric group 3	2.713
Fabric group 4	3.123
Fabric group 5	3.651
C.O.M. fabric	2.269
Leather group 1	2.562
Leather group 2	2.907
Leather group 3	3.207
Leather group 4	3.522
Leather group 5	4.050
C.O.M. leather	2.562

Fabric consumption: 3,9 m. Leather consumption: 6,5 m²

Different fabrics on corpus and cushion upon request.

Certifications

Greenguard GOLD certified
EN 1022:2005, EN 16139:2013 (L2)

Recommended upholstery

Fabric group 0	Connect
Fabric group 1	Capture, Re-wool, Bardal, Ruskin, Linara, Remix, Erik
Fabric group 2	Hallingdal, Savoy, Foss, Sunniva, Barnum, Harald, Steelcut Trio, Fiord, Clay, Loop
Fabric group 3	Elle, Divina Melange, Vidar
Fabric group 4	Safire, Sisu, Grand Mohair
Fabric group 5	Gentle
Leather group 1	Omni
Leather group 2	Primo, Trace
Leather group 3	Max
Leather group 4	Vegeta, Nubuck, Organic

Model 1788

Wegner 1788 Lounge Chair



Designed by Hans J. Wegner, 1974

Easy chair with frame of solid wood. Seat supported by jute webbing. Interchangeable seat and back cushions of HR foam, covered in fabric or leather and finished with buttons. Back cushion attached with leather straps. Available in fabric or leather.

Modeldetails

0,45 m³ Packaging dimensions:
15 kg / 10 kg L: 70 cm W: 70 cm H: 92 cm

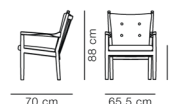

Essential Assortment

Item number	Upholstery	Wood	Price
17880055130130	Leather Omni 301, Black	Black lacquered	2.916
17882031410830	Capture 4201	Oak soap, FSC Mix 70%	2.916
17882031411230	Capture 5201	Oak soap, FSC Mix 70%	2.916
17882034480630	Natural Linen 0003	Oak soap, FSC Mix 70%	2.916
17882030095030	Cotil 863, 53938	Oak soap, FSC Mix 70%	3.083
17882035009530	Leather Max 95, Cognac	Oak soap, FSC Mix 70%	3.249

Essential variants only delivered with HR foam

Order configuration

	Oak soap	Oak oiled	Oak black lacquered
Fabric group 1	3.101	3.308	3.101
Fabric group 2	3.192	3.399	3.192
Fabric group 3	3.308	3.515	3.308
Fabric group 4	3.453	3.659	3.453
Fabric group 5	4.143	4.350	4.143
C.O.M. fabric	3.101	3.308	3.101
Leather group 1	3.115	3.322	3.115
Leather group 2	3.241	3.447	3.241
Leather group 3	3.405	3.611	3.405
Leather group 4	3.745	3.952	3.745
Leather group 5	4.307	4.514	4.307
C.O.M. leather	3.115	3.322	3.115

Fabric consumption: 1,3 m. Leather consumption: 4,2 m²

Extra charge for

QuickClick glides with or without felt (R1788): +12

Certifications

Oak is FSC® certified

Recommended upholstery

Fabric group 1	Grand Linen, Remix, Capture, Bardal, Re-wool, Linara, Ruskin, Natural Linen, Erik
Fabric group 2	Hallingdal, Barnum, Steelcut Trio, Sunniva, Foss, Fiord, Savoy, Clay
Fabric group 3	Cotil, Divina Melange, Vidar, Elle
Fabric group 4	Sisu, Safire
Fabric group 5	Gentle
Leather group 1	Omni
Leather group 2	Primo, Trace
Leather group 3	Max
Leather group 4	Organic, Nubuck, Vegeta, Cera

Model P1788

Wegner 1788 Accessories Cushions for 1788

Designed by Hans J. Wegner

Cushions for Wegner 1788 easy chair. Consists of seat and back cushions of HR foam, covered in fabric or leather and finished with buttons. Back cushion attached with leather straps. Available in fabric or leather.

Order configuration

Fabric group 1	885
Fabric group 2	969
Fabric group 3	1.077
Fabric group 4	1.211
Fabric group 5	1.453
C.O.M. fabric	885
Leather group 1	898
Leather group 2	1.014
Leather group 3	1.166
Leather group 4	1.283
Leather group 5	1.476
C.O.M. leather	898

Fabric consumption: 1,3 m. Leather consumption: 4,2 m²

Recommended upholstery

Fabric group 1	Grand Linen, Linara, Bardal, Capture, Remix, Natural Linen, Re-wool, Ruskin, Erik
Fabric group 2	Hallingdal, Clay, Barnum, Sunniva, Steelcut Trio, Fiord, Foss, Savoy
Fabric group 3	Vidar, Divina Melange, Cotil, Elle
Fabric group 4	Sisu, Safire
Fabric group 5	Gentle
Leather group 1	Omni
Leather group 2	Primo, Trace
Leather group 3	Max
Leather group 4	Nubuck, Vegeta, Organic, Cera

Model 16000



Wegner J16 Rocking Chair

Designed by Hans J. Wegner, 1944

Rocking chair in solid wood. Woven seat of paper cord.

Modeldetails

0,58 m³ Packaging dimensions:
13 kg / 11 kg L: 79 cm W: 64,5 cm H: 113 cm

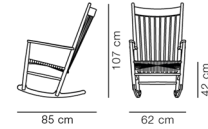

Essential Assortment

Item number	Seat	Wood	Price
1600020325000000	Natural paper cord	Oak soap, FSC Mix 70%	2.499
1600022425000000	Natural paper cord	Oak black lacquer, FSC Mix 70%	2.499
1600016425000000	Natural paper cord	Walnut oiled	2.916

Order configuration

	Oak black lacquered	Oak soap	Oak oiled	Oak light oil	Walnut oiled	Walnut lacquered
Seat natural paper cord	2.499	2.499	2.882	2.676	2.916	3.579
Seat black paper cord	2.719					

Certifications

Oak is FSC® certified

Model P1600H



Wegner J16 Accessories Cushions for J16

Designed by Hans J. Wegner

Cushions for Wegner J16 Rocking Chair. Loose seat, back or neck cushions in HR foam. Seat and back cushions with a back of granulated foam.

Essential Assortment

Item number	Type	Upholstery	Price
P1600H03448060	Seat cushion with cover	Natural Linen 0003	291
P1600H13513010	Neck cushion with	Leather Omni 301, Black	324
P1600H13513070	Neck cushion with	Leather Omni 307, Cognac	324
P1600H03513010	Seat cushion with cover	Leather Omni 301, Black	333
P1600H03513070	Seat cushion with cover	Leather Omni 307, Cognac	333
P1600H13448060	Neck cushion with	Natural Linen 0003	349
P1600H04513010	Back cushion with cover	Leather Omni 301, Black	415
P1600H04513070	Back cushion with cover	Leather Omni 307, Cognac	415
P1600H04448060	Back cushion with cover	Natural Linen 0003	416

Essential variants only delivered with HR foam

Order configuration

	Neck cushion	Back cushion	Seat cushion
Fabric group 1	361	426	305
Fabric group 2	418	541	362
Fabric group 3	491	686	434
Fabric group 4	582	868	525
Fabric group 5	698	1.042	630
C.O.M. fabric	361	426	305
Leather group 1	338	421	341
Leather group 2	407	573	447
Leather group 3	496	771	586
Leather group 4	546	849	645
Leather group 5	627	976	742
C.O.M. leather	338	421	341

Recommended upholstery

Fabric group 1	Grand Linen, Linara, Bardal, Capture, Remix, Natural Linen, Re-wool, Ruskin, Erik
Fabric group 2	Hallingdal, Barnum, Sunniva, Steelcut Trio, Fiord, Foss
Fabric group 3	Vidar, Divina Melange, Cotil
Fabric group 4	Sisu
Leather group 0	Vice
Leather group 1	Omni
Leather group 2	Primo, Trace
Leather group 3	Max
Leather group 4	Nubuck, Vegeta, Organic, Cera

Model 16002

Wegner J16 Stool



Designed by Hans J. Wegner, 1950

Footstool in solid wood. Woven seat of paper cord.

Modeldetails

0,1 m³

Packaging dimensions:

5 kg /
4 kg

L: 56 cm W: 40 cm H: 46 cm

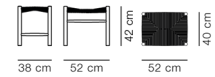

Essential Assortment

Item number	Seat	Wood	Price
1600220325000000	Natural paper cord	Oak soap, FSC Mix 70%	829
1600222425000000	Natural paper cord	Oak black lacquer, FSC Mix 70%	829
1600216425000000	Natural paper cord	Walnut oiled	913

Order configuration

	Oak black lacquered	Oak soap	Oak oiled	Oak light oil	Walnut oiled	Walnut lacquered
Seat natural paper cord	829	829	1.115	891	913	1.295
Seat black paper cord	970					

Extra charge for

QuickClick glides with or without felt (R16002): +12

Certifications

Oak is FSC® certified

Model P16002

Wegner J16 Accessories Cushion for J16 Stool

Designed by Hans J. Wegner

Cushions for Wegner J16 Rocking Chair. Loose cushions in foam.

Order configuration

	Cushion
Fabric group 1	269
Fabric group 2	290
Fabric group 3	315
Fabric group 4	340
Fabric group 5	409
C.O.M. fabric	269
Leather group 1	284
Leather group 2	350
Leather group 3	421
Leather group 4	463
Leather group 5	533
C.O.M. leather	284

Fabric consumption: 0,6 m. Leather consumption: 0,84 m²

Recommended upholstery

Fabric group 1	Grand Linen, Linara, Bardal, Capture, Remix, Natural Linen, Re-wool, Ruskin, Erik
Fabric group 2	Hallingdal, Barnum, Sunniva, Steelcut Trio, Fiord, Foss
Fabric group 3	Vidar, Divina Melange, Cotil
Fabric group 4	Sisu
Leather group 1	Omni
Leather group 2	Primo, Trace
Leather group 3	Max
Leather group 4	Nubuck, Vegeta, Organic, Cera

Model 1000

Wegner Ox Chair Easy chair



Designed by Hans J. Wegner, 1960

Fully upholstered easy chair in fabric or leather. Inner frame of solid wood and moulded cold cured foam. Pads at neck and armrest includes piping, available in leather as contrast to fabric upholstery. Stainless steel base. Mounted with plastic glides.

Modeldetails

1,1 m³ Packaging dimensions:
73 kg / 31 kg L: 103 cm W: 97 cm H: 117 cm

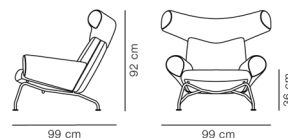

Essential Assortment

Item number	Upholstery	Piping	Frame	Price
1000002680900260100	Hallingdal 116	Leather Max 95, Cognac	Brushed stainless steel	8.641
1000500880909060100	Leather Primo 88, Black	Piping as upholstery	Brushed stainless steel	10.499
1000508410909060100	Leather Cera 905, Russet brown	Piping as upholstery	Brushed stainless steel	11.271

Essential variants only delivered with HR foam

Order configuration

	Black	Brushed stainless steel
Fabric group 1	8.716	8.716
Fabric group 2	9.022	9.022
Fabric group 3	9.169	9.169
Fabric group 4	9.610	9.610
Fabric group 5	11.517	11.517
C.O.M. fabric	8.716	8.716
Leather group 2	11.002	11.002
Leather group 3	11.837	11.837
Leather group 4	12.252	12.252
Leather group 5	14.078	14.078
C.O.M. leather	10.464	10.464

Fabric consumption: 4,5 m. Leather consumption: 13 m²

Not available in Trace leather.

Leather piping for furniture with fabric: +103
Arm pads in leather for furniture with fabric: +77

Certifications

EN 1022:2005, EN 16139:2013 (L2)

Recommended upholstery

Fabric group 1	Linara, Bardal, Capture, Re-wool, Ruskin, Erik
Fabric group 2	Hallingdal, Clay, Barnum, Sunniva, Steelcut Trio, Fiord, Foss
Fabric group 3	Vidar, Divina Melange
Leather group 2	Primo
Leather group 3	Max
Leather group 4	Nubuck, Vegeta, Organic, Cera

Model 1002

Wegner Ox Ottoman



Designed by Hans J. Wegner, 1960

Fully upholstered footstool in fabric or leather for Ox Chair and Queen Chair. Inner frame of solid wood and moulded cold cured foam. Side pads available in leather as contrast to fabric upholstery. Stainless steel base. Mounted with plastic glides.

Modeldetails

0,17 m³ Packaging dimensions:
13 kg / 11 kg L: 80 cm W: 56 cm H: 38 cm



Essential Assortment

Item number	Upholstery	Frame	Price
1002002680909060100	Hallingdal 116	Brushed stainless steel	2.191
1002500880909060100	Leather Primo 88, Black	Brushed stainless steel	2.449
1002508410909060100	Leather Cera 905, Russet brown	Brushed stainless steel	2.624

Essential variants only delivered with HR foam

Order configuration

	Black	Brushed stainless steel
Fabric group 1	2.148	2.148
Fabric group 2	2.211	2.211
Fabric group 3	2.241	2.241
Fabric group 4	2.332	2.332
Fabric group 5	2.798	2.798
C.O.M. fabric	2.148	2.148
Leather group 2	2.618	2.618
Leather group 3	2.790	2.790
Leather group 4	2.875	2.875
Leather group 5	3.306	3.306
C.O.M. leather	2.507	2.507

Fabric consumption: 0,9 m. Leather consumption: 4,5 m²

Not available in Trace leather.

Extra charge for

Side pads in leather for furniture with fabric: +77

Recommended upholstery

Fabric group 1	Linara, Bardal, Capture, Re-wool, Ruskin, Erik
Fabric group 2	Hallingdal, Clay, Barnum, Sunniva, Steelcut Trio, Fiord, Foss
Fabric group 3	Vidar, Divina Melange
Leather group 2	Primo
Leather group 3	Max
Leather group 4	Nubuck, Vegeta, Organic, Cera

Model 1010

Wegner Queen Chair Easy chair



Designed by Hans J. Wegner, 1960

Fully upholstered easy chair in fabric or leather. Inner frame of solid wood and moulded cold cured foam. Piping at backrest and arm pads available in leather as contrast to fabric upholstery. Stainless steel base. Mounted with plastic glides.

Modeldetails

1,1 m³ Packaging dimensions:
71 kg / 28 kg L: 103 cm W: 97 cm H: 117 cm

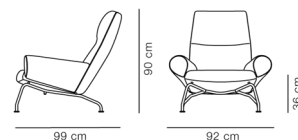

Essential Assortment

Item number	Upholstery	Piping	Frame	Price
1010002680900260100	Hallingdal 116	Leather Max 95, Cognac	Brushed stainless steel	6.566
1010500880909060100	Leather Primo 88, Black	Piping as upholstery	Brushed stainless steel	7.874
1010508410909060100	Leather Cera 905, Russet brown	Piping as upholstery	Brushed stainless steel	8.646

Essential variants only delivered with HR foam

Order configuration

	Black	Brushed stainless steel
Fabric group 1	6.572	6.572
Fabric group 2	6.828	6.828
Fabric group 3	6.952	6.952
Fabric group 4	7.323	7.323
Fabric group 5	8.787	8.787
C.O.M. fabric	6.572	6.572
Leather group 2	8.492	8.492
Leather group 3	9.194	9.194
Leather group 4	9.542	9.542
Leather group 5	10.973	10.973
C.O.M. leather	8.040	8.040

Fabric consumption: 3,8 m. Leather consumption: 9,5 m²

Not available in Trace leather.

Extra charge for

Leather piping for furniture with fabric:	+103
Arm pads in leather for furniture with fabric:	+53

Recommended upholstery

Fabric group 1	Linara, Bardal, Capture, Re-wool, Ruskin, Erik
Fabric group 2	Hallingdal, Clay, Barnum, Sunniva, Steelcut Trio, Fiord, Foss
Fabric group 3	Vidar, Divina Melange
Leather group 2	Primo
Leather group 3	Max
Leather group 4	Nubuck, Vegeta, Organic, Cera

Model P1010

Wegner Queen Accessories Neck cushion

Designed by Hans J. Wegner, 1960

Removable neck cushion for Wegner Queen Chair. Available in leather only.

Order configuration

Leather group 2	406
Leather group 3	459
Leather group 4	486
Leather group 5	559
C.O.M. leather	371

Leather consumption: 0,5 m²

Recommended upholstery

Leather group 2	Primo
Leather group 3	Max
Leather group 4	Nubuck, Vegeta, Organic, Cera

Sofas & Daybeds

Model 5622

Calmo Sofa 2 seater, 80 cm cushions



Designed by Hugo Passos, 2019

Sofa with separate seat and back cushions. Inner frame of wood with nozag springs. Available in fabric or leather. Cushions available in foam core with down wrap or solid foam (CMHR or HR). External cover is non-removable. Cushion covers are removable. Leg trestles in solid wood or steel. Mounted with plastic glides. Felt glides available.

Modeldetails

1,06 m³ Packaging dimensions:
71 kg / 58 kg L: 174 cm W: 94 cm H: 65 cm

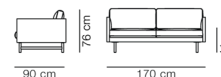

Essential Assortment

Item number	Upholstery	Frame	Price
5622028019311040046	Re-Wool 128	Black	3.749
5622028019311085446	Re-Wool 128	Oak lacquer, FSC Mix 70%	3.749
5622028007739040046	Sunniva 717	Black	4.166
5622028007739085446	Sunniva 717	Oak lacquer, FSC Mix 70%	4.166

Essential variants are delivered with plastic glides and HR foam core with down wrap

Order configuration

	Oak lacquered	Smoked oak stained, lacquered	Metal black	Matt chrome
Fabric group 1	4.023	4.023	4.023	4.023
Fabric group 2	4.310	4.310	4.310	4.310
Fabric group 3	4.865	4.865	4.865	4.865
Fabric group 4	5.700	5.700	5.700	5.700
Fabric group 5	6.777	6.777	6.777	6.777
C.O.M. fabric	4.023	4.023	4.023	4.023
Leather group 1	5.152	5.152	5.152	5.152
Leather group 2	6.486	6.486	6.486	6.486
Leather group 3	7.726	7.726	7.726	7.726
Leather group 4	8.498	8.498	8.498	8.498
Leather group 5	9.773	9.773	9.773	9.773
C.O.M. leather	5.152	5.152	5.152	5.152

Fabric consumption: 7,43 m. Leather consumption: 16,5 m²

Note - Complementary cushions are ordered separately (P5522).

Certifications

FSC® certified

EN 1022:2005, EN 16139:2013 (L2)

Recommended upholstery

Fabric group 1	Grand Linen, Remix, Capture, Bardal, Re-wool, Linara, Ruskin, Natural Linen, Erik
Fabric group 2	Hallingdal, Barnum, Loop, Steelcut Trio, Sunniva, Harald, Foss, Fiord, Clay, Savoy
Fabric group 3	Cotil, Divina Melange, Elle, Vidar
Fabric group 4	Sisu, Safire
Fabric group 5	Gentle
Leather group 1	Omni
Leather group 2	Primo, Trace
Leather group 3	Max
Leather group 4	Nubuck, Organic, Vegeta, Cera

Model 5652

Calmo Sofa 2 seater, 95 cm cushions



Designed by Hugo Passos, 2019

Sofa with separate seat and back cushions. Inner frame of wood with nozag springs. Available in fabric or leather. Cushions available in foam core with down wrap or solid foam (CMHR or HR). External cover is non-removable. Cushion covers are removable. Leg trestles in solid wood or steel. Mounted with plastic glides. Felt glides available.

Modeldetails

1,2 m³ Packaging dimensions:
83 kg / 64 kg L: 202 cm W: 93 cm H: 64 cm

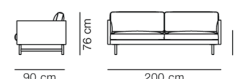

Essential Assortment

Item number	Upholstery	Frame	Price
5652029519311040046	Re-Wool 128	Black	3.583
5652029519311085446	Re-Wool 128	Oak lacquer, FSC Mix 70%	3.583
5652029507722040046	Sunniva 242	Black	4.166
5652029507722085446	Sunniva 242	Oak lacquer, FSC Mix 70%	4.166
5652029507739040046	Sunniva 717	Black	4.166
5652029507739085446	Sunniva 717	Oak lacquer, FSC Mix 70%	4.166
5652029507878040046	Sunniva 783	Black	4.166
5652029507878085446	Sunniva 783	Oak lacquer, FSC Mix 70%	4.166

Essential variants are delivered with plastic glides and HR foam core with down wrap

Order configuration

	Oak lacquered	Smoked oak stained, lacquered	Metal black	Matt chrome
Fabric group 1	4.228	4.228	4.228	4.228
Fabric group 2	4.722	4.722	4.722	4.722
Fabric group 3	5.301	5.301	5.301	5.301
Fabric group 4	6.283	6.283	6.283	6.283
Fabric group 5	7.551	7.551	7.551	7.551
C.O.M. fabric	4.228	4.228	4.228	4.228
Leather group 1	5.638	5.638	5.638	5.638
Leather group 2	7.209	7.209	7.209	7.209
Leather group 3	8.668	8.668	8.668	8.668
Leather group 4	9.535	9.535	9.535	9.535
Leather group 5	10.965	10.965	10.965	10.965
C.O.M. leather	5.638	5.638	5.638	5.638

Fabric consumption: 8,32 m. Leather consumption: 20 m²

Note - Complementary cushions are ordered separately (P5522).

Certifications

FSC® certified

EN 1022:2005, EN 16139:2013 (L2)



Recommended upholstery

Fabric group 1	Grand Linen, Remix, Capture, Bardal, Re-wool, Linara, Ruskin, Natural Linen, Erik
Fabric group 2	Hallingdal, Barnum, Loop, Steelcut Trio, Sunniva, Harald, Foss, Fiord, Clay, Savoy
Fabric group 3	Cotil, Divina Melange, Elle, Vidar
Fabric group 4	Sisu, Safire
Fabric group 5	Gentle
Leather group 1	Omni
Leather group 2	Primo, Trace
Leather group 3	Max
Leather group 4	Nubuck, Organic, Vegeta, Cera

Model 5623

Calmo Sofa 3 seater, 80 cm cushions

Modeldetails

 1,5 m³ Packaging dimensions:
 98 kg / 77 kg L: 252 cm W: 93 cm H: 64 cm



Designed by Hugo Passos, 2019

Sofa with separate seat and back cushions. Inner frame of wood with nozag springs. Available in fabric or leather. Cushions available in foam core with down wrap or solid foam (CMHR or HR). External cover is non-removable. Cushion covers are removable. Leg trestles in solid wood or steel. Mounted with plastic glides. Felt glides available.

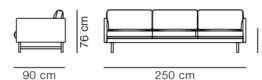

Essential Assortment

Item number	Upholstery	Frame	Price
5623038019311040046	Re-Wool 128	Black	4.583
5623038019311085446	Re-Wool 128	Oak lacquer, FSC Mix 70%	4.583
5623038007722040046	Sunniva 242	Black	4.999
5623038007722085446	Sunniva 242	Oak lacquer, FSC Mix 70%	4.999
5623038007739040046	Sunniva 717	Black	4.999
5623038007739085446	Sunniva 717	Oak lacquer, FSC Mix 70%	4.999
5623038007878040046	Sunniva 783	Black	4.999
5623038007878085446	Sunniva 783	Oak lacquer, FSC Mix 70%	4.999

Essential variants are delivered with plastic glides and HR foam core with down wrap

Order configuration

	Oak lacquered	Smoked oak stained, lacquered	Metal black	Matt chrome
Fabric group 1	5.074	5.074	5.074	5.074
Fabric group 2	5.356	5.356	5.356	5.356
Fabric group 3	6.068	6.068	6.068	6.068
Fabric group 4	7.132	7.132	7.132	7.132
Fabric group 5	8.506	8.506	8.506	8.506
C.O.M. fabric	5.074	5.074	5.074	5.074
Leather group 1	6.433	6.433	6.433	6.433
Leather group 2	8.136	8.136	8.136	8.136
Leather group 3	9.717	9.717	9.717	9.717
Leather group 4	10.689	10.689	10.689	10.689
Leather group 5	12.292	12.292	12.292	12.292
C.O.M. leather	6.433	6.433	6.433	6.433

Fabric consumption: 10,2 m. Leather consumption: 29,5 m²

Note - Complementary cushions are ordered separately (P5522).

Certifications

FSC® certified

EN 1022:2005, EN 16139:2013 (L2)

Recommended upholstery

Fabric group 1	Grand Linen, Remix, Capture, Bardal, Re-wool, Linara, Ruskin, Natural Linen, Erik
Fabric group 2	Hallingdal, Barnum, Loop, Steelcut Trio, Sunniva, Harald, Foss, Fiord, Clay, Savoy
Fabric group 3	Cotil, Divina Melange, Elle, Vidar
Fabric group 4	Sisu, Safire
Fabric group 5	Gentle
Leather group 1	Omni
Leather group 2	Primo, Trace
Leather group 3	Max
Leather group 4	Nubuck, Organic, Vegeta, Cera

Model 5625

Calmo Chaise Sofa 80 cm cushions, Chaise L or R

Modeldetails

2,1 m³ Packaging dimensions:
118 kg / 93 kg L: 252/96 cm W: 93/68 cm H: 64/45 cm



Designed by Hugo Passos, 2019

Sofa with separate seat and back cushions. Inner frame of wood with nozag springs. Available in fabric or leather. Cushions available in foam core with down wrap or solid foam (CMHR or HR). External cover is non-removable. Cushion covers are removable. Leg trestles in solid wood or steel. The placement of the chaise lounge can be changed on the spot using a standard hex key. Mounted with plastic glides. Felt glides available.

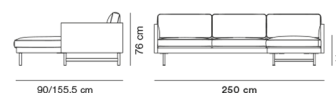

Order configuration

	Oak lacquered	Smoked oak stained, lacquered	Metal black	Matt chrome
Fabric group 1	6.035	6.035	6.035	6.035
Fabric group 2	6.610	6.610	6.610	6.610
Fabric group 3	7.329	7.329	7.329	7.329
Fabric group 4	8.628	8.628	8.628	8.628
Fabric group 5	10.306	10.306	10.306	10.306
C.O.M. fabric	6.035	6.035	6.035	6.035
Leather group 1	7.774	7.774	7.774	7.774
Leather group 2	9.854	9.854	9.854	9.854
Leather group 3	11.784	11.784	11.784	11.784
Leather group 4	12.963	12.963	12.963	12.963
Leather group 5	14.907	14.907	14.907	14.907
C.O.M. leather	7.774	7.774	7.774	7.774

Fabric consumption: 11,3 m. Leather consumption: 40,5 m²

Note - Complementary cushions are ordered separately (P5522).

Certifications

FSC® certified

EN 1022:2005, EN 16139:2013 (L2)

Recommended upholstery

Fabric group 1	Grand Linen, Remix, Capture, Bardal, Re-wool, Linara, Ruskin, Natural Linen, Erik
Fabric group 2	Hallingdal, Barnum, Loop, Steelcut Trio, Sunniva, Harald, Foss, Fiord, Clay, Savoy
Fabric group 3	Cotil, Divina Melange, Elle, Vidar
Fabric group 4	Sisu, Safire
Fabric group 5	Gentle
Leather group 1	Omni
Leather group 2	Primo, Trace
Leather group 3	Max
Leather group 4	Nubuck, Organic, Vegeta, Cera

Model 5620

Calmo Ottoman 80 cm cushion



Designed by Hugo Passos, 2019

Ottoman with separate seat cushion. Inner frame of wood with nozag springs. Available in fabric or leather. Cushions available in foam core with down wrap or solid foam (CMHR or HR). External cover is non-removable. Cushion cover are removable. Leg trestles in solid wood or steel. Mounted with plastic glides. Felt glides available.

Model details

0,29 m³ Packaging dimensions:
23 kg / 15,5 kg L: 68 cm W: 96 cm H: 45 cm



Order configuration

	Oak lacquered	Smoked oak stained, lacquered	Metal black	Matt chrome
Fabric group 1	1.867	1.867	1.867	1.867
Fabric group 2	2.011	2.011	2.011	2.011
Fabric group 3	2.132	2.132	2.132	2.132
Fabric group 4	2.362	2.362	2.362	2.362
Fabric group 5	2.659	2.659	2.659	2.659
C.O.M. fabric	1.867	1.867	1.867	1.867
Leather group 1	2.211	2.211	2.211	2.211
Leather group 2	2.579	2.579	2.579	2.579
Leather group 3	2.921	2.921	2.921	2.921
Leather group 4	3.213	3.213	3.213	3.213
Leather group 5	3.695	3.695	3.695	3.695
C.O.M. leather	2.211	2.211	2.211	2.211

Fabric consumption: 1,74 m. Leather consumption: 4 m²

Certifications

EN 1022:2005, EN 16139:2013 (L2)

Recommended upholstery

Fabric group 1	Grand Linen, Remix, Capture, Bardal, Re-wool, Linara, Ruskin, Natural Linen, Erik
Fabric group 2	Hallingdal, Barnum, Loop, Steelcut Trio, Sunniva, Harald, Foss, Fiord, Clay, Savoy
Fabric group 3	Cotil, Divina Melange, Elle, Vidar
Fabric group 4	Sisu, Safire
Fabric group 5	Gentle
Leather group 1	Omni
Leather group 2	Primo, Trace
Leather group 3	Max
Leather group 4	Nubuck, Organic, Vegeta, Cera

Model P5522

Calmo Accessories Set of 3 pillow cushions



Designed by Hugo Passos

Decorative cushion for Calmo. Down filling. Removable cover in fabric. Available in fabric or leather.

Modeldetails

Packaging dimensions:

3,5 kg /
3 kg

L: 41 cm W: 41 cm H: 10 cm

Essential Assortment

Item number	Upholstery	Price
P552219311019	Re-Wool 128	266
P552207722019	Sunniva 242	333
P552207739019	Sunniva 717	333
P552207878019	Sunniva 783	333

Order configuration

Fabric group 1	292
Fabric group 2	366
Fabric group 3	429
Fabric group 4	540
Fabric group 5	682
C.O.M. fabric	292
Leather group 1	467
Leather group 2	643
Leather group 3	807
Leather group 4	888
Leather group 5	1.021
C.O.M. leather	467

Fabric consumption: 1,36 m. Leather consumption: 1,5 m²

Cushion: 40 x 40 cm.

Recommended upholstery

Fabric group 1	Grand Linen, Linara, Bardal, Capture, Remix, Natural Linen, Re-wool, Ruskin, Erik
Fabric group 2	Hallingdal, Harald, Savoy, Clay, Barnum, Sunniva, Steelcut Trio, Fiord, Foss, Loop
Fabric group 3	Vidar, Divina Melange, Elle, Cotil
Fabric group 4	Sisu, Safire
Fabric group 5	Gentle

Model 562A

Calmo Elements Configuration A, 333 x 253cm

Modeldetails

- 3,1 m³
- 200 kg /
163 kg



Designed by Hugo Passos, 2022

Sofa with separate seat and back cushions. Inner frame of wood with nozag springs. Available in fabric. Cushions available in foam core with down wrap or solid foam (CMHR or HR). External cover is non-removable. Cushion covers are removable. Leg trestles in solid wood or steel. Mounted with plastic glides. Felt glides available.



Order configuration

Leg trestles: Oak lacquered, Smoked oak stained lacquered, Metal black or Matt chrome

Fabric group 1	10.563
Fabric group 2	11.337
Fabric group 3	12.809
Fabric group 4	15.088
Fabric group 5	17.978
C.O.M. fabric	10.563

Fabric consumption: 19,22 m

Note - Complementary cushions are ordered separately (P5522).

Certifications

FSC® certified

EN 1022:2005, EN 16139:2013 (L2)

Recommended upholstery

Fabric group 1	Grand Linen, Linara, Bardal, Capture, Remix, Natural Linen, Re-wool, Ruskin, Erik
Fabric group 2	Hallingdal, Harald, Savoy, Clay, Barnum, Sunniva, Steelcut Trio, Fiord, Foss, Loop
Fabric group 3	Vidar, Divina Melange, Elle, Cotil
Fabric group 4	Sisu, Safire
Fabric group 5	Gentle

Model 562B

Calmo Elements Configuration B, 333 x 253cm

Modeldetails

- 3,1 m³
- 200 kg /
163 kg



Designed by Hugo Passos, 2022

Sofa with separate seat and back cushions. Inner frame of wood with nozag springs. Available in fabric. Cushions available in foam core with down wrap or solid foam (CMHR or HR). External cover is non-removable. Cushion covers are removable. Leg trestles in solid wood or steel. Mounted with plastic glides. Felt glides available.



Order configuration

Leg trestles: Oak lacquered, Smoked oak stained lacquered, Metal black or Matt chrome

Fabric group 1	10.563
Fabric group 2	11.337
Fabric group 3	12.809
Fabric group 4	15.088
Fabric group 5	17.978
C.O.M. fabric	10.563

Fabric consumption: 19,22 m

Note - Complementary cushions are ordered separately (P5522).

Certifications

FSC® certified

EN 1022:2005, EN 16139:2013 (L2)

Recommended upholstery

Fabric group 1	Grand Linen, Linara, Bardal, Capture, Remix, Natural Linen, Re-wool, Ruskin, Erik
Fabric group 2	Hallingdal, Harald, Savoy, Clay, Barnum, Sunniva, Steelcut Trio, Fiord, Foss, Loop
Fabric group 3	Vidar, Divina Melange, Elle, Cotil
Fabric group 4	Sisu, Safire
Fabric group 5	Gentle

Model 562C

Calmo Elements Configuration C, 333 x 333cm

Modeldetails

3,54 m³
227 kg /
182 kg



Designed by Hugo Passos, 2022

Sofa with separate seat and back cushions. Inner frame of wood with nozag springs. Available in fabric. Cushions available in foam core with down wrap or solid foam (CMHR or HR). External cover is non-removable. Cushion covers are removable. Leg trestles in solid wood or steel. Mounted with plastic glides. Felt glides available.



Order configuration

Leg trestles: Oak lacquered, Smoked oak stained lacquered, Metal black or Matt chrome

Fabric group 1	11.614
Fabric group 2	12.383
Fabric group 3	14.012
Fabric group 4	16.520
Fabric group 5	19.707
C.O.M. fabric	11.614

Fabric consumption: 21,9 m

Note - Complementary cushions are ordered separately (P5522).

Certifications

FSC® certified

EN 1022:2005, EN 16139:2013 (L2)

Recommended upholstery

Fabric group 1	Grand Linen, Linara, Bardal, Capture, Remix, Natural Linen, Re-wool, Ruskin, Erik
Fabric group 2	Hallingdal, Harald, Savoy, Clay, Barnum, Sunniva, Steelcut Trio, Fiord, Foss, Loop
Fabric group 3	Vidar, Divina Melange, Elle, Cotil
Fabric group 4	Sisu, Safire
Fabric group 5	Gentle

Model 562D

Calmo Elements Configuration D, 253 x 253cm

Modeldetails

2,66 m³
173 kg /
144 kg



Designed by Hugo Passos, 2022

Sofa with separate seat and back cushions. Inner frame of wood with nozag springs. Available in fabric. Cushions available in foam core with down wrap or solid foam (CMHR or HR). External cover is non-removable. Cushion covers are removable. Leg trestles in solid wood or steel. Mounted with plastic glides. Felt glides available.



Order configuration

Leg trestles: Oak lacquered, Smoked oak stained lacquered, Metal black or Matt chrome

Fabric group 1	9.512
Fabric group 2	10.291
Fabric group 3	11.606
Fabric group 4	13.656
Fabric group 5	16.249
C.O.M. fabric	9.512

Fabric consumption: 16,54 m

Note - Complementary cushions are ordered separately (P5522).

Certifications

FSC® certified

EN 1022:2005, EN 16139:2013 (L2)

Recommended upholstery

Fabric group 1	Grand Linen, Linara, Bardal, Capture, Remix, Natural Linen, Re-wool, Ruskin, Erik
Fabric group 2	Hallingdal, Harald, Savoy, Clay, Barnum, Sunniva, Steelcut Trio, Fiord, Foss, Loop
Fabric group 3	Vidar, Divina Melange, Elle, Cotil
Fabric group 4	Sisu, Safire
Fabric group 5	Gentle

Model 562E

Calmo Elements Configuration E, 253 x 174cm

Modeldetails

2,14 m³
149 kg /
130 kg



Designed by Hugo Passos, 2022

Sofa with separate seat and back cushions. Inner frame of wood with nozag springs. Available in fabric. Cushions available in foam core with down wrap or solid foam (CMHR or HR). External cover is non-removable. Cushion covers are removable. Leg trestles in solid wood or steel. Mounted with plastic glides. Felt glides available.

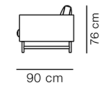

Order configuration

Leg trestles: Oak lacquered, Smoked oak stained lacquered, Metal black or Matt chrome

Fabric group 1	8.362
Fabric group 2	9.142
Fabric group 3	10.163
Fabric group 4	11.910
Fabric group 5	14.112
C.O.M. fabric	8.362

Fabric consumption: 13,94 m

Note - Complementary cushions are ordered separately (P5522).

Certifications

FSC® certified

EN 1022:2005, EN 16139:2013 (L2)

Recommended upholstery

Fabric group 1	Grand Linen, Linara, Bardal, Capture, Remix, Natural Linen, Re-wool, Ruskin, Erik
Fabric group 2	Hallingdal, Harald, Savoy, Clay, Barnum, Sunniva, Steelcut Trio, Fiord, Foss, Loop
Fabric group 3	Vidar, Divina Melange, Elle, Cotil
Fabric group 4	Sisu, Safire
Fabric group 5	Gentle

Model 562F

Calmo Elements Configuration F, 253 x 174cm

Modeldetails

2,14 m³
149 kg /
130 kg



Designed by Hugo Passos, 2022

Sofa with separate seat and back cushions. Inner frame of wood with nozag springs. Available in fabric. Cushions available in foam core with down wrap or solid foam (CMHR or HR). External cover is non-removable. Cushion covers are removable. Leg trestles in solid wood or steel. Mounted with plastic glides. Felt glides available.



Order configuration

Leg trestles: Oak lacquered, Smoked oak stained lacquered, Metal black or Matt chrome

Fabric group 1	8.362
Fabric group 2	9.142
Fabric group 3	10.163
Fabric group 4	11.910
Fabric group 5	14.112
C.O.M. fabric	8.362

Fabric consumption: 13,94 m

Note - Complementary cushions are ordered separately (P5522).

Certifications

FSC® certified

EN 1022:2005, EN 16139:2013 (L2)

Recommended upholstery

Fabric group 1	Grand Linen, Linara, Bardal, Capture, Remix, Natural Linen, Re-wool, Ruskin, Erik
Fabric group 2	Hallingdal, Harald, Savoy, Clay, Barnum, Sunniva, Steelcut Trio, Fiord, Foss, Loop
Fabric group 3	Vidar, Divina Melange, Elle, Cotil
Fabric group 4	Sisu, Safire
Fabric group 5	Gentle

Model 562G

Calmo Elements Configuration G, 417 x 333cm

Modeldetails

5,14 m³
329 kg /
268 kg



Designed by Hugo Passos, 2022

Sofa with separate seat and back cushions. Inner frame of wood with nozag springs. Available in fabric. Cushions available in foam core with down wrap or solid foam (CMHR or HR). External cover is non-removable. Cushion covers are removable. Leg trestles in solid wood or steel. Mounted with plastic glides. Felt glides available.



Order configuration

Leg trestles: Oak lacquered, Smoked oak stained lacquered, Metal black or Matt chrome

Fabric group 1	17.103
Fabric group 2	18.364
Fabric group 3	20.753
Fabric group 4	24.476
Fabric group 5	29.179
C.O.M. fabric	17.103

Fabric consumption: 31,53 m

Note - Complementary cushions are ordered separately (P5522).

Certifications

FSC® certified

EN 1022:2005, EN 16139:2013 (L2)

Recommended upholstery

Fabric group 1	Grand Linen, Linara, Bardal, Capture, Remix, Natural Linen, Re-wool, Ruskin, Erik
Fabric group 2	Hallingdal, Harald, Savoy, Clay, Barnum, Sunniva, Steelcut Trio, Fiord, Foss, Loop
Fabric group 3	Vidar, Divina Melange, Elle, Cotil
Fabric group 4	Sisu, Safire
Fabric group 5	Gentle

Model 562H

Calmo Elements Configuration H, 417 x 333cm

Modeldetails

5,14 m³

329 kg /
268 kg



Designed by Hugo Passos, 2022

Sofa with separate seat and back cushions. Inner frame of wood with nozag springs. Available in fabric. Cushions available in foam core with down wrap or solid foam (CMHR or HR). External cover is non-removable. Cushion covers are removable. Leg trestles in solid wood or steel. Mounted with plastic glides. Felt glides available.



Order configuration

Leg trestles: Oak lacquered, Smoked oak stained lacquered, Metal black or Matt chrome

Fabric group 1	15.637
Fabric group 2	16.693
Fabric group 3	18.877
Fabric group 4	22.220
Fabric group 5	26.484
C.O.M. fabric	15.637

Fabric consumption: 31,53 m

Note - Complementary cushions are ordered separately (P5522).

Certifications

FSC® certified

EN 1022:2005, EN 16139:2013 (L2)

Recommended upholstery

Fabric group 1	Grand Linen, Linara, Bardal, Capture, Remix, Natural Linen, Re-wool, Ruskin, Erik
Fabric group 2	Hallingdal, Harald, Savoy, Clay, Barnum, Sunniva, Steelcut Trio, Fiord, Foss, Loop
Fabric group 3	Vidar, Divina Melange, Elle, Cotil
Fabric group 4	Sisu, Safire
Fabric group 5	Gentle

Calmo Elements - Overview

Model 562A, Configuration A

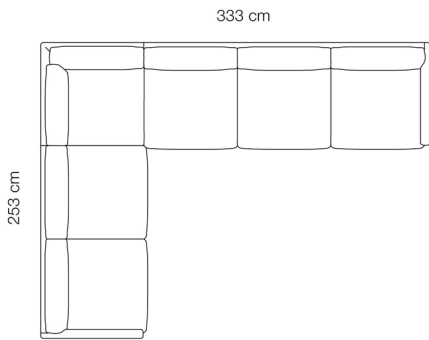

Model 562B, Configuration B

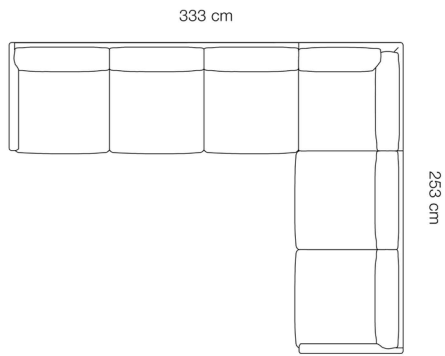

Model 562C, Configuration C

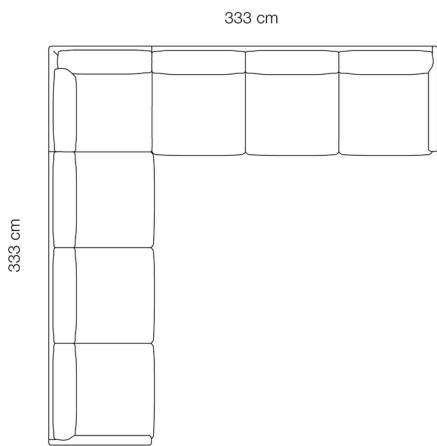

Model 562D, Configuration D

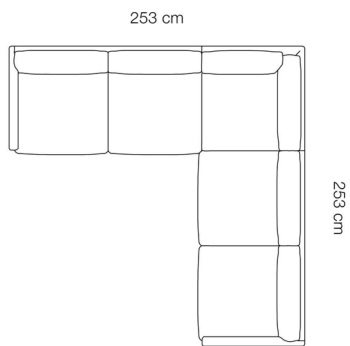

Model 562E, Configuration E

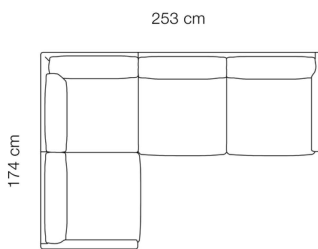

Model 562F, Configuration F

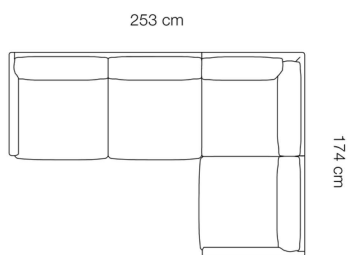

Model 562G, Configuration G

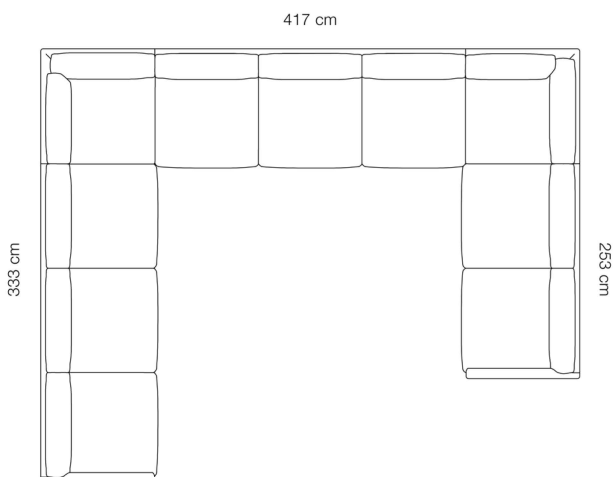

Model 562H, Configuration H

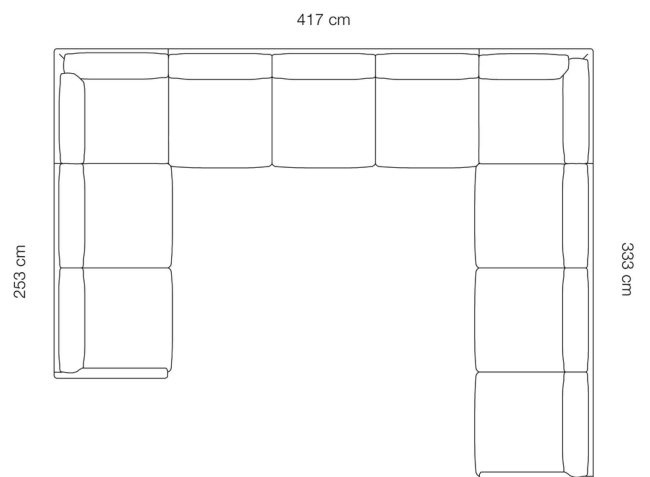

Model 4510

Delphi Sofa 205x85 cm



Designed by Hannes Wettstein, 2007

Fully upholstered sofa. Inner frame of wood with nozag springs, cold cured foam and duvet of down and foam granulate mixture. Available in fabric or leather. Aluminum or solid wood base.

Modeldetails

1,3 m³ Packaging dimensions:
100 kg / 90 kg L: 210 cm W: 95 cm H: 64 cm

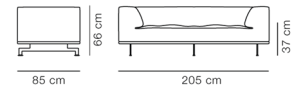

Essential Assortment

Item number	Upholstery	Legs	Price
45100401009098510100	Steelcut Trio, 213	Brushed aluminium	4.999
45105009809098510100	Leather Max 98, Black	Brushed aluminium	9.349
45105084109098510100	Leather Cera 905, Russet brown	Brushed aluminium	10.199

Essential variants only delivered with HR foam

Order configuration

Plinth: Oak light oil or same as other upholstery or leather (98 black, 95 cognac, 90 natural).

	Brushed aluminium	Oak light oil
Fabric group 1	5.241	5.241
Fabric group 2	5.667	5.667
Fabric group 3	5.873	5.873
Fabric group 4	6.488	6.488
Fabric group 5	7.786	7.786
C.O.M. fabric	5.241	5.241
Leather group 1	8.156	8.156
Leather group 2	9.062	9.062
Leather group 3	10.471	10.471
Leather group 4	11.170	11.170
Leather group 5	12.846	12.846
C.O.M. leather	8.156	8.156

Fabric consumption: 5,8 m. Leather consumption: 16,5 m²

Leather consumption plinth: 2,25 m²

Extra charge for

Leather plinth if upholstery is in fabric:	+832
Extra sitting height (2,5 cm):	+206
Legs in steel, black:	+206

Recommended upholstery

Fabric group 1	Grand Linen, Remix, Capture, Bardal, Re-wool, Linara, Ruskin, Natural Linen, Erik
Fabric group 2	Hallingdal, Barnum, Loop, Steelcut Trio, Foss, Fiord, Clay
Fabric group 3	Divina Melange, Elle, Vidar
Fabric group 4	Sisu, Safire
Fabric group 5	Gentle
Leather group 1	Omni
Leather group 2	Primo, Trace
Leather group 3	Max
Leather group 4	Nubuck, Vegeta, Organic, Cera

Model 4511

Delphi Sofa 240x85 cm



Designed by Hannes Wettstein, 2007

Fully upholstered sofa. Inner frame of wood with nozag springs, cold cured foam and duvet of down and foam granulate mixture. Available in fabric or leather. Aluminum or solid wood base.

Modeldetails

1,5 m³ Packaging dimensions:
110 kg / 100 kg L: 245 cm W: 95 cm H: 64 cm

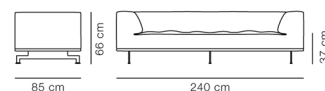

Essential Assortment

Item number	Upholstery	Legs	Price
45110401009098510100	Steelcut Trio, 213	Brushed aluminium	5.524
45115009809098510100	Leather Max 98, Black	Brushed aluminium	10.199
45115084109098510100	Leather Cera 905, Russet brown	Brushed aluminium	11.050

Essential variants only delivered with HR foam

Order configuration

Plinth: Oak light oil or same as other upholstery or leather (98 black, 95 cognac, 90 natural).

	Brushed aluminium	Oak light oil
Fabric group 1	5.605	5.605
Fabric group 2	6.054	6.054
Fabric group 3	6.270	6.270
Fabric group 4	6.918	6.918
Fabric group 5	8.302	8.302
C.O.M. fabric	5.605	5.605
Leather group 1	8.652	8.652
Leather group 2	9.602	9.602
Leather group 3	11.079	11.079
Leather group 4	11.811	11.811
Leather group 5	13.583	13.583
C.O.M. leather	8.652	8.652

Fabric consumption: 6,5 m. Leather consumption: 20 m²

Leather consumption plinth: 2,25 m²

Extra charge for

Leather plinth if upholstery is in fabric:	+832
Extra sitting height (2,5 cm):	+206
Legs in steel, black:	+206

Recommended upholstery

Fabric group 1	Grand Linen, Remix, Capture, Bardal, Re-wool, Linara, Ruskin, Natural Linen, Erik
Fabric group 2	Hallingdal, Barnum, Loop, Steelcut Trio, Foss, Fiord, Clay
Fabric group 3	Divina Melange, Elle, Vidar
Fabric group 4	Sisu, Safire
Fabric group 5	Gentle
Leather group 1	Omni
Leather group 2	Primo, Trace
Leather group 3	Max
Leather group 4	Nubuck, Vegeta, Organic, Cera

Model 4512

Delphi Sofa 325x85 cm

Modeldetails

2,7 m³ Packaging dimensions:
185 kg / L: 335 cm W: 95 cm H: 85 cm
120 kg



Designed by Hannes Wettstein, 2007

Fully upholstered sofa. Inner frame of wood with nozag springs, cold cured foam and duvet of down and foam granulate mixture. Available in fabric or leather. Aluminum or solid wood base.

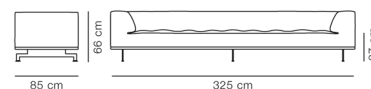

Essential Assortment

Item number	Upholstery	Legs	Price
45120401009098510100	Steelcut Trio, 213	Brushed aluminium	7.649
45125009809098510100	Leather Max 98, Black	Brushed aluminium	16.150
45125084109098510100	Leather Cera 905, Russet brown	Brushed aluminium	16.999

Essential variants only delivered with HR foam

Order configuration

Plinth: Oak light oil or same as other upholstery or leather (98 black, 95 cognac, 90 natural).

	Brushed aluminium	Oak light oil
Fabric group 1	7.790	7.790
Fabric group 2	8.460	8.460
Fabric group 3	8.782	8.782
Fabric group 4	9.747	9.747
Fabric group 5	11.697	11.697
C.O.M. fabric	7.790	7.790
Leather group 1	12.851	12.851
Leather group 2	14.325	14.325
Leather group 3	16.617	16.617
Leather group 4	17.754	17.754
Leather group 5	20.417	20.417
C.O.M. leather	12.851	12.851

Fabric consumption: 8,5 m. Leather consumption: 22 m²

Leather consumption plinth: 2,25 m²

Extra charge for

Leather plinth if upholstery is in fabric:	+832
Extra sitting height (2,5 cm):	+206
Legs in steel, black:	+206

Recommended upholstery

Fabric group 1	Grand Linen, Remix, Capture, Bardal, Re-wool, Linara, Ruskin, Natural Linen, Erik
Fabric group 2	Hallingdal, Barnum, Loop, Steelcut Trio, Foss, Fiord, Clay
Fabric group 3	Divina Melange, Elle, Vidar
Fabric group 4	Sisu, Safire
Fabric group 5	Gentle
Leather group 1	Omni
Leather group 2	Primo, Trace
Leather group 3	Max
Leather group 4	Nubuck, Vegeta, Organic, Cera

Model 4513

Delphi Elements Corner module 85x85 cm



Designed by Hannes Wettstein, 2007

Square corner module for Delphi modular sofa system. Fully upholstered in fabric or leather. Inner frame of wood with nozag springs, cold cured foam and duvet of down and foam granulate mixture. Aluminum or solid wood base. Modules can be independently rearranged.

Model details

0,6 m³ Packaging dimensions:
50 kg / 45 kg L: 101 cm W: 95 cm H: 64 cm

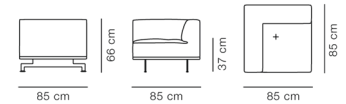

Order configuration

Plinth: Oak light oil or same as other upholstery or leather (98 black, 95 cognac, 90 natural).

	Brushed aluminium	Oak light oil
Fabric group 1	2.683	2.683
Fabric group 2	2.907	2.907
Fabric group 3	3.015	3.015
Fabric group 4	3.339	3.339
Fabric group 5	4.007	4.007
C.O.M. fabric	2.683	2.683
Leather group 1	4.222	4.222
Leather group 2	4.700	4.700
Leather group 3	5.442	5.442
Leather group 4	5.810	5.810
Leather group 5	6.682	6.682
C.O.M. leather	4.222	4.222

Fabric consumption: 3,5 m. Leather consumption: 7,5 m²

Leather consumption plinth: 2,25 m²

Extra charge for

Leather plinth if upholstery is in fabric:	+416
Extra sitting height (2,5 cm):	+206
Legs in steel, black:	+206

Recommended upholstery

Fabric group 1	Grand Linen, Remix, Capture, Bardal, Re-wool, Linara, Ruskin, Natural Linen, Erik
Fabric group 2	Hallingdal, Loop, Steelcut Trio, Foss, Fiord, Clay, Barnum
Fabric group 3	Divina Melange, Elle, Vidar
Fabric group 4	Sisu, Safire
Fabric group 5	Gentle
Leather group 1	Omni
Leather group 2	Primo, Trace
Leather group 3	Max
Leather group 4	Nubuck, Vegeta, Organic, Cera

Model 4501

Delphi Elements End module 120x85 cm, Arm L or R



Designed by Hannes Wettstein, 2007

Rectangular end module for Delphi modular sofa system. Fully upholstered in fabric or leather. Inner frame of wood with nozag springs, cold cured foam and duvet of down and foam granulate mixture. Aluminum or solid wood base. Modules can be independently rearranged. Please specify right- or left-hand corner.

Modeldetails

0,8 m³ Packaging dimensions:
65 kg / 60 kg L: 125 cm W: 95 cm H: 64 cm

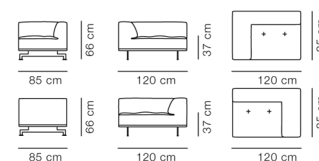

Order configuration

Plinth: Oak light oil or same as other upholstery or leather (98 black, 95 cognac, 90 natural).
Right or left hand arm.

	Brushed aluminium	Oak light oil
Fabric group 1	3.003	3.003
Fabric group 2	3.272	3.272
Fabric group 3	3.402	3.402
Fabric group 4	3.791	3.791
Fabric group 5	4.549	4.549
C.O.M. fabric	3.003	3.003
Leather group 1	4.845	4.845
Leather group 2	5.415	5.415
Leather group 3	6.301	6.301
Leather group 4	6.740	6.740
Leather group 5	7.751	7.751
C.O.M. leather	4.845	4.845

Fabric consumption: 4,2 m. Leather consumption: 10 m²

Leather consumption plinth: 2,25 m²

Extra charge for

Leather plinth if upholstery is in fabric:	+416
Extra sitting height (2,5 cm):	+206
Legs in steel, black:	+206

Recommended upholstery

Fabric group 1	Grand Linen, Remix, Capture, Bardal, Re-wool, Linara, Ruskin, Natural Linen, Erik
Fabric group 2	Hallingdal, Barnum, Loop, Steelcut Trio, Foss, Fiord, Clay
Fabric group 3	Divina Melange, Elle, Vidar
Fabric group 4	Sisu, Safire
Fabric group 5	Gentle
Leather group 1	Omni
Leather group 2	Primo, Trace
Leather group 3	Max
Leather group 4	Nubuck, Vegeta, Organic, Cera

Model 4514

Delphi Elements End module 180x85 cm, Arm L or R



Designed by Hannes Wettstein, 2007

Long rectangular end module for Delphi modular sofa system. Fully upholstered in fabric or leather. Inner frame of wood with nozag springs, cold cured foam and duvet of down and foam granulate mixture. Aluminum or solid wood base. Modules can be independently rearranged. Please specify right- or left-hand corner.

Modeldetails

1,1 m³ Packaging dimensions:
85 kg / 80 kg L: 185 cm W: 95 cm H: 64 cm

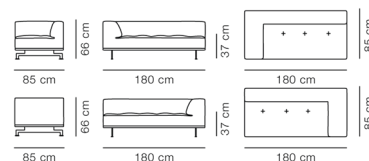

Order configuration

Plinth: Oak light oil or same as other upholstery or leather (98 black, 95 cognac, 90 natural).
Right or left hand arm.

	Brushed aluminium	Oak light oil
Fabric group 1	3.625	3.625
Fabric group 2	3.962	3.962
Fabric group 3	4.124	4.124
Fabric group 4	4.610	4.610
Fabric group 5	5.532	5.532
C.O.M. fabric	3.625	3.625
Leather group 1	5.904	5.904
Leather group 2	6.610	6.610
Leather group 3	7.707	7.707
Leather group 4	8.251	8.251
Leather group 5	9.488	9.488
C.O.M. leather	5.904	5.904

Fabric consumption: 5,3 m. Leather consumption: 12,5 m²

Leather consumption plinth: 2,25 m²

Extra charge for

Leather plinth if upholstery is in fabric:	+416
Extra sitting height (2,5 cm):	+206
Legs in steel, black:	+206

Recommended upholstery

Fabric group 1	Grand Linen, Remix, Capture, Bardal, Re-wool, Linara, Ruskin, Natural Linen, Erik
Fabric group 2	Hallingdal, Barnum, Loop, Steelcut Trio, Foss, Fiord, Clay
Fabric group 3	Divina Melange, Elle, Vidar
Fabric group 4	Sisu, Safire
Fabric group 5	Gentle
Leather group 1	Omni
Leather group 2	Primo, Trace
Leather group 3	Max
Leather group 4	Nubuck, Vegeta, Organic, Cera

Model 4504

Delphi Elements Ottoman 120x85 cm



Designed by Hannes Wettstein, 2007

Ottoman with inner frame of wood, cold cured foam and foam duvet. Fully upholstered in fabric or leather. Inner frame of wood with nozag springs, cold cured foam and duvet of down and foam granulate mixture. Aluminum or solid wood base. Can be used as part of modular configuration. Modules can be independently rearranged.

Modeldetails

0,6 m³ Packaging dimensions:
52 kg / 47 kg L: 125 cm W: 88 cm H: 52 cm

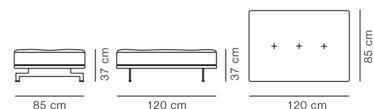

Essential Assortment

Item number	Upholstery	Legs	Price
45040401009098510100	Steelcut Trio, 213	Brushed aluminium	2.083
45045009809098510100	Leather Max 98, Black	Brushed aluminium	3.749
45045084109098510100	Leather Cera 905, Russet brown	Brushed aluminium	4.166

Essential variants only delivered with HR foam

Order configuration

Plinth: Oak light oil or same as other upholstery or leather (98 black, 95 cognac, 90 natural).

	Brushed aluminium	Oak light oil
Fabric group 1	1.989	1.989
Fabric group 2	2.170	2.170
Fabric group 3	2.258	2.258
Fabric group 4	2.519	2.519
Fabric group 5	3.023	3.023
C.O.M. fabric	1.989	1.989
Leather group 1	3.237	3.237
Leather group 2	3.622	3.622
Leather group 3	4.221	4.221
Leather group 4	4.518	4.518
Leather group 5	5.195	5.195
C.O.M. leather	3.237	3.237

Fabric consumption: 2,6 m. Leather consumption: 6,5 m²

Leather consumption plinth: 2,25 m²

Extra charge for

Leather plinth if upholstery is in fabric:	+416
Extra sitting height (2,5 cm):	+206
Legs in steel, black:	+206

Recommended upholstery

Fabric group 1	Grand Linen, Remix, Capture, Bardal, Re-wool, Linara, Ruskin, Natural Linen, Erik
Fabric group 2	Hallingdal, Barnum, Loop, Steelcut Trio, Foss, Fiord, Clay
Fabric group 3	Divina Melange, Elle, Vidar
Fabric group 4	Sisu, Safire
Fabric group 5	Gentle
Leather group 1	Omni
Leather group 2	Primo, Trace
Leather group 3	Max
Leather group 4	Nubuck, Vegeta, Organic, Cera

Model 4505

Delphi Elements Ottoman 85x85 cm



Designed by Hannes Wettstein, 2007

Ottoman with inner frame of wood, cold cured foam and foam duvet. Fully upholstered in fabric or leather. Inner frame of wood with nozag springs, cold cured foam and duvet of down and foam granulate mixture. Aluminum or solid wood base. Can be used as part of modular configuration. Modules can be independently rearranged.

Modeldetails

0,4 m³ Packaging dimensions:
30 kg / 25 kg L: 95 cm W: 85 cm H: 52 cm

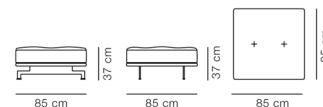

Essential Assortment

Item number	Upholstery	Legs	Price
45050401009098510100	Steelcut Trio, 213	Brushed aluminium	1.832
45055009809098510100	Leather Max 98, Black	Brushed aluminium	3.249
45055084109098510100	Leather Cera 905, Russet brown	Brushed aluminium	3.666

Essential variants only delivered with HR foam

Order configuration

Plinth: Oak light oil or same as other upholstery or leather (98 black, 95 cognac, 90 natural).

	Brushed aluminium	Oak light oil
Fabric group 1	1.860	1.860
Fabric group 2	1.998	1.998
Fabric group 3	2.065	2.065
Fabric group 4	2.265	2.265
Fabric group 5	2.719	2.719
C.O.M. fabric	1.860	1.860
Leather group 1	2.817	2.817
Leather group 2	3.115	3.115
Leather group 3	3.579	3.579
Leather group 4	3.809	3.809
Leather group 5	4.381	4.381
C.O.M. leather	2.817	2.817

Fabric consumption: 1,9 m. Leather consumption: 6 m²

Leather consumption plinth: 2,25 m²

Extra charge for

Leather plinth if upholstery is in fabric:	+416
Extra sitting height (2,5 cm):	+206
Legs in steel, black:	+206

Recommended upholstery

Fabric group 1	Grand Linen, Remix, Capture, Bardal, Re-wool, Linara, Ruskin, Natural Linen, Erik
Fabric group 2	Hallingdal, Barnum, Loop, Steelcut Trio, Foss, Fiord, Clay
Fabric group 3	Divina Melange, Elle, Vidar
Fabric group 4	Sisu, Safire
Fabric group 5	Gentle
Leather group 1	Omni
Leather group 2	Primo, Trace
Leather group 3	Max
Leather group 4	Nubuck, Vegeta, Organic, Cera

Model 4502

Delphi Elements Seat module 120x85 cm



Designed by Hannes Wettstein, 2007

Wide seat module for Delphi modular sofa system. Fully upholstered in fabric or leather. Inner frame of wood with nozag springs, cold cured foam and duvet of down and foam granulate mixture. Aluminum or solid wood base. Modules can be independently rearranged.

Modeldetails

0,8 m³ Packaging dimensions:
59 kg / 54 kg L: 125 cm W: 95 cm H: 64 cm

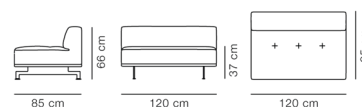

Order configuration

Plinth: Oak light oil or same as other upholstery or leather (98 black, 95 cognac, 90 natural).

	Brushed aluminium	Oak light oil
Fabric group 1	2.425	2.425
Fabric group 2	2.653	2.653
Fabric group 3	2.763	2.763
Fabric group 4	3.091	3.091
Fabric group 5	3.710	3.710
C.O.M. fabric	2.425	2.425
Leather group 1	4.015	4.015
Leather group 2	4.503	4.503
Leather group 3	5.263	5.263
Leather group 4	5.639	5.639
Leather group 5	6.485	6.485
C.O.M. leather	4.015	4.015

Fabric consumption: 3,6 m. Leather consumption: 10 m²

Leather consumption plinth: 2,25 m²

Extra charge for

Leather plinth if upholstery is in fabric:	+416
Extra sitting height (2,5 cm):	+206
Legs in steel, black:	+206

Recommended upholstery

Fabric group 1	Grand Linen, Remix, Capture, Bardal, Re-wool, Linara, Ruskin, Natural Linen, Erik
Fabric group 2	Hallingdal, Barnum, Loop, Steelcut Trio, Foss, Fiord, Clay
Fabric group 3	Divina Melange, Elle, Vidar
Fabric group 4	Sisu, Safire
Fabric group 5	Gentle
Leather group 1	Omni
Leather group 2	Primo, Trace
Leather group 3	Max
Leather group 4	Nubuck, Vegeta, Organic, Cera

Model 4506

Delphi Elements Seat module 85x85 cm



Designed by Hannes Wettstein, 2007

Short seat module for Delphi modular sofa system. Fully upholstered in fabric or leather. Inner frame of wood with nozag springs, cold cured foam and duvet of down and foam granulate mixture. Aluminum or solid wood base. Modules can be independently rearranged.

Modeldetails

0,6 m³ Packaging dimensions:
45 kg / 40 kg L: 100 cm W: 95 cm H: 64 cm

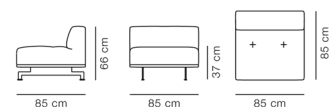

Order configuration

Plinth: Oak light oil or same as other upholstery or leather (98 black, 95 cognac, 90 natural).

	Brushed aluminium	Oak light oil
Fabric group 1	2.173	2.173
Fabric group 2	2.352	2.352
Fabric group 3	2.439	2.439
Fabric group 4	2.698	2.698
Fabric group 5	3.237	3.237
C.O.M. fabric	2.173	2.173
Leather group 1	3.409	3.409
Leather group 2	3.793	3.793
Leather group 3	4.389	4.389
Leather group 4	4.685	4.685
Leather group 5	5.387	5.387
C.O.M. leather	3.409	3.409

Fabric consumption: 2,9 m. Leather consumption: 7,5 m²

Leather consumption plinth: 2,25 m²

Extra charge for

Leather plinth if upholstery is in fabric:	+416
Extra sitting height (2,5 cm):	+206
Legs in steel, black:	+206

Recommended upholstery

Fabric group 1	Grand Linen, Remix, Capture, Bardal, Re-wool, Linara, Ruskin, Natural Linen, Erik
Fabric group 2	Hallingdal, Barnum, Loop, Steelcut Trio, Foss, Fiord, Clay
Fabric group 3	Divina Melange, Elle, Vidar
Fabric group 4	Sisu, Safire
Fabric group 5	Gentle
Leather group 1	Omni
Leather group 2	Primo, Trace
Leather group 3	Max
Leather group 4	Nubuck, Vegeta, Organic, Cera

Model 4503

Delphi Elements Side chaise module 120x85 cm



Designed by Hannes Wettstein, 2007

Side module with extended depth for L-configuration of Delphi modular sofa. Fully upholstered in fabric or leather. Inner frame of wood with nozag springs, cold cured foam and duvet of down and foam granulate mixture. Aluminum or solid wood base. The backrest of the module is designed to be used in connection with main sofa armrest. Modules can be independently rearranged.

Model details

0,8 m³ Packaging dimensions:
59 kg / 54 kg L: 125 cm W: 95 cm H: 64 cm

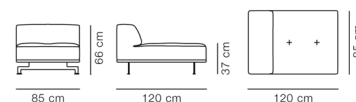

Order configuration

Plinth: Oak light oil or same as other upholstery or leather (98 black, 95 cognac, 90 natural).

	Brushed aluminium	Oak light oil
Fabric group 1	2.400	2.400
Fabric group 2	2.612	2.612
Fabric group 3	2.714	2.714
Fabric group 4	3.019	3.019
Fabric group 5	3.623	3.623
C.O.M. fabric	2.400	2.400
Leather group 1	3.857	3.857
Leather group 2	4.308	4.308
Leather group 3	5.008	5.008
Leather group 4	5.355	5.355
Leather group 5	6.159	6.159
C.O.M. leather	3.857	3.857

Fabric consumption: 3,3 m. Leather consumption: 10 m²

Leather consumption plinth: 2,25 m²

Extra charge for

Leather plinth if upholstery is in fabric:	+416
Extra sitting height (2,5 cm):	+206
Legs in steel, black:	+206

Recommended upholstery

Fabric group 0	Connect
Fabric group 1	Grand Linen, Linara, Bardal, Capture, Remix, Re-wool, Ruskin, Erik
Fabric group 2	Hallingdal, Clay, Barnum, Steelcut Trio, Fiord, Foss, Loop
Fabric group 3	Vidar, Divina Melange, Elle
Fabric group 4	Sisu, Safire
Fabric group 5	Gentle
Leather group 4	Cera

Model P4500

Delphi Accessories Cushion

Modeldetails



Designed by Hannes Wettstein, 2007

Loose back cushions in foam core with down wrap available in textile or leather. Available in two sizes. The smallest available with a steel frame to avoid the cushion skidding when upholstered in leather.

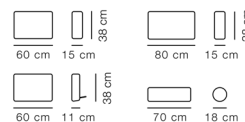

Essential Assortment

Item number	Upholstery	Cushion	Cushion	Price
P450004010011100	Steelcut Trio, 213	Cushion wall-edged	H38 x W60 x D15 cm	295
P450004010011200	Steelcut Trio, 213	Cushion wall-edged	H38 x W80 x D15 cm	295
P450050098011100	Leather Max 98, Black	Cushion wall-edged	H38 x W60 x D15 cm	616
P450050098011200	Leather Max 98, Black	Cushion wall-edged	H38 x W80 x D15 cm	616
P450050841011100	Leather Cera 905, Russet brown	Cushion wall-edged	H38 x W60 x D15 cm	666
P450050841011200	Leather Cera 905, Russet brown	Cushion wall-edged	H38 x W80 x D15 cm	666

Essential variants only delivered with HR foam

Order configuration

	Short cushion 38 x 60 cm	Short cushion w. bracket 38 x 60 cm	Long cushion 38 x 80 cm	Neck cushion Ø18 x 70 cm
Fabric group 1	258	317	294	280
Fabric group 2	307	366	357	333
Fabric group 3	331	389	387	358
Fabric group 4	401	460	476	433
Fabric group 5	482	552	571	520
C.O.M. fabric	258	317	294	280
Leather group 1	472	666	556	557
Leather group 2	544	772	645	646
Leather group 3	656	935	783	784
Leather group 4	712	1.016	851	852
Leather group 5	818	1.169	979	980
C.O.M. leather	472	666	556	557

Fabric and leather consumption:

Short cushion, 0,75 m / 1,2 m², Long cushion, 0,95 m / 2,0 m²

Back cushion, 0,75 m / 1,2 m², Neck cushion, 0,80 m / 1,5 m²

Recommended upholstery

Fabric group 1	Grand Linen, Linara, Bardal, Capture, Remix, Re-wool, Ruskin, Natural Linen, Erik
Fabric group 2	Hallingdal, Clay, Barnum, Steelcut Trio, Fiord, Foss, Loop
Fabric group 3	Vidar, Divina Melange, Elle
Fabric group 4	Sisu, Safire
Fabric group 5	Gentle
Leather group 1	Omni
Leather group 2	Primo, Trace
Leather group 3	Max
Leather group 4	Nubuck, Vegeta, Organic, Cera

Model 450A

Delphi Elements Configuration A, 325 x 170cm

Model details

2,8 m ³	Packaging dimensions:
227 kg / 207 kg	L: 125/125/100/125 cm W: 88/95/95/95 cm H: 52/64/64/64 cm



Designed by Hannes Wettstein, 2007

Delphi modular sofa system. Fully upholstered in fabric or leather. Inner frame of wood with nozag springs, cold cured foam and duvet of down and foam granulate mixture. Aluminum or solid wood base. Modules can be independently rearranged.

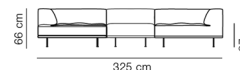

Essential Assortment

Item number	Upholstery	Legs	Price
450A0401009000510100	Steelcut Trio, 213	Brushed aluminium	9.438
450A5009809000510100	Leather Max 98, Black	Brushed aluminium	17.198
450A5084109000510100	Leather Cera 905, Russet brown	Brushed aluminium	18.798

Essential variants only delivered with HR foam

Order configuration

Base: Brushed aluminium or Oak light oil

Fabric group 1	10.168
Fabric group 2	11.066
Fabric group 3	11.501
Fabric group 4	12.799
Fabric group 5	15.358
C.O.M. fabric	10.168
Leather group 1	16.336
Leather group 2	18.245
Leather group 3	21.212
Leather group 4	22.683
Leather group 5	26.084
C.O.M. leather	16.336

Fabric consumption: 13,9 m. Leather consumption: 34 m²

Extra charge for

Leather plinth if upholstery is in fabric:	+1.664
Extra sitting height (2,5 cm):	+824
Legs in steel, black:	+824

Recommended upholstery

Fabric group 1	Grand Linen, Linara, Bardal, Capture, Remix, Re-wool, Ruskin, Natural Linen, Erik
Fabric group 2	Hallingdal, Clay, Barnum, Steelcut Trio, Fiord, Foss, Loop
Fabric group 3	Vidar, Divina Melange, Elle
Fabric group 4	Sisu, Safire
Fabric group 5	Gentle
Leather group 1	Omni
Leather group 2	Primo, Trace
Leather group 3	Max
Leather group 4	Nubuck, Vegeta, Organic, Cera

Model 450B

Delphi Elements Configuration B, 265 x 205cm

Modeldetails

📦 2,5 m³	Packaging dimensions:
📏 200 kg / 185 kg	L: 125/101/185 cm W: 95/95/95 cm H: 64/64/64 cm

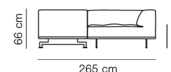

Designed by Hannes Wettstein, 2007

Delphi modular sofa system. Fully upholstered in fabric or leather. Inner frame of wood with nozag springs, cold cured foam and duvet of down and foam granulate mixture. Aluminum or solid wood base. Modules can be independently rearranged.

Essential Assortment

Item number	Upholstery	Legs	Price
450B0401009000510100	Steelcut Trio, 213	Brushed aluminium	9.083
450B5009809000510100	Leather Max 98, Black	Brushed aluminium	15.999
450B5084109000510100	Leather Cera 905, Russet brown	Brushed aluminium	17.666

Essential variants only delivered with HR foam

Order configuration

Base: Brushed aluminium or Oak light oil

Fabric group 1	9.311
Fabric group 2	10.141
Fabric group 3	10.541
Fabric group 4	11.740
Fabric group 5	14.088
C.O.M. fabric	9.311
Leather group 1	14.971
Leather group 2	16.725
Leather group 3	19.450
Leather group 4	20.801
Leather group 5	23.921
C.O.M. leather	14.971

Fabric consumption: 13 m. Leather consumption: 30 m²

Extra charge for

Leather plinth if upholstery is in fabric:	+1.248
Extra sitting height (2,5 cm):	+618
Legs in steel, black:	+618

Recommended upholstery

Fabric group 1	Grand Linen, Linara, Bardal, Capture, Remix, Re-wool, Ruskin, Natural Linen, Erik
Fabric group 2	Hallingdal, Clay, Barnum, Steelcut Trio, Fiord, Foss, Loop
Fabric group 3	Vidar, Divina Melange, Elle
Fabric group 4	Sisu, Safire
Fabric group 5	Gentle
Leather group 1	Omni
Leather group 2	Primo, Trace
Leather group 3	Max
Leather group 4	Nubuck, Vegeta, Organic, Cera

Model 450D

Delphi Elements Configuration D, 265 x 205cm



Designed by Hannes Wettstein, 2007

Delphi modular sofa system. Fully upholstered in fabric or leather. Inner frame of wood with nozag springs, cold cured foam and duvet of down and foam granulate mixture. Aluminum or solid wood base. Modules can be independently rearranged.

Modeldetails

📦 2,5 m³	Packaging dimensions:
📦 307 kg / 282 kg	L: 185/101/125 cm W: 95/95/95 cm H: 64/64/64 cm

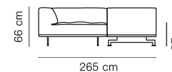

Essential Assortment

Item number	Upholstery	Legs	Price
450D0401009000510100	Steelcut Trio, 213	Brushed aluminium	9.083
450D5009809000510100	Leather Max 98, Black	Brushed aluminium	15.999
450D5084109000510100	Leather Cera 905, Russet brown	Brushed aluminium	17.666

Essential variants only delivered with HR foam

Order configuration

Base: Brushed aluminium or Oak light oil

Fabric group 1	9.311
Fabric group 2	10.141
Fabric group 3	10.541
Fabric group 4	11.740
Fabric group 5	14.088
C.O.M. fabric	9.311
Leather group 1	14.971
Leather group 2	16.725
Leather group 3	19.450
Leather group 4	20.801
Leather group 5	23.921
C.O.M. leather	14.971

Fabric consumption: 18,6 m. Leather consumption: 50 m²

Extra charge for

Leather plinth if upholstery is in fabric:	+2.080
Extra sitting height (2,5 cm):	+618
Legs in steel, black:	+618

Recommended upholstery

Fabric group 1	Grand Linen, Linara, Bardal, Capture, Remix, Re-wool, Ruskin, Natural Linen, Erik
Fabric group 2	Hallingdal, Clay, Barnum, Steelcut Trio, Fiord, Foss, Loop
Fabric group 3	Vidar, Divina Melange, Elle
Fabric group 4	Sisu, Safire
Fabric group 5	Gentle
Leather group 1	Omni
Leather group 2	Primo, Trace
Leather group 3	Max
Leather group 4	Nubuck, Vegeta, Organic, Cera

Model 450C

Delphi Elements Configuration C, 360 x 255cm

Modeldetails

4 m³ Packaging dimensions:
200 kg / 185 kg L: 125/125/125/125/125 cm W:
95/95/95/95/95 cm H: 64/64/64/64/6



Designed by Hannes Wettstein, 2007

Delphi modular sofa system. Fully upholstered in fabric or leather. Inner frame of wood with nozag springs, cold cured foam and duvet of down and foam granulate mixture. Aluminum or solid wood base. Modules can be independently rearranged.



Essential Assortment

Item number	Upholstery	Legs	Price
450C0401009000510100	Steelcut Trio, 213	Brushed aluminium	12.833
450C5009809000510100	Leather Max 98, Black	Brushed aluminium	23.583
450C5084109000510100	Leather Cera 905, Russet brown	Brushed aluminium	25.666

Essential variants only delivered with HR foam

Order configuration

Base: Brushed aluminium or Oak light oil

Fabric group 1	13.231
Fabric group 2	14.421
Fabric group 3	14.995
Fabric group 4	16.711
Fabric group 5	20.054
C.O.M. fabric	13.231
Leather group 1	21.419
Leather group 2	23.949
Leather group 3	27.881
Leather group 4	29.829
Leather group 5	34.305
C.O.M. leather	21.419

Fabric consumption: 13 m. Leather consumption: 30 m²

Extra charge for

Leather plinth if upholstery is in fabric:	+2.080
Extra sitting height (2,5 cm):	+1.030
Legs in steel, black:	+1.030

Recommended upholstery

Fabric group 1	Grand Linen, Linara, Bardal, Capture, Remix, Re-wool, Ruskin, Natural Linen, Erik
Fabric group 2	Hallingdal, Clay, Barnum, Steelcut Trio, Fiord, Foss, Loop
Fabric group 3	Vidar, Divina Melange, Elle
Fabric group 4	Sisu, Safire
Fabric group 5	Gentle
Leather group 1	Omni
Leather group 2	Primo, Trace
Leather group 3	Max
Leather group 4	Nubuck, Vegeta, Organic, Cera

Delphi Elements – Overview

4501 End module 120x85 cm, Arm L or R

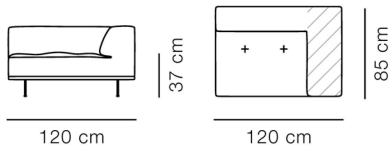
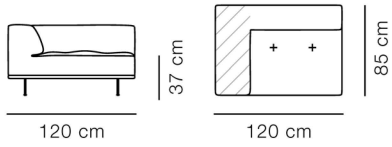

4514 End module 180x85 cm, Arm L or R

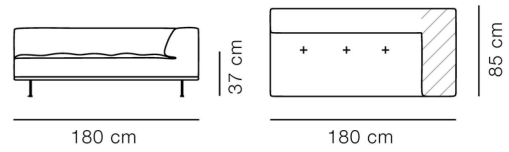
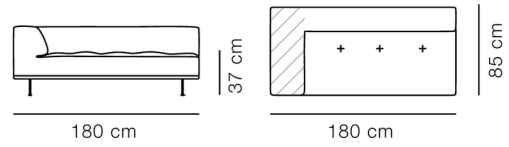

4502 Seat module 120x85 cm

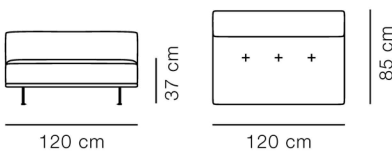

4506 Seat module 85x85 cm

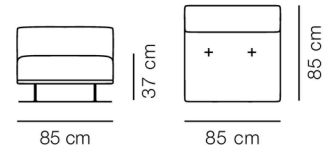

4503 Side chaise module 120x85 cm

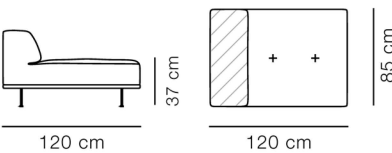

*Extended arm

4513 Corner module 85x85 cm

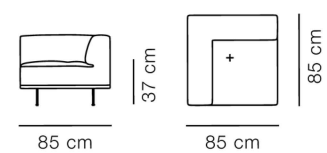

4504 Ottoman 120x85 cm

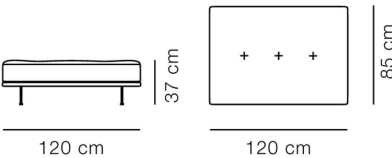

4505 Ottoman 85x85 cm

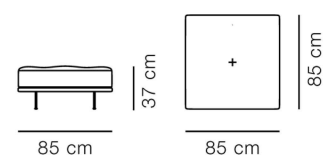

Delphi Elements – Configuration overview

Model 450A, Configuration A
 MODEL 4504 / 4501 (left) / 4506 / 4501 (right)

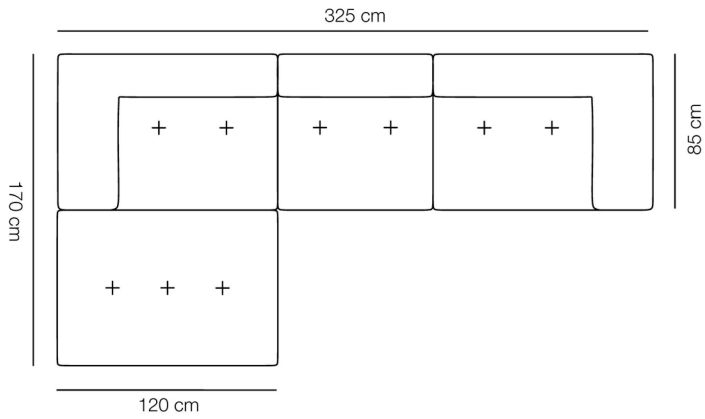

Model 450B, Configuration B
 MODEL 4501 (left) / 4513 / 4514 (right)

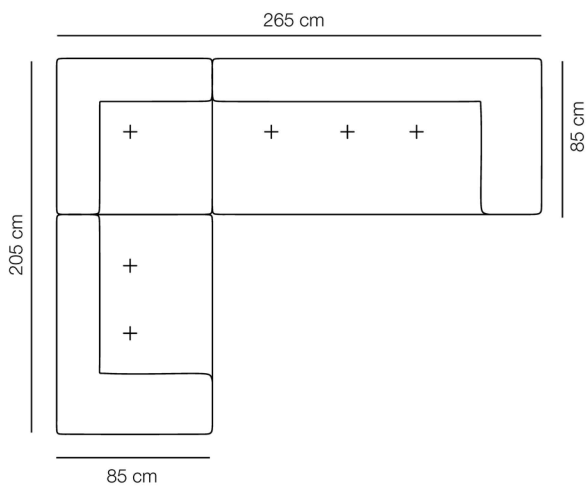

Model 450D, Configuration D
 MODEL 4514 (left) / 4513 / 4501 (right)

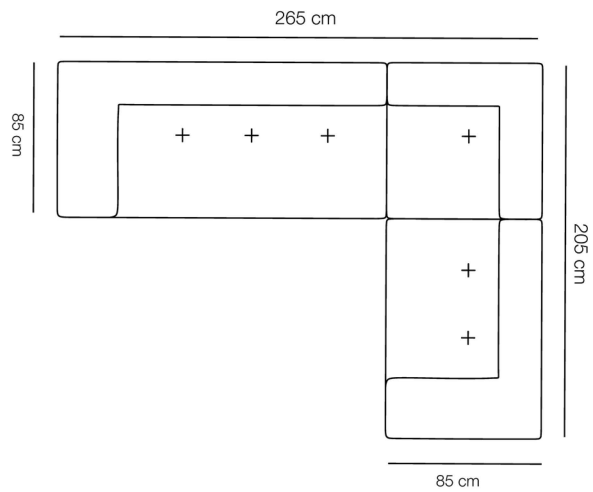

Model 450C, Configuration C
 MODEL 4503 / 4503 / 4501 (left) / 4502 / 4501 (right)

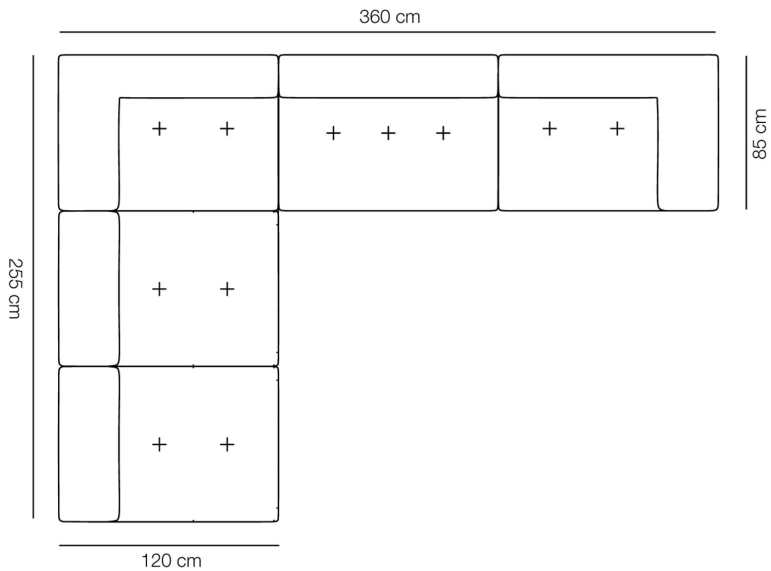

For customer's own configuration, please attach to the order a visual sketch of the desired layout

Model 2042

EJ220 Sofa 2 seater, 76 cm cushions



Designed by Erik Jørgensen, 1970

Sofa with separate arm, seat and back cushions. Inner frame of wood with nozag springs. Available in fabric or leather. Cushions available in foam core with down wrap. External cover available as non-removable. Cushion covers are removable. Legs in solid wood or steel.

Modeldetails

1 m³ Packaging dimensions:
49 kg / 42 kg L: 168 cm W: 95 cm H: 64 cm

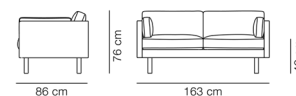

Essential Assortment

Item number	Upholstery	Legs	Price
20421930018021703110	Re-Wool 198	Oak soap treated, round legs	2.999
20421931118021703110	Re-Wool 128	Oak soap treated, round legs	2.999
20424064018021703110	Erik 3790 Linen	Oak soap treated, round legs	2.999
20424064218021703110	Erik 9998 Broken Grey	Oak soap treated, round legs	2.999
20425130118021704110	Leather Omni 301, Black	Brushed chrome, round legs	7.499
20425009518021704110	Leather Max 95, Cognac	Brushed chrome, round legs	8.333

Essential variants only delivered with HR foam

Order configuration

Cushion filling: Down cover.

Legs: Round wooden legs in either Oak soap, Oak lacquered or Smoked oak stain

Round steel legs in either Brushed chrome or Black powder coat.

Fabric group 1	3.288
Fabric group 2	3.855
Fabric group 3	4.128
Fabric group 4	4.946
Fabric group 5	5.935
C.O.M. fabric	3.288
Leather group 1	6.528
Leather group 2	7.526
Leather group 3	9.075
Leather group 4	9.844
Leather group 5	11.320
C.O.M. leather	6.528

Fabric consumption: 9,8 m. Leather consumption: 19,5 m²

Extra charge for

Removable cover (fabric only) add 1 m extra in Fabric consumption: +353

Recommended upholstery

Fabric group 1	Grand Linen, Remix, Capture, Bardal, Re-wool, Linara, Ruskin, Natural Linen, Erik
Fabric group 2	Hallingdal, Barnum, Loop, Steelcut Trio, Sunniva, Harald, Foss, Fiord, Clay, Savoy
Fabric group 3	Cotil, Divina Melange, Elle, Vidar
Fabric group 4	Grand Mohair, Sisu, Safire
Fabric group 5	Gentle
Leather group 1	Omni
Leather group 2	Primo, Trace
Leather group 3	Max
Leather group 4	Nubuck, Vegeta, Organic, Cera

Model 2052

EJ220 Sofa 2 seater, 86 cm cushions



Designed by Erik Jørgensen, 1970

Sofa with separate arm, seat and back cushions. Inner frame of wood with nozag springs. Available in fabric or leather. Cushions available in foam core with down wrap. External cover available as non-removable (standard) or removable. Cushion covers are removable. Legs in solid wood or steel.

Modeldetails

1,15 m³ Packaging dimensions:
54 kg / 47 kg L: 217 cm W: 95 cm H: 64 cm

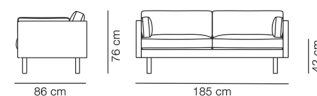

Essential Assortment

Item number	Upholstery	Legs	Price
20524064018021703110	Erik 3790 Linen	Oak soap treated, round legs	3.333
20524064218021703110	Erik 9998 Broken Grey	Oak soap treated, round legs	3.333
20521930018021703110	Re-Wool 198	Oak soap treated, round legs	3.749
20521931118021703110	Re-Wool 128	Oak soap treated, round legs	3.749
20525130118021704110	Leather Omni 301, Black	Brushed chrome, round legs	6.499
20525009518021704110	Leather Max 95, Cognac	Brushed chrome, round legs	9.166

Essential variants only delivered with HR foam

Order configuration

Cushion filling: Down cover.

Legs: Round wooden legs in either Oak soap, Oak lacquered or Smoked oak stain

Round steel legs in either Brushed chrome or Black powder coat.

Fabric group 1	3.645
Fabric group 2	4.272
Fabric group 3	4.574
Fabric group 4	5.479
Fabric group 5	6.575
C.O.M. fabric	3.645
Leather group 1	7.232
Leather group 2	8.336
Leather group 3	10.051
Leather group 4	10.902
Leather group 5	12.537
C.O.M. leather	7.232

Fabric consumption: 9,5 m. Leather consumption: 19,5 m²

Extra charge for

Removable cover (fabric only) add 1 m extra in Fabric consumption: +353

Recommended upholstery

Fabric group 1	Grand Linen, Remix, Capture, Bardal, Re-wool, Linara, Ruskin, Natural Linen, Erik
Fabric group 2	Hallingdal, Barnum, Loop, Steelcut Trio, Sunniva, Harald, Foss, Fiord, Clay, Savoy
Fabric group 3	Cotil, Divina Melange, Elle, Vidar
Fabric group 4	Grand Mohair, Sisu, Safire
Fabric group 5	Gentle
Leather group 1	Omni
Leather group 2	Primo, Trace
Leather group 3	Max
Leather group 4	Nubuck, Vegeta, Organic, Cera

Model 2062

EJ220 Sofa 2 seater, 100 cm cushions



Designed by Erik Jørgensen, 1970

Sofa with separate arm, seat and back cushions. Inner frame of wood with nozag springs. Available in fabric or leather. Cushions available in foam core with down wrap. External cover available as non-removable (standard) or removable. Cushion covers are removable. Legs in solid wood or steel.

Modeldetails

1,33 m³ Packaging dimensions:
63 kg / 57 kg L: 217 cm W: 95 cm H: 64 cm

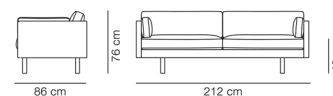

Essential Assortment

Item number	Upholstery	Legs	Price
20624064018021703110	Erik 3790 Linen	Oak soap treated, round legs	3.749
20624064218021703110	Erik 9998 Broken Grey	Oak soap treated, round legs	3.749
20621930018021703110	Re-Wool 198	Oak soap treated, round legs	3.999
20621931118021703110	Re-Wool 128	Oak soap treated, round legs	3.999
20625130118021704110	Leather Omni 301, Black	Brushed chrome, round legs	7.499
20625009518021704110	Leather Max 95, Cognac	Brushed chrome, round legs	9.999

Essential variants only delivered with HR foam

Order configuration

Cushion filling: Down cover.

Legs: Round wooden legs in either Oak soap, Oak lacquered or Smoked oak stain

Round steel legs in either Brushed chrome or Black powder coat.

Fabric group 1	4.170
Fabric group 2	4.890
Fabric group 3	5.237
Fabric group 4	6.276
Fabric group 5	7.531
C.O.M. fabric	4.170
Leather group 1	8.288
Leather group 2	9.554
Leather group 3	11.523
Leather group 4	12.500
Leather group 5	14.375
C.O.M. leather	8.288

Fabric consumption: 10,5 m. Leather consumption: 20 m²

Alternative leg placement is possible.

Extra charge for

Removable cover (fabric only) add 1 m extra in Fabric consumption: +353

Certifications

EN 1022:2005, EN 16139:2013 (L2)

Recommended upholstery

Fabric group 1	Grand Linen, Remix, Capture, Bardal, Re-wool, Linara, Ruskin, Natural Linen, Erik
Fabric group 2	Hallingdal, Barnum, Loop, Steelcut Trio, Sunniva, Harald, Foss, Fiord, Clay, Savoy
Fabric group 3	Cotil, Divina Melange, Elle, Vidar
Fabric group 4	Grand Mohair, Sisu, Safire
Fabric group 5	Gentle
Leather group 1	Omni
Leather group 2	Primo, Trace
Leather group 3	Max
Leather group 4	Nubuck, Vegeta, Organic, Cera

Model 2033

EJ220 Sofa 3 seater, 67 cm cushions



Designed by Erik Jørgensen, 1970

Sofa with separate arm, seat and back cushions. Inner frame of wood with nozag springs. Available in fabric or leather. Cushions available in foam core with down wrap. External cover available as non-removable (standard) or removable. Cushion covers are removable. interchangeable legs in solid wood or steel.

Modeldetails

1,32 m³ Packaging dimensions:
63 kg / 57 kg L: 217 cm W: 95 cm H: 64 cm

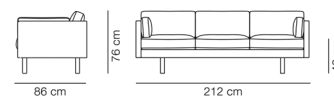

Essential Assortment

Item number	Upholstery	Legs	Price
20331930018021703110	Re-Wool 198	Oak soap treated, round legs	3.999
20331931118021703110	Re-Wool 128	Oak soap treated, round legs	3.999
20334064018021703110	Erik 3790 Linen	Oak soap treated, round legs	3.999
20334064218021703110	Erik 9998 Broken Grey	Oak soap treated, round legs	3.999
20335130118021704110	Leather Omni 301, Black	Brushed chrome, round legs	7.166
20335009518021704110	Leather Max 95, Cognac	Brushed chrome, round legs	9.833

Essential variants only delivered with HR foam

Order configuration

Cushion filling: Down cover.

Legs: Round wooden legs in either Oak soap, Oak lacquered or Smoked oak stain

Round steel legs in either Brushed chrome or Black powder coat.

Fabric group 1	4.132
Fabric group 2	4.845
Fabric group 3	5.189
Fabric group 4	6.218
Fabric group 5	7.462
C.O.M. fabric	4.132
Leather group 1	8.211
Leather group 2	9.466
Leather group 3	11.417
Leather group 4	12.384
Leather group 5	14.241
C.O.M. leather	8.211

Fabric consumption: 10,5 m. Leather consumption: 24 m²

Alternative leg placement is possible.

Extra charge for

Removable cover (fabric only) add 1 m extra in Fabric consumption: +353

Certifications

EN 1022:2005, EN 16139:2013 (L2)

Recommended upholstery

Fabric group 1	Grand Linen, Remix, Capture, Bardal, Re-wool, Linara, Ruskin, Natural Linen, Erik
Fabric group 2	Hallingdal, Barnum, Loop, Steelcut Trio, Sunniva, Harald, Foss, Fiord, Clay, Savoy
Fabric group 3	Cotil, Divina Melange, Elle, Vidar
Fabric group 4	Grand Mohair, Sisu, Safire
Fabric group 5	Gentle
Leather group 1	Omni
Leather group 2	Primo, Trace
Leather group 3	Max
Leather group 4	Nubuck, Vegeta, Organic, Cera

Model 8052

EJ280 Sofa 2 seater, 86 cm cushions



Designed by Erik Jørgensen Studio, 2010

Sofa with separate arm, seat and back cushions. Inner frame of wood with nozag springs. Available in fabric or leather. Cushions in foam core with down wrap. External cover available as non-removable (standard) or removable. Cushion covers are removable. Sledge legs in steel in two different heights, or legs in solid wood or aluminum. Available in two heights, please specify height.

Modeldetails

1,3 m³ Packaging dimensions:
63 kg / 57 kg L: 217 cm W: 95 cm H: 64 cm



Essential Assortment

Item number	Upholstery	Legs	Price
80521930017021711010	Re-Wool 198	Brushed chrome, sledge base (High)	3.749
80521931117021711010	Re-Wool 128	Brushed chrome, sledge base (High)	3.749
80524064017021711010	Erik 3790 Linen	Brushed chrome, sledge base (High)	3.749
80524064217021711010	Erik 9998 Broken Grey	Brushed chrome, sledge base (High)	3.749
80525130117021711010	Leather Omni 301, Black	Brushed chrome, sledge base (High)	7.499
80525009517021711010	Leather Max 95, Cognac	Brushed chrome, sledge base (High)	9.999

Essential variants only delivered with HR foam

Order configuration

Legs: Round wooden legs in either oak soap, oak lacquer or oak smoke stained.

Round steel legs in either brushed chrome or black powder coating.

Metal frame in brushed chrome.

Fabric group 1	4.103
Fabric group 2	4.779
Fabric group 3	5.105
Fabric group 4	6.080
Fabric group 5	7.296
C.O.M. fabric	4.103
Leather group 1	7.889
Leather group 2	9.087
Leather group 3	10.949
Leather group 4	11.872
Leather group 5	13.653
C.O.M. leather	7.889

Fabric consumption: 10,8 m. Leather consumption: 20 m²

Extra charge for

Removable cover (fabric only) add 1 m extra in Fabric consumption: +353

Recommended upholstery

Fabric group 1	Grand Linen, Remix, Capture, Bardal, Re-wool, Linara, Ruskin, Natural Linen, Erik
Fabric group 2	Hallingdal, Barnum, Loop, Steelcut Trio, Sunniva, Harald, Foss, Fiord, Clay, Savoy
Fabric group 3	Cotil, Divina Melange, Elle, Vidar
Fabric group 4	Grand Mohair, Sisu, Safire
Fabric group 5	Gentle
Leather group 1	Omni
Leather group 2	Primo
Leather group 3	Max
Leather group 4	Nubuck, Vegeta, Organic, Cera

Model 8062

EJ280 Sofa 2 seater, 100 cm cushions



Designed by Erik Jørgensen Studio, 2010

Sofa with separate arm, seat and back cushions. Inner frame of wood with nozag springs. Available in fabric or leather. Cushions in foam core with down wrap. External cover available as non-removable (standard) or removable. Cushion covers are removable. Sledge legs in steel in two different heights, or legs in solid wood or aluminum. Available in two heights, please specify height.

Modeldetails

1,49 m³ Packaging dimensions:
68 kg / L: 245 cm W: 95 cm H: 64 cm
62 kg

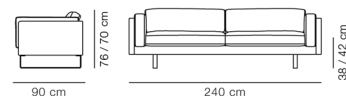

Essential Assortment

Item number	Upholstery	Legs	Price
80621930017021711010	Re-Wool 198	Brushed chrome, sledge base (High)	4.166
80621931117021711010	Re-Wool 128	Brushed chrome, sledge base (High)	4.166
80624064017021711010	Erik 3790 Linen	Brushed chrome, sledge base (High)	4.166
80624064217021711010	Erik 9998 Broken Grey	Brushed chrome, sledge base (High)	4.166
80625130117021711010	Leather Omni 301, Black	Brushed chrome, sledge base (High)	8.333
80625009517021711010	Leather Max 95, Cognac	Brushed chrome, sledge base (High)	10.833

Essential variants only delivered with HR foam

Order configuration

Legs: Round wooden legs in either oak soap, oak lacquer or oak smoke stained.

Round steel legs in either brushed chrome or black powder coating.

Metal frame in brushed chrome.

Fabric group 1	4.547
Fabric group 2	5.271
Fabric group 3	5.619
Fabric group 4	6.663
Fabric group 5	7.995
C.O.M. fabric	4.547
Leather group 1	8.797
Leather group 2	10.128
Leather group 3	12.197
Leather group 4	13.223
Leather group 5	15.206
C.O.M. leather	8.797

Fabric consumption: 11,5 m. Leather consumption: 23,5 m²

Extra charge for

Removable cover (fabric only) add 1 m extra in Fabric consumption: +353

Recommended upholstery

Fabric group 1	Erik, Grand Linen, Linara, Bardal, Capture, Remix, Natural Linen, Re-wool, Ruskin
Fabric group 2	Hallingdal, Harald, Savoy, Clay, Barnum, Sunniva, Steelcut Trio, Fiord, Foss, Loop
Fabric group 3	Vidar, Divina Melange, Elle, Cotil
Fabric group 4	Sisu, Grand Mohair, Safire
Fabric group 5	Gentle

Model 8072

EJ280 Sofa 2 seater, 120 cm cushions



Designed by Erik Jørgensen Studio, 2010

Sofa delivered in two modules with separate arm, seat and back cushions. Inner frame of wood with nozag springs. Available in fabric. Cushions in foam core with down wrap. External cover available as non-removable (standard) or removable. Cushion covers are removable. Sledge legs in steel in two different heights, or legs in solid wood or aluminum. Available in two heights, please specify height.

Modeldetails

1,7 m³ Packaging dimensions:
81 kg / 75 kg L: 285 cm W: 95 cm H: 64 cm

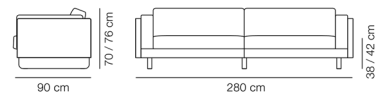

Essential Assortment

Item number	Upholstery	Legs	Price
807219300170217110A0	Re-Wool 198	Brushed chrome, sledge base (High)	5.833
807219311170217110A0	Re-Wool 128	Brushed chrome, sledge base (High)	5.833
807240640170217110A0	Erik 3790 Linen	Brushed chrome, sledge base (High)	5.833
807240642170217110A0	Erik 9998 Broken Grey	Brushed chrome, sledge base (High)	5.833

Essential variants only delivered with HR foam

Order configuration

Legs: Round wooden legs in either oak soap, oak lacquer or oak smoke stained.

Round steel legs in either brushed chrome or black powder coating.

Metal frame in brushed chrome.

Fabric group 1	6.178
Fabric group 2	6.836
Fabric group 3	7.494
Fabric group 4	8.767
Fabric group 5	10.124
C.O.M. fabric	6.178

Extra charge for

Removable cover (fabric only) add 1 m extra in Fabric consumption: +353

Certifications

FSC® certified

Recommended upholstery

Fabric group 1	Grand Linen, Linara, Bardal, Capture, Remix, Natural Linen, Re-wool, Ruskin, Erik
Fabric group 2	Hallingdal, Harald, Savoy, Clay, Barnum, Sunniva, Steelcut Trio, Fiord, Foss, Loop
Fabric group 3	Vidar, Divina Melange, Elle, Cotil
Fabric group 4	Sisu, Grand Mohair, Safire
Fabric group 5	Gentle

Model 809B

EJ280 Elements Configuration B, 290 x 290cm

Modeldetails

2,81 m³ Packaging dimensions:
159 kg / L: 96/96/96 cm W: 65/65/65 cm H:
144 kg 177/98/177 cm



Designed by Erik Jørgensen Studio, 2018

Available in fabric only. The external cover is non-removable. Sledge legs in steel in two different heights, or legs in solid wood or aluminum. Available in two heights, please specify height.

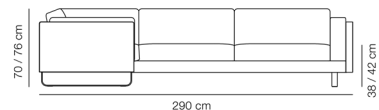

Order configuration

Legs: Round wooden legs in either oak soap, oak lacquer or oak smoke stained.

Round steel legs in either brushed chrome or black powder coating.

Metal frame in brushed chrome.

Fabric group 1	9.276
Fabric group 2	10.857
Fabric group 3	11.618
Fabric group 4	13.898
Fabric group 5	16.677
C.O.M. fabric	9.276

Fabric consumption: 20,3 m

Recommended upholstery

Fabric group 1	Grand Linen, Linara, Bardal, Capture, Remix, Natural Linen, Re-wool, Ruskin, Erik
Fabric group 2	Hallingdal, Harald, Savoy, Clay, Barnum, Sunniva, Steelcut Trio, Fiord, Foss, Loop
Fabric group 3	Vidar, Divina Melange, Elle, Cotil
Fabric group 4	Sisu, Grand Mohair, Safire
Fabric group 5	Gentle

Model 809C

EJ280 Elements Configuration C, 318 x 318cm

Designed by Erik Jørgensen Studio, 2018

Available in fabric only. The external cover is non-removable. Sledge legs in steel in two different heights, or legs in solid wood or aluminum. Available in two heights, please specify height.

Modeldetails

3,17 m³ Packaging dimensions:
183 kg / L: 96/96/96 cm W: 65/65/65 cm H:
166 kg 68/30/68 cm

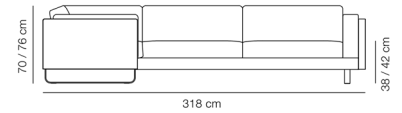

Order configuration

Legs: Round wooden legs in either oak soap, oak lacquer or oak smoke stained.

Round steel legs in either brushed chrome or black powder coating.

Metal frame in brushed chrome.

Fabric group 1	9.774
Fabric group 2	11.435
Fabric group 3	12.234
Fabric group 4	14.630
Fabric group 5	17.555
C.O.M. fabric	9.774

Fabric consumption: 21,9 m

Recommended upholstery

Fabric group 1	Grand Linen, Linara, Bardal, Capture, Remix, Natural Linen, Re-wool, Ruskin, Erik
Fabric group 2	Hallingdal, Harald, Savoy, Clay, Barnum, Sunniva, Steelcut Trio, Fiord, Foss, Loop
Fabric group 3	Vidar, Divina Melange, Elle, Cotil
Fabric group 4	Sisu, Grand Mohair, Safire
Fabric group 5	Gentle

Model 809D

EJ280 Elements Configuration D, 318cm x 218cm

Designed by Erik Jørgensen Studio, 2018

Available in fabric only. The external cover is non-removable. Sledge legs in steel in two different heights, or legs in solid wood or aluminum. Available in two heights, please specify height.

Modeldetails

2,55 m³ Packaging dimensions:
159 kg / L: 96/96/96 cm W: 65/65/65 cm H:
143 kg 105/98/205 cm

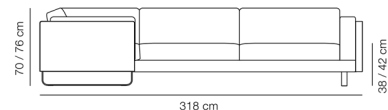

Order configuration

Legs: Round wooden legs in either oak soap, oak lacquer or oak smoke stained.

Round steel legs in either brushed chrome or black powder coating.

Metal frame in brushed chrome.

Fabric group 1	8.193
Fabric group 2	9.511
Fabric group 3	10.145
Fabric group 4	12.046
Fabric group 5	14.455
C.O.M. fabric	8.193

Fabric consumption: 18,5 m

Recommended upholstery

Fabric group 1	Grand Linen, Linara, Bardal, Capture, Remix, Natural Linen, Re-wool, Ruskin, Erik
Fabric group 2	Hallingdal, Harald, Savoy, Clay, Barnum, Sunniva, Steelcut Trio, Fiord, Foss, Loop
Fabric group 3	Vidar, Divina Melange, Elle, Cotil
Fabric group 4	Sisu, Grand Mohair, Safire
Fabric group 5	Gentle

Model 809E

EJ280 Elements Configuration E, 318 x 218cm

Designed by Erik Jørgensen Studio, 2018

Available in fabric only. The external cover is non-removable. Sledge legs in steel in two different heights, or legs in solid wood or aluminum. Available in two heights, please specify height.

Modeldetails

2,55 m³ Packaging dimensions:
159 kg / L: 96/96/96 cm W: 65/65/65 cm H:
143 kg 205/98/105 cm

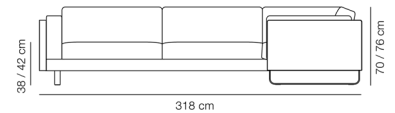

Order configuration

Legs: Round wooden legs in either oak soap, oak lacquer or oak smoke stained.

Round steel legs in either brushed chrome or black powder coating.

Metal frame in brushed chrome.

Fabric group 1	8.193
Fabric group 2	9.511
Fabric group 3	10.145
Fabric group 4	12.046
Fabric group 5	14.455
C.O.M. fabric	8.193

Fabric consumption: 18,5 m

Recommended upholstery

Fabric group 1	Grand Linen, Remix, Capture, Bardal, Re-wool, Linara, Ruskin, Natural Linen, Erik
Fabric group 2	Hallingdal, Barnum, Loop, Steelcut Trio, Sunniva, Harald, Foss, Fiord, Clay, Savoy
Fabric group 3	Cotil, Divina Melange, Elle, Vidar
Fabric group 4	Grand Mohair, Sisu, Safire
Fabric group 5	Gentle

Model 8099

EJ280 Elements Corner module



Designed by Erik Jørgensen Studio, 2018

Corner module for EJ280 Elements, including cushions. Available in fabric only. External cover is non-removable. Legs in solid wood or steel according to defined configuration. Modules cannot be rearranged after configuration. Available in two heights, please specify height.

Modeldetails

0,61 m³ Packaging dimensions:
35 kg / 30 kg L: 96 cm W: 65 cm H: 98 cm



Order configuration

Legs: Round wooden legs in either oak soap, oak lacquer or oak smoke stained.

Round steel legs in either brushed chrome or black powder coating.

Metal frame in brushed chrome.

Fabric group 1	1.686
Fabric group 2	2.001
Fabric group 3	2.152
Fabric group 4	2.606
Fabric group 5	3.127
C.O.M. fabric	1.686

Fabric consumption: 4,3 m

Recommended upholstery

Fabric group 1	Grand Linen, Remix, Capture, Bardal, Re-wool, Linara, Ruskin, Natural Linen, Erik
Fabric group 2	Hallingdal, Barnum, Loop, Steelcut Trio, Sunniva, Harald, Foss, Fiord, Clay, Savoy
Fabric group 3	Cotil, Divina Melange, Elle, Vidar
Fabric group 4	Grand Mohair, Sisu, Safire
Fabric group 5	Gentle

Model 8066

EJ280 Elements End module, 1 seater 100, Arm L or R



Designed by Erik Jørgensen Studio, 2018

End module for EJ280 Elements, including cushions and arm in one side. Available in fabric only. The external cover is non-removable. Sledge legs in steel, or legs in solid wood or aluminum. Please specify height and arm position left or right hand side, facing the sofa. Available in two heights, please specify height.

Modeldetails

0,66 m³ Packaging dimensions:
50 kg / 45 kg L: 96 cm W: 65 cm H: 105 cm

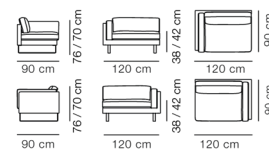

Order configuration

Legs: Round wooden legs in either oak soap, oak lacquer or oak smoke stained.

Round steel legs in either brushed chrome or black powder coating.

Metal frame in brushed chrome.

Fabric group 1	2.463
Fabric group 2	2.793
Fabric group 3	2.952
Fabric group 4	3.428
Fabric group 5	4.114
C.O.M. fabric	2.463

Fabric consumption: 5,4 m

Recommended upholstery

Fabric group 1	Grand Linen, Remix, Capture, Bardal, Re-wool, Linara, Ruskin, Natural Linen, Erik
Fabric group 2	Hallingdal, Barnum, Loop, Steelcut Trio, Sunniva, Harald, Foss, Fiord, Clay, Savoy
Fabric group 3	Cotil, Divina Melange, Elle, Vidar
Fabric group 4	Grand Mohair, Sisu, Safire
Fabric group 5	Gentle

Model 8057

EJ280 Elements End module, 2 seater 86, Arm L or R

Model details

1,1 m³ Packaging dimensions:
62 kg / 57 kg L: 96 cm W: 65 cm H: 177 cm



Designed by Erik Jørgensen Studio, 2018

End module for EJ280 Elements, including cushions and arm in one side. Available in fabric only. The external cover is non-removable. Please specify height and arm position left or right hand side, facing the sofa.

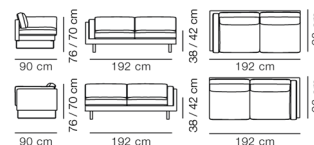

Order configuration

Legs: Round wooden legs in either oak soap, oak lacquer or oak smoke stained.

Round steel legs in either brushed chrome or black powder coating.

Metal frame in brushed chrome.

Fabric group 1	3.795
Fabric group 2	4.428
Fabric group 3	4.733
Fabric group 4	5.646
Fabric group 5	6.775
C.O.M. fabric	3.795

Fabric consumption: 8 m

Recommended upholstery

Fabric group 1	Grand Linen, Remix, Capture, Bardal, Re-wool, Linara, Ruskin, Natural Linen, Erik
Fabric group 2	Hallingdal, Barnum, Loop, Steelcut Trio, Sunniva, Harald, Foss, Fiord, Clay, Savoy
Fabric group 3	Cotil, Divina Melange, Elle, Vidar
Fabric group 4	Grand Mohair, Sisu, Safire
Fabric group 5	Gentle

Model 8067

EJ280 Elements End module, 2 seater 100, Arm L or R



Designed by Erik Jørgensen Studio, 2018

End module for EJ280 Elements, including cushions and arm in one side. Available in fabric only. The external cover is non-removable. Sledge legs in steel, or legs solid in wood or aluminum. Please specify height and arm position left or right hand side, facing the sofa.

Modeldetails

1,28 m³ Packaging dimensions:
68 kg / 62 kg L: 96 cm W: 65 cm H: 205 cm

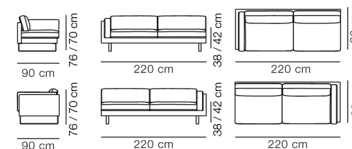

Order configuration

Legs: Round wooden legs in either oak soap, oak lacquer or oak smoke stained.

Round steel legs in either brushed chrome or black powder coating.

Metal frame in brushed chrome.

Fabric group 1	4.044
Fabric group 2	4.717
Fabric group 3	5.041
Fabric group 4	6.012
Fabric group 5	7.214
C.O.M. fabric	4.044

Fabric consumption: 8,8 m

Recommended upholstery

Fabric group 1	Grand Linen, Remix, Capture, Bardal, Re-wool, Linara, Ruskin, Natural Linen, Erik
Fabric group 2	Hallingdal, Barnum, Loop, Steelcut Trio, Sunniva, Harald, Foss, Fiord, Clay, Savoy
Fabric group 3	Cotil, Divina Melange, Elle, Vidar
Fabric group 4	Grand Mohair, Sisu, Safire
Fabric group 5	Gentle

EJ280 Elements - Overview

Model 809B, Configuration B
8057 L / 8099 / 8057 R

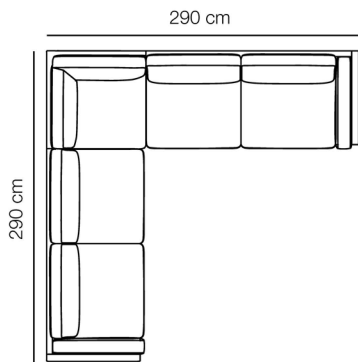

Model 809C, Configuration C
8067 L / 8099 / 8067 R

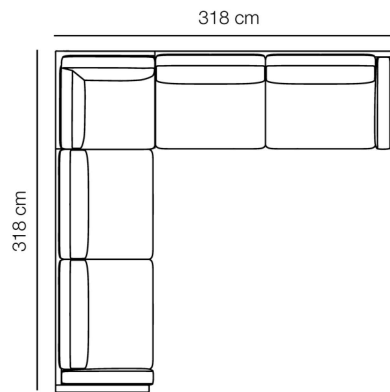

Model 809D, Configuration D
8066 L / 8099 / 8067 R

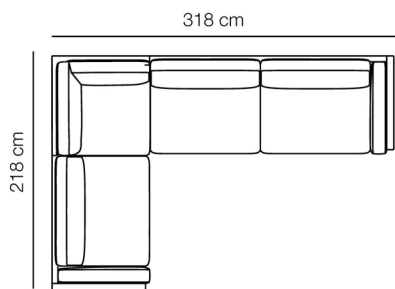

Model 809E, Configuration E
8067 L / 8099 / 8066 R

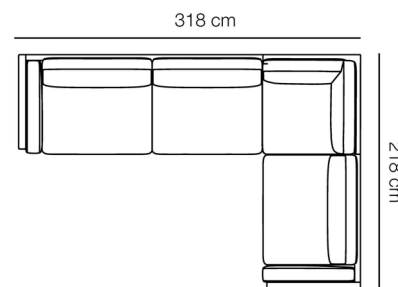

For customer's own configuration, please attach to the order a visual sketch of the desired layout

Model 2945

EJ295 Chaise Sofa 3 seater 76, Chaiselounge L or R

Modeldetails

2,1 m³ Packaging dimensions:
100 kg / 90 kg L: 96 / 96 cm W: 65 / 65 cm H: 160 / 170 cm



Designed by Erik Jørgensen Studio, 2018

Fully upholstered sofa with separate seat and back cushions. Inner frame of wood with nozag springs. Available in fabric only. Covers are removable on back cushions. External cover and seat cushion covers are non-removable. Cushions available in foam core with down wrap. Legs in aluminum. Please choose right or left hand chaise longue, facing the sofa.

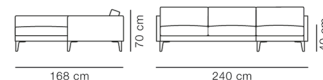

Essential Assortment

Item number	Upholstery	Legs	Version	Price
29451930017021509050	Re-Wool 198	Chrome	Right-facing	7.083
29451930017021509070	Re-Wool 198	Chrome	Left-facing	7.083
29451931117021509050	Re-Wool 128	Chrome	Right-facing	7.083
29451931117021509070	Re-Wool 128	Chrome	Left-facing	7.083
29454064017021509050	Erik 3790 Linen	Chrome	Right-facing	7.083
29454064017021509070	Erik 3790 Linen	Chrome	Left-facing	7.083
29454064217021509050	Erik 9998 Broken Grey	Chrome	Right-facing	7.083
29454064217021509070	Erik 9998 Broken Grey	Chrome	Left-facing	7.083

Essential variants only delivered with HR foam

Order configuration

Right or left facing.

	Chrome	Dark grey
Fabric group 1	7.162	7.162
Fabric group 2	8.417	8.417
Fabric group 3	9.021	9.021
Fabric group 4	10.831	10.831
Fabric group 5	12.997	12.997
C.O.M. fabric	7.162	7.162

Fabric consumption: 14 m

Incl. 3 side cushions.

Recommended upholstery

Fabric group 1	Grand Linen, Remix, Capture, Bardal, Re-wool, Linara, Ruskin, Erik, Natural Linen
Fabric group 2	Hallingdal, Barnum, Steelcut Trio, Sunniva, Harald, Foss, Fiord, Clay, Savoy, Loop
Fabric group 3	Divina Melange, Elle, Vidar
Fabric group 4	Sisu, Safire
Fabric group 5	Gentle

Model 2955

EJ295 Chaise Sofa 3 seater 86, Chaiselounge L or R

Modeldetails

2,3 m³ Packaging dimensions:
100 kg / 90 kg L: 96 / 96 cm W: 65 / 65 cm H: 170 / 190 cm



Designed by Erik Jørgensen Studio, 2016

Fully upholstered sofa with separate seat and back cushions. Inner frame of wood with nozag springs. Available in fabric only. Covers are removable on back cushions. External cover and seat cushion covers are non-removable. Cushions available in foam core with down wrap. Legs in aluminum. Please choose right or left hand chaise longue, facing the sofa.

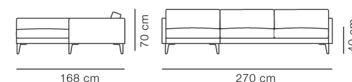

Essential Assortment

Item number	Upholstery	Legs	Version	Price
29551930017021509050	Re-Wool 198	Chrome	Right-facing	7.499
29551930017021509070	Re-Wool 198	Chrome	Left-facing	7.499
29551931117021509050	Re-Wool 128	Chrome	Right-facing	7.499
29551931117021509070	Re-Wool 128	Chrome	Left-facing	7.499
29554064017021509050	Erik 3790 Linen	Chrome	Right-facing	7.499
29554064017021509070	Erik 3790 Linen	Chrome	Left-facing	7.499
29554064217021509050	Erik 9998 Broken Grey	Chrome	Right-facing	7.499
29554064217021509070	Erik 9998 Broken Grey	Chrome	Left-facing	7.499

Essential variants only delivered with HR foam

Order configuration

Right or left facing.

	Chrome	Dark grey
Fabric group 1	7.513	7.513
Fabric group 2	8.839	8.839
Fabric group 3	9.478	9.478
Fabric group 4	11.391	11.391
Fabric group 5	13.670	13.670
C.O.M. fabric	7.513	7.513

Fabric consumption: 15 m

Incl. 3 side cushions.

Recommended upholstery

Fabric group 1	Grand Linen, Linara, Bardal, Capture, Remix, Re-wool, Ruskin, Natural Linen, Erik
Fabric group 2	Hallingdal, Harald, Savoy, Clay, Barnum, Sunniva, Steelcut Trio, Fiord, Foss, Loop
Fabric group 3	Vidar, Divina Melange, Elle
Fabric group 4	Sisu, Safire
Fabric group 5	Gentle

Model P2950

EJ295 Accessories Cushion

Designed by Erik Jørgensen Studio, 2018

Side cushion for EJ295 Sofa. Down/foam granulate. Removable cover.

Order configuration

Fabric group 1	275
Fabric group 2	358
Fabric group 3	398
Fabric group 4	517
Fabric group 5	620
C.O.M. fabric	275

Fabric consumption: 1,15 m

Cushion: 40 x 50 x 11 cm.

Recommended upholstery

Fabric group 1	Grand Linen, Linara, Bardal, Capture, Remix, Re-wool, Ruskin, Natural Linen, Erik
Fabric group 2	Hallingdal, Harald, Savoy, Clay, Barnum, Sunniva, Steelcut Trio, Fiord, Foss, Loop
Fabric group 3	Vidar, Divina Melange, Elle
Fabric group 4	Sisu, Safire
Fabric group 5	Gentle

Erik Jørgensen Sofa Collection – Base options

Material	Type	Available for
 <p>Brushed chrome</p>	  16,5 cm  12,5 cm	<p>EJ280 Sofa EJ280 Elements</p> <p>Base available in two heights</p>
  <p>Black Brushed chrome</p>	  18 cm	<p>EJ220 Sofa EJ280 Sofa EJ280 Elements</p>
   <p>Smoked oak stained Oak lacquered Oak soap</p>	  18 cm	<p>EJ220 Sofa EJ280 Sofa EJ280 Elements</p>
  <p>Dark grey Brushed chrome</p>	  15 cm	<p>EJ295 Chaise Sofa</p>

Model 1522

EJ315 Sofa 2 seater



Designed by Erik Ole Jørgensen, 1975

Fully upholstered sofa with separate seat, back and arm cushions. Inner frame of wood. Available in fabric or leather. Covers are non-removable. Solid foam cushions. Arm cushions with Velcro fixing. Solid wood base.

Model details

1,24 m³ Packaging dimensions:
55 kg / 45 kg L: 158 cm W: 97 cm H: 81 cm

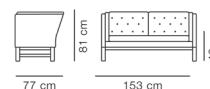

Essential Assortment

Item number	Upholstery	Legs	Price
15220020700003010300	Hallingdal 200	Oak soap treated	5.499
15220026800003010300	Hallingdal 116	Oak soap treated	5.499
15225130100003016400	Leather Omni 301, Black	Walnut oil treated	7.499
15225009500003010700	Leather Max 95, Cognac	Oak light oil	9.166

Essential variants only delivered with HR foam

Order configuration

	Oak soap	Oak oiled	Oak light oil	Oak black lacquered	Walnut oiled
Fabric group 1	5.436	5.642	5.436	5.436	5.708
Fabric group 2	5.833	6.039	5.833	5.833	6.105
Fabric group 3	6.024	6.231	6.024	6.024	6.296
Fabric group 4	6.597	6.803	6.597	6.597	6.869
Fabric group 5	7.916	8.123	7.916	7.916	8.243
C.O.M. fabric	5.436	5.642	5.436	5.436	5.708
Leather group 1	7.706	7.913	7.706	7.706	7.978
Leather group 2	8.405	8.611	8.405	8.405	8.677
Leather group 3	9.491	9.697	9.491	9.491	9.763
Leather group 4	10.029	10.235	10.029	10.029	10.301
Leather group 5	11.533	11.740	11.533	11.533	11.846
C.O.M. leather	7.706	7.913	7.706	7.706	7.978

Fabric consumption: 6,5 m. Leather consumption: 15,5 m²

Extra charge for

Buttons in leather for furniture with fabric: +103

Recommended upholstery

Fabric group 1	Grand Linen, Remix, Capture, Bardal, Re-wool, Linara, Ruskin, Natural Linen, Erik
Fabric group 2	Hallingdal, Barnum, Loop, Steelcut Trio, Sunniva, Harald, Foss, Fiord, Clay, Savoy
Fabric group 3	Cotil, Divina Melange, Elle, Vidar
Fabric group 4	Sisu, Safire
Fabric group 5	Gentle
Leather group 1	Omni
Leather group 2	Primo, Trace
Leather group 3	Max
Leather group 4	Nubuck, Vegeta, Organic, Cera

Model 1542

EJ315 Sofa 2½ seater



Designed by Erik Ole Jørgensen, 1975

Fully upholstered sofa with separate seat, back and arm cushions. Inner frame of wood. Available in fabric or leather. Covers are non-removable. Solid foam cushions. Arm cushions with Velcro fixing. Solid wood base.

Model details

1,3 m³ Packaging dimensions:
58 kg / 48 kg L: 185 cm W: 97 cm H: 81 cm

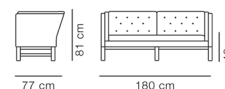

Essential Assortment

Item number	Upholstery	Legs	Price
15420020700003010300	Hallingdal 200	Oak soap treated	6.666
15420026800003010300	Hallingdal 116	Oak soap treated	6.666
15425130100003016400	Leather Omni 301, Black	Walnut oil treated	9.166
15425009500003010700	Leather Max 95, Cognac	Oak light oil	10.833

Essential variants only delivered with HR foam

Order configuration

	Oak soap	Oak oiled	Oak light oil	Oak black lacquered	Walnut oiled
Fabric group 1	6.202	6.409	6.202	6.202	6.474
Fabric group 2	6.676	6.882	6.676	6.676	6.948
Fabric group 3	6.904	7.110	6.904	6.904	7.176
Fabric group 4	7.587	7.793	7.587	7.587	7.859
Fabric group 5	9.104	9.311	9.104	9.104	9.431
C.O.M. fabric	6.202	6.409	6.202	6.202	6.474
Leather group 1	8.909	9.116	8.909	8.909	9.182
Leather group 2	9.742	9.949	9.742	9.742	10.015
Leather group 3	11.037	11.243	11.037	11.037	11.309
Leather group 4	11.679	11.885	11.679	11.679	11.951
Leather group 5	13.431	13.637	13.431	13.431	13.744
C.O.M. leather	8.909	9.116	8.909	8.909	9.182

Fabric consumption: 7,8 m. Leather consumption: 18,5 m²

Extra charge for

Buttons in leather for furniture with fabric: +103

Recommended upholstery

Fabric group 1	Grand Linen, Remix, Capture, Bardal, Re-wool, Linara, Ruskin, Natural Linen, Erik
Fabric group 2	Hallingdal, Barnum, Loop, Steelcut Trio, Sunniva, Harald, Foss, Fiord, Clay, Savoy
Fabric group 3	Cotil, Divina Melange, Elle, Vidar
Fabric group 4	Sisu, Safire
Fabric group 5	Gentle
Leather group 1	Omni
Leather group 2	Primo, Trace
Leather group 3	Max
Leather group 4	Nubuck, Vegeta, Organic, Cera

Model 1523

EJ315 Sofa 3 seater



Designed by Erik Ole Jørgensen, 1975

Fully upholstered sofa with separate seat, back and arm cushions. Inner frame of wood. Available in fabric or leather. Covers are non-removable. Solid foam cushions. Arm cushions with Velcro fixing. Solid wood base.

Model details

2,3 m³ Packaging dimensions:
68 kg / 58 kg L: 215 cm W: 97 cm H: 81 cm

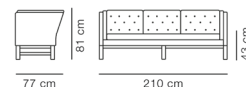

Essential Assortment

Item number	Upholstery	Legs	Price
15230020700003010300	Hallingdal 200	Oak soap treated	6.666
15230026800003010300	Hallingdal 116	Oak soap treated	6.666
15235130100003016400	Leather Omni 301, Black	Walnut oil treated	9.166
15235009500003010700	Leather Max 95, Cognac	Oak light oil	11.666

Essential variants only delivered with HR foam

Order configuration

	Oak soap	Oak oiled	Oak light oil	Oak black lacquered	Walnut oiled
Fabric group 1	6.679	6.885	6.679	6.679	6.951
Fabric group 2	7.199	7.405	7.199	7.199	7.471
Fabric group 3	7.449	7.655	7.449	7.449	7.721
Fabric group 4	8.198	8.404	8.198	8.198	8.470
Fabric group 5	9.837	10.044	9.837	9.837	10.164
C.O.M. fabric	6.679	6.885	6.679	6.679	6.951
Leather group 1	9.648	9.855	9.648	9.648	9.921
Leather group 2	10.562	10.768	10.562	10.562	10.834
Leather group 3	11.982	12.188	11.982	11.982	12.254
Leather group 4	12.686	12.892	12.686	12.686	12.958
Leather group 5	14.589	14.795	14.589	14.589	14.902
C.O.M. leather	9.648	9.855	9.648	9.648	9.921

Fabric consumption: 8,5 m. Leather consumption: 19,9 m²

Extra charge for

Buttons in leather for furniture with fabric: +103

Recommended upholstery

Fabric group 1	Grand Linen, Remix, Capture, Bardal, Re-wool, Linara, Ruskin, Natural Linen, Erik
Fabric group 2	Hallingdal, Barnum, Loop, Steelcut Trio, Sunniva, Harald, Foss, Fiord, Clay, Savoy
Fabric group 3	Cotil, Divina Melange, Elle, Vidar
Fabric group 4	Sisu, Safire
Fabric group 5	Gentle
Leather group 1	Omni
Leather group 2	Primo, Trace
Leather group 3	Max
Leather group 4	Nubuck, Vegeta, Organic, Cera

Model 5722

Gomo Sofa 2-pers.



Designed by Hugo Passos, 2023

Fully upholstered sofa. Inner construction consists of a wooden shell in moulded plywood and furniture board and seat supported with webbing. Upholstered in HR or CMHR foam and cover in fabric or leather. Fabric cover is removable. Fixed base where chair is mounted with plastic legs with reversible glides in plastic which can be changed to felt.

Modeldetails

0,88 m³ Packaging dimensions:
44 kg / 40 kg L: 151 cm W: 76 cm H: 77 cm

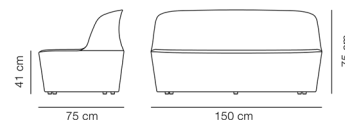

Essential Assortment

Item number	Upholstery	Price
5722193000005503271	Re-Wool 198	2.724
57221931100005503271	Re-Wool 128	2.724

Essential variants are delivered with plastic glides and HR foam

Order configuration

Fabric group 0	2.491
Fabric group 1	2.801
Fabric group 2	3.025
Fabric group 3	3.240
Fabric group 4	3.629
Fabric group 5	4.337
C.O.M. fabric	2.801
Leather group 0	3.872
Leather group 1	4.422
Leather group 2	4.944
Leather group 3	5.624
Leather group 4	6.761
Leather group 5	8.733
C.O.M. leather	4.422
Sheepskin	5.631

Fabric consumption: 3,6 m. Leather consumption: 10,9 m²

When upholstered in velvet the stitching will not be visible.

Certifications

FSC® certified

EU Ecolabel variants: HR foam and upholstery in Connect, Remix, Re-wool, Steelcut Quartet, Vidar, Tonus or Wave fabric

ANSI/BIFMA X5.4-2020

Recommended upholstery

Fabric group 0	Connect
Fabric group 1	Grand Linen, Capture, Re-wool, Bardal, Ruskin, Linara, Remix, Erik
Fabric group 2	Hallingdal, Foss, Sunniva, Barnum, Steelcut Trio, Fiord, Clay, Loop
Fabric group 3	Divina Melange, Vidar, Cotil, Elle
Fabric group 4	Safire, Sisu
Fabric group 5	Gentle
Leather group 0	Vice
Leather group 1	Omni
Leather group 2	Primo, Trace
Leather group 3	Max
Leather group 4	Vegeta, Nubuck, Organic

Model P5722

Gomo Accessories Cover for Gomo sofa

Designed by Hugo Passos, 2023

Loose cover for re-upholstery of Gomo Sofa. Please note there will not be visible stitching in velour textiles.
Professional assistance is recommended.

Order configuration

Fabric group 0	747
Fabric group 1	840
Fabric group 2	906
Fabric group 3	970
Fabric group 4	1.088
Fabric group 5	1.300
C.O.M. fabric	840

Fabric consumption: 3,6 m

Recommended upholstery

Fabric group 0	Connect
Fabric group 1	Grand Linen, Capture, Re-wool, Bardal, Ruskin, Linara, Remix, Erik
Fabric group 2	Hallingdal, Foss, Sunniva, Barnum, Steelcut Trio, Fiord, Clay, Loop
Fabric group 3	Divina Melange, Vidar, Cotil, Elle
Fabric group 4	Safire, Sisu
Fabric group 5	Gentle

Model 1632

Haiku Sofa 2 seater



Designed by GamFratesi, 2012

Fully upholstered sofa with separate seat cushion. Inner frame of high pressure polyurethane foam, reinforced with a steel frame. Removable seat cushion in HR or CMHR-foam. Seat cushion has removable cover. The rear side of the sofa is available in fabric or leather. The front side is available in fabric only. Legs of powder coated steel. Two decorative back cushions included.

Modeldetails

2 m³ Packaging dimensions:
153 kg / 56 kg L: 97 cm W: 165 cm H: 125 cm

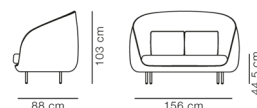

Order configuration

Frame: Black.

	Front side: Fabric group 1	Front side: Fabric group 2	Front side: Fabric group 3	Front side: Fabric group 4	Front side: Fabric group 5	Front side: C.O.M. fabric
Fabric group 1	5.779	6.172	6.667	7.286	8.323	5.284
Fabric group 2	6.042	6.434	6.930	7.549	8.585	5.547
Fabric group 3	6.374	6.766	7.262	7.881	8.865	5.879
Fabric group 4	6.789	7.182	7.677	8.296	9.333	6.294
Fabric group 5	7.484	7.877	8.372	8.991	10.028	6.989
C.O.M. fabric	5.779	6.172	6.667	7.286	8.323	5.284
Leather group 1	6.373	6.765	7.261	7.880	8.916	5.878
Leather group 2	7.010	7.403	7.898	8.517	9.554	6.515
Leather group 3	7.884	8.276	8.772	9.391	10.427	7.388
Leather group 4	8.672	9.104	9.649	10.330	11.470	8.127
Leather group 5	9.973	10.469	11.096	11.879	13.191	9.346
C.O.M. leather	6.373	6.765	7.261	7.880	8.916	5.878

Incl. 2 cushions in the same upholstery as front side.

Front side upholstery: Fabric only.

Fabric consumption front: 3,87 m, fabric consumption back: 3,79 m, leather consumption back: 8,04 m².

Certifications

EN 15373:2007 (L2)

Recommended upholstery

Fabric group 1	Capture, Re-wool, Remix, Bardal, Linara, Ruskin, Natural Linen, Erik
Fabric group 2	Hallingdal, Sunniva, Barnum, Fiord, Steelcut Trio, Harald, Foss, Loop, Clay
Fabric group 3	Vidar, Divina Melange, Elle
Fabric group 4	Grand Mohair, Safire, Sisu
Fabric group 5	Gentle
Leather group 0	Vice
Leather group 1	Omni
Leather group 2	Primo, Trace
Leather group 3	Max
Leather group 4	Nubuck, Vegeta, Organic, Cera

Model 1633

Haiku Sofa 3 seater



Designed by GamFratesi, 2012

Fully upholstered sofa with separate seat cushion. Inner frame of high pressure polyurethane foam, reinforced with a steel frame. Removable seat cushion in HR or CMHR-foam. Seat cushion has removable cover. The rear side of the sofa is available in fabric or leather. The front side is available in fabric only. Legs of powder coated steel. Three decorative back cushions included.

Modeldetails

2,9 m³ Packaging dimensions:
199 kg / 81 kg L: 97 cm W: 238 cm H: 125 cm

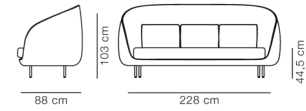

Order configuration

Frame: Black.

	Front side: Fabric group 1	Front side: Fabric group 2	Front side: Fabric group 3	Front side: Fabric group 4	Front side: Fabric group 5	Front side: C.O.M. fabric
Fabric group 1	7.166	7.734	8.456	9.359	10.857	6.451
Fabric group 2	7.500	8.068	8.790	9.693	11.191	6.785
Fabric group 3	7.928	8.496	9.218	10.121	11.619	7.213
Fabric group 4	8.452	9.020	9.742	10.645	12.143	7.737
Fabric group 5	9.295	9.863	10.585	11.488	12.986	8.580
C.O.M. fabric	7.166	7.734	8.456	9.359	10.857	6.451
Leather group 1	7.983	8.551	9.273	10.176	11.674	7.268
Leather group 2	8.870	9.437	10.159	11.063	12.560	8.154
Leather group 3	9.698	10.265	10.987	11.891	13.388	8.982
Leather group 4	10.667	11.292	12.086	13.080	14.727	9.881
Leather group 5	12.267	12.986	13.899	15.042	16.936	11.363
C.O.M. leather	7.983	8.551	9.273	10.176	11.674	7.268

Incl. 3 cushions in the same upholstery as front side.

Front side upholstery: Fabric only.

Fabric consumption front: 5,69 m, fabric consumption back: 4,42 m, leather consumption back: 10,5 m².

Certifications

EN 15373:2007 (L2)

Recommended upholstery

Fabric group 1	Capture, Re-wool, Remix, Bardal, Linara, Ruskin, Natural Linen, Erik
Fabric group 2	Hallingdal, Sunniva, Barnum, Fiord, Steelcut Trio, Harald, Foss, Loop, Clay
Fabric group 3	Vidar, Divina Melange, Elle
Fabric group 4	Grand Mohair, Safire, Sisu
Fabric group 5	Gentle
Leather group 0	Vice
Leather group 1	Omni
Leather group 2	Primo, Trace
Leather group 3	Max
Leather group 4	Nubuck, Vegeta, Organic, Cera

Model 6522

JG Sofa 2 seater



Designed by Jørgen Gammelgaard, 1979

Fully upholstered sofa with piping on cushions. Separate seat and back cushions. Inner frame of wood. Available in fabric or leather. Cushions in foam core with down wrap and removable covers. External frame cover is non-removable. Legs of solid wood or steel screwed into the frame. Oak legs available with natural leather band and brushed steel available with a knurled detail.

Modeldetails

0,86 m³ Packaging dimensions:
57 kg / 50 kg L: 82 cm W: 73 cm H: 144 cm

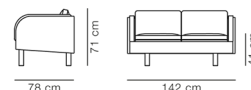

Essential Assortment

Item number	Upholstery	Legs	Price
652219311010700	Re-Wool 128	Oak light oil	3.999
652244807016400	Grand Linen Naturel 0024	Walnut oil treated	3.999
652251301060100	Leather Omni 301, Black	Stainless steel, brushed	5.999
652250090011700	Leather Vegeta 90, Natural	Oak light oil / natural leather strap	8.999

Essential variants only delivered with HR foam

Order configuration

	Oak light oil	Oak light oil with natural leather strap	Walnut oil	Brushed stainless steel	Brushed steel, Knurled
Fabric group 0	4.113	4.113	4.113	4.113	4.113
Fabric group 1	4.414	4.414	4.414	4.414	4.414
Fabric group 2	5.017	5.017	5.017	5.017	5.017
Fabric group 3	5.618	5.618	5.618	5.618	5.618
Fabric group 4	6.612	6.612	6.612	6.612	6.612
Fabric group 5	8.027	8.027	8.027	8.027	8.027
C.O.M. fabric	4.414	4.414	4.414	4.414	4.414
Leather group 0	5.344	5.344	5.344	5.344	5.344
Leather group 1	6.157	6.157	6.157	6.157	6.157
Leather group 2	7.240	7.240	7.240	7.240	7.240
Leather group 3	8.324	8.324	8.324	8.324	8.324
Leather group 4	9.408	9.408	9.408	9.408	9.408
Leather group 5	11.575	11.575	11.575	11.575	11.575
C.O.M. leather	6.157	6.157	6.157	6.157	6.157

Fabric consumption: 8,5 m. Leather consumption: 17 m²

Recommended upholstery

Fabric group 0	Connect
Fabric group 1	Grand Linen, Capture, Bardal, Re-wool, Linara, Ruskin, Natural Linen, Erik
Fabric group 2	Hallingdal, Barnum, Loop, Steelcut Trio, Sunniva, Harald, Foss, Fiord, Clay
Fabric group 3	Cotil, Divina Melange, Elle, Vidar
Fabric group 4	Sisu, Safire
Fabric group 5	Gentle
Leather group 0	Vice
Leather group 1	Omni
Leather group 2	Primo, Trace
Leather group 3	Max
Leather group 4	Nubuck, Vegeta, Organic

Model 6523

JG Sofa 3 seater



Designed by Jørgen Gammelgaard, 1979

Fully upholstered sofa with piping on cushions. Separate seat and back cushions. Inner frame of wood. Available in fabric or leather. Cushions in foam core with down wrap and removable covers. External frame cover is non-removable. Legs of solid wood or steel screwed into the frame. Oak legs available with natural leather band and brushed steel available with a knurled detail.

Modeldetails

1,22 m³ Packaging dimensions:
77 kg / 70 kg L: 82 cm W: 73 cm H: 204 cm

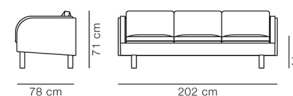

Essential Assortment

Item number	Upholstery	Legs	Price
652319311010700	Re-Wool 128	Oak light oil	4.499
652344807016400	Grand Linen Naturel 0024	Walnut oil treated	4.499
652351301060100	Leather Omni 301, Black	Stainless steel, brushed	6.499
652350090011700	Leather Vegeta 90, Natural	Oak light oil / natural leather strap	8.999

Essential variants only delivered with HR foam

Order configuration

	Oak light oil	Oak light oil with natural leather strap	Walnut oil	Brushed stainless steel	Brushed steel, Knurled
Fabric group 0	4.747	4.747	4.747	4.747	4.747
Fabric group 1	5.048	5.048	5.048	5.048	5.048
Fabric group 2	5.650	5.650	5.650	5.650	5.650
Fabric group 3	6.252	6.252	6.252	6.252	6.252
Fabric group 4	7.245	7.245	7.245	7.245	7.245
Fabric group 5	8.660	8.660	8.660	8.660	8.660
C.O.M. fabric	5.048	5.048	5.048	5.048	5.048
Leather group 0	5.978	5.978	5.978	5.978	5.978
Leather group 1	6.790	6.790	6.790	6.790	6.790
Leather group 2	7.874	7.874	7.874	7.874	7.874
Leather group 3	8.958	8.958	8.958	8.958	8.958
Leather group 4	10.042	10.042	10.042	10.042	10.042
Leather group 5	12.209	12.209	12.209	12.209	12.209
C.O.M. leather	6.790	6.790	6.790	6.790	6.790

Fabric consumption: 10 m. Leather consumption: 20 m²

Recommended upholstery

Fabric group 0	Connect
Fabric group 1	Grand Linen, Capture, Bardal, Re-wool, Linara, Ruskin, Natural Linen, Erik
Fabric group 2	Hallingdal, Barnum, Loop, Steelcut Trio, Sunniva, Harald, Foss, Fiord, Clay
Fabric group 3	Cotil, Divina Melange, Elle, Vidar
Fabric group 4	Sisu, Safire
Fabric group 5	Gentle
Leather group 0	Vice
Leather group 1	Omni
Leather group 2	Primo, Trace
Leather group 3	Max
Leather group 4	Nubuck, Vegeta, Organic

Model 4952

Konami Sofa 2 seater



Designed by Damian Williamson, 2019

Fully upholstered sofa. Inner frame of wood with cold cured foam. Cushions are fixed to the body of the sofa. Available in a limited selection of fabrics only. All covers are non-removable. Powder coated steel or brushed stainless steel base.

Modeldetails

3,1 m³ Packaging dimensions:
185 kg / 71,4 kg L: 287 cm W: 112 cm H: 96 cm

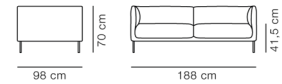

Essential Assortment

Item number	Upholstery	Legs	Price
49520167014098400000	Loop 36	Black	6.583
49520167214098601000	Loop 32	Stainless steel, brushed	6.583
49520167314098400000	Loop 42	Black	6.583
49524070714098400000	Sisu 0105	Black	7.083
49524070814098601000	Sisu 0125	Stainless steel, brushed	7.083

Essential variants only delivered with HR foam

Order configuration

	Black	Brushed stainless steel
Fabric group 1	6.187	6.187
Fabric group 2	6.747	6.747
Fabric group 3	7.017	7.017
Fabric group 4	7.824	7.824
Fabric group 5	9.389	9.389
C.O.M. fabric	6.187	6.187

Fabric consumption: 7,5 m

Only available in selected fabrics.

Note - Complementary cushions are ordered separately (P4900).

Recommended upholstery

Fabric group 1	Bardal, Re-wool
Fabric group 2	Hallingdal, Clay, Barnum, Loop
Fabric group 3	Vidar, Divina Melange, Elle
Fabric group 4	Sisu, Safire
Fabric group 5	Gentle

Model 4962

Konami Sofa 2 seater



Designed by Damian Williamson, 2019

Fully upholstered sofa. Inner frame of wood with cold cured foam. Cushions are fixed to the body of the sofa. Available in a limited selection of fabrics only. All covers are non-removable. Powder coated steel or brushed stainless steel base.

Modeldetails

3,1 m³ Packaging dimensions:
194 kg / 90 kg L: 287 cm W: 112 cm H: 96 cm

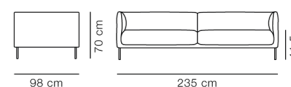

Essential Assortment

Item number	Upholstery	Legs	Price
49620167014098400000	Loop 36	Black	7.083
49620167214098601000	Loop 32	Stainless steel, brushed	7.083
49620167314098400000	Loop 42	Black	7.083
49624070714098400000	Sisu 0105	Black	8.333
49624070814098601000	Sisu 0125	Stainless steel, brushed	8.333

Essential variants only delivered with HR foam

Order configuration

	Black	Brushed stainless steel
Fabric group 1	6.872	6.872
Fabric group 2	7.507	7.507
Fabric group 3	7.813	7.813
Fabric group 4	8.728	8.728
Fabric group 5	10.473	10.473
C.O.M. fabric	6.872	6.872

Fabric consumption: 7,5 m

Only available in selected fabrics.

Note - Complementary cushions are ordered separately (P4900).

Recommended upholstery

Fabric group 1	Bardal, Re-wool
Fabric group 2	Hallingdal, Clay, Barnum, Loop
Fabric group 3	Vidar, Divina Melange, Elle
Fabric group 4	Sisu, Safire
Fabric group 5	Gentle

Model 4953

Konami Sofa 2 seater



Designed by Damian Williamson, 2019

Fully upholstered sofa. Inner frame of wood with cold cured foam. Cushions are fixed to the body of the sofa. Available in a limited selection of fabrics only. All covers are non-removable. Powder coated steel or brushed stainless steel base.

Modeldetails

3,1 m³ Packaging dimensions:
214 kg / 110 kg L: 287 cm W: 112 cm H: 96 cm

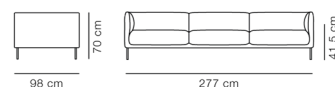

Essential Assortment

Item number	Upholstery	Legs	Price
49530167014098400000	Loop 36	Black	7.874
49530167214098601000	Loop 32	Stainless steel, brushed	7.874
49530167314098400000	Loop 42	Black	7.874
49534070714098400000	Sisu 0105	Black	9.541
49534070814098601000	Sisu 0125	Stainless steel, brushed	9.541

Essential variants only delivered with HR foam

Order configuration

	Black	Brushed stainless steel
Fabric group 1	8.067	8.067
Fabric group 2	8.777	8.777
Fabric group 3	9.118	9.118
Fabric group 4	10.141	10.141
Fabric group 5	12.169	12.169
C.O.M. fabric	8.067	8.067

Fabric consumption: 9,5 m

Only available in selected fabrics.

Note - Complementary cushions are ordered separately (P4900).

Recommended upholstery

Fabric group 1	Bardal, Re-wool
Fabric group 2	Hallingdal, Clay, Barnum, Loop
Fabric group 3	Vidar, Divina Melange, Elle
Fabric group 4	Sisu, Safire
Fabric group 5	Gentle

Model P4900



Konami / Nami Accessories PKiollonawm ci uCsuhsiohnion,

Designed by Damian Williamson, 2019

Decorative cushion for Konami Sofa. Down filling. Removable cover in fabric.

Order configuration

Fabric group 1	310
Fabric group 2	350
Fabric group 3	380
Fabric group 4	425
Fabric group 5	530
C.O.M. fabric	310

Fabric consumption: 0,55 m

Cushion: 50 x 50 cm.

Recommended upholstery

Fabric group 1	Bardal, Re-wool
Fabric group 2	Hallingdal, Clay, Barnum, Loop
Fabric group 3	Vidar, Divina Melange, Elle
Fabric group 4	Sisu, Safire
Fabric group 5	Gentle

Model 2208

Mogensen 2208 Sofa 2 seater



Designed by Børge Mogensen, 1963

Fully upholstered sofa with piping in all stitches. Available in leather or fabric. Fixed legs of solid wood, built into the wood internal frame. Seat is supported with jute and rubber band webbing. Separate seat and back cushions with removable covers. Please specify cushion type. Cushions are either with foam core with down wrap or filled with a foam and down mix in separate chambers

Modeldetails

1,94 m³ Packaging dimensions:
103 kg / 37 kg L: 192 cm W: 97 cm H: 104 cm

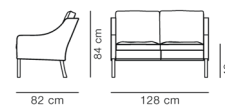

Order configuration

	Oak soap	Oak oiled	Oak light oil	Oak black lacquered	Walnut oiled
Fabric group 1	7.665	7.665	7.665	7.665	7.665
Fabric group 2	8.105	8.105	8.105	8.105	8.105
Fabric group 3	8.546	8.546	8.546	8.546	8.546
Fabric group 4	9.364	9.364	9.364	9.364	9.364
Fabric group 5	10.310	10.310	10.310	10.310	10.310
Leather group 1	8.752	8.752	8.752	8.752	8.752
Leather group 2	9.151	9.151	9.151	9.151	9.151
Leather group 3	10.062	10.062	10.062	10.062	10.062
Leather group 4	11.068	11.068	11.068	11.068	11.068
Leather group 5	12.729	12.729	12.729	12.729	12.729

Fabric consumption: 7,65 m. Leather consumption: 12,77 m²

Recommended upholstery

Fabric group 1	Bardal, Ruskin, Linara, Capture, Remix, Re-wool, Grand Linen, Erik
Fabric group 2	Hallingdal, Sunniva, Fiord, Savoy, Clay, Barnum, Steelcut Trio, Foss, Loop
Fabric group 3	Divina Melange, Vidar
Fabric group 4	Sisu, Safire
Fabric group 5	Gentle
Leather group 1	Omni
Leather group 2	Primo, Trace
Leather group 3	Max
Leather group 4	Vegeta, Nubuck, Organic, Cera

Model 2209

Mogensen 2209 Sofa 3 seater



Designed by Børge Mogensen, 1963

Fully upholstered sofa with piping in all stitches. Available in leather or fabric. Fixed legs of solid wood, built into the wood internal frame. Seat is supported with jute and rubber band webbing. Separate seat and back cushions with removable covers. Please specify cushion type. Cushions are either with foam core with down wrap or filled with a foam and down mix in separate chambers

Modeldetails

2,4 m³ Packaging dimensions:
129 kg / 45 kg L: 245 cm W: 96 cm H: 102 cm

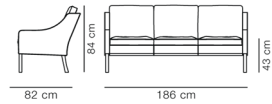

Order configuration

	Oak soap	Oak oiled	Oak light oil	Oak black lacquered	Walnut oiled
Fabric group 1	9.840	9.840	9.840	9.840	9.840
Fabric group 2	10.434	10.434	10.434	10.434	10.434
Fabric group 3	11.029	11.029	11.029	11.029	11.029
Fabric group 4	12.132	12.132	12.132	12.132	12.132
Fabric group 5	13.408	13.408	13.408	13.408	13.408
Leather group 1	11.232	11.232	11.232	11.232	11.232
Leather group 2	11.770	11.770	11.770	11.770	11.770
Leather group 3	12.923	12.923	12.923	12.923	12.923
Leather group 4	14.215	14.215	14.215	14.215	14.215
Leather group 5	16.347	16.347	16.347	16.347	16.347

Fabric consumption: 10 m. Leather consumption: 16,26 m²

Recommended upholstery

Fabric group 1	Bardal, Ruskin, Linara, Capture, Remix, Re-wool, Grand Linen, Erik
Fabric group 2	Hallingdal, Sunniva, Fiord, Savoy, Clay, Barnum, Steelcut Trio, Foss, Loop
Fabric group 3	Divina Melange, Vidar
Fabric group 4	Sisu, Safire
Fabric group 5	Gentle
Leather group 1	Omni
Leather group 2	Primo, Trace
Leather group 3	Max
Leather group 4	Vegeta, Nubuck, Organic, Cera

Model 2212

Mogensen 2212 Sofa 2 seater



Designed by Børge Mogensen, 1962

Fully upholstered sofa with piping in all stitches. Available in leather or fabric. Fixed legs of solid wood, built into the wood internal frame. Seat is supported with jute and rubber band webbing. Separate seat, back and arm cushions with removable covers. Please specify cushion type. Cushions are either with foam core with down wrap or filled with a foam and down mix in separate chambers

Modeldetails

1,94 m³ Packaging dimensions:
119 kg / 53 kg L: 192 cm W: 97 cm H: 104 cm

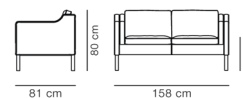

Essential Assortment

Item number	Upholstery	Wood	Price
22121645008810	Leather Primo 88, Black	Walnut oiled	9.999
22121035009010	Leather Vegeta 90, Natural	Oak soap	11.666
22121055090610	Leather Organic 906, Mocca	Oak oil	11.666
22121075084110	Leather Cera 905, Russet brown	Oak light oil	11.666

Essential variants only delivered with HR foam

Order configuration

	Oak soap	Oak oiled	Oak light oil	Oak black lacquered	Walnut oiled
Fabric group 1	9.186	9.186	9.186	9.186	9.186
Fabric group 2	9.938	9.938	9.938	9.938	9.938
Fabric group 3	10.691	10.691	10.691	10.691	10.691
Fabric group 4	12.088	12.088	12.088	12.088	12.088
Fabric group 5	13.703	13.703	13.703	13.703	13.703
Leather group 1	10.733	10.733	10.733	10.733	10.733
Leather group 2	11.317	11.317	11.317	11.317	11.317
Leather group 3	12.347	12.347	12.347	12.347	12.347
Leather group 4	13.582	13.582	13.582	13.582	13.582
Leather group 5	15.620	15.620	15.620	15.620	15.620

Fabric consumption: 11,5 m. Leather consumption: 17,42 m²

Recommended upholstery

Fabric group 1	Bardal, Ruskin, Linara, Capture, Remix, Re-wool, Grand Linen, Erik
Fabric group 2	Hallingdal, Sunniva, Fiord, Savoy, Clay, Barnum, Steelcut Trio, Foss, Loop
Fabric group 3	Divina Melange, Vidar
Fabric group 4	Sisu, Safire
Fabric group 5	Gentle
Leather group 1	Omni
Leather group 2	Primo, Trace
Leather group 3	Max
Leather group 4	Vegeta, Nubuck, Organic, Cera

Model 2213

Mogensen 2213 Sofa 3 seater



Designed by Børge Mogensen, 1962

Fully upholstered sofa with piping in all stitches. Available in leather or fabric. Fixed legs of solid wood, built into the wood internal frame. Seat is supported with jute and rubber band webbing. Separate seat, back and arm cushions with removable covers. Please specify cushion type. Cushions are either with foam core with down wrap or filled with a foam and down mix in separate chambers

Model details

2,4 m³ Packaging dimensions:
157 kg / 73 kg L: 245 cm W: 96 cm H: 102 cm

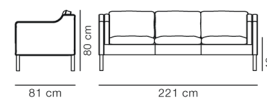

Essential Assortment

Item number	Upholstery	Wood	Price
22131645008810	Leather Primo 88, Black	Walnut oiled	12.499
22131035009010	Leather Vegeta 90, Natural	Oak soap	14.999
22131055090610	Leather Organic 906, Mocca	Oak oil	14.999
22131075084110	Leather Cera 905, Russet brown	Oak light oil	14.999

Essential variants only delivered with HR foam

Order configuration

	Oak soap	Oak oiled	Oak light oil	Oak black lacquered	Walnut oiled
Fabric group 1	11.208	11.208	11.208	11.208	11.208
Fabric group 2	12.027	12.027	12.027	12.027	12.027
Fabric group 3	12.847	12.847	12.847	12.847	12.847
Fabric group 4	14.369	14.369	14.369	14.369	14.369
Fabric group 5	16.127	16.127	16.127	16.127	16.127
Leather group 1	13.718	13.718	13.718	13.718	13.718
Leather group 2	14.504	14.504	14.504	14.504	14.504
Leather group 3	15.790	15.790	15.790	15.790	15.790
Leather group 4	17.369	17.369	17.369	17.369	17.369
Leather group 5	19.974	19.974	19.974	19.974	19.974

Fabric consumption: 12,5 m. Leather consumption: 20,9 m²

Recommended upholstery

Fabric group 1	Bardal, Ruskin, Linara, Capture, Remix, Re-wool, Grand Linen, Erik
Fabric group 2	Hallingdal, Sunniva, Fiord, Savoy, Clay, Barnum, Steelcut Trio, Foss, Loop
Fabric group 3	Divina Melange, Vidar
Fabric group 4	Sisu, Safire
Fabric group 5	Gentle
Leather group 1	Omni
Leather group 2	Primo, Trace
Leather group 3	Max
Leather group 4	Vegeta, Nubuck, Organic, Cera

Model 2292

Mogensen Coupé Sofa 2 seater



Designed by Børge Mogensen, 1971

Fully upholstered sofa with piping in all stitches. Available in leather or fabric. Fixed legs of solid wood, built into the wood internal frame. Seat is supported with jute and rubber band webbing. Separate seat, back and arm cushions with removable covers. Please specify cushion type. Cushions are either with foam core with down wrap or filled with a foam and down mix in separate chambers

Model details

1,8 m³ Packaging dimensions:
75 kg / 65 kg L: 170 cm W: 93 cm H: 113 cm

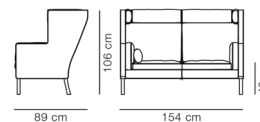

Essential Assortment

Item number	Upholstery	Wood	Price
2292164500881001	Leather Primo 88, Black	Walnut oiled	15.299
2292103500901001	Leather Vegeta 90, Natural	Oak soap	18.699
2292105509061001	Leather Organic 906, Mocca	Oak oil	18.699
2292107508411001	Leather Cera 905, Russet brown	Oak light oil	18.699

Essential variants only delivered with HR foam

Order configuration

	Oak soap	Oak oiled	Oak light oil	Oak black lacquered	Walnut oiled
Fabric group 1	12.053	12.053	12.053	12.053	12.053
Fabric group 2	13.158	13.158	13.158	13.158	13.158
Fabric group 3	14.262	14.262	14.262	14.262	14.262
Fabric group 4	16.312	16.312	16.312	16.312	16.312
Fabric group 5	18.681	18.681	18.681	18.681	18.681
Leather group 1	15.371	15.371	15.371	15.371	15.371
Leather group 2	15.707	15.707	15.707	15.707	15.707
Leather group 3	17.695	17.695	17.695	17.695	17.695
Leather group 4	19.465	19.465	19.465	19.465	19.465
Leather group 5	22.384	22.384	22.384	22.384	22.384

Fabric consumption: 14,1 m. Leather consumption: 26,13 m²

Incl. 1 cushion.

Recommended upholstery

Fabric group 1	Bardal, Ruskin, Linara, Capture, Remix, Re-wool, Grand Linen, Erik
Fabric group 2	Hallingdal, Sunniva, Fiord, Savoy, Clay, Barnum, Steelcut Trio, Foss, Loop
Fabric group 3	Divina Melange, Vidar
Fabric group 4	Sisu, Safire
Fabric group 5	Gentle
Leather group 1	Omni
Leather group 2	Primo, Trace
Leather group 3	Max
Leather group 4	Vegeta, Nubuck, Organic, Cera

Model 2202

Mogensen Ottoman



Designed by Børge Mogensen, 1963

Fully upholstered ottoman with piping in all stitches. Available in leather or fabric. Fixed legs of solid wood, built into the wood internal frame. Seat is supported with polyamide webbing. Separate seat cushion with removable cover. Please specify cushion type. Cushions are either with foam core with down wrap or filled with a foam and down mix in separate chambers

Modeldetails

0,2 m³ Packaging dimensions:
11 kg / 9 kg L: 60 cm W: 60 cm H: 55 cm

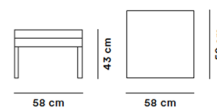

Essential Assortment

Item number	Upholstery	Wood	Price
22021645008810	Leather Primo 88, Black	Walnut oiled	2.083
22021035009010	Leather Vegeta 90, Natural	Oak soap	2.333
22021055090610	Leather Organic 906, Mocca	Oak oil	2.333
22021075084110	Leather Cera 905, Russet brown	Oak light oil	2.333

Essential variants only delivered with HR foam

Order configuration

	Oak soap	Oak oiled	Oak light oil	Oak black lacquered	Walnut oiled
Fabric group 1	1.960	1.960	1.960	1.960	1.960
Fabric group 2	2.097	2.097	2.097	2.097	2.097
Fabric group 3	2.234	2.234	2.234	2.234	2.234
Fabric group 4	2.488	2.488	2.488	2.488	2.488
Fabric group 5	2.781	2.781	2.781	2.781	2.781
Leather group 1	2.133	2.133	2.133	2.133	2.133
Leather group 2	2.204	2.204	2.204	2.204	2.204
Leather group 3	2.426	2.426	2.426	2.426	2.426
Leather group 4	2.669	2.669	2.669	2.669	2.669
Leather group 5	3.069	3.069	3.069	3.069	3.069

Fabric consumption: 2,5 m. Leather consumption: 3,13 m²

Recommended upholstery

Fabric group 1	Bardal, Ruskin, Linara, Capture, Remix, Re-wool, Grand Linen, Erik
Fabric group 2	Hallingdal, Sunniva, Fiord, Savoy, Clay, Barnum, Steelcut Trio, Foss, Loop
Fabric group 3	Divina Melange, Vidar
Fabric group 4	Sisu, Safire
Fabric group 5	Gentle
Leather group 1	Omni
Leather group 2	Primo, Trace
Leather group 3	Max
Leather group 4	Vegeta, Nubuck, Organic, Cera

Model 2333

Mogensen 2333 Sofa 3 seater



Designed by Børge Mogensen, 1971

Fully upholstered sofa, available in leather or fabric. Fixed legs of solid wood, built into the wood internal frame. Seat is supported with polyamide webbing. Separate seat, back and arm cushions with removable covers. Cushions has foam core with down wrap. Leather sofas has piping in all stitches and fabric sofas are made with double stitch.

Modeldetails

2,4 m³ Packaging dimensions:
152 kg / 68 kg L: 245 cm W: 96 cm H: 102 cm

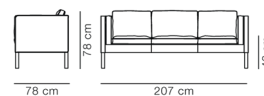

Order configuration

	Oak light oil	Oak black lacquered
Fabric group 1	6.973	6.973
Fabric group 2	7.324	7.324
Fabric group 3	7.962	7.962
Fabric group 4	8.438	8.438
Fabric group 5	10.125	10.125
C.O.M. fabric	6.973	6.973
Leather group 1	10.919	10.919
Leather group 2	12.322	12.322
Leather group 3	13.779	13.779
Leather group 4	15.157	15.157
Leather group 5	17.430	17.430
C.O.M. leather	10.919	10.919

Fabric consumption: 11 m. Leather consumption: 20,9 m²

The sofa is delivered without piping, when upholstered in fabric.

Extra charge for

Fabric or leather piping for furniture with fabric: +655
Oak lacquered, oak soap, oak oiled or stained legs: +353

Recommended upholstery

Fabric group 1 Remix, Bardal, Re-wool, Linara, Ruskin, Capture, Grand Linen, Erik
Fabric group 2 Hallingdal, Loop, Steelcut Trio, Sunniva, Foss, Fiord, Clay, Barnum
Fabric group 3 Divina Melange, Vidar, Elle
Fabric group 4 Sisu, Safire
Fabric group 5 Gentle
Leather group 1 Omni
Leather group 2 Primo
Leather group 3 Max
Leather group 4 Nubuck, Organic, Vegeta, Cera

Model 2335

Mogensen 2335 Sofa 2½ seater



Designed by Børge Mogensen, 1996

Fully upholstered sofa, available in leather or fabric. Fixed legs of solid wood, built into the wood internal frame. Seat is supported with polyamide webbing. Separate seat, back and arm cushions with removable covers. Cushions has foam core with down wrap. Leather sofas has piping in all stitches, fabric sofas are made with double stitch.

Modeldetails

1,94 m³ Packaging dimensions:
126 kg / 60 kg L: 192 cm W: 97 cm H: 104 cm

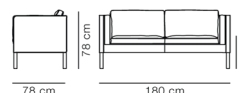

Order configuration

	Oak light oil	Oak black lacquered
Fabric group 1	6.428	6.428
Fabric group 2	6.754	6.754
Fabric group 3	7.415	7.415
Fabric group 4	7.870	7.870
Fabric group 5	9.444	9.444
C.O.M. fabric	6.428	6.428
Leather group 1	9.615	9.615
Leather group 2	11.018	11.018
Leather group 3	12.557	12.557
Leather group 4	13.813	13.813
Leather group 5	15.885	15.885
C.O.M. leather	9.615	9.615

Fabric consumption: 10,5 m. Leather consumption: 20,07 m²

Design: Børge Mogensen Studio

The sofa is delivered without piping, when upholstered in fabric.

Extra charge for

Fabric or leather piping for furniture with fabric: +553
Oak lacquered, oak soap, oak oiled or stained legs: +353

Recommended upholstery

Fabric group 1 Remix, Bardal, Re-wool, Linara, Ruskin, Capture, Grand Linen, Erik
Fabric group 2 Hallingdal, Loop, Steelcut Trio, Sunniva, Foss, Fiord, Clay, Barnum
Fabric group 3 Divina Melange, Vidar, Elle
Fabric group 4 Sisu, Safire
Fabric group 5 Gentle
Leather group 1 Omni
Leather group 2 Primo
Leather group 3 Max
Leather group 4 Nubuck, Organic, Vegeta, Cera

Model 4901

Nami Sofa End module 100x98 cm, Arm L or R



Designed by Damian Williamson, 2023

Fully upholstered sofa module. Inner frame of wood with cold cured foam. Cushions are fixed to the body of the sofa and all covers are non-removable. Legs in black lacquered ash mounted with felt glides. Mounted with coupling device for modular configurations. Please specify right- or left.

All sofa configurations must be finished with a right or left end module.

Modeldetails

0,84 m³ Packaging dimensions:
60 kg / L: 97 cm W: 82 cm H: 105 cm
52 kg

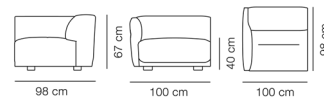

Essential Assortment

Item number	Upholstery	Legs	Module type	Price
4901016700270037900	Loop 36	Blask ash	Right module	2.716
4901016700280037900	Loop 36	Blask ash	Left module	2.716
4901020390270037900	Zero 0001	Blask ash	Right module	3.191
4901020390280037900	Zero 0001	Blask ash	Left module	3.191

Essential variants only delivered with HR foam

Order configuration

Fabric group 1	2.483
Fabric group 2	2.735
Fabric group 3	2.977
Fabric group 4	3.228
Fabric group 5	3.906
C.O.M. fabric	2.483
Leather group 1	3.606
Leather group 2	3.930
Leather group 3	4.449
Leather group 4	5.155
Leather group 5	6.380
C.O.M. leather	3.606

Fabric consumption: 4 m. Leather consumption: 8 m²

Recommended upholstery

Fabric group 1	Bardal, Capture, Natural Linen, Re-wool, Ruskin
Fabric group 2	Hallingdal, Clay, Barnum, Steelcut Trio, Fiord, Foss, Loop
Fabric group 3	Vidar, Divina Melange, Elle
Fabric group 4	Sisu, Safire
Fabric group 5	Gentle
Leather group 1	Omni
Leather group 2	Primo, Trace
Leather group 3	Max
Leather group 4	Nubuck, Vegeta, Organic

Model 4902

Nami Sofa Seat module 88x98 cm



Designed by Damian Williamson, 2023

Fully upholstered sofa module. Inner frame of wood with cold cured foam. Cushions are fixed to the body of the sofa and all covers are non-removable. Legs in black lacquered ash mounted with felt glides. Mounted with coupling device for modular configurations.

All sofa configurations must be finished with a right or left end module.

Modeldetails

0,74 m³ Packaging dimensions:
48 kg / L: 97 cm W: 82 cm H: 93 cm
40 kg

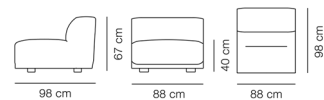

Essential Assortment

Item number	Upholstery	Legs	Price
4902016700000037900	Loop 36	Blask ash	2.366
49020203900000037900	Zero 0001	Blask ash	2.724

Essential variants only delivered with HR foam

Order configuration

Fabric group 1	2.134
Fabric group 2	2.366
Fabric group 3	2.588
Fabric group 4	2.811
Fabric group 5	3.419
C.O.M. fabric	2.134
Leather group 1	3.335
Leather group 2	3.670
Leather group 3	4.205
Leather group 4	4.933
Leather group 5	6.197
C.O.M. leather	3.335

Fabric consumption: 3,5 m. Leather consumption: 8 m²

Recommended upholstery

Fabric group 1	Bardal, Capture, Natural Linen, Re-wool, Ruskin
Fabric group 2	Hallingdal, Clay, Barnum, Steelcut Trio, Fiord, Foss, Loop
Fabric group 3	Vidar, Divina Melange, Elle
Fabric group 4	Sisu, Safire
Fabric group 5	Gentle
Leather group 1	Omni
Leather group 2	Primo
Leather group 3	Max
Leather group 4	Nubuck, Vegeta, Organic

Model 4913

Nami Sofa Corner module 96x96 cm



Designed by Damian Williamson, 2023

Fully upholstered sofa module. Inner frame of wood with cold cured foam. Cushions are fixed to the body of the sofa and all covers are non-removable. Legs in black lacquered ash mounted with felt glides. Mounted with coupling device for modular configurations.

All sofa configurations must be finished with a right or left end module.

Modeldetails

0,81 m³ Packaging dimensions:
68 kg / L: 97 cm W: 82 cm H: 101 cm
60 kg

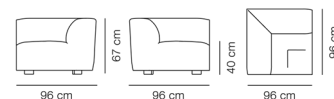

Essential Assortment

Item number	Upholstery	Legs	Price
4913016700000037900	Loop 36	Blask ash	2.833
49130203900000037900	Zero 0001	Blask ash	3.308

Essential variants only delivered with HR foam

Order configuration

Fabric group 1	2.632
Fabric group 2	2.894
Fabric group 3	3.145
Fabric group 4	3.411
Fabric group 5	4.124
C.O.M. fabric	2.632
Leather group 1	3.701
Leather group 2	4.036
Leather group 3	4.571
Leather group 4	5.299
Leather group 5	6.563
C.O.M. leather	3.701

Fabric consumption: 4 m. Leather consumption: 8 m²

Recommended upholstery

Fabric group 1	Bardal, Capture, Natural Linen, Re-wool, Ruskin
Fabric group 2	Hallingdal, Clay, Barnum, Steelcut Trio, Fiord, Foss, Loop
Fabric group 3	Vidar, Divina Melange, Elle
Fabric group 4	Sisu, Safire
Fabric group 5	Gentle
Leather group 1	Omni
Leather group 2	Primo
Leather group 3	Max
Leather group 4	Nubuck, Vegeta, Organic

Model P4900



Konami / Nami Accessories PKiollonawm ci uCsuhsiohnion,

Designed by Damian Williamson, 2019

Decorative cushion for Konami Sofa. Down filling. Removable cover in fabric.

Order configuration

Fabric group 1	310
Fabric group 2	350
Fabric group 3	380
Fabric group 4	425
Fabric group 5	530
C.O.M. fabric	310

Fabric consumption: 0,55 m

Cushion: 50 x 50 cm.

Recommended upholstery

Fabric group 1	Bardal, Re-wool
Fabric group 2	Hallingdal, Clay, Barnum, Loop
Fabric group 3	Vidar, Divina Melange, Elle
Fabric group 4	Sisu, Safire
Fabric group 5	Gentle

Model 2002

No. 1 Sofa 2 seater



Designed by Børge Mogensen, 1955

Fully upholstered sofa with separate seat and back cushions. Interchangeable legs of solid wood mounted with metal threads. Inner frame of solid wood and plywood. Interchangeable cushions of solid CMHR or HR foam covered in fabric and mounted with buttons. Covers are non-removable. Back cushions are reversible with fabric on both sides.

Modeldetails

0,9 m³ Packaging dimensions:
83 kg / 42 kg L: 92 cm W: 148 cm H: 66 cm

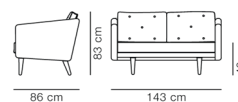

Order configuration

	Oak soap	Oak light oil / Oak oiled	Oak black lacquered / Smoked oak stained, lacquered
Fabric group 1	4.398	4.398	4.398
Fabric group 2	5.018	5.018	5.018
Fabric group 3	5.963	5.963	5.963
Fabric group 4	7.145	7.145	7.145
Fabric group 5	10.288	10.288	10.288
C.O.M. fabric	4.398	4.398	4.398

Fabric consumption: 6,3 m

Certifications

FSC® certified

Recommended upholstery

Fabric group 1	Capture, Re-wool, Bardal, Ruskin, Linara, Remix, Grand Linen, Erik
Fabric group 2	Hallingdal, Savoy, Foss, Sunniva, Barnum, Harald, Steelcut Trio, Fiord, Clay, Loop
Fabric group 3	Divina Melange, Vidar, Elle
Fabric group 4	Safire, Sisu, Grand Mohair
Fabric group 5	Gentle

Model 2003

No. 1 Sofa 3 seater



Designed by Børge Mogensen, 1955

Fully upholstered sofa with separate seat and back cushions. Interchangeable legs of solid wood mounted with metal threads. Inner frame of solid wood and plywood. Interchangeable cushions of solid CMHR or HR foam covered in fabric and mounted with buttons. Covers are non-removable. Back cushions are reversible with fabric on both sides.

Modeldetails

1,2 m³ Packaging dimensions:
88 kg / 54 kg L: 91,5 cm W: 211 cm H: 63 cm

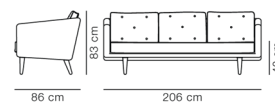

Essential Assortment

Item number	Upholstery	Legs	Price
200316011000050203	Bardal 220	Oak soap treated, FSC Mix 70%	4.833
200316014000050203	Bardal 860	Oak soap treated, FSC Mix 70%	4.833
200316015000050203	Bardal 780	Oak soap treated, FSC Mix 70%	4.833
200300201000050205	Hallingdal 180	Oak oil, FSC Mix 70%	5.833
200300219000050203	Hallingdal 130	Oak soap treated, FSC Mix 70%	5.833

Essential variants only delivered with HR foam

Order configuration

	Oak soap	Oak light oil / Oak oiled	Oak black lacquered / Smoked oak stained, lacquered
Fabric group 1	5.131	5.131	5.131
Fabric group 2	6.013	6.013	6.013
Fabric group 3	7.316	7.316	7.316
Fabric group 4	8.945	8.945	8.945
Fabric group 5	12.882	12.882	12.882
C.O.M. fabric	5.131	5.131	5.131

Fabric consumption: 8,3 m

Certifications

FSC® certified

Recommended upholstery

Fabric group 1	Capture, Re-wool, Bardal, Ruskin, Linara, Remix, Grand Linen, Erik
Fabric group 2	Hallingdal, Savoy, Foss, Sunniva, Barnum, Harald, Steelcut Trio, Fiord, Clay, Loop
Fabric group 3	Divina Melange, Vidar, Elle
Fabric group 4	Safire, Sisù, Grand Mohair
Fabric group 5	Gentle

Model 8802

Savannah Sofa 2 seater



Designed by Monica Förster, 2015

Lounge sofa with upholstered cushions. External frame of solid wood mounted with non-removable upholstery leather or 100% linen canvas. Cushions of cold cured foam upholstered in fabric. Cover is non-removable on frame and back. Cover on seat cushion is removable.

Modeldetails

1,94 m³ Packaging dimensions:
128 kg / 62 kg L: 192 cm W: 97 cm H: 104 cm

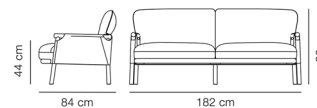

Order configuration

Frame: Oak light oil or oak black lacquered.

	Frame: Canvas	Frame: Leather gr. 1	Frame: Leather gr. 2	Frame: Leather gr. 3	Frame: Leather gr. 4	Frame: Leather gr. 5	Frame: Leather COM
Fabric group 1	5.912	6.041	6.152	6.314	6.476	6.637	6.041
Fabric group 2	6.338	6.467	6.579	6.741	6.902	7.064	6.467
Fabric group 3	6.543	6.673	6.784	6.946	7.108	7.269	6.673
Fabric group 4	7.158	7.288	7.399	7.561	7.723	7.884	7.288
Fabric group 5	8.590	8.719	8.831	8.993	9.154	9.316	8.719
C.O.M. fabric	5.912	6.041	6.152	6.314	6.476	6.637	6.041

Fabric consumption: 6,1 m

Saddle leather on the frame is available in leather group 5.

Note - arm cushions have to be ordered separately (P8801).

Certifications

EN 1022:2005, EN 16139:2013 (L2)

Recommended upholstery

Fabric group 0	Connect
Fabric group 1	Grand Linen, Linara, Bardal, Capture, Re-wool, Ruskin, Erik
Fabric group 2	Hallingdal, Clay, Barnum, Sunniva, Steelcut Trio, Fiord, Foss, Loop
Fabric group 3	Vidar, Divina Melange, Elle
Fabric group 4	Sisu, Safire
Fabric group 5	Gentle

Model P8801

Savannah Accessories Set of 2 arm cushions



Designed by Monica Förster, 2015

Arm cushion in foam upholstered in textile.

Order configuration

Fabric group 1	354
Fabric group 2	387
Fabric group 3	419
Fabric group 4	486
Fabric group 5	549
C.O.M. fabric	354

Fabric consumption: 0,5 m

Recommended upholstery

Fabric group 0	Connect
Fabric group 1	Grand Linen, Linara, Bardal, Capture, Re-wool, Ruskin, Erik
Fabric group 2	Hallingdal, Clay, Barnum, Sunniva, Steelcut Trio, Fiord, Foss, Loop
Fabric group 3	Vidar, Divina Melange, Elle
Fabric group 4	Sisu, Safire
Fabric group 5	Gentle

Model 1712

Spine Lounge Sofa 2 seater



Designed by Space Copenhagen, 2011

Sofa with legs of solid wood. Wooden seat shell of moulded plywood. The seat cushion in CMHR or HR foam. Available in fabric or leather, with piping in all stitches. Cushions are kept in place with Velcro fixtures and are removable for cleaning.

Modeldetails

1,14 m³ Packaging dimensions:
65 kg / 51 kg L: 87 cm W: 168 cm H: 78 cm



Essential Assortment

Item number	Upholstery	Wood	Price
171220200044807	Grand Linen Naturel 0024	Oak lacquer FSC Mix 70%	5.416
171222300050088	Leather Primo 88, Black	Black ash, FSC Mix 70%	5.833
171222300050841	Leather Cera 905, Russet brown	Black ash, FSC Mix 70%	7.499

Essential variants only delivered with HR foam

Order configuration

	Oak lacquered	Black ash	Smoked oak stained, lacquered
Fabric group 0	5.338	4.849	5.204
Fabric group 1	5.739	5.214	5.569
Fabric group 2	6.051	5.525	5.880
Fabric group 3	6.544	6.019	6.374
Fabric group 4	7.368	6.842	7.197
Fabric group 5	7.869	7.352	7.707
C.O.M. fabric	5.739	5.214	5.569
Leather group 0	5.757	5.376	5.730
Leather group 1	6.191	5.780	6.135
Leather group 2	7.073	6.548	6.902
Leather group 3	7.781	7.255	7.610
Leather group 4	8.559	7.981	8.336
Leather group 5	9.843	9.178	9.533
C.O.M. leather	6.191	5.780	6.135

Fabric consumption: 4,8 m. Leather consumption: 10 m²

QuickClick glides with felt upon request (R1730).

Certifications

FSC® certified
EN 15373:2007 (L2)

Recommended upholstery

Fabric group 1	Grand Linen, Linara, Bardal, Capture, Remix, Re-wool, Ruskin, Natural Linen, Erik
Fabric group 2	Hallingdal, Harald, Savoy, Clay, Barnum, Sunniva, Steelcut Trio, Fiord, Foss, Loop
Fabric group 3	Vidar, Divina Melange, Cotil, Elle
Fabric group 4	Sisu, Grand Mohair, Safire
Fabric group 5	Gentle
Leather group 0	Vice
Leather group 1	Omni
Leather group 2	Primo, Trace
Leather group 3	Max
Leather group 4	Nubuck, Organic, Vegeta, Cera

Model 1789

The Spoke-Back Sofa 2 seater



Designed by Børge Mogensen, 1945

Sofa with frame in solid wood. Seat supported by jute webbing. Interchangeable seat and back cushions in solid HR foam, covered in fabric or leather and finished with buttons. Chaise longue angle adjusted and supported with interchangeable leather straps. When covered in fabric the seat cushion is reversible. Leather seat cushion has hessian backing.

Modeldetails

1,18 m³ Packaging dimensions:
35 kg / 33 kg L: 164 cm W: 79 cm H: 91 cm

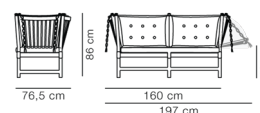

Essential Assortment

Item number	Upholstery	Wood	Price
178920344806301	Natural Linen 0003	Oak soap, FSC Mix 70%	7.499
178920314108301	Capture 4201	Oak soap, FSC Mix 70%	7.499
178920300950301	Cotil 863, 53938	Oak soap, FSC Mix 70%	8.333
178900551301301	Leather Omni 301, Black	Black lacquered	9.999
178920350095301	Leather Max 95, Cognac	Oak soap, FSC Mix 70%	11.666

Essential variants only delivered with HR foam

Order configuration

	Oak soap	Oak oiled	Oak black lacquered	Oak white paint
Fabric group 1	8.254	8.460	7.861	8.585
Fabric group 2	8.412	8.619	8.012	8.743
Fabric group 3	8.599	8.805	8.189	8.930
Fabric group 4	8.795	9.002	8.376	9.126
Fabric group 5	10.554	10.761	10.052	10.885
C.O.M. fabric	8.254	8.460	7.861	8.585
Leather group 1	11.022	11.228	10.497	11.353
Leather group 2	12.257	12.463	11.673	12.588
Leather group 3	14.046	14.252	13.377	14.377
Leather group 4	15.450	15.657	14.715	15.815
Leather group 5	17.768	17.974	16.922	18.187
C.O.M. leather	11.022	11.228	10.497	11.353

Certifications

Oak soap is FSC® certified

Recommended upholstery

Fabric group 1	Grand Linen, Remix, Capture, Bardal, Re-wool, Linara, Ruskin, Natural Linen, Erik
Fabric group 2	Hallingdal, Barnum, Steelcut Trio, Sunniva, Foss, Fiord, Clay, Savoy
Fabric group 3	Cotil, Divina Melange, Vidar, Elle
Fabric group 4	Sisu, Safire
Fabric group 5	Gentle
Leather group 1	Omni
Leather group 2	Primo, Trace
Leather group 3	Max
Leather group 4	Nubuck, Vegeta, Organic, Cera

Model P1789S

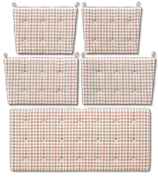

The Spoke-Back Sofa Accessories

Fabric cushions for 1789

Designed by Børge Mogensen

Cushions in solid HR foam, covered in fabric and finished with buttons. When covered in fabric the seat cushion is reversible.

Essential Assortment

Item number	Upholstery	Price
P1789S14108	Capture 4201	1.833
P1789S14112	Capture 5201	1.833
P1789S44806	Natural Linen 0003	1.833
P1789S00950	Cotil 863, 53938	2.083

Essential variants only delivered with HR foam

Order configuration

Fabric group 1	2.128
Fabric group 2	2.279
Fabric group 3	2.457
Fabric group 4	2.643
Fabric group 5	3.171
C.O.M. fabric	2.128

Fabric consumption: 4,5 m

Recommended upholstery

Fabric group 1	Grand Linen, Linara, Bardal, Capture, Remix, Natural Linen, Re-wool, Ruskin, Erik
Fabric group 2	Hallingdal, Clay, Barnum, Sunniva, Steelcut Trio, Fiord, Foss, Savoy
Fabric group 3	Vidar, Divina Melange, Cotil, Elle
Fabric group 4	Sisu, Safire
Fabric group 5	Gentle

Model P1789L



The Spoke-Back Sofa Accessories

Leather cushions for 1789

Designed by Børge Mogensen

Cushions in solid HR foam, covered in leather and finished with buttons. Leather seat cushion has hessian backing.

Essential Assortment

Item number	Upholstery	Price
P1789L51301	Leather Omni 301, Black	4.166
P1789L50095	Leather Max 95, Cognac	5.833

Essential variants only delivered with HR foam

Order configuration

Leather group 1	4.623
Leather group 2	5.703
Leather group 3	7.313
Leather group 4	8.044
Leather group 5	9.251
C.O.M. leather	4.623

Leather consumption: 10 m²

Recommended upholstery

Leather group 1	Omni
Leather group 2	Primo, Trace
Leather group 3	Max
Leather group 4	Nubuck, Vegeta, Organic, Cera

**Model
R1789**

The Spoke-Back Sofa Accessories Leather straps



Designed by Børge Mogensen

Leather straps for The Spoke-Back sofa. Leather straps for adjusting the angle of the chaise longue.

Order configuration

Leatherstraps in
natural each set

146

Tables

Model 6490

Ana Table Extension Table 220/320 cm

Modeldetails

0,3 m³ Packaging dimensions:
80,6 kg / 75 kg L: 228 cm W: 103 cm H: 14 cm



Designed by Arde, 2018

Table with legs of solid wood. Table top of laminated chipboard with solid wood edges, and topped with Fenix nano laminate. Integrated butterfly extension mechanism automatically hides the extension leaves under the table top when not in use. Knock-down, delivered unassembled.

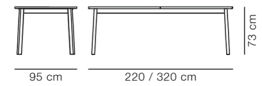

Essential Assortment

Item number	Surface	Frame	Price
649045118255000	Nano laminate white, edge oak soap	Oak soap	3.666
649045417855000	Nano laminat Almond, edge oak clear oil	Oak oil treated	3.666
649045618355000	Black, smoked oak oil stained	Smoked oak oil stained	3.941

Order configuration

	Nano laminate white edge / frame oak soap	Nanolaminate black edge / frame smoked oak oil-stained	Nano laminate almond edge / frame oak oiled
	3.666	3.941	3.666

Certifications

EN 15372:2016 (L1)

Model 6491

Ana Table Ana Extension Table 180/280 cm



Designed by Arde, 2018

Table with legs of solid wood. Table top of laminated chipboard with solid wood edges, and topped with Fenix nano laminate. Integrated butterfly extension mechanism automatically hides the extension leaves under the table top when not in use. Knock-down, delivered unassembled.

Modeldetails

0,27 m³ Packaging dimensions:
69 kg / 66 kg L: 188 cm W: 103 cm H: 14 cm

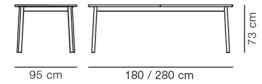

Essential Assortment

Item number	Surface	Frame	Price
649145118255100	Nano laminate white, edge oak soap	Oak soap	3.207
649145417855100	Nano laminat Almond, edge oak clear oil	Oak oil treated	3.207

Order configuration

	Nano laminate white edge / frame oak soap	Nano laminate almond edge / frame oak oiled
	3.207	3.207

Certifications

EN 15372:2016 (L1)

Model 6271

BM71 Library Table Gate leg table



Designed by Børge Mogensen, 1958

Gate-leg table with solid wood frame and veneered oak top in solid frame sections.

Model details

1,03 m³ Packaging dimensions:
100 kg / 60 kg L: 136 cm W: 98 cm H: 77 cm

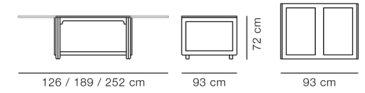

Essential Assortment

Item number	Wood	Price
6271322102	Oak lacquer	5.416
6271322105	Oak oil	5.416

Tabletop length: 126 cm.
Extended: 189 or 252 cm.

Model 6284

BM84 Mogensen Table 180x90 cm



Designed by Børge Mogensen, 1958

Rectangular table with frame and table top in solid wood. Leg mounted with a visible brass screw. Knock-down, delivered unassembled.

Modeldetails

0,18 m³ Packaging dimensions:
43 kg / 40 kg L: 185 cm W: 93 cm H: 10 cm

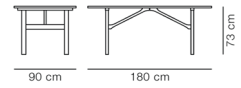

Order configuration

	Oak soap	Oak oiled	Oak light oil	Smoked oak, oiled
	3.856	3.893	3.856	4.434

Certifications

FSC® certified

Model 6286

BM86 Mogensen Shaker Table 195x97.5 cm



Designed by Børge Mogensen, 1964

Rectangular table with frame and table top in solid wood. Leg mounted with a visible brass screw. Knock-down, delivered unassembled.

Modeldetails

0,2 m³ Packaging dimensions:
62 kg / 56 kg L: 203 cm W: 104 cm H: 10 cm



Order configuration

	Oak soap	Oak oiled	Oak light oil	Smoked oak, oiled
	5.549	5.585	5.549	6.381

Model 6386

BM86 Mogensen Shaker Table 245x97.5 cm



Designed by Børge Mogensen, 1964

Rectangular table with frame and table top in solid wood. Leg mounted with a visible brass screw. Knock-down, delivered unassembled.

Modeldetails

0,26 m³ Packaging dimensions:
72 kg / 66 kg L: 265 cm W: 100 cm H: 10 cm

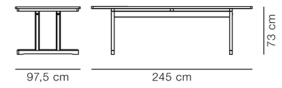

Order configuration

Oak soap	Oak oiled	Oak light oil	Smoked oak, oiled
6.667	6.704	6.667	7.668

**Model
0286**

BM86 Accessories
Additional leaf for 6286 / 6386

Designed by Børge Mogensen

Additional leaf in black lacquered MDF for BM86 table. Brackets in beech wood and black powder coated steel.

Modeldetails

0,14 m³ Packaging dimensions:
7,25 kg / L: 47 cm W: 104 cm H: 16 cm
6 kg

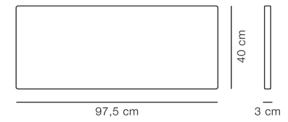

Order configuration

**Black lacquered
(each)**

373

Model 6292

C18 Mogensen Shaker Table 160x80 cm



Designed by Børge Mogensen, 1947

Rectangular table with frame and table top in solid wood. Leg mounted with a visible brass screw. Knock-down, delivered unassembled.

Modeldetails

0,14 m³ Packaging dimensions:
34 kg / 29 kg L: 165 cm W: 83 cm H: 10 cm

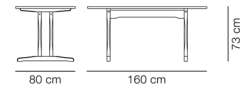

Essential Assortment

Item number	Wood	Price
6292183203	Oak soap, FSC Mix 70%	2.955
6292183205	Oak oil, FSC Mix 70%	2.955
6292183206	Oak light oil, FSC Mix 70%	2.955

Order configuration

	Oak soap	Oak oiled	Oak light oil	Smoked oak, oiled
	2.955	2.955	2.955	3.514

Certifications

FSC® certified

Model 0292

C18 Accessories Additional leaf for 6292

Designed by Børge Mogensen

Additional leaf in black lacquered MDF for C18 table in width 80 cm. Brackets in beech wood and black powder coated steel.

Modeldetails

0,08 m³ Packaging dimensions:
5,7 kg / L: 47 cm W: 86 cm H: 16 cm
4,5 kg

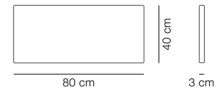

Order configuration

Black lacquered
(each)

373

Model 6290

C18 Mogensen Shaker Table 180x90 cm



Designed by Børge Mogensen, 1947

Rectangular table with frame and table top in solid wood. Leg mounted with a visible brass screw. Knock-down, delivered unassembled.

Modeldetails

0,18 m³ Packaging dimensions:
42,7 kg / 39 kg L: 185 cm W: 93 cm H: 10 cm

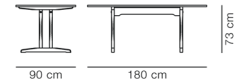

Essential Assortment

Item number	Wood	Price
6290197203	Oak soap, FSC Mix 70%	3.583
6290197205	Oak oil, FSC Mix 70%	3.583
6290197206	Oak light oil, FSC Mix 70%	3.583
6290197207	Smoked oak, oiled, FSC Mix 70%	4.166

Order configuration

	Oak soap	Oak oiled	Oak light oil	Smoked oak, oiled
	3.583	3.583	3.583	4.166

Certifications

FSC® certified

Model 6293

C18 Mogensen Shaker Table 220x90 cm



Designed by Børge Mogensen, 1947

Rectangular table with frame and table top in solid wood. Leg mounted with a visible brass screw. Knock-down, delivered unassembled.

Modeldetails

0,22 m³

Packaging dimensions:

55 kg /
48 kg

L: 230 cm W: 100 cm H: 10 cm

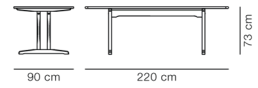

Essential Assortment

Item number	Wood	Price
6293195203	Oak soap, FSC Mix 70%	4.583
6293195205	Oak oil, FSC Mix 70%	4.583
6293195206	Oak light oil, FSC Mix 70%	4.583
6293195207	Smoked oak, oiled, FSC Mix 70%	5.416

Order configuration

	Oak soap	Oak oiled	Oak light oil	Smoked oak, oiled
	4.583	4.583	4.583	5.416

Certifications

FSC® certified

Model 0290

C18 Accessories Additional leaf for C18

Designed by Børge Mogensen

Additional leaf in black lacquered MDF. Brackets in beech wood and black powder coated steel.
Compatible with C18 table width 90 cm and BM84 (6284).

Modeldetails

0,08 m³ Packaging dimensions:
7 kg / 4,5 kg L: 47 cm W: 96 cm H: 16 cm

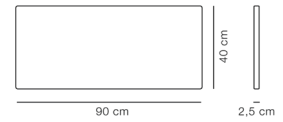

Order configuration

Black lacquered
(each)

373

Model 6775

Islets Table Ø120 cm



Designed by Maria Bruun, 2020

Table with legs and table top of solid hardwood. Legs mounted to table top with metal thread. Knock-down, delivered unassembled. Assembled without the use of screws and tools.

Modeldetails

0,26 m³ Packaging dimensions:
62,5 kg / L: 135/84 cm W: 135/36 cm H: 8/36
54 kg cm

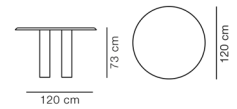

Essential Assortment

Item number	Wood	Price
67752067300	Oak light oil, FSC Mix 70%	5.316
67752077300	Smoked oak, oiled, FSC Mix 70%	5.916

Certifications

FSC® certified

Model 6568

JG Table Ø140 cm



Designed by Jørgen Gammelgaard, 1984

Table with base in stainless steel or powder coated steel. Table top in stone or linoleum. Table tops in linoleum has chipboard core with solid wood edging. Black linoleum with black colored through wood edge. Grey linoleum with light oiled wood edge. Glides included as standard.

Modeldetails

2,1 m³ Packaging dimensions:
130 kg / 87 kg L: 150 / 80 cm W: 150 / 75 cm H: 60 / 8 cm

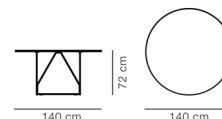

Essential Assortment

Item number	Surface	Frame	Edge	Price
65682150317950340	Black linoleum	Black lacquer	Black oak	2.799
65682140260150340	Grey linoleum	Brushed stainless steel	Natural ash	3.500
65686060017950340	Black Marquina	Black lacquer	without	4.999
65686050060150340	White Carrara	Brushed stainless steel	without	5.699
65686500060150340	Ivory Quartzite	Brushed stainless steel	without	6.999

Order configuration

	Grey linoleum with natural ash edge	Black linoleum with black oak edge	White Carrara	Black Marquina	Ivory Quartzite
Black	2.949	2.799	5.194	4.999	6.532
Stainless steel, brushed	3.500	3.638	5.699	5.884	6.999

Net weight: Linoleum 25 kg, Stone 87 kg.



Extra charge for

Polyester coating of stone table top: +414

Model 6569

JG Table 140x140 cm

Modeldetails

 2,1 m³ Packaging dimensions:
 152 kg / 109 kg L: 150 / 80 cm W: 150 / 75 cm H: 60 / 8 cm



Designed by Jørgen Gammelgaard, 1984

Table with legs in stainless steel or powder coated steel. Table top in stone or linoleum. Table tops in linoleum has chipboard core with solid wood edging. Black linoleum with black colored through wood edge. Grey linoleum with light oiled wood edge. Glides included as standard.

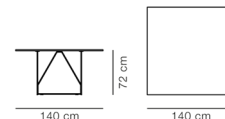

Essential Assortment

Item number	Surface	Frame	Edge	Price
65692150317950440	Black linoleum	Black lacquer	Black oak	2.799
65692140260150440	Grey linoleum	Brushed stainless steel	Natural ash	3.500
65696060017950440	Black Marquina	Black lacquer	without	4.999
65696050060150440	White Carrara	Brushed stainless steel	without	5.499
65696500060150440	Ivory Quartzite	Brushed stainless steel	without	6.999

Order configuration

	Grey linoleum with natural edge	Black linoleum with black oak edge	White Carrara	Black Marquina	Ivory Quartzite
Black	3.015	2.799	5.137	4.999	6.565
Stainless steel, brushed	3.500	3.732	5.499	5.853	6.999

Net weight: Linoleum 31 kg, Stone 109 kg.

Extra charge for

Polyester coating of stone table top: +414

Certifications

EN 15372:2016 (L3)

Model 4681

Pato Table 70x60 cm



Designed by Fredericia Furniture, 2021

Column table in lounge, dining or bar height. Frame in steel and aluminum, polished or powder coated. Table top in stone, solid wood or laminate. Mounted with plastic glides.

Modeldetails

0,26 m³ Packaging dimensions:
35 kg / 30 kg L: 70/56 cm W: 77/56 cm H: 5,5/75 cm

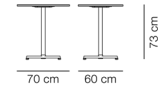

Order configuration

Frame: Polished aluminium or black.

	White Carrara	Black laminate	Oak light oil	Smoked oak, oiled
Height 73 cm	1.106	609	992	1.066

On request:

Other laminate colors and sizes, min. 50 pcs.

Other stone types and sizes, min. 10 pcs.

Other sizes of wood, min. 10 pcs.

Net weight (73 cm):

Stone 30 kg., Laminate 13 kg., Wood 13 kg.

Extra charge for

Polyester coating of stone table top:	+206
UV varnish on wood table top:	+206

Certifications

Oak is FSC® certified

EN 15372:2016 (L2)

Model 4685



Pato Table Ø72 cm

Designed by Fredericia Furniture, 2021

Column table frame in steel and aluminum, polished or powder coated. Table top in stone, solid wood or laminate. Mounted with plastic glides. Available in different heights.

Modeldetails

0,37 m³ Packaging dimensions:
35 kg / 30 kg L: 82/56 cm W: 80/56 cm H: 5,5/107 cm

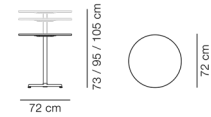

Order configuration

Frame: Polished aluminium or black.
Dining, counter or bar height.

	White Carrara	Black laminate	Oak light oil	Smoked oak, oiled
Height 73 / 95 / 105 cm	1.315	651	1.001	1.075

On request:

Other laminate colors and sizes, min. 50 pcs.

Other stone types and sizes, min. 10 pcs.

Other sizes of wood, min. 10 pcs.

Net weight (73 / 95 / 105 cm):

Stone 29 / 29 / 30 kg., Laminate 13 / 13 / 14 kg., Wood 13 / 13 / 14 kg.

Extra charge for

Polyester coating of stone table top:	+206
UV varnish on wood table top:	+206

Certifications

Oak is FSC® certified

EN 15372:2016 (L2)

Model 4686

Pato Table Ø90 cm



Designed by Fredericia Furniture, 2021

Column table frame in steel and aluminum, polished or powder coated. Table top in stone, solid wood or laminate. Mounted with plastic glides.

Modeldetails

0,29 m³ Packaging dimensions:
47 kg / 42 kg L: 100/56 cm W: 98/56 cm H: 5,5/75 cm



Order configuration

Frame: Polished aluminium or black.

	White Carrara	Black laminate	Oak light oil	Smoked oak, oiled
Height 73 cm	1.627	720	1.216	1.289

On request:

Other laminate colors and sizes, min. 50 pcs.

Other stone types and sizes, min. 10 pcs.

Other sizes of wood, min. 10 pcs.

Net weight (73 cm):

Stone 42 kg., Laminate 16 kg., Wood 17 kg.

Extra charge for

Polyester coating of stone table top:	+414
UV varnish on wood table top:	+206

Certifications

Oak is FSC® certified

EN 15372:2016 (L2)

Model 6631

Plan Table Table 200 x 100 cm

Modeldetails

0,34 m³ Packaging dimensions:
60 kg / L: 87/205 cm W: 87/105,5 cm H:
50 kg 15/15 cm



Designed by Edward Barber & Jay Osgerby, 2022

Table with base in tubular steel, brushed or powder coated. Tabletop in nano laminate, Really textile-plate or solid wood. Std. table tops will be delivered with rounded edge profile. Mounted with plastic glides. No felt glides available. Cable management set and cut out available. Cables can be led through the base leg and the plastic glide included. Cover for cut out available in black powder coated metal or natural saddle leather made from leftovers from the production of The Spanish Chair.

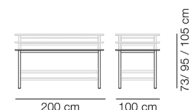

Essential Assortment

Item number	Surface	Frame	Size	Price
663132545804004000	Nano laminate black	Black	Height 73 cm	2.208
663132510704004000	Oak light oil	Black	Height 73 cm	3.399
663132510705004000	Oak light oil	Brushed steel	Height 73 cm	3.983

Order configuration

Frame: Brushed Steel or standard colours: Black, Modernist green, Bordeaux

	Nano laminate black	Really, Cotton Cream	Oak soap	Oak light oil	Oak oil	Oak lacquered	Smoked oak, oiled
Standard colours H73 cm	2.352	2.774	3.497	3.497	3.497	3.799	3.799
Brushed Steel H73 cm	2.955	3.497	4.100	3.983	4.100	4.462	4.462
Standard colours H95 cm	3.256	3.678	4.402	4.402	4.402	4.703	4.703
Brushed Steel H95 cm	4.161	4.703	5.306	5.186	5.306	5.668	5.668
Standard colours H105 cm	3.256	3.678	4.402	4.402	4.402	4.703	4.703
Brushed Steel H105 cm	4.161	4.703	5.306	5.186	5.306	5.668	5.668

For special orders, some table tops will be made with a straight edge that matches the table top.
Spare parts: Glides without felt (R6631G).

Netto weight (73 / 95 / 105 cm):
50 kg / 65 kg / 66 kg

Extra charge for

Cover for cut out in black powder coated steel or natural saddle leather: +354
Incl. cable tray in black powder coated

Certifications

EN 15372:2016 (L3)

Model 6632

Plan Table Extendable 200 / 260 x 100 cm



Designed by Edward Barber & Jay Osgerby, 2022

Extendable table with base in tubular steel, brushed or powder coated. Tabletop in nanolaminate or solid wood and with space for storing an additional plate. Additional plate is the same material as table top. Standard table tops will be delivered with rounded edge profile. Mounted with plastic glides. No felt glides available.

Modeldetails

0,32 m³ Packaging dimensions:
71 kg / L: 87/205 cm W: 87/105,5 cm H:
68 kg 15/15 cm

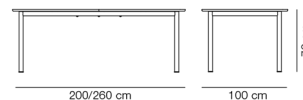

Essential Assortment

Item number	Surface	Frame	Price
663232145804004000	Nano laminate black	Black	2.974
663232110704004000	Oak light oil	Black	3.991
663232110705004000	Oak light oil	Brushed steel	4.674

Order configuration

Frame: Brushed Steel or standard colours: Black, Modernist green, Bordeaux

	Nano laminate black	Oak soap	Oak light oil	Oak oil	Oak lacquered	Smoked oak, oiled
Standard colours H73 cm	3.135	4.100	4.100	4.100	4.402	4.402
Brushed Steel H73 cm	3.919	4.824	4.674	4.824	5.186	5.186

Nettovægt (73 / 95 / 105 cm):
50 kg / 65 kg / 66 kg

Certifications

EN 15372:2016 (L3)

Model 665A

Plan Table Configuration A, 260 x 100 cm

Modeldetails



Designed by Edward Barber & Jay Osgerby, 2022

Base in tubular steel, brushed or powder coated. Tabletop in nano laminate or Really textile table top. Standard table tops will be delivered with rounded edge profile. Mounted with plastic glides. No felt glides available. Cable management set and cut out available. Cables can be led through the base leg and out through the plastic glider included in the Cable management set. Cover for cut out available in black powder coated metal or natural saddle leather made from leftover leather from the production of The Spanish Chair.

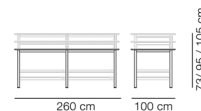

Order configuration

Frame: Brushed Steel or standard colours: Black, Modernist green, Bordeaux

	Nano laminate black	Really, Cotton Cream
Standard colours H73 cm	4.039	4.521
Brushed Steel H73 cm	5.321	6.285
Standard colours H95 cm	5.789	6.271
Brushed Steel H95 cm	7.749	8.713
Standard colours H105 cm	5.789	6.271
Brushed Steel H105 cm	7.749	8.713

For special orders, some table tops will be made with a straight edge that matches the table top.
Spare parts: Glides without felt (R6631G).

Extra charge for

Cover for cut out in black powder coated steel or natural saddle leather (2 pcs.) +708
Incl. 2 cable trays in black powder coated

Certifications

EN 15372:2016 (L3)

Model 665C

Plan Table Configuration C, 320 x 100 cm

Modeldetails



Designed by Edward Barber & Jay Osgerby, 2022

Base in tubular steel, brushed or powder coated. Tabletop in nano laminate or Really textile table top. Standard table tops will be delivered with rounded edge profile. Mounted with plastic glides. No felt glides available. Cable management set and cut out available. Cables can be led through the base leg and out through the plastic glider included in the Cable management set. Cover for cut out available in black powder coated metal or natural saddle leather made from leftover leather from the production of The Spanish Chair.

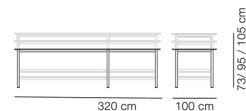

Order configuration

Frame: Brushed Steel or standard colours: Black, Modernist green, Bordeaux

	Nano laminate black	Really, Cotton Cream
Standard colours H73 cm	4.401	5.004
Brushed Steel H73 cm	5.683	6.587
Standard colours H95 cm	6.331	6.934
Brushed Steel H95 cm	8.231	9.135
Standard colours H105 cm	6.331	6.934
Brushed Steel H105 cm	8.231	9.135

For special orders, some table tops will be made with a straight edge that matches the table top.
Spare parts: Glides without felt (R6631G).

Extra charge for

Cover for cut out in black powder coated steel or natural saddle leather (2 pcs.) +708
Incl. 2 cable trays in black powder coated

Certifications

EN 15372:2016 (L3)

Model 665E

Plan Table Configuration E, 380 x 100 cm

Modeldetails



Designed by Edward Barber & Jay Osgerby, 2022

Base in tubular steel, brushed or powder coated. Tabletop in nano laminate or Really textile table top. Standard table tops will be delivered with rounded edge profile. Mounted with plastic glides. No felt glides available. Cable management set and cut out available. Cables can be led through the base leg and out through the plastic glider included in the Cable management set. Cover for cut out available in black powder coated metal or natural saddle leather made from leftover leather from the production of The Spanish Chair.

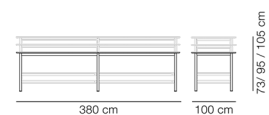

Order configuration

Frame: Brushed Steel or standard colours: Black, Modernist green, Bordeaux

	Nano laminate black	Really, Cotton Cream
Standard colours H73 cm	4.763	5.487
Brushed Steel H73 cm	6.045	6.889
Standard colours H95 cm	6.873	7.597
Brushed Steel H95 cm	8.713	9.557
Standard colours H105 cm	6.873	7.597
Brushed Steel H105 cm	8.713	9.557

For special orders, some table tops will be made with a straight edge that matches the table top.
Spare parts: Glides without felt (R6631G).

Extra charge for

Cover for cut out in black powder coated steel or natural saddle leather (2 pcs.) +708
Incl. 2 cable trays in black powder coated

Certifications

EN 15372:2016 (L3)

Model 665G

Plan Table Configuration G, 440 x 100 cm

Modeldetails

Designed by Edward Barber & Jay Osgerby, 2022



Base in tubular steel, brushed or powder coated. Tabletop in nano laminate or Really textile table top. Standard table tops will be delivered with rounded edge profile. Mounted with plastic glides. No felt glides available. Cable management set and cut out available. Cables can be led through the base leg and out through the plastic glider included in the Cable management set. Cover for cut out available in black powder coated metal or natural saddle leather made from leftover leather from the production of The Spanish Chair.

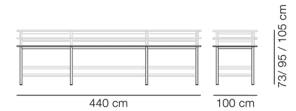

Order configuration

Frame: Brushed Steel or standard colours: Black, Modernist green, Bordeaux

	Nano laminate black	Really, Cotton Cream
Standard colours H73 cm	5.968	6.631
Brushed Steel H73 cm	7.868	9.013
Standard colours H95 cm	8.502	9.165
Brushed Steel H95 cm	11.397	12.542
Standard colours H105 cm	8.502	9.165
Brushed Steel H105 cm	11.397	12.542

For special orders, some table tops will be made with a straight edge that matches the table top.
Spare parts: Glides without felt (R6631G).

Extra charge for

Cover for cut out in black powder coated steel or natural saddle leather (3 pcs.) +1.062
Incl. 3 cable trays in black powder coated

Certifications

EN 15372:2016 (L3)

Model 665M

Plan Table Configuration M, 500 x 100 cm

Modeldetails



Designed by Edward Barber & Jay Osgerby, 2022

Base in tubular steel, brushed or powder coated. Tabletop in nano laminate or Really textile table top. Standard table tops will be delivered with rounded edge profile. Mounted with plastic glides. No felt glides available. Cable management set and cut out available. Cables can be led through the base leg and out through the plastic glider included in the Cable management set. Cover for cut out available in black powder coated metal or natural saddle leather made from leftover leather from the production of The Spanish Chair.

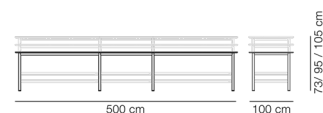

Order configuration

Frame: Brushed Steel or standard colours: Black, Modernist green, Bordeaux

	Nano laminate black	Really, Cotton Cream
Standard colours H73 cm	6.270	7.175
Brushed Steel H73 cm	8.110	9.135
Standard colours H95 cm	9.044	9.949
Brushed Steel H95 cm	11.758	12.783
Standard colours H105 cm	9.044	9.949
Brushed Steel H105 cm	11.758	12.783

For special orders, some table tops will be made with a straight edge that matches the table top.
Spare parts: Glides without felt (R6631G).

Extra charge for

Cover for cut out in black powder coated steel or natural saddle leather (3 pcs.) +1.062
Incl. 3 cable trays in black powder coated

Certifications

EN 15372:2016 (L3)

Model 665K

Plan Table Configuration K, 560 x 100 cm

Modeldetails



Designed by Edward Barber & Jay Osgerby, 2022

Base in tubular steel, brushed or powder coated. Tabletop in nano laminate or Really textile table top. Standard table tops will be delivered with rounded edge profile. Mounted with plastic glides. No felt glides available. Cable management set and cut out available. Cables can be led through the base leg and out through the plastic glider included in the Cable management set. Cover for cut out available in black powder coated metal or natural saddle leather made from leftover leather from the production of The Spanish Chair.

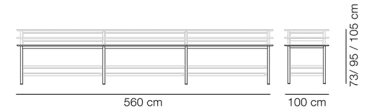

Order configuration

Frame: Brushed Steel or standard colours: Black, Modernist green, Bordeaux

	Nano laminate black	Really, Cotton Cream
Standard colours H73 cm	6.692	7.597
Brushed Steel H73 cm	8.592	9.617
Standard colours H95 cm	9.586	10.491
Brushed Steel H95 cm	12.361	13.386
Standard colours H105 cm	9.586	10.491
Brushed Steel H105 cm	12.361	13.386

For special orders, some table tops will be made with a straight edge that matches the table top.
Spare parts: Glides without felt (R6631G).

Extra charge for

Cover for cut out in black powder coated steel or natural saddle leather (3 pcs.) +1.062
Incl. 3 cable trays in black powder coated

Certifications

EN 15372:2016 (L3)

Model 667B

Plan Table Configuration B, 260 x 120cm

Modeldetails



Designed by Edward Barber & Jay Osgerby, 2022

Base in tubular steel, brushed or powder coated. Tabletop in nano laminate. Standard table tops will be delivered with rounded edge profile. Mounted with plastic glides. No felt glides available.

Cable management set and cut out available. Cables can be led through the base leg and out through the plastic glider included in the Cable management set. Cover for cut out available in black powder coated metal or natural saddle leather made from leftover leather from the production of The Spanish Chair.

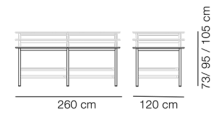

Order configuration

Frame: Brushed Steel or standard colours: Black, Modernist green, Bordeaux

	Nano laminate black
Standard colours H73 cm	4.159
Brushed Steel H73 cm	5.441
Standard colours H95 cm	6.029
Brushed Steel H95 cm	7.869
Standard colours H105 cm	6.029
Brushed Steel H105 cm	7.869

For special orders, some table tops will be made with a straight edge that matches the table top.
Spare parts: Glides without felt (R6631G).

Extra charge for

Cover for cut out in black powder coated steel or natural saddle leather (2 pcs.) +708
Incl. 2 cable trays in black powder coated

Certifications

EN 15372:2016 (L3)

Model 667D

Plan Table Configuration D, 320 x 120cm

Modeldetails



Designed by Edward Barber & Jay Osgerby, 2022

Base in tubular steel, brushed or powder coated. Tabletop in nano laminate. Standard table tops will be delivered with rounded edge profile. Mounted with plastic glides. No felt glides available.

Cable management set and cut out available. Cables can be led through the base leg and out through the plastic glider included in the Cable management set. Cover for cut out available in black powder coated metal or natural saddle leather made from leftover leather from the production of The Spanish Chair.

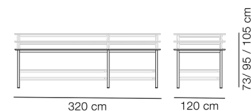

Order configuration

Frame: Brushed Steel or standard colours: Black, Modernist green, Bordeaux

	Nano laminate black
Standard colours H73 cm	4.521
Brushed Steel H73 cm	5.924
Standard colours H95 cm	6.512
Brushed Steel H95 cm	8.532
Standard colours H105 cm	6.512
Brushed Steel H105 cm	8.532

For special orders, some table tops will be made with a straight edge that matches the table top.
Spare parts: Glides without felt (R6631G).

Extra charge for

Cover for cut out in black powder coated steel or natural saddle leather (2 pcs.) +708
Incl. 2 cable trays in black powder coated

Certifications

EN 15372:2016 (L3)

Model 667F

Plan Table Configuration F, 380 x 120cm

Modeldetails



Designed by Edward Barber & Jay Osgerby, 2022

Base in tubular steel, brushed or powder coated. Tabletop in nano laminate. Standard table tops will be delivered with rounded edge profile. Mounted with plastic glides. No felt glides available.

Cable management set and cut out available. Cables can be led through the base leg and out through the plastic glider included in the Cable management set. Cover for cut out available in black powder coated metal or natural saddle leather made from leftover leather from the production of The Spanish Chair.

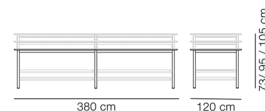

Order configuration

Frame: Brushed Steel or standard colours: Black, Modernist green, Bordeaux

	Nano laminate black
Standard colours H73 cm	4.883
Brushed Steel H73 cm	6.407
Standard colours H95 cm	6.995
Brushed Steel H95 cm	9.195
Standard colours H105 cm	6.995
Brushed Steel H105 cm	9.195

For special orders, some table tops will be made with a straight edge that matches the table top.
Spare parts: Glides without felt (R6631G).

Extra charge for

Cover for cut out in black powder coated steel or natural saddle leather (2 pcs.) +708
Incl. 2 cable trays in black powder coated

Certifications

EN 15372:2016 (L3)

Model 667H

Plan Table Configuration H, 440 x 120cm

Modeldetails



Designed by Edward Barber & Jay Osgerby, 2022

Base in tubular steel, brushed or powder coated. Tabletop in nano laminate. Standard table tops will be delivered with rounded edge profile. Mounted with plastic glides. No felt glides available.

Cable management set and cut out available. Cables can be led through the base leg and out through the plastic glider included in the Cable management set. Cover for cut out available in black powder coated metal or natural saddle leather made from leftover leather from the production of The Spanish Chair.

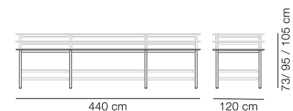

Order configuration

Frame: Brushed Steel or standard colours: Black, Modernist green, Bordeaux

	Nano laminate black
Standard colours H73 cm	6.148
Brushed Steel H73 cm	8.048
Standard colours H95 cm	8.803
Brushed Steel H95 cm	11.577
Standard colours H105 cm	8.803
Brushed Steel H105 cm	11.577

For special orders, some table tops will be made with a straight edge that matches the table top.
Spare parts: Glides without felt (R6631G).

Extra charge for

Cover for cut out in black powder coated steel or natural saddle leather (3 pcs.) +1.062
Incl. 3 cable trays in black powder coated

Certifications

EN 15372:2016 (L3)

Model 667J

Plan Table Configuration J, 500 x 120cm

Modeldetails



Designed by Edward Barber & Jay Osgerby, 2022

Base in tubular steel, brushed or powder coated. Tabletop in nano laminate. Standard table tops will be delivered with rounded edge profile. Mounted with plastic glides. No felt glides available.

Cable management set and cut out available. Cables can be led through the base leg and out through the plastic glider included in the Cable management set. Cover for cut out available in black powder coated metal or natural saddle leather made from leftover leather from the production of The Spanish Chair.

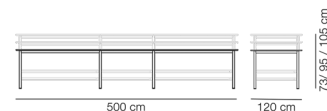

Order configuration

Frame: Brushed Steel or standard colours: Black, Modernist green, Bordeaux

	Nano laminate black
Standard colours H73 cm	6.450
Brushed Steel H73 cm	8.532
Standard colours H95 cm	9.226
Brushed Steel H95 cm	12.300
Standard colours H105 cm	9.226
Brushed Steel H105 cm	12.300

For special orders, some table tops will be made with a straight edge that matches the table top.
Spare parts: Glides without felt (R6631G).

Extra charge for

Cover for cut out in black powder coated steel or natural saddle leather (3 pcs.) +1.062
Incl. 3 cable trays in black powder coated

Certifications

EN 15372:2016 (L3)

Model 667L

Plan Table Configuration L, 560 x 120cm

Modeldetails



Designed by Edward Barber & Jay Osgerby, 2022

Base in tubular steel, brushed or powder coated. Tabletop in nano laminate. Standard table tops will be delivered with rounded edge profile. Mounted with plastic glides. No felt glides available.

Cable management set and cut out available. Cables can be led through the base leg and out through the plastic glider included in the Cable management set. Cover for cut out available in black powder coated metal or natural saddle leather made from leftover leather from the production of The Spanish Chair.

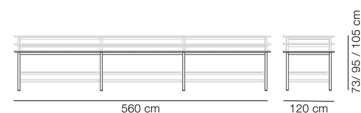

Order configuration

Frame: Brushed Steel or standard colours: Black, Modernist green, Bordeaux

	Nano laminate black
Standard colours H73 cm	6.872
Brushed Steel H73 cm	9.014
Standard colours H95 cm	9.769
Brushed Steel H95 cm	12.903
Standard colours H105 cm	9.769
Brushed Steel H105 cm	12.903

For special orders, some table tops will be made with a straight edge that matches the table top.
Spare parts: Glides without felt (R6631G).

Extra charge for

Cover for cut out in black powder coated steel or natural saddle leather (3 pcs.) +1.062
Incl. 3 cable trays in black powder coated

Certifications

EN 15372:2016 (L3)

Plan Table - Overview

Model 665A, Configuration: A
MODEL 6652 / 6652 + 1 pcs. 6650

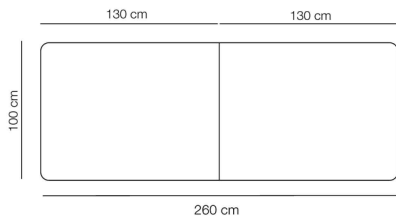

Model 667B, Configuration: B
MODEL 6672 / 6672 + 1 pcs. 6670

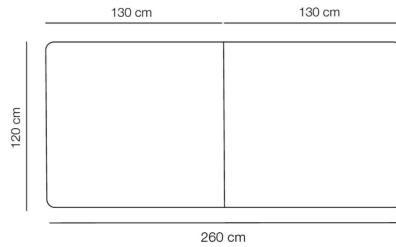

Model 665C, Configuration: C
MODEL 6652 / 6651 + 1 pcs. 6650

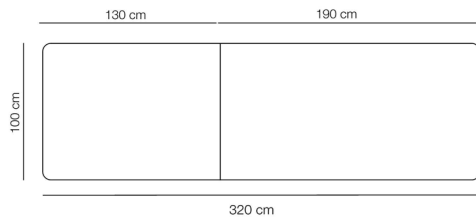

Model 667D, Configuration: D
MODEL 6672 / 6671 + 1 pcs. 6670

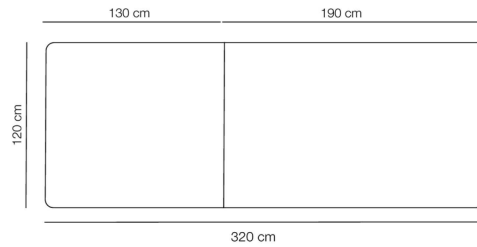

Model 665E, Configuration: E
MODEL 6651 / 6651 + 1 pcs. 6650

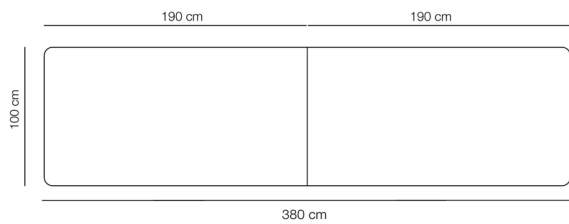

Model 667F, Configuration: F
MODEL 6671 / 6671 + 1. pcs. 6670

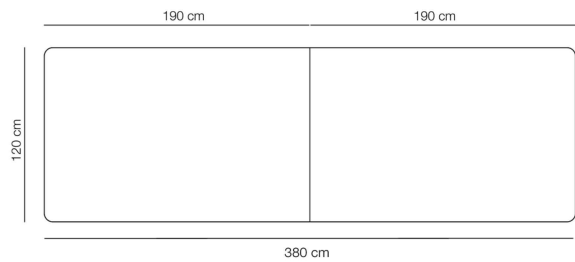

Model 665G, Configuration: G
MODEL 6652 / 6654 / 6652 + 2. pcs. 6650

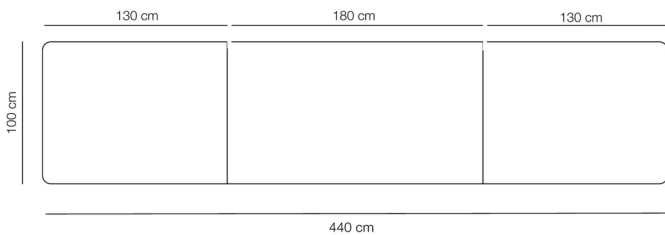

Model 667H, Configuration: H
MODEL 6672 / 6674 / 6672 + 2. pcs 6670

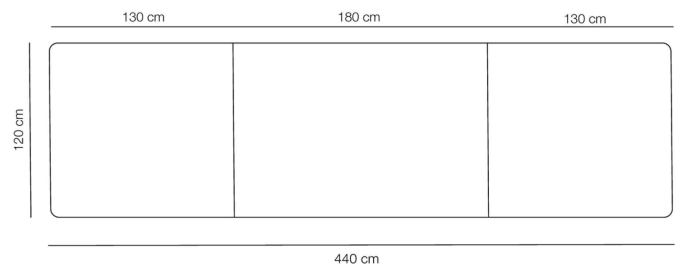

For customer's own configuration, please attach to the order a visual sketch of the desired layout

Plan Table - Overview

Model 665M, Configuration: M
MODEL 6651 / 6655 / 6651 + 2. pcs 6650

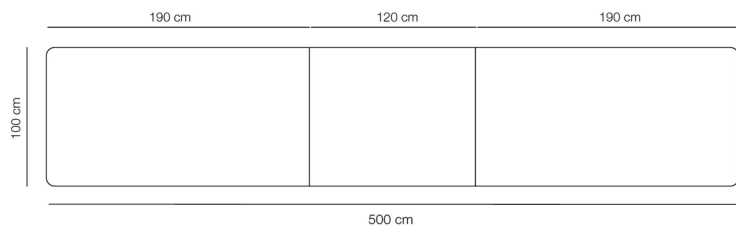

Model 667J, Configuration: J
MODEL 6671 / 6675 / 6671 + 2. pcs 6670

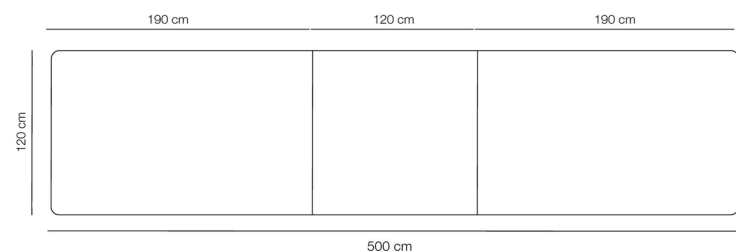

Model 665K, Configuration: K
MODEL 6651 / 6654 / 6651 + 2. pcs 6650

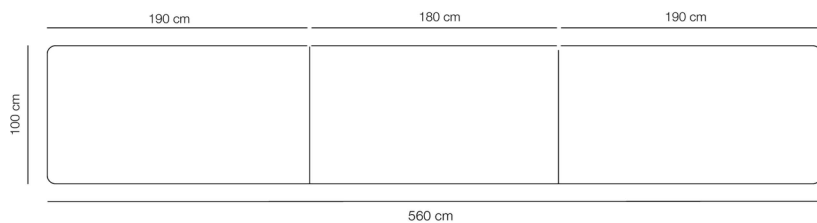

Model 667L, Configuration: L
MODEL 6671 / 6674 / 6671 + 2. pcs 6670

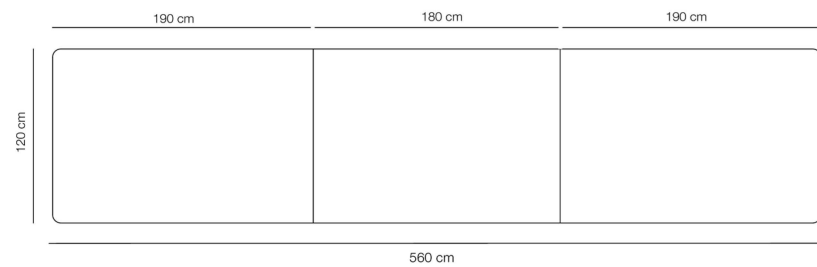

For customer's own configuration, please attach to the order a visual sketch of the desired layout

Model 6624

Plan Table Column 70x60 cm



Designed by Edward Barber & Jay Osgerby, 2023

Column table. Frame in powder coated steel and aluminum. Table top in stone with a full rounded edge profile and solid wood or laminate with a straight edge. Delivered with felt glides. Available in different heights.

Model details

46 kg /
41 kg

Packaging dimensions:

L: 55 / 65 cm W: 55 / 75 cm H: 10 /
5 cm

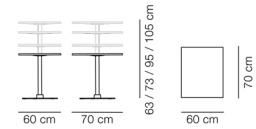

Order configuration

Height: 63, 73, 95 or 105 cm.

	WhiteCarrara	Black laminate	Oak lightoil	Smoked oak,oiled
Black	1.182	591	886	1.004
Modernist green	1.182	591	886	1.004
Bordeaux	1.182	591	886	1.004

Net weight (63 / 73 / 95 / 105 cm):

Stone 40 / 40 / 40 / 41 kg., Laminate 22 / 22 / 23 / 23 kg., Wood 23 / 23 / 24 / 24 kg.

Extra charge for

Polyester coating of stone table top:	+206
UV varnish on wood table top:	+206

Certifications

Oak is FSC® certified
EN 15372:2016 (L3)

Model
6627

Plan Table
Column Ø72 cm

Model details

45 kg /
40 kg

Packaging dimensions:
L: 55 cm W: 55 cm H: 10 cm



Designed by Edward Barber & Jay Osgerby, 2003

Column table. Frame in powder coated steel and aluminum. Table top in stone with a full rounded edge profile and solid wood or laminate with a straight edge. Delivered with felt glides. Available in different heights.

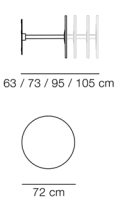

Order configuration

Height: 63, 73, 95 or 105 cm.

	White Carrara	Blacklaminate	Oak lightoil	Smoked oak,oiled
Black	1.395	650	945	1.064
Moderist green	1.395	650	945	1.064
Bordeaux	1.395	650	945	1.064

Net weight (63 / 73 / 95 / 105 cm):

Stone 39 / 39 / 40 / 40 Kg., Laminate 22 / 22 / 23 / 23 Kg., Wood 23 / 23 / 24 / 24 Kg.

Extra charge for

Polyester coating of stone table top:

+206

UV varnish on wood table top:

+206

Certifications

Oak is FSC® certified

EN 15372:2016 (L3)

Model 6629



Plan Table Column Ø90 cm

Designed by Edward Barber & Jay Osgerby, 2023

Column table. Frame in powder coated steel and aluminum. Table top in stone with a full rounded edge profile and solid wood or laminate with a straight edge. Delivered with felt glides. Available in different heights.

Modeldetails

57 kg /
52 kg

Packaging dimensions:

L: 55 cm W: 55 cm H: 10 cm



Order configuration

Height: 63, 73, 95 or 105 cm.

	White Carrara	Blacklamine	Oak lightoil	Smoked oak,oiled
Black	1.773	709	1.123	1.182
Modernist green	1.773	709	1.123	1.182
Bordeaux	1.773	709	1.123	1.182

Net weight (63 / 73 / 95 / 105 cm):

Stone 51 / 52 / 52 / 52 kg., Laminate 25 / 25 / 25 / 26 kg., Wood 27 / 27 / 27 / 28 kg.

Extra charge for

Polyester coating of stone table top: +206
UV varnish on wood table top: +206

Certifications

Oak is FSC® certified
EN 15372:2016 (L3)

Model 6438

Post Table 225x100 cm



Designed by Cecilie Manz, 2019

Legs and table top in solid wood. Knock-down, delivered unassembled.

Modeldetails

0,41 m³ Packaging dimensions:
80 kg / L: 108/234 cm W: 79/108 cm H:
71,5 kg 15/11 cm

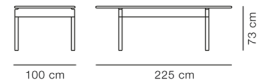

Essential Assortment

Item number	Wood	Price
6438452206	Oak light oil, FSC Mix 70%	3.999
6438452207	Smoked oak, oiled, FSC Mix 70%	4.916

Order configuration

	Oak soap	Oak light oil	Oak lacquered	Smoked oak, oiled
	4.220	3.999	4.426	4.916

Certifications

FSC® certified
EN 15372:2016 (L2)

Model 6440

Post Table 265x100 cm



Designed by Cecilie Manz, 2019

Legs and table top in solid wood. Knock-down, delivered unassembled.

Modeldetails

0,45 m³ Packaging dimensions:
91 kg / L: 108/269 cm W: 79/108 cm H:
76,5 kg 15/11 cm

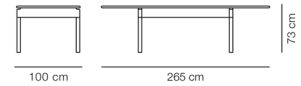

Essential Assortment

Item number	Wood	Price
6440451206	Oak light oil, FSC Mix 70%	4.999
6440451207	Smoked oak, oiled, FSC Mix 70%	5.833

Order configuration

	Oak soap	Oak light oil	Oak lacquered	Smoked oak, oiled
	5.138	4.999	5.344	5.833

Certifications

FSC® certified
EN 15372:2016 (L2)

Model 6441

Post Table 270x100 cm



Designed by Cecilie Manz, 2019

Legs and table top in solid wood. Knock-down, delivered unassembled.

Modeldetails

0,5 m³ Packaging dimensions:
94,5 kg / 80 kg L: 108/274 cm W: 79/108 cm H: 15/11 cm

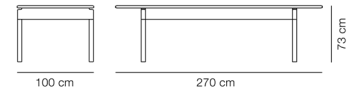

Essential Assortment

Item number	Wood	Price
6441453206	Oak light oil, FSC Mix 70%	4.999
6441453207	Smoked oak, oiled, FSC Mix 70%	5.833

Order configuration

	Oak soap	Oak light oil	Oak lacquered	Smoked oak, oiled
	5.138	4.999	5.344	5.833

Certifications

FSC® certified
EN 15372:2016 (L2)

Model 6442

Post Table 320x100 cm



Designed by Cecilie Manz, 2019

Legs and table top in solid wood. Knock-down, delivered unassembled.

Modeldetails

0,52 m³ Packaging dimensions:
106 kg / L: 108/329 cm W: 79/108 cm H:
85,5 kg 15/11 cm

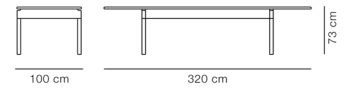

Order configuration

Oak soap	Oak light oil	Oak lacquered	Smoked oak, oiled
6.621	6.621	6.838	7.945

Certifications

FSC® certified
EN 15372:2016 (L2)

Model 6106

Taro Table 220x93.5 cm



Designed by Jasper Morrison, 2016

Rectangular table with legs and table top in solid wood. Knock-down, delivered unassembled.

Modeldetails

0,33 m³ Packaging dimensions:
57 kg / 54 kg L: 228 cm W: 102 cm H: 11 cm

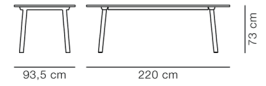

Order configuration

	Oak soap	Oak oiled	Oak light oil	Oak lacquered	Smoked oak, oiled
	4.800	4.839	4.800	5.019	5.505

Certifications

FSC® certified
EN 15372:2008 (L3)

Model 6119

Taro Table Ø90 cm



Designed by Jasper Morrison, 2016

Small circular table for three chairs, with legs and table top in solid wood. Three-legged construction. Knock-down, delivered unassembled.

Modeldetails

0,2 m³ Packaging dimensions:
24 kg / 20 kg L: 105/93 cm W: 94/78 cm H: 11/12 cm

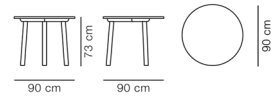

Order configuration

Oak soap	Oak oiled	Oak light oil	Oak lacquered	Smoked oak, oiled
2.484	2.521	2.484	2.691	2.882

Certifications

FSC® certified

Model 6121

Taro Table Ø120 cm



Designed by Jasper Morrison, 2016

Small table with legs and table top in solid wood. Knock-down, delivered unassembled.

Modeldetails

0,38 m³ Packaging dimensions:
51 kg / 41,5 kg L: 135 cm W: 135 cm H: 5,5 cm

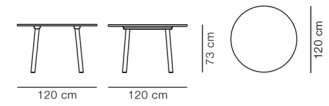

Order configuration

	Oak soap	Oak oiled	Oak light oil	Oak lacquered	Smoked oak, oiled
	2.988	3.025	2.988	3.194	3.436

Certifications

FSC® certified

Coffee & Side Tables

Model 5367

BM67 Coffee Table



Designed by Børge Mogensen, 1956

Coffee table. Frame in solid wood, with brackets in solid brass or powder coated steel. Table top in solid oak or veneered walnut with solid wood edges. Knock-down, delivered unassembled.

Modeldetails

0,1 m³ Packaging dimensions:
18 kg / L: 143 cm W: 58 cm H: 12 cm
14,75 kg

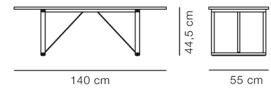

Essential Assortment

Item number	Wood	Frame	Price
536710790313300	Oak light oil	Brackets in brass	1.833
536716490313300	Walnut oiled	Brackets in brass	2.274

Order configuration

	Oak soap	Oak oil	Oak light oil	Smoked oak, oiled	Walnut oiled
Brackets: Black	1.934	2.011	1.934	2.151	2.395
Brackets: Brass	1.934	2.011	1.833	2.151	2.274

Model 5190

Insula Coffee Table 72x76 cm

Designed by Ernst & Jensen, 2009

Coffee table in solid aluminum finished with textured powder coating. Mounted with plastic glides. Knock down, delivered unassembled.



Modeldetails

0,05 m³ Packaging dimensions:
12 kg / 10 kg L: 86 cm W: 77 cm H: 6 cm

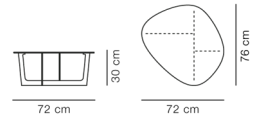

Essential Assortment

Item number	Surface	Price
51903013013000	Aluminium, textured black lacquer	1.083

Certifications

EN 15372:2008 (L2)

Model 5191

Insula Coffee Table 95x98 cm

Designed by Ernst & Jensen, 2009

Coffee table in solid aluminum finished with textured powder coating. Mounted with plastic glides. Knock down, delivered unassembled.



Modeldetails

0,08 m³ Packaging dimensions:
19 kg / 16 kg L: 110 cm W: 95 cm H: 6 cm

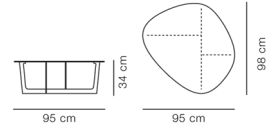

Essential Assortment

Item number	Surface	Price
51913013013400	Aluminium, textured black lacquer	1.416

Certifications

EN 15372:2008 (L2)

Model 5192

Insula Coffee Table 118x121 cm



Designed by Ernst & Jensen, 2009

Coffee table in solid aluminum finished with textured powder coating. Mounted with plastic glides. Knockdown, delivered unassembled.

Modeldetails

0,6 m³ Packaging dimensions:
30 kg / 26 kg L: 126 cm W: 103 cm H: 45 cm

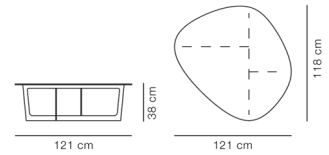

Essential Assortment

Item number	Surface	Price
51923013013800	Aluminium, textured black lacquer	2.291

Certifications

EN 15372:2008 (L2)

Model 5198

Insula Piccolo Table Side table



Designed by Ernst & Jensen, 2014

Side table in two heights. Tabletop in aluminum, base in steel. Finished with textured powder coating. Mounted with natural fibre glides, as an alternative to felt. Please specify table height.

Model details

0,2 m³ Packaging dimensions:
15,5 kg / 8 kg L: 47 cm W: 46 cm H: 76 cm

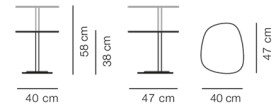

Essential Assortment

Item number	Surface	Height	Price
51983013015800	Aluminium, textured black lacquer	58 cm	749

Order configuration

Frame: Black aluminium.

Table top:
Aluminium
black

Height: 38 cm	812
Height: 58 cm	749

Model 6770

Islets Side Table 40x40 cm



Designed by Maria Bruun, 2020

Side table with legs and table top of solid hardwood. Legs mounted to table top with metal thread. Knock-down, delivered assembled.

Modeldetails

0,05 m³ Packaging dimensions:
11 kg / 9 kg L: 55/55 cm W: 55/21 cm H: 8/21 cm

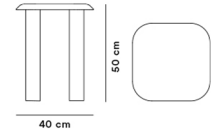

Essential Assortment

Item number	Wood	Price
67701075200	Oak light oil	1.541
67702075200	Smoked oak, oiled, FSC Mix 70%	1.666

Certifications

Smoked oak is FSC® certified

Model 6772

Islets Coffee Table 110x110 cm

Designed by Maria Bruun, 2020

Coffee table with legs and table top of solid hardwood. Legs mounted to table top with metal thread. Knock-down, delivered assembled.



Modeldetails

0,15 m³ Packaging dimensions:
35,5 kg / 28 kg L: 125/35 cm W: 125/25 cm H: 8/25 cm

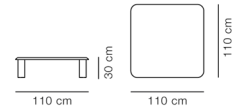

Essential Assortment

Item number	Wood	Price
67722063000	Oak light oil, FSC Mix 70%	3.208
67722073000	Smoked oak, oiled, FSC Mix 70%	3.324

Certifications

FSC® certified

**Model
6558**

JG Coffee Table
Ø98 cm



Designed by Jørgen Gammelgaard, 1962

Coffee table with base in solid aluminium, brushed and finished with a clear powder coating. Tabletop in 16 mm tempered low-iron glass. Mounted with plastic glides. Knock-down, delivered unassembled.

Modeldetails

0,12 m³ Packaging dimensions:
33 kg / L: 102 / 58 cm W: 102 / 31 cm H: 8 /
30 kg 18 cm

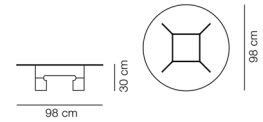

Order configuration

2,125

Model 6804

Niveau Coffee Table Ø45 cm



Designed by Cecilie Manz, 2023

Table top in 20 mm stone. Base in solid wood done with a hollow construction. Table top is attached to base with metal thread. Delivered with felt glides. Delivered disassembled. Available in different heights.

Modeldetails

0,08 m³ Packaging dimensions:
22 kg / 17 kg L: 32/57 cm W: 32/57,5 cm H: 42/10,5 cm

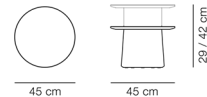

Essential Assortment

Item number	Surface	Frame	Size	Price
680460618690779	Black Marquina	Ash brown stained oil treated, FSC Mix 70%	Ø45 cm, height 29 cm	1.183
680460618690879	Black Marquina	Ash brown stained oil treated, FSC Mix 70%	Ø45 cm, height 42 cm	1.183
680461118590779	Tundra Grey	Ash oil treated, FSC Mix 70%	Ø45 cm, height 29 cm	1.183
680461118590879	Tundra Grey	Ash oil treated, FSC Mix 70%	Ø45 cm, height 42 cm	1.183

Order configuration

Height: 29 or 42 cm.

	Tundra Grey	Black Marquina
Ash oil treated	1.183	1.235
Ash brown stained	1.235	1.183

Extra charge for

Polyester coating of stone table top: +206

Certifications

FSC® certified
EN 15372:2016 (L2)

Model 6806

Niveau Coffee Table

Ø61 cm



Designed by Cecilie Manz, 2023

Table top in 20 mm stone. Base in solid wood done with a hollow construction. Table top is attached to base with metal thread. Delivered with felt glides. Delivered disassembled.

Modeldetails

0,1 m³ Packaging dimensions:
32,5 kg / 23 kg L: 32/73 cm W: 32/73,5 cm H: 42/10,5 cm

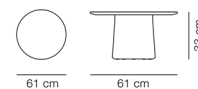

Essential Assortment

Item number	Surface	Frame	Size	Price
680660618690679	Black Marquina	Ash brown stained oil treated, FSC Mix 70%	Ø61 cm, height 33 cm	1.541
680661118590679	Tundra Grey	Ash oil treated, FSC Mix 70%	Ø61 cm, height 33 cm	1.541

Order configuration

	Tundra Grey	Black Marquina
Ash oil treated	1.541	1.601
Ash brown stained	1.601	1.541

Extra charge for

Polyester coating of stone table top: +206

Certifications

FSC® certified

Model 6811

Niveau Coffee Table Ø110 cm



Designed by Cecilie Manz, 2023

Table top in 20 mm sten. Base in solid wood done with a hollow construction. Table top is attached to base with metal thread. Delivered with felt glides. Delivered disassembled.

Modeldetails

0,31 m³ Packaging dimensions:
112 kg / 68 kg L: 62/122 cm W: 62/122,5 cm H:
38/11 cm

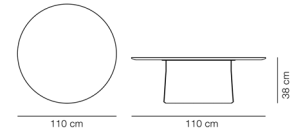

Essential Assortment

Item number	Surface	Frame	Size	Price
681160618690979	Black Marquina	Ash brown stained oil treated, FSC Mix 70%	Ø110 cm, height 38 cm	3.541
681161118590979	Tundra Grey	Ash oil treated, FSC Mix 70%	Ø110 cm, height 38 cm	3.541

Order configuration

	Grey Tundra	Black Marquina
Ash oil treated	3.541	3.603
Ash brown stained	3.603	3.541

Extra charge for

Polyester coating of stone table top: +414

Certifications

FSC® certified
EN 15372:2016 (L2)

Model
6751

Pal Side Table

Ø37.5 cm

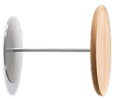

Designed by Keiji Takeuchi, 2020

Side table with table top in solid wood, base in stainless steel or powder coated steel. Table top is attached to base with metal thread. Delivered disassembled. Mounted with felt glides. Available in different heights.

Model details

0,07 m³ Packaging dimensions:
8,6 kg / L: 41/32 cm W: 41/32 cm H:
7,1 kg 6/41/48/55 cm

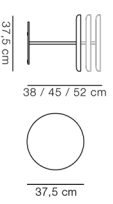

Essential Assortment

Item number	Wood	Frame	Size	Price
675120617938300	Oak light oil, FSC Mix 70%	Black lacquer	Height 45 cm	499
675116417938300	Walnut oiled	Black lacquer	Height 45 cm	583
675120660138300	Oak light oil, FSC Mix 70%	Brushed stainless steel	Height 45 cm	624
675116460138300	Walnut oiled	Brushed stainless steel	Height 45 cm	749

Order configuration

Available in three heights: 38, 45 or 52 cm.

	Oak light oil	Oak lacquered	Oak black lacquered	Walnut oil	Walnut lacquered
Black	515	618	515	622	725
Stainless steel, brushed	673	777	673	793	896

Certifications

Oak is FSC® certified
EN 15372:2016 (L2)

Model 6755

Pal Side Table Ø44 cm



Designed by Keiji Takeuchi, 2020

Sidetable with table top in solid wood, base in stainless steel or powder coated steel. Table top is attached to base with metal thread. Delivered disassembled. Mounted with felt glides. Available in different heights.

Modeldetails

0,07 m³ Packaging dimensions:
9,25 kg / L: 48/32 cm W: 48/32 cm H:
7,75 kg 6/41/48/55 cm

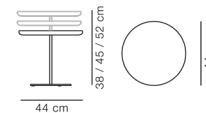

Essential Assortment

Item number	Wood	Frame	Size	Price
675520617938700	Oak light oil, FSC Mix 70%	Black lacquer	Height 52 cm	558
675516417938700	Walnut oiled	Black lacquer	Height 52 cm	658
675520660138700	Oak light oil, FSC Mix 70%	Brushed stainless steel	Height 52 cm	699
675516460138700	Walnut oiled	Brushed stainless steel	Height 52 cm	816

Order configuration

Available in three heights: 38, 45 or 52 cm.

	Oak light oil	Oak lacquered	Oak black lacquered	Walnut oil	Walnut lacquered
Black	560	668	560	680	788
Stainless steel, brushed	723	831	723	856	964

Certifications

Oak is FSC® certified
EN 15372:2016 (L2)

Model 6798

Piloti Wood Coffee Table Nest of tables

Modeldetails



Designed by Hugo Passos, 2016

Coffee tables with legs and table top in solid hardwood. Legs mounted to table top with metal thread. Knock-down, delivered unassembled. Assembled without the use of screws and tools.

Essential Assortment

Item number	Combination	Wood	Price
6798011206	Piloti Small nest, 6700 (H35) + 6705 (H41)	Oak light oil, FSC Mix 70%	749
6798011224	Piloti Small nest, 6700 (H35) + 6705 (H41)	Oak black lacquer, FSC Mix 70%	749
6798011207	Piloti Small nest, 6700 (H35) + 6705 (H41)	Smoked oak, oiled, FSC Mix 70%	833
6798012206	Piloti Medium nest, 6705 (H41) + 6715 (H35)	Oak light oil, FSC Mix 70%	1.083
6798012224	Piloti Medium nest, 6705 (H41) + 6715 (H35)	Oak black lacquer, FSC Mix 70%	1.083
6798012207	Piloti Medium nest, 6705 (H41) + 6715 (H35)	Smoked oak, oiled, FSC Mix 70%	1.249
6798013206	Piloti Large nest, 6720 (H41) + 6725 (H35)	Oak light oil, FSC Mix 70%	1.499
6798013224	Piloti Large nest, 6720 (H41) + 6725 (H35)	Oak black lacquer, FSC Mix 70%	1.499
6798013207	Piloti Large nest, 6720 (H41) + 6725 (H35)	Smoked oak, oiled, FSC Mix 70%	1.541

Certifications

FSC® certified
EN 15372:2016 (L1)

Model 6700

Piloti Wood Coffee Table 39x31 cm



Designed by Hugo Passos, 2016

Legs and table top in solid hardwood. Legs mounted to table top with metal thread. Knock-down, delivered unassembled. Assembled without the use of screws and tools. Available in two heights, please specify 35 cm or 41 cm.

Model details

0,02 m³ Packaging dimensions:
3,3 kg / 2,3 kg L: 47 cm W: 38 cm H: 10 cm

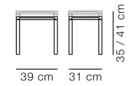

Essential Assortment

Item number	Wood	Height	Price
67002063500	Oak light oil, FSC Mix 70%	35 cm	358
67002243500	Oak black lacquer, FSC Mix 70%	35 cm	358
67002073500	Smoked oak, oiled, FSC Mix 70%	35 cm	399

Order configuration

Height: 35 or 41 cm.

	Oak soap	Oak oiled	Oak light oil	Oak lacquered	Oak black lacquered	Smoked oak, oiled
	449	449	373	586	373	428

Certifications

FSC® certified
EN 15372:2016 (L1)

Model 6705

Piloti Wood Coffee Table 46.5x39 cm



Designed by Hugo Passos, 2016

Legs and table top in solid hardwood. Legs mounted to table top with metal thread. Knock-down, delivered unassembled. Assembled without the use of screws and tools. Available in two heights, please specify 35 cm or 41 cm.

Model details

0,03 m³ Packaging dimensions:
4,7 kg / 2,8 kg L: 56 cm W: 46 cm H: 10 cm

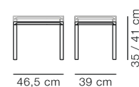

Essential Assortment

Item number	Wood	Height	Price
67052064100	Oak light oil, FSC Mix 70%	41 cm	483
67052244100	Oak black lacquer, FSC Mix 70%	41 cm	483
67052074100	Smoked oak, oiled, FSC Mix 70%	41 cm	566

Order configuration

Height: 35 or 41 cm.

	Oak soap	Oak oiled	Oak light oil	Oak lacquered	Oak black lacquered	Smoked oak, oiled
	550	550	511	620	511	588

Certifications

FSC® certified
EN 15372:2016 (L1)

Model 6715

Piloti Wood Coffee Table 120x39 cm



Designed by Hugo Passos, 2016

Legs and table top in solid hardwood. Legs mounted to table top with metal thread. Knock-down, delivered unassembled. Assembled without the use of screws and tools. Available in two heights, please specify 35 cm or 41 cm.

Model details

0,06 m³ Packaging dimensions:
9,5 kg / 6,3 kg L: 128 cm W: 46 cm H: 10 cm

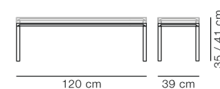

Essential Assortment

Item number	Wood	Height	Price
67152063500	Oak light oil, FSC Mix 70%	35 cm	791
67152243500	Oak black lacquer, FSC Mix 70%	35 cm	791
67152073500	Smoked oak, oiled, FSC Mix 70%	35 cm	874

Order configuration

Height: 35 or 41 cm.

Oak soap	Oak oiled	Oak light oil	Oak lacquered	Oak black lacquered	Smoked oak, oiled
861	861	822	931	822	946

Certifications

FSC® certified
EN 15372:2016 (L1)

Model 6720

Piloti Wood Coffee Table 75x75 cm



Designed by Hugo Passos, 2016

Legs and table top in solid hardwood. Legs mounted to table top with metal thread. Knock-down, delivered unassembled. Assembled without the use of screws and tools. Available in two heights, please specify 35 cm or 41 cm.

Modeldetails

0,06 m³ Packaging dimensions:
11,7 kg / 10 kg L: 82 cm W: 81 cm H: 10 cm

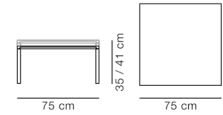

Essential Assortment

Item number	Wood	Height	Price
67202064100	Oak light oil, FSC Mix 70%	41 cm	874
67202244100	Oak black lacquer, FSC Mix 70%	41 cm	874
67202074100	Smoked oak, oiled, FSC Mix 70%	41 cm	1.008

Order configuration

Height: 35 or 41 cm.

	Oak soap	Oak oiled	Oak light oil	Oak lacquered	Oak black lacquered	Smoked oak, oiled
	952	952	913	1.022	913	1.050

Certifications

FSC® certified
EN 15372:2016 (L1)

Model 6725

Piloti Wood Coffee Table 63x63 cm



Designed by Hugo Passos, 2016

Legs and table top in solid hardwood. Legs mounted to table top with metal thread. Knock-down, delivered unassembled. Assembled without the use of screws and tools. Available in two heights, please specify 35 cm or 41 cm.

Model details

0,05 m³ Packaging dimensions:
8,5 kg / 7,5 kg L: 70 cm W: 69 cm H: 10 cm

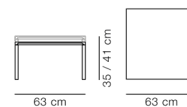

Essential Assortment

Item number	Wood	Height	Price
67252063500	Oak light oil, FSC Mix 70%	35 cm	791
67252243500	Oak black lacquer, FSC Mix 70%	35 cm	791
67252073500	Smoked oak, oiled, FSC Mix 70%	35 cm	874

Order configuration

Height: 35 or 41 cm.

Oak soap	Oak oiled	Oak light oil	Oak lacquered	Oak black lacquered	Smoked oak, oiled
861	861	822	931	822	945

Certifications

FSC® certified
EN 15372:2016 (L1)

Model 6610

Piloti Alu table 75x39 cm



Designed by Hugo Passos, 2021

Coffee table with table top in stone or nano laminate with a black core. Base in powder coated aluminium or brushed aluminium. Mounted with plastic glides, which can be adjusted in height for uneven floors.

Modeldetails

0,06 m³ Packaging dimensions:
18 kg / 16,5 kg L: 83/87 cm W: 46/50,5 cm H: 9/4,5 cm

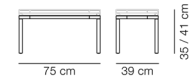

Order configuration

Frame: Black or brushed aluminium.

Height: 35 or 41 cm.

	Black laminate	White Carrara	Black Marquina
Black	946	1.322	1.322
Brushed aluminium	1.230	1.678	1.678

Extra charge for

Polyester coating of stone table top: +206

Certifications

EN 15372:2016 (L3)

Model 6615

Piloti Alu table 120x39 cm



Designed by Hugo Passos, 2021

Coffee table with table top in stone or nano laminate with a black core. Base in powder coated aluminium or brushed aluminium. Mounted with plastic glides, which can be adjusted in height for uneven floors.

Modeldetails

0,08 m³ Packaging dimensions:
27,5 kg / 24 kg L: 127/132 cm W: 46/51 cm H: 8/4,5 cm

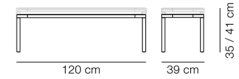

Order configuration

Frame: Black or brushed aluminium.

Height: 35 or 41 cm.

	Black laminate	White Carrara	Black Marquina
Black	1.113	1.672	1.672
Brushed aluminium	1.454	1.901	1.901

Extra charge for

Polyester coating of stone table top: +206

Certifications

EN 15372:2016 (L3)

Model 6620

Piloti Alu table 75x75 cm



Designed by Hugo Passos, 2021

Coffee table with table top in stone or nano laminate with a black core. Base in powder coated aluminium or brushed aluminium. Mounted with plastic glides, which can adjusted in height for uneven floors.

Modeldetails

0,09 m³ Packaging dimensions:
32 kg / 29,5 kg L: 82/87 cm W: 83/88 cm H: 8/4,5 cm

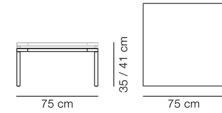

Order configuration

Frame: Black or brushed aluminium.

Height: 35 or 41 cm.

	Black laminate	White Carrara	Black Marquina
Black	1.113	1.672	1.672
Brushed aluminium	1.454	1.901	1.901

Extra charge for

Polyester coating of stone table top: +206

Certifications

EN 15372:2016 (L3)

Model 1280

Pon Side Table Ø35 cm



Designed by Jasper Morrison, 2016

Side table in solid wood. Table top, column and base are joined with steel rods. The table can be disassembled for maintenance. Delivered assembled.

Model details

0,06 m³ Packaging dimensions:
8,5 kg / 7,5 kg L: 38,5 cm W: 38,5 cm H: 39,5 cm

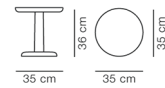

Essential Assortment

Item number	Wood	Price
12802053600	Oak oil, FSC Mix 70%	641
12802063600	Oak light oil, FSC Mix 70%	641
12802073600	Smoked oak, oiled, FSC Mix 70%	732

Order configuration

	Oak soap	Oak oiled	Oak light oil	Smoked oak, oiled	Oak lacquered	Oak black lacquered
	683	641	641	732	796	751

Certifications

FSC® certified

Model 1285

Pon Side Table Ø40 cm



Designed by Jasper Morrison, 2016

Side table in solid wood. Table top, column and base are joined with steel rods. The table can be disassembled for maintenance. Delivered assembled.

Model details

0,11 m³ Packaging dimensions:
9,6 kg / 8,4 kg L: 43,5 cm W: 43,5 cm H: 44,5 cm

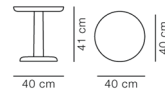

Essential Assortment

Item number	Wood	Price
12852054100	Oak oil, FSC Mix 70%	699
12852064100	Oak light oil, FSC Mix 70%	699
12852074100	Smoked oak, oiled, FSC Mix 70%	791

Order configuration

	Oak soap	Oak oiled	Oak light oil	Smoked oak, oiled	Oak lacquered	Oak black lacquered
	738	699	699	791	847	823

Certifications

FSC® certified

Model 1290

Pon Side Table Ø45 cm



Designed by Jasper Morrison, 2016

Side table in solid wood. Table top, column and base are joined with steel rods. The table can be disassembled for maintenance. Delivered assembled.

Modeldetails

0,12 m³ Packaging dimensions:
7,9 kg / 6,6 kg L: 49 cm W: 49 cm H: 50 cm

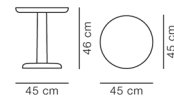

Essential Assortment

Item number	Wood	Price
12902054600	Oak oil, FSC Mix 70%	791
12902064600	Oak light oil, FSC Mix 70%	791
12902074600	Smoked oak, oiled, FSC Mix 70%	874

Order configuration

	Oak soap	Oak oiled	Oak light oil	Smoked oak, oiled	Oak lacquered	Oak black lacquered
	806	791	791	874	915	968

Certifications

FSC® certified

Model 1295

Pon Coffee Table Ø90 cm



Designed by Jasper Morrison, 2016

Coffee table in solid wood. Table top, column and base are joined with steel rod. The table can be disassembled for maintenance. Knock-down, delivered unassembled.

Modeldetails

0,11 m³ Packaging dimensions:
25 kg / 20 kg L: 94 cm W: 105 cm H: 11 cm

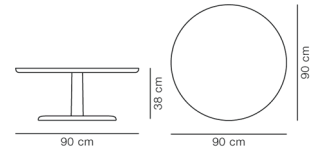

Essential Assortment

Item number	Wood	Price
12952053800	Oak oil, FSC Mix 70%	2.033
12952063800	Oak light oil, FSC Mix 70%	2.033
12952073800	Smoked oak, oiled, FSC Mix 70%	2.474

Order configuration

	Oak soap	Oak oiled	Oak light oil	Smoked oak, oiled	Oak lacquered	Oak black lacquered
	2.199	2.033	2.033	2.474	2.308	2.537

Certifications

FSC® certified

Model 1960

Tableau Table Ø100 cm



Designed by Space Copenhagen, 2018

Fixed position coffee table made from Portuguese limestone. Table top of limestone, reinforced underside with fiber web. Base of intersecting limestone plates. The table must be assembled on site by professionals. Never sit or stand on your marble tabletop and avoid placing particularly heavy items on it.

Modeldetails

1,25 m³ Packaging dimensions:
123 kg / 78 kg L: 108 cm W: 26 cm H: 108 cm

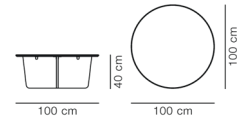

Essential Assortment

Item number	Surface	Price
19606005064000	Dark Atlantico Limestone	3.399

Extra charge for

Polyester coating of stone table top: +414

Model 1966

Tableau Table 100x100 cm



Designed by Space Copenhagen, 2018

Fixed position coffee table made from Portuguese limestone. Table top of limestone, reinforced underside with fiber web. Base of intersecting limestone plates. The table must be assembled on site by professionals. Never sit or stand on your marble tabletop and avoid placing particularly heavy items on it.

Modeldetails

1,55 m³ Packaging dimensions:
128 kg / 83 kg L: 108 cm W: 26 cm H: 108 cm

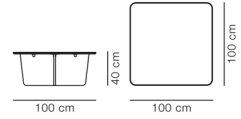

Essential Assortment

Item number	Surface	Price
19666005074000	Dark Atlantico Limestone	3.500

Extra charge for

Polyester coating of stone table top: +414

Model 1965

Tableau Table 140x140 cm



Designed by Space Copenhagen, 2018

Fixed position coffee table made from Portuguese limestone. Table top of limestone, reinforced underside with fiber web. Base of intersecting limestone plates. The table must be assembled on site by professionals. Never sit or stand on your marble tabletop and avoid placing particularly heavy items on it.

Modeldetails

2 m³ Packaging dimensions:
260 kg / L: 148,5 cm W: 26 cm H: 148,5 cm
152 kg

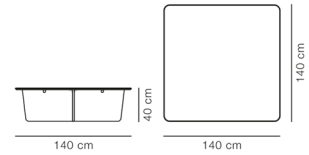

Essential Assortment

Item number	Surface	Price
19656005044000	Dark Atlantico Limestone	5.249

Extra charge for

Polyester coating of stone table top: +414

Model 1028

Wegner Ox Table Ø80 cm

Designed by Hans J. Wegner, 1960

Table top in veneer as per original designed construction. Core of furniture board. Edge in solid wood. Always mounted with plastic glides. Available in two heights, please specify height.



Modeldetails

0,05 m³ Packaging dimensions:
15 kg / 13,6 kg L: 83 / 51 cm W: 83 / 30 cm H: 5,5 / 6 cm

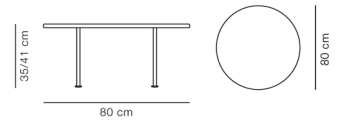

Essential Assortment

Item number	Surface	Frame	Height	Price
10287056013500	Oak oil, FSC Mix 70%	Brushed stainless steel	35 cm	1.266
10287056014100	Oak oil, FSC Mix 70%	Brushed stainless steel	41 cm	1.266
10281646013500	Walnut oil	Brushed stainless steel	35 cm	1.749
10281646014100	Walnut oil	Brushed stainless steel	41 cm	1.749

Order configuration

Height: 35 or 41 cm.

	Oak lacquered	Oak oil	Walnut oil
Stainless steel, brushed	1.433	1.266	1.749

Certifications

Oak is FSC® certified

Model 1020

Wegner Ox Table Ø100 cm



Designed by Hans J. Wegner, 1960

Table top in veneer as per original designed construction. Core of MDF. Edge in solid wood. Always mounted with plastic glides. Available in two heights, please specify height.

Modeldetails

0,07 m³ Packaging dimensions:
20 kg / 18,6 kg L: 103 / 51 cm W: 103 / 30 cm H:
5,5 / 6 cm

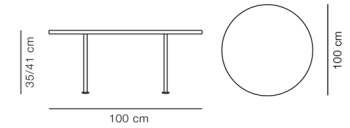

Essential Assortment

Item number	Surface	Frame	Height	Price
10207056013500	Oak oil, FSC Mix 70%	Brushed stainless steel	35 cm	1.749
10207056014100	Oak oil, FSC Mix 70%	Brushed stainless steel	41 cm	1.749
10201646013500	Walnut oil	Brushed stainless steel	35 cm	1.924
10201646014100	Walnut oil	Brushed stainless steel	41 cm	1.924

Order configuration

Height: 35 or 41 cm.

	Oak lacquered	Oak oil	Walnut oil
Stainless steel, brushed	1.819	1.749	1.924

Certifications

Oak is FSC® certified

Model 1022

Wegner Ox Table Ø120 cm



Designed by Hans J. Wegner, 1960

Table top in veneer as per original designed construction. Core of MDF. Edge in solid wood. Always mounted with plastic glides. Available in two heights, please specify height.

Modeldetails

0,1 m³ Packaging dimensions:
28 kg / 24,6 kg L: 123 / 51 cm W: 123 / 51 cm H:
5,5 / 6 cm

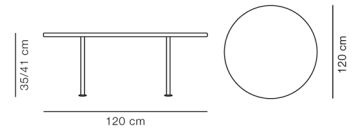

Essential Assortment

Item number	Surface	Frame	Height	Price
10227056013500	Oak oil, FSC Mix 70%	Brushed stainless steel	35 cm	2.016
10227056014100	Oak oil, FSC Mix 70%	Brushed stainless steel	41 cm	2.016
10221646013500	Walnut oil	Brushed stainless steel	35 cm	2.191
10221646014100	Walnut oil	Brushed stainless steel	41 cm	2.191

Order configuration

Height: 35 or 41 cm.

	Oak lacquered	Oak oil	Walnut oil
Stainless steel, brushed	2.095	2.016	2.191

Certifications

Oak is FSC® certified

Model 1025

Wegner Ox Table Ø150 cm



Designed by Hans J. Wegner, 1960

Table top in veneer as per original designed construction. Core of MDF. Edge in solid wood. Always mounted with plastic glides. Available in two heights, please specify height.

Modeldetails

0,15 m³ Packaging dimensions:
39 kg / 35,6 kg L: 153 / 51 cm W: 153 / 51 cm H:
5,5 / 6 cm

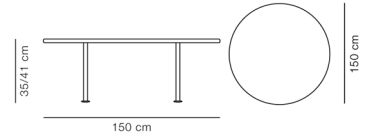

Essential Assortment

Item number	Surface	Frame	Height	Price
10251056013500	Oak oil treated	Brushed stainless steel	35 cm	3.499
10251056014100	Oak oil treated	Brushed stainless steel	41 cm	3.499
10251646013500	Walnut oil	Brushed stainless steel	35 cm	3.941
10251646014100	Walnut oil	Brushed stainless steel	41 cm	3.941

Order configuration

Height: 35 or 41 cm.

	Oak lacquered	Oak oil	Walnut oil
Stainless steel, brushed	3.859	3.499	3.941

Storage

Model 2921



BM29 Shelf

1 compartment, 2 shelves

Designed by Børge Mogensen, 1956

Rails and brackets are solid wood while the shelves are veneer. The shelves are mounted on the rails and brackets using screws. The rails are mounted to the wall with the keyhole fittings and screws. Brass screws for mounting of shelves to rails and to the wall is included. Rawplugs is not included as it depends on the specific type of wall.

Modeldetails

0,02 m³ Packaging dimensions:
9 kg / 7 kg L: 81 cm W: 27 cm H: 8 cm

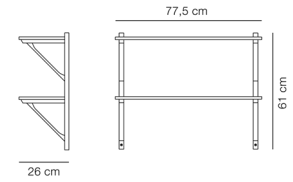

Essential Assortment

Item number	Surface	Price
29215129310400	Oak lacquer	999
29215129316200	Walnut lacquer	1.199

Max load capacity for the shelf is 10 kg per shelf, where the composition of the wall and the mounting of the module allow this. The weight should be distributed evenly.

Model 2901



BM29 Shelf

1 compartment, 3 shelves & desk shelf

Designed by Børge Mogensen, 1956

Rails and brackets are solid wood while the shelves are veneer. The shelves are mounted on the rails and brackets using screws. The rails are mounted to the wall with the keyhole fittings and screws. Brass screws for mounting of shelves to rails and to the wall is included. Rawplugs is not included as it depends on the specific type of wall.

Modeldetails

0,07 m³ Packaging dimensions:
16 kg / L: 137 cm W: 45 cm H: 11 cm
14 kg

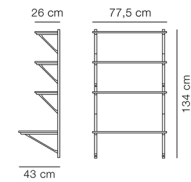

Essential Assortment

Item number	Surface	Price
29015329110400	Oak lacquer	1.999
29015329116200	Walnut lacquer	2.349

Max load capacity for the shelf is 10 kg per shelf, where the composition of the wall and the mounting of the module allow this. The weight should be distributed evenly.

Model 2920

BM29 Shelf

2 compartments, 2 shelves



Designed by Børge Mogensen, 1956

Rails and brackets are solid wood while the shelves are veneer. The shelves are mounted on the rails and brackets using screws. The rails are mounted to the wall with the keyhole fittings and screws. Brass screws for mounting of shelves to rails and to the wall is included. Rawplugs is not included as it depends on the specific type of wall.

Modeldetails

0,05 m³ Packaging dimensions:
13 kg / 11 kg L: 156 cm W: 28 cm H: 11 cm

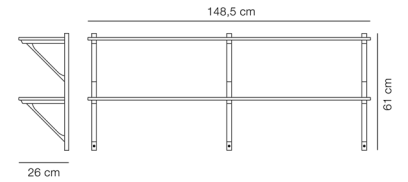

Essential Assortment

Item number	Surface	Price
29205229210400	Oak lacquer	1.599
29205229216200	Walnut lacquer	1.849

Max load capacity for the long shelves is 15 kg per shelf where the composition on the wall and the mounting of the module allow this. The weight should be distributed evenly.

Model 2900



BM29 Shelf

2 compartments, 3 shelves, desk shelf

Designed by Børge Mogensen, 1956

Rails and brackets are solid wood while the shelves are veneer. The shelves are mounted on the rails and brackets using screws. The rails are mounted to the wall with the keyhole fittings and screws. Brass screws for mounting of shelves to rails and to the wall is included. Rawplugs is not included as it depends on the specific type of wall.

Modeldetails

0,1 m³ Packaging dimensions:
26 kg / 24 kg L: 156 cm W: 45 cm H: 14 cm

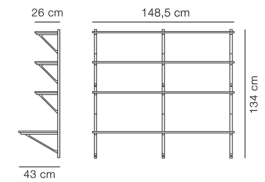

Essential Assortment

Item number	Surface	Price
29005429010400	Oak lacquer	2.899
29005429016200	Walnut lacquer	3.299

Max load capacity is 15 kg per long shelf where the composition of the wall and the mounting of the module allow this. The weight should be distributed evenly.

Complements

Model 5375

BM375 Nesting Tables



Designed by Børge Mogensen, 1962

Side table with base in solid wood and table top in veneer made with box-joints. A nest consists of 3 tables.

Modeldetails

0,13 m³ Packaging dimensions:
13 kg / 11 kg L: 50 cm W: 50 cm H: 52 cm

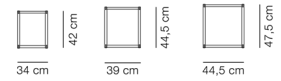

Essential Assortment

Item number	Wood	Description	Price
53752060337500	Oak light oil, FSC Mix 70%	Set of 3	941

Certifications

FSC® certified
EN 15372:2016 (L2)

Model 8110

Fellow Lamp Incl. light bulb G9 LED



Designed by Space Copenhagen, 2020

Base in solid limestone, detail fittings in solid brass. Shade in powder coated steel can turn a maximum of 150 degrees to each side from middle position. Black fabric 255 cm power cord with on/off switch and type C European power plug. Switch located 60 cm from the base. Light source G9 LED light bulb, 220-240 VAC, maximum 4.8W. Bulb included. IP-value: IP50. The lamp is delivered with felt glides glued on.

Modeldetails

0,05 m³ Packaging dimensions:
9 kg / 6,4 kg L: 45 cm W: 36 cm H: 33 cm

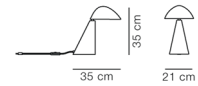

Essential Assortment

Item number	Lampshade	Base	Price
811052010380	White steel	Dark Atlantico Limestone	833

Only for sale in Europe.

Model 8115

Meadow Lamp Excl. light bulb E27



Designed by Space Copenhagen, 2020

Base in solid limestone, detail fittings in solid brass. Shade in mouth blown opal glass, white frosted. Black fabric 280 cm power cord with on/off switch and type C European power plug. Switch located 70 cm from the base. Light source socket is standard E27 and suitable for max. 112 mm light bulbs, voltage 220-240. LED bulbs recommended for lower energy consumption. IP-value: IP50. Bulb is not included. The lamp is delivered with felt glides glued on.

Modeldetails

0,06 m³ Packaging dimensions:
5,5 kg / 2,3 kg L: 45 cm W: 36 cm H: 37 cm

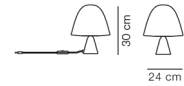

Essential Assortment

Item number	Lampshade	Base	Price
811552110381	White Opal glass	Dark Atlantico Limestone	549

Only for sale in Europe.

Model 1610

Gallery Stool



Designed by Hans Sandgren Jakobsen, 1998

Stool made from a single mould of plywood and fixed with metal joints.

Modeldetails

0,12 m³ Packaging dimensions:
6,1 kg / 4 kg L: 41 cm W: 56 cm H: 54 cm

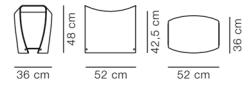

Essential Assortment

Item number	Wood	Price
1610223	Black ash, FSC Mix 70%	824
1610226	Walnut lacquer, FSC Mix 70%	824

Certifications

FSC® certified

Model 8210

Hydro Brass Vase

H: 20 cm



Designed by Sofie Østerby, 2020

Casted solid brass with black oxidised surface treatment. Waterproof. The brass surface acquires patina with use and outer surface should be kept dry to avoid blotches.

Modeldetails

0,01 m³ Packaging dimensions:
3 kg / L: 31 cm W: 31 cm H: 29 cm
2,8 kg

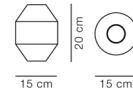

Essential Assortment

Item number	Material	Price
821010	Black-oxide brass	549

Model 8211

Hydro Brass Vase

H: 30 cm



Designed by Sofie Østerby, 2020

Casted solid brass with black oxidised surface treatment. Waterproof. The brass surface acquires patina with use and outer surface should be kept dry to avoid blotches.

Modeldetails

0,03 m³ Packaging dimensions:
5,4 kg / 5 kg L: 31 cm W: 31 cm H: 39 cm

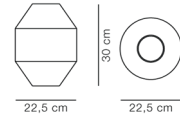

Essential Assortment

Item number	Material	Price
821110	Black-oxide brass	958

Model 8208

Hydro Glass Vase

H: 20 cm



Designed by Sofie Østerby, 2023

Mouthblown vase made from crystalline lead-free glass.

Modeldetails

0,01 m³ Packaging dimensions:
1,2 kg / L: 31 cm W: 31 cm H: 29 cm
0,9 kg

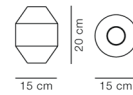

Essential Assortment

Item number	Material	Price
8208400	Glass	108

Model 8209

Hydro Glass Vase

H: 30 cm



Designed by Sofie Østerby, 2023

Mouthblown vase made from crystalline lead-free glass.

Modeldetails

0,03 m³

Packaging dimensions:

2,6 kg /
2,1 kg

L: 31 cm W: 31 cm H: 39 cm

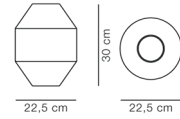

Essential Assortment

Item number	Material	Price
8209400	Glass	166

Model 8215

Locus Bowl Decorative bowl



Designed by Sofie Østerby, 2020

Solid travertine with drilled grooves outer finish. The travertine is natural and without resin fillings, which allows any natural spots or irregular openings in the surface to show. For decoration only. The bowl should be kept away from any acidic products, liquids and foods.

Modeldetails

0,02 m³ Packaging dimensions:
9,8 kg / 8,6 kg L: 48,5 cm W: 48,5 cm H: 15,3 cm

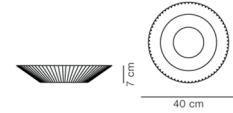

Essential Assortment

Item number	Material	Price
821530	Travertine	1.199

Made from raw travertine. Not suitable for food such as fruits.

Model 6565

JG Stool



Designed by Jørgen Gammelgaard, 1970

Folding stool with base in stainless steel with seat in leather or 100% linen canvas.
Leather seat has canvas backing. No glides available.

Modeldetails

0,02 m³ Packaging dimensions:
6,2 kg / 5,6 kg L: 76 cm W: 48 cm H: 5,5 cm

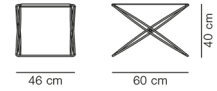

Essential Assortment

Item number	Seat	Frame	Price
65653160100	Natural canvas	Brushed stainless steel	708
65653460100	Leather Max 98, Black	Brushed stainless steel	916
65653560100	Leather Vegeta, Natural	Brushed stainless steel	916
65653660100	Leather Max 95, Cognac SPOOR	Brushed stainless steel	916

Certifications

EN 1022:2005, EN 16139:2013 (L1)

Model 6500

Magazine Table Side table



Designed by Jens Risom, 1949

Three-legged side table. Base and table top in plywood.

Modeldetails

0,14 m³ Packaging dimensions:
6,1 kg / 4,6 kg L: 61 cm W: 44 cm H: 52 cm



Essential Assortment

Item number	Wood	Price
650020200	Oak lacquer FSC Mix 70%	558
650022500	Oak black lacquer, FSC Mix 70%	558

Certifications

FSC® certified

Model 1880



Nara Coat Stand

Designed by Shin Azumi, 2009

Coat stand made from solid wood, designed to utilise scrap wood from table production. Base of powder coated steel.

Modeldetails

0,27 m³ Packaging dimensions:
13 kg / 10 kg L: 34 cm W: 43 cm H: 186 cm

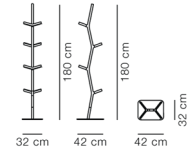

Essential Assortment

Item number	Wood	Base	Price
18802022	Oak lacquer FSC Mix 70%	White	783
18802231	Black ash, FSC Mix 70%	Black	783

Certifications

FSC® certified

Model 6830

Pioneer Stool, H 46 cm



Designed by Maria Bruun, 2023

Stackable stool with a base in solid wood. Seat consists of an inner construction of a MDF core with HR or CMHR foam and upholstered with a removable fabric cover with zippers or non-removable cover in leather. Upholstered seat is removable. Metal screws and fittings. Mounted with plastic glides, felt glides are available.

Modeldetails

0,09 m³ Packaging dimensions:
7 kg / 4 kg L: 42 cm W: 42 cm H: 50 cm

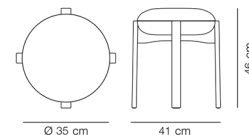

Essential Assortment

Item number	Upholstery	Frame	Price
6830002070854400	Hallingdal 200	Oak lacquer, FSC Mix 70%	591
6830002220855400	Hallingdal 370	Smoked oak stained lacquer, FSC Mix 70%	649
6830020390854400	Zero 0001	Oak lacquer, FSC Mix 70%	708
6830406280855400	Vidar 386	Smoked oak stained lacquer, FSC Mix 70%	708
6830508610855400	Leather Primo 86-1, Dark brown	Smoked oak stained lacquer, FSC Mix 70%	708
6830500900854400	Leather Vegeta 90, Natural	Oak lacquer, FSC Mix 70%	766

Essential variants are delivered with plastic glides and HR foam

Order configuration

	Beech black lacquered	Oak lacquered	Smoked oak stained, lacquered
Fabric group 1	591	650	709
Fabric group 2	620	680	736
Fabric group 3	647	708	764
Fabric group 4	693	755	811
Fabric group 5	785	849	905
C.O.M. fabric	591	650	709
Leather group 1	641	702	758
Leather group 2	665	727	783
Leather group 3	672	731	783
Leather group 4	725	784	837
Leather group 5	817	878	931
C.O.M. leather	641	702	758

Fabric consumption: 0,5 m. Leather consumption: 0,5 m²

Stackable: 6 pcs. on floor.

Certifications

FSC® certified

EN 1022:2005, EN 16139:2013 (L2)

Recommended upholstery

Fabric group 1	Linara, Bardal, Capture, Re-wool, Ruskin, Natural Linen, Erik
Fabric group 2	Hallingdal, Clay, Barnum, Sunniva, Steelcut Trio, Fiord, Foss, Loop
Fabric group 3	Vidar, Divina Melange, Elle
Fabric group 4	Safire
Fabric group 5	Gentle
Leather group 1	Omni
Leather group 2	Primo, Trace
Leather group 3	Max
Leather group 4	Nubuck, Vegeta, Organic

Model 6402

Seto Stool



Designed by Keiji Takeuchi, 2023

Base in solid wood mounted with a non-removable seat in canvas finished with a leather cord. Glides in felt are included.

Modeldetails

0,09 m³ Packaging dimensions:
6 kg / L: 55 cm W: 37 cm H: 45 cm
5,2 kg

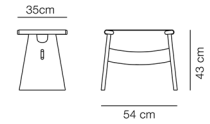

Essential Assortment

Item number	Seat	Frame	Price
64023085337	Black canvas	Oak black lacquer, FSC Mix 70%	708
64023185237	Natural canvas	Oak light oil - FSC Mix 70%	708

Certifications

FSC® certified
EN 1022:2005, EN 16139:2013 (L1)

Model 1756

Sequoia Pouf Ø40 cm



Designed by Space Copenhagen, 2020

Fully upholstered pouf with Inner shell in moulded polyurethane foam, reinforced with a steel frame and wooden base.
Upholstered in textile and mounted with plastic gliders, felt glides are available.

Modeldetails

0,1 m³ Packaging dimensions:
8 kg / 6 kg L: 45 cm W: 45 cm H: 47 cm

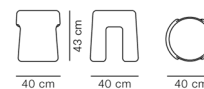

Essential Assortment

Item number	Upholstery	Price
175600481046	Barnum 24, Lana	813
175600205046	Hallingdal 65, 110	813
175649980046	Sheepskin Moonlight	1.166

Essential variants only delivered with HR foam

Order configuration

Fabric group 1	842
Fabric group 2	890
Fabric group 3	932
Fabric group 4	1.016
Fabric group 5	1.123
C.O.M. fabric	842
Sheepskin	1.166

Fabric consumption: 1,1 m

Recommended upholstery

Fabric group 1	Remix, Capture, Bardal, Re-wool, Linara, Ruskin, Grand Linen, Natural Linen, Erik
Fabric group 2	Hallingdal, Barnum, Loop, Steelcut Trio, Sunniva, Foss, Fiord, Clay
Fabric group 3	Divina Melange, Elle, Vidar
Fabric group 4	Sisu, Safire
Fabric group 5	Gentle

Model 8321

Silhouette Mirror Ø55 cm



Designed by OEO Studio, 2020

Mirror with frame in solid wood. 4 mm mirror glass. Back of black lacquered MDF. Wall suspension fittings of birch plywood included. Screws and rawlplugs for mounting not included. Caution: as solid wood reacts to damp or dry air, the mirror should not be placed in extreme indoor climate conditions.

Modeldetails

0,029 m³ Packaging dimensions:
7 kg / L: 69 cm W: 70 cm H: 6 cm
3,8 kg

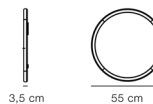

Essential Assortment

Item number	Frame	Price
832113	Oak light oil	591
832111	Walnut oil	708

Model 8320

Silhouette Mirror Ø100 cm

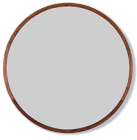

Designed by OEO Studio, 2020

Mirror with frame in solid wood. 4 mm mirror glass. Back of black lacquered MDF. Wall suspension fittings of birch plywood included. Screws and rawlplugs for mounting not included. Caution: as solid wood reacts to damp or dry air, the mirror should not be placed in extreme indoor climate conditions.

Modeldetails

0,08 m³ Packaging dimensions:
20 kg / 12 kg L: 114 cm W: 116 cm H: 6 cm

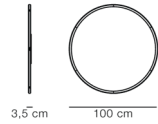

Essential Assortment

Item number	Frame	Price
832013	Oak light oil	1.083
832011	Walnut oil	1.166

Model 8322

Silhouette Mirror 70x70 cm



Designed by OEO Studio, 2020

Mirror with frame in solid wood. 4 mm mirror glass. Back of black lacquered MDF. Wall suspension fittings of birch plywood included. Screws and rawlplugs for mounting not included. Caution: as solid wood reacts to damp or dry air, the mirror should not be placed in extreme indoor climate conditions.

Modeldetails

0,04 m³ Packaging dimensions:
11 kg / 7 kg L: 82 cm W: 80 cm H: 6 cm

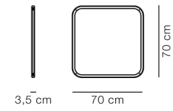

Essential Assortment

Item number	Frame	Price
832213	Oak light oil	833
832211	Walnut oil	999

Model 8324



Silhouette Mirror 70x180 cm

Designed by OEO Studio, 2020

Mirror with frame in solid wood. 4 mm mirror glass. Back of black lacquered MDF. Wall suspension fittings of birch plywood included. Screws and rawlplugs for mounting not included. Caution: as solid wood reacts to damp or dry air, the mirror should not be placed in extreme indoor climate conditions.

Modeldetails

0,09 m³ Packaging dimensions:
30 kg / 16 kg L: 191 cm W: 83 cm H: 7 cm

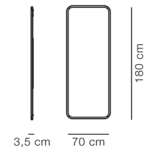

Essential Assortment

Item number	Frame	Price
832413	Oak light oil	1.416
832411	Walnut oil	1.583

**Model
F1090**

Fredericia Care Kits
Fredericia Care Kits



All Fredericia Care Kits are packaged in a brown cardboard box and includes necessary cloths or sponges for one treatment. Instructions are enclosed and can also be downloaded through fredericia.com.

Order configuration

Wood oil	Wood light oil	Wood soap
35	35	35

Material Samples

All prices are excl. VAT and shipping costs

PRODUCT	SIZE	PRICE EUR
Sample kits		
Sample Box, full collection	275 x 315 x 110 mm	429
Sample Organizer, small	260 x 315 x 70 mm	221
Leather sets		
Leather card	A4 fold-out	22
Saddle leather, set of 3 pcs	70 x 150 mm	15
Leather Hanger, Gr. 0+1	A5	67
Leather Hanger, Gr. 2	A5	67
Leather Hanger, Gr. 3+4	A5	98
Leather, single samples		
A5, Leather Gr. 0-2	A5	6
A5, Leather Gr. 3-4	A5	9
75x55mm, Leather Gr. 0-2	75x55mm	4
75x55mm Leather Gr. 3-4	75x55mm	4
Saddle leather	75x55mm	4
Sheepskin	75x55mm	4
Fabric, single samples		
Texture sample, standard fabrics*	75x55mm	3
Canvas & Linen webbing	75x55mm	2
Wood		
Wood Retail Display w. 10x10cm solid wood samples	360x130x60mm	280
Single wood sample, small	75x55mm	7
Single wood sample, large	100x100mm	11
Metal	75x55mm	4
Laminates / linoleum	75x55mm	5
Stone		
Stone Retail Display w. 10x10cm solid stone samples	360x130x60mm	251
Single graphic stone sample, small	75x55mm	4
Single solid stone sample, large	100x100mm	22
Pato Colours		
Pato Colour reference	75x55mm	4
Pato Polypropylene	60x100mm	5
Product selections		
Calmo selection hanger	A5	103
EJ315 & Corona selection hanger	A5	103
Ditzel lounge selection hanger	A5	103

*Available in one colour only

For other material & surface samples, please contact Customer Care & Quality at customerservice@fredericia.com

Fredericia Furniture A/S

Treldevej 183
7000 Fredericia

info@fredericia.com
+45 7592 3344



fredericia.com